



The Professional Audio

SourceBook

Section 14

Studio Furniture & Accessories

Auralex	1378-1390
Furman	1391-1397
Middle Atlantic	1398-1406
Omnimount.....	1407
Quik Lok.....	1408-1413
Raxxess	1414-1432
Ultimate.....	1433-1439

AURALEX ACOUSTICS

ROOMINATORS

STUDIO ACCESSORIES

1378

Complete Acoustical Control Kits

People are always looking for better sound. The trouble is, without fixing your room acoustics, none of your equipment will sound as good as it should. Your room won't let your gear's true sound come through. Auralex has taken the guesswork out of acoustics and made it easy and affordable to improve your sound. Auralex offers four Roominators kits that can easily tame the sound problems many people run up against in commonly-sized rooms. Everyone from the novice to the pro can sound their best....no formulas, no mumbo jumbo, no physics required. Now you can have the big studio sound you've been looking for, but didn't know where to find and probably thought you couldn't afford. Auralex has packed the Roominators kits with the same exact features and performance that many famous clients have loved for years.

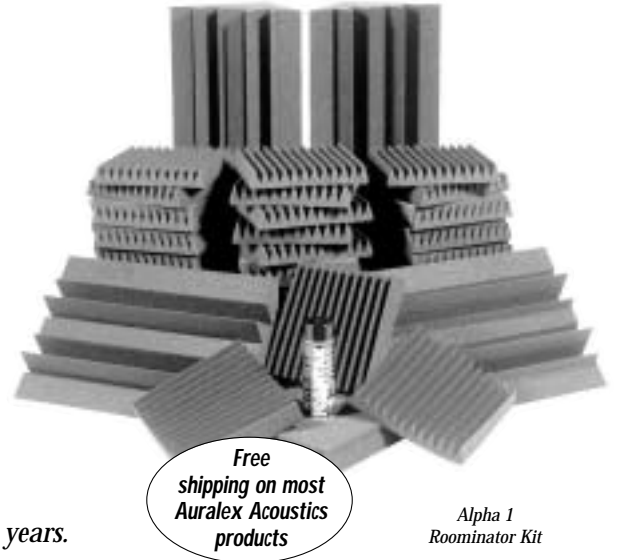

Roominators Kits contain:

Studiofoam 2" Wedge Panels or Wedgies (Alpha1) to absorb early reflections and kill that hollow, "ringy" room sound.

LENRD Bass Traps to smooth out rooms' inaccurate and excessive low frequencies.

Foamtak or TubeTak Adhesive to mount Studiofoam and LENRDs with minimum hassles.

T'Fusor 3D Sound Diffusors (Deluxe and Pro Kits only) for that spacious ambience and wide sweet spot big-name studios have.

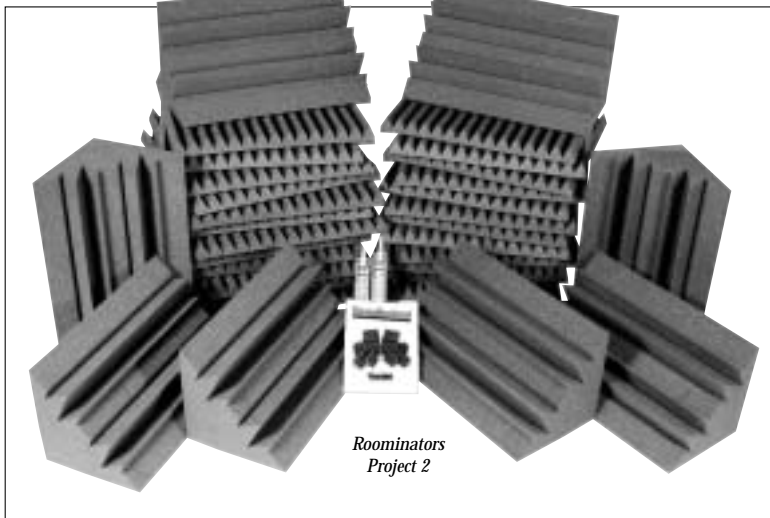

- ◆ Improve the sound of everything you record, listen to or mix
- ◆ Reduce your monitoring volume - yet actually hear better
- ◆ Hear more of the subtle sonic details that your room's inaccurate reflections have been burying
- ◆ Achieve better sound out of your existing equipment
- ◆ Improve your engineering skills, be more creative and get more enjoyment out of your equipment and your room!

Alpha1 Roominators Kit

- (64) 1' x 1' x 2" Wedgies
- (4) LENRD Bass Traps
- (1) Foamtak Spray Adhesive
- Alpha 1**Call

Roominators Project2

- (24) Studiofoam 2' x 2' x 2" Wedge Panels
- (8) LENRD Bass Traps
- (5) TubeTak Pro Liquid Adhesive
- Project 2**Call

Roominators Deluxe Plus

- (24) Studiofoam 2' x 2' x 2" Wedge Panels
- (8) LENRD Bass Traps
- (6) T'Fusor 3D Sound Diffusors
- (2) Foamtak Spray Adhesives
- Deluxe Plus**Call

Roominators Pro Plus

- (36) Studiofoam 2' x 2' x 2" Wedge Panels
- (12) LENRD Bass Traps
- (8) T'Fusor 3D Sound Diffusors
- (3) Foamtak Spray Adhesives
- Pro Plus**Call

Roominators are available in charcoal gray.



For Any Inquiries Regarding Your Order, Call Our Customer Service:
(800) 221-5743 • (212) 239-7765 • FAX: (800) 947-2215 • (212) 239-7549

AURALEX ACOUSTICS

Free shipping on most Auralex Acoustics products

It's never been this easy or affordable to tame the acoustics in your small studio, iso room, voiceover booth or control room. Each kit includes instruction sheets with installation suggestions.

If you're the type who doesn't know a lot about the physics of sound control.....and doesn't WANT to know a lot about the physics of sound control.... then you owe it to yourself to check out all the Roominators kits: from the super-affordable Alpha 1 up to the top-of-the-line Pro Plus Kit. And, if you ever need to, simply add more Roominators kits as your budget and acoustical needs dictate.

See the chart below for some rough guidelines to help steer you toward the kit that's just right for you. And, if your needs dictate, don't forget that you can also "mix and match" your room's solutions by combining more than one Roominators kit (of the same or different types) or by adding some of the other Auralex sound control products.

Roominators Kit	Square Footage (Area)	Shortest Room Dimension
Alpha 1	≤ 100'	6-8'
Project 2	≤ 100'	8-12'
Deluxe Plus	100-250'	10-14'
PRO Plus	250-400'	12-16'

ROOMINATORS

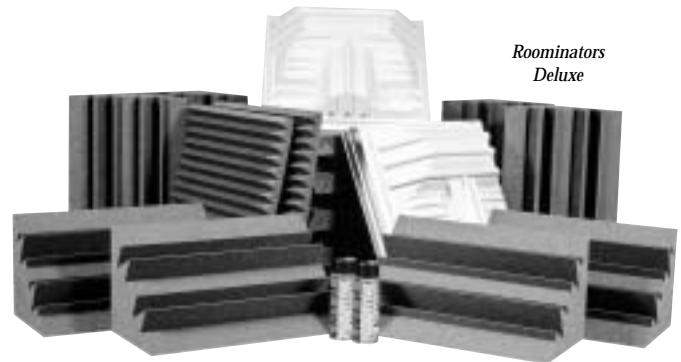

Roominators Deluxe

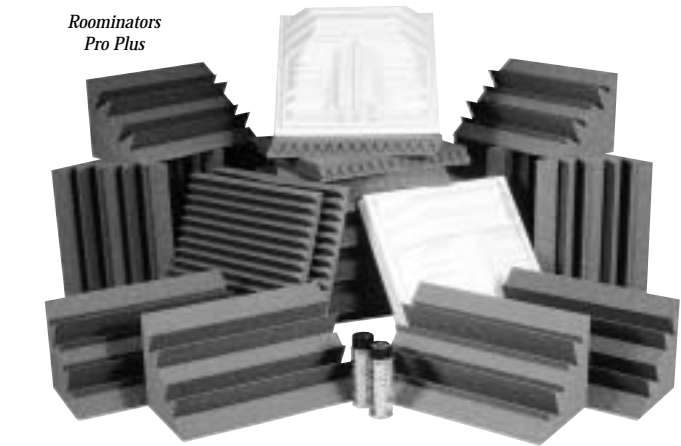

Roominators Pro Plus

STUDIO ACCESSORIES

1379

ADHESIVES

TubeTak Pro Liquid Adhesive

TubeTak Pro is a super-strong, permanent bonding adhesive that applies easily with a standard caulking gun or the optional TubeTak Pro Applicator. One tube mounts up to 32 square feet of foam or diffusors, depending on thickness.



Foamtak Spray Adhesive

The fast and easy way to mount foam products. Unlike TubeTak Pro, which is a more permanent adhesive, Foamtak can be applied lightly so that your foam is removable, or it can be applied heavily for a more permanent bond. Foamtak offers greatly improved long-term bonding power, is guaranteed not to oxidize Auralex acoustic foams, and mounts approximately 96 square feet, depending on foam thickness.



Vel-X Mounting

Vel-X panels are 22" square corrugated polypropylene panels that temporarily mount Auralex acoustic foam or MetroFusors on walls. The foam is adhered to the Vel-X panels with TubeTak Pro adhesive, then special Velcro dots are used to stick the panels to the wall. The panels are movable at will, allowing you to tune the room for a particular project or take them with you when relocating to a new facility. Vel-X panels are shipped with both TubeTak Pro and special Velcro dots. Minimum shipment is twelve 22 x 22" panels. Please note that 1" needs 40 panels per box of foam, 2" needs 24 panels per box of foam, 3" needs 16 panels per box of foam and 4" needs 12 panels per box of foam.

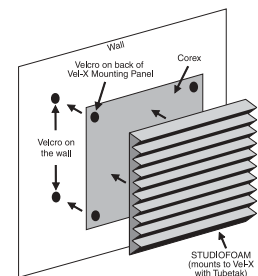

AURALEX ACOUSTICS

STUDIOFOAM

STUDIO ACCESSORIES

1380

Wedges and Pyramids

Studiofoam Wedges offer excellent absorption, a sleek, high-tech look and minimal installation seaming. They come in many colors and are available in 1, 2, 3 and 4" thicknesses and 2' x 4' sheets. Each sheet is precision-cut for clean-looking installations, so you won't find any innies or outies, or have to hassle with out-of-square panels. Consistency, increased flame retardancy, industry-leading absorption and a longlasting formulation add up to make Studiofoam wedges the hands-down value leader in the acoustics marketplace.

Studiofoam Pyramids offer a perfect combination of precision appearance and great sound control. With valleys running in both directions, they offer increased installation versatility (each pyramid is either 2" or 4" wide, making it simple to cut) minimal seaming, supply extra diffusion due to their 4-sided geometry and give your space tasteful, upscale looks and sound. Studiofoam Pyramids are manufactured in 2" and 4" thicknesses in 2' x 4' panels and are available in many colors. As they have less foam mass than Studiofoam wedges, Studiofoam Pyramids perform about 85% as well as Studiofoam wedges, but still outperform many competing brands.

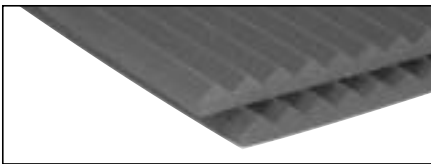
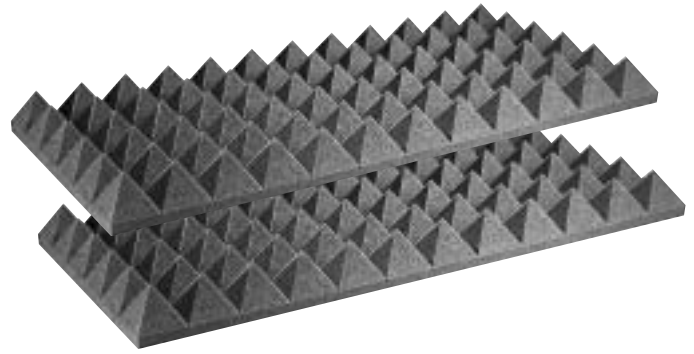

1" Studiofoam Wedges

Perfect for environments that require good sound control, but where total dryness isn't required. 1" Studiofoam works most effectively on mid and high frequency sound waves and may be used to treat walls or, more commonly, ceilings (especially if they aren't parallel to the floor), even when the walls are treated with thicker Studiofoam. 1" Studiofoam absorbs as well as some competing 2" products, so if your budget is a bit thin, 1" Studiofoam might be just the ticket for you.

NRC: .50 **Qty:** 20 panels **Coverage:** 160 sq. ft. **Suggested adhesive per box:** 2 Foamtak or 5 TubeTak

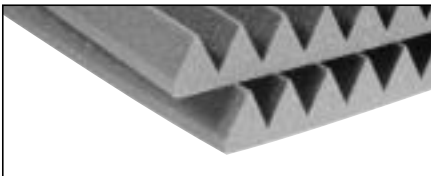

2" Studiofoam Wedges

2" Studiofoam Wedges are Auralex's most popular seller and best overall performer. Use them to treat small- to medium-sized areas including vocal booths, control rooms and studios. They effectively kill standing waves and flutter echoes and, when used in conjunction with bass traps, or broadband absorbers, can effectively tame the full frequency bandwidth in virtually any room. 2" Studiofoam is the workhorse of the industry and is your safest bet if you're tuning your room without the help of a professional acoustician.

NRC: .80 **Qty:** 12 panels **Coverage:** 96 sq. ft. **Suggested adhesive per box:** 1 Foamtak or 3 TubeTak

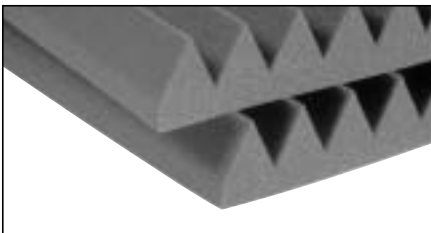

3" Studiofoam Wedges

Twice as absorbent as 2" at 125Hz, 3" can do many of the same things 4" can do (especially when used with LENRD or Venus Bass Traps) and can provide a well-controlled, more accurate sound in any size room. Recommended for rooms with higher SPLs or more low frequencies such as drum or voiceover booths. Many rooms have low-end problems, so if you step up from 2" to 3", you will benefit from the extra low-end absorption 3" Studiofoam Wedges offer.

NRC: .90 **Qty:** 8 panels **Coverage:** 64 sq. ft. **Suggested adhesive per box:** 1 Foamtak or 2 TubeTak

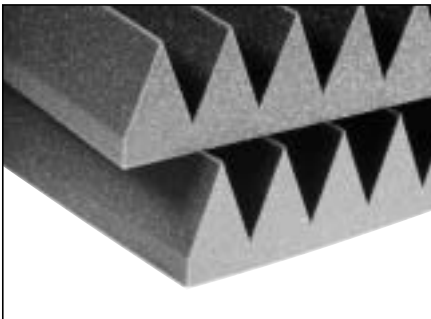

4" Studiofoam Wedges

Recommended for medium to large areas like concert halls, gymnasiums and churches, rooms with pronounced low frequency problems or where sonic accuracy is mandatory and maximum absorption is required (e.g. voiceover or drum booths, forensic audio labs and mastering rooms). 4" Studiofoam Wedges provide 3x the low-end control of 2" and can effectively tame even the worst sonic anomalies. In some instances, using 4" Studiofoam can lessen the need for significant dedicated bass trapping.

NRC: 1.10 **Qty:** 6 panels **Coverage:** 48 sq. ft. **Suggested adhesive per box:** 1 Foamtak or 2 TubeTak



EQUIPMENT LEASING AVAILABLE

AURALEX ACOUSTICS

STUDIOFOAM

2" Studiofoam Pyramids

Use these to treat small- to medium-sized areas including iso booths, control rooms and studios. They effectively kill standing waves and flutter echoes and, when used in conjunction with LENRD or Venus Bass Traps or Sunburst Broadband Absorbers, can tame the full frequency bandwidth in virtually any room. 2" Studiofoam Pyramids offer a bit of extra diffusion and slightly less absorption than 2" Studiofoam Wedges, so they yield a less dry-sounding space with a bit more "air."

NRC: .70 Qty: 12 panels Coverage: 96 sq. ft.
Suggested adhesive per box: 1 Foamtak or 3 TubeTak

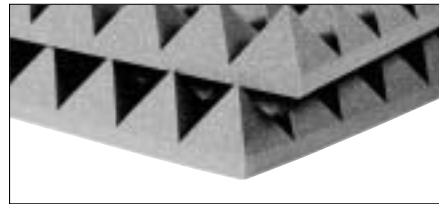
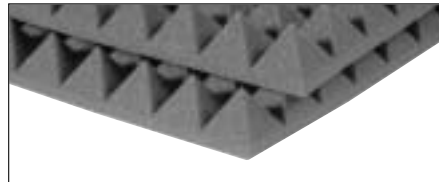

4" Studiofoam Pyramids

As with 4" Studiofoam Wedges, these 4" Pyramids are recommended for larger spaces, rooms with pronounced low frequency problems or where sonic accuracy is mandatory and stronger absorption is required. Having 4 sides exposed on each pyramid also yields more sound wave diffusion, which is desirable in some spaces. Thus, 4" Studiofoam Pyramids will yield less overall dryness than 4" Studiofoam Wedges.

NRC: .95 Qty: 6 panels Coverage: 48 sq. ft.
Suggested adhesive per box: 1 Foamtak or 2 TubeTak

Sonomatt Acoustic Panels

The perfect product for the budget-conscious, yet acoustically-discerning customer. Sonomatt is cut in the industry standard "eggcrate" style to keep its price low and absorbs almost as well as 2" Studiofoam Wedges, yet outperforms "premium" brands that cost way more. Please note that Sonomatt's dimple pattern will not be square to the edges of the panels, so installing them side by side may not be advised from a visual standpoint. Sonomatt is available in charcoal gray in 2' x 4' and 4' x 8' sheets and it may be the perfect choice for those who intend to cover their sound control materials with acoustical cloth.

Sonomatt 2 x 4Call **Sonomatt 4 x 8**Call

NRC: .70 Qty: 12 2x4's (96 sq. ft.) or 2 4x8's (64 sq. ft.)
Suggested adhesive per box: 1 Foamtak or 3 TubeTak

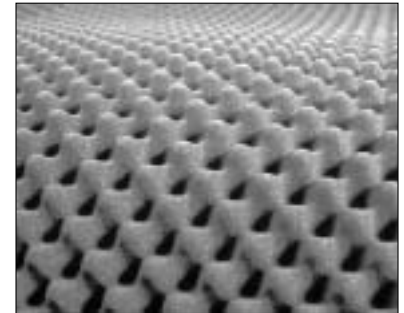
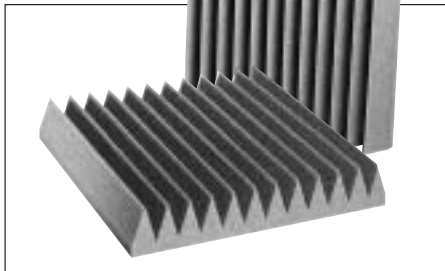

Wedgies

Wedgies are 1' squares of 2" thick Studiofoam and are a great solution for spot treating studios, home listening rooms, iso booths and more. With slightly more wedges per square foot than 2" Studiofoam, Wedgies feature maximized surface area for greater exposure to sound waves. Wedgies are a great solution for small flutter echo problem areas and, when spread apart a little bit, yield beneficial diffusion off their exposed edges. Available in charcoal gray only.

Wedgies, box of 24Call **Wedgies, box of 96**Call

NRC: .75 Qty: 24 or 96 Coverage: 24 or 96 sq. ft.
Suggested adhesive per box: 1 Foamtak or TubeTak/24 sq. ft. - 1 Foamtak or 3 TubeTak/96 sq. ft.

PLATFOAM

HoverDeck Structural Isolation System

- ◆ Decouples drums/amps/speakers from the room
- ◆ Significantly increases isolation, minimizing sound transfer to areas outside the studio
- ◆ Improves purity of tone and crispness of instruments
 - ◆ 2" x 4" x 4" pieces of high density foam
 - ◆ 24 pieces per box (will float an 8' x 8' area)

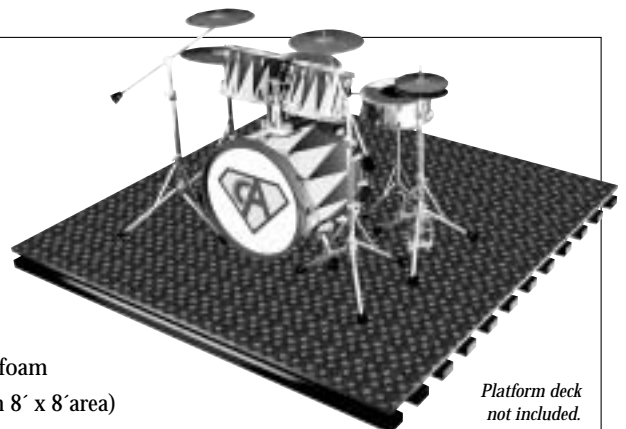

Platform deck not included.

PLATFOAM

STUDIO ACCESSORIES

1381

AURALEX ACOUSTICS

METRO FAMILY

Free shipping on most Auralex Acoustics products



STUDIO ACCESSORIES

1382

The Metro Family blurs the line between those products that work well acoustically and those that yield the desired aesthetics that users desire. The Studiofoam Metro and the MetroFusor Diffusor afford minimal installation seaming because the left and right edges of the panel are the same height. They lend themselves to a variety of installations that look great and sound quite natural due to Metro's linear — and moderate — acoustical action.

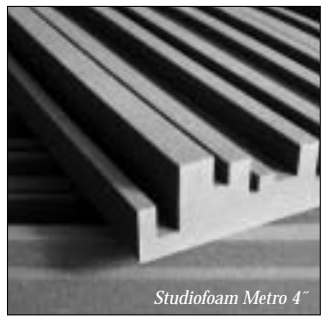

Studiofoam Metro 4"

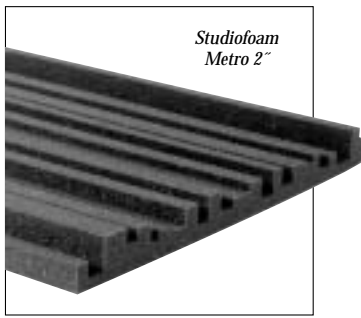

Studiofoam Metro 2"

Studiofoam Metro

The differing heights of protrusions on the Studiofoam Metro spreads sonic energy out in the time domain, as well as each absorbing a slightly different slice of the frequency spectrum. It takes slightly different amounts of time for sound waves to travel through the different sections of the Metro, strike the mounting surface and travel back into the room, so wavefronts are in effect softened rather than just being absorbed. This is why a Metro room will retain a bit more "feel" than a room that's treated with a stronger absorber like 3" or 4" Studiofoam Wedges or Pyramids and why, when coupled with a judicious amount of MetroFusors, a well-controlled, natural-sounding space will result.

Studiofoam Metro 2"

NRC: .70 **Qty:** 12 panels **Coverage:** 96 sq. ft. **Panel Size:** 2' x 4' x 2"
Suggested adhesive per box: 1 Foamtak or 3 TubeTakCall

Studiofoam Metro 4"

Qty: 6 panels **Coverage:** 48 sq. ft. **Panel Size:** 2' x 4' x 4"
Suggested adhesive per box: 1 Foamtak or 2 TubeTakCall

MetroFusor Sound Diffusor

As a companion to the well-received Metro 2" Absorber and Metro LENRD Bass Trap, Auralex has developed the MetroFusor. It's custom made from high quality EPS (expanded polystyrene), so it's lightweight, affordable, easy to paint, easy to mount and inexpensive to ship. It features the same distinctive, proprietary surface contour as the Metro Absorber for a clean, consistent, architecturally-pleasing appearance that looks upscale and attractive in even the most highbrow of environments. The MetroFusor's surface contour yields both sound wave refraction AND time domain spread for improved modal response without removing a significant amount of sonic energy from your space. It's perfect for churches, boardrooms, performance venues, studios and more. It's also a significant bass trap below 400Hz, which is quite a desirable attribute (because low frequency diffusion would only muddy your sound).

Quantity: 12 **Size:** 2' x 2' **Coverage:** 48 sq. ft. **Suggested adhesive per box:** 2 TubeTak

Metro LENRD Bass Traps

Metro LENRD Bass Traps round out the Auralex Metro family. This triangular-shaped bass trap fits into room corners and/or wall/ceiling junctures perfectly, and provides outstanding broadband absorption (especially at low frequencies). Based on the design of the wildly successful original LENRD Bass Trap, the Metro LENRD gives a fresh look to a reliable, unbeatable sound absorber. Plus, it's available in 12 colors.

All three Metro products work together to provide sound absorption, diffusion and bass trapping, while the "cityscape" cut provides visual continuity to your room. The Auralex Metro family was designed with a professional, architectural look for use in studios, classrooms, home theaters, office buildings, churches or anywhere a more upscale appearance is called for.

Quantity: 8 **Coverage:** 16 lineal feet **Size:** 2' x 1' x 1'
Suggested adhesive per box: 1 Foamtak or 2 TubeTak

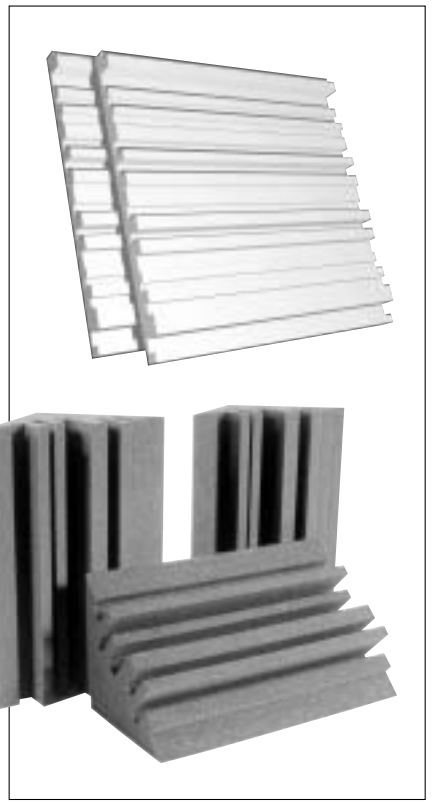

AURALEX ACOUSTICS

DIFFUSORS

In Which Rooms and Which Placement Is Diffusion Appropriate?

First of all, control rooms. Most studio designers will tell you that the front of the room (walls and ceiling) should be absorptive as far back as the engineer. The ceiling from the engineer back can contain a mix of diffusion and absorption, but many top designers feel the rear wall should feature a diffusor array surrounded by broad bandwidth absorption, especially in larger rooms. The side walls and ceiling from the engineer's position on back can be alternately absorptive and diffusive.

Second, live rooms (studios). Personal taste, room size and room function determine how dry (absorptive) or wet (diffusive) a studio should be, but many famous rooms are absorptive in some spots and diffusive in others. Generalizations: rock studios should be more absorptive than classical or jazz studios, and rarely should they be totally "dead." If you've got to be in a wet room, have the liveliness controlled by diffusion to yield a more pleasing and smoother overall room sound and reverb tail (decay).

Third, isolation and voiceover booths. Personal taste and room size come into play here, too. A voice talent sounds great in totally absorptive environments, while a drummer may prefer a combination of diffusion and absorption on all room surfaces with significant bass trapping. When recording sax players, violinists or solo sopranos, you might want some combination of the two; probably more diffusive than absorptive. It's truly your call, but bear in mind that once bad (non-diffused) "room sound" is captured on tape, disk, etc., you can never get rid of it.

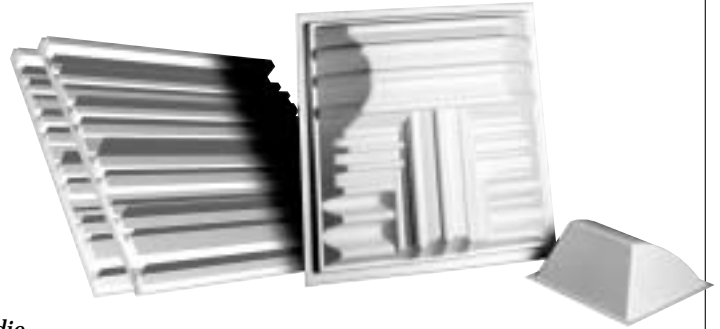

Free shipping on most Auralex Acoustics products

T'Fusors

Made from high-impact thermoplastic resin, T'Fusors, which are 23.75" square, drop perfectly into a suspended ceiling grid, and stand up very well to normal wear and tear. They are lightweight and nest into each other, dramatically lowering shipping costs.

T'Fusors mount easily to walls and ceilings using construction adhesive or mechanical fasteners, and are sized to facilitate alternating them with acoustic foam panels for better overall room sound. They have a 1" ledge in their back that permits insertion of SheetBlok, flat-cut acoustic foam, rigid fiberglass or Auralex Mineral Fiber insulation for greater versatility. They're available in easily paintable white.



MiniFusor Sound Diffusor

Just like its big brother the T'Fusor, the MiniFusor is very versatile and affordable. Its shape lends itself to various wall patterns and its cavity can be filled

with acoustic foam or Auralex mineral fiber insulation to provide better diffusion and low frequency trapping. It is made from rigid thermoplastic resin and, like the T'Fusor, is super-easy to mount and paint. Auralex MiniFusors offer a rare combination of great performance and a great price. So, if you're in the market for diffusers and are on a tight budget, you owe it to yourself to give serious consideration to a MiniFusor array. MiniFusors are 12" x 12" x 5" and have a quantity of 12 per box (12 sq. ft.).

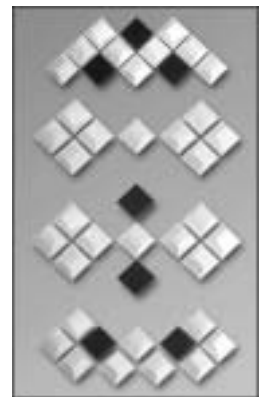

Four MiniFusor array suggestions shown with Wedgies

Where, and In What Quantities, Should You Install T'Fusors?

In most small control rooms it is recommended to install a group of at least 4 T'Fusors on the rear wall. Larger control rooms get at least four additional T'Fusors on the rear wall and, optionally, additional units placed on the ceiling from the mix position back. Discretionary placement: side walls behind the mix position, alternating with acoustic foam. Regardless of room size or function, groups of less than 4 T'Fusors are not audibly worthwhile. Also, for T'Fusors to work properly, the pattern should not repeat sideways or vertically in close proximity to itself.

AURALEX ACOUSTICS

LENRDS

STUDIO ACCESSORIES

1384

Free shipping on most Auralex Acoustics products

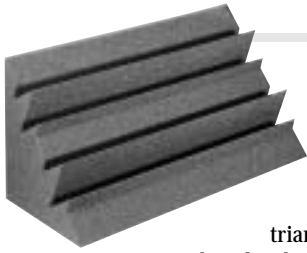

LENRD Bass Traps

Low frequency sound waves are the most prominent and difficult to control, whether you're attempting to block their transmission to a neighboring space or trying to absorb them to clean up the low frequency response. LENRD's triangular shape traps bass buildup by putting a big chunk of Studiofoam right where you need it: in your trihedral corners (where two walls come together and meet the ceiling).

Each LENRD kit contains eight 2' tall LENRDs, enough to trap 16 lineal feet. If you've got 8' ceilings, one box would be enough to trap both your room's rear corners floor to ceiling. Or, if space permits, you could trap all four corners of your room from the ceiling down 4'. Due to LENRD's efficiency, you can achieve premium results by utilizing thinner Studiofoam for the bulk of your wall treatment.

Suggested Adhesive: 1 Foamtak or 2 TubeTak per box
Standard LENRD NRC: 1.35

MegaLENRD

At twice the width (extending 2' along each wall, not 1' like the standard LENRD), the MegaLENRD is substantial enough to handle low frequency problems in rooms of any size.

Quantity Per Box: 2 **Colors:** All

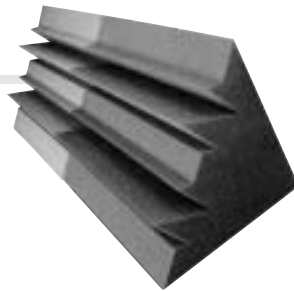

Stand-Mounted LENRDs

Stand-Mounted LENRDs are 4' tall instead of the standard 2', and come complete with the same stands utilized with Sunburst-360s. In "normal" mode, the LENRDs stand about 6' tall, but in "extended" mode, they can reach heights of nearly 8' or more. Stand-Mounted LENRDs are the perfect complement to MAX-Wall Modular Acoustical Environment. They're portable, effective, highly affordable and because they're stand-mounted, there's no adhesive to worry about and no wall repair to do if you move and take them with you.



LENRD NRC: 1.35

Quantity Per Box: Four 4' LENRDs complete with 4 MAX-Stands
Colors: Charcoal gray, vivid purple and burgundy

VENUS BASS TRAPS

Venus Bass Traps

Many smaller studios and control rooms suffer from low frequency anomalies not only due to their lack of adequate trapping in general, but also due to their dimensions. Therefore, you may have tons of bass one place, but if you move 6", you've got none at all.

In a studio, it's easy enough to move a performer, amp or drum kit to a different spot. But in a control room, where everything's fixed in location, such standing wave occurrences become tougher to deal with....and much more important based on the nature of what a control room is for. The Venus achieves a prodigious level of low frequency absorption at your room boundaries—

where low frequency problems begin. It exhibits a phenomenal coefficient of 1.63 at 125Hz, and ships in a 2' x 4' x 12" size. It is often cut in half to 2' x 2', then paired with a 12' Auralex CornerFill. Venus not only works well in smaller rooms, it really shines in larger rooms like gymnasiums, houses of worship and multipurpose rooms.

NRC: 1.30 Qty: 2 (16 sq. ft.) **Suggested Adhesive Per Box:** 1 Foamtak or 2 TubeTak

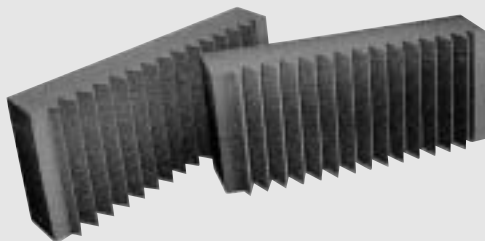
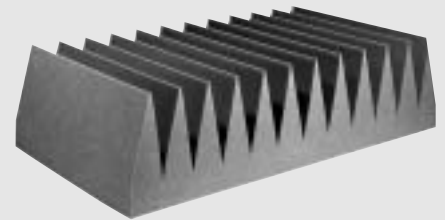

MegaMAX

Sometimes, studios or tracking rooms have very pronounced bass anomalies that can't be totally mitigated by conventional placement of bass traps. The 2' x 4' MegaMAX panels are 9" thick and have a hole cut through them so that they can be mounted on MAXStands, enabling them to be moved easily to "fine tune" difficult low-end problems. Their portability allows them to be used as low frequency go-bo's. The MegaMAX can be placed in problematic areas unique to particular applications.

NRC: 1.10, 1.32@125Hz **Qty:** 2 (16 sq. ft.) **Adhesive and MAX-Stands are optional**



ONE HOUR FREE PARKING

AT 349 W. 34th STREET (with purchase of \$100 or more)

AURALEX ACOUSTICS

SUNBURSTS



Sunburst Broadband Absorbers

Sunbursts feature a smart and unique male/female configuration that helps solve quite a wide range of acoustical problems. Because they offer a significant amount of both low frequency control in particular and broadband absorption overall, they work well in rooms that don't have corners available for treatment with LENRDs or where you don't need or desire large expanses of absorbent wall or ceiling treatment. (In other words, Sunbursts work well in

rooms where you desire control but don't want too dry a sound, or in rooms where you don't have a lot of wall or ceiling space available for treatment.) Sunburst Females are often cut in half and used as "mini-LENRDs" or to frame Studiofoamed areas. They look great and deliver truly linear broadband performance. (They're virtually flat!) Sunbursts contain 4 males and 4 females per box; males are 1' x 4' x 7". Instructions and suggestions are included.

NRC: 1.10 (male yields 1.08 at 125Hz) **Size:** 1' x 4' x 7"

Quantity Per Box: 4 males and 4 females (32 lineal feet) **Suggested Adhesive Per Box:** 1 FoamTak or TubeTak

The Sunburst-360 Eclipse Acoustical Environment

Sunburst-360s are wedge-cut, elongated, stand-mounted absorbers that offer adaptability, portability and affordability. When placed around a vocalist, instrumentalist, voice talent or control room mix position, they form an Eclipse Acoustical Environment, yielding superior broad bandwidth control of reflected sound waves in the nearfield and low frequency waves in the room in general. Sunburst-360s are so linear in their absorption that they exhibit a deviation of only ± 1.9 Sabins across the entire test frequency spectrum from 100Hz to 5000Hz. This is the linear absorber the acoustics marketplace has been searching for all these years. With an Eclipse Acoustical Environment, you can quickly, easily and affordably achieve world-class sound control in any environment. Sunburst-360s are shipped with 2 males and 4 females per box; males are 12" x 15.5" x 4'. 2 MAX-Stands with 18" extensions per box, allowing height of 4' 6" to 9'. Available in charcoal gray, vivid purple and burgundy colors.

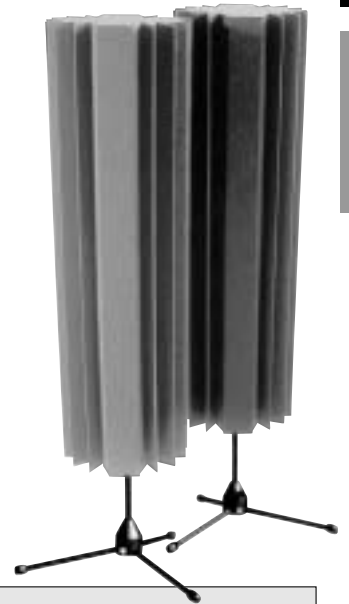

BRIEF DEFINITIONS and STATISTICS

NRC (Noise Reduction Coefficient):

A numerical rating given a material which tells us how much airborne sound the material absorbs. This rating generally applies to soft materials like acoustic foam, fiberglass, fabric, carpeting, etc. but also applies to much lesser degrees to harder materials like brick and drywall. A material's NRC is an average of its absorption at various center frequencies between 125Hz and 4000Hz. The higher the number, the better an absorber the material is.

STC (Sound Transmission Class):

A numerical rating of how effective a material is at blocking the transmission of sound through itself. This rating generally applies to hard materials like rubberized sound barriers, concrete, brick and drywall but also applies to a much lesser degree to softer materials like mineral fiber (although it isn't tested by itself; it's tested as part of a wall system to verify its effectiveness). Virtually every material filters out some of the sound that travels through it, but dense materials are much better at this than are spongy materials.

AURALEX ACOUSTICS

CORNERFILLS

STUDIO ACCESSORIES

1386

CornerFills

CornerFills are sections of flat-cut Studiofoam that are beneficial in two ways. Aesthetically, they give you smooth, clean edges against which to butt your wall treatments and bass traps for a more professional appearance. Acoustically, they smooth out the excess low frequency energy that congregates in room corners. **Suggested Adhesive Per Box: 1 FoamTak or 1 TubeTak**

2" x 2" x 24" 36 per box (72 lineal ft.)Call 4" x 4" x 24" 9 per box (18 lineal ft.)Call
3" x 3" x 24" 16 per box (32 lineal ft.)Call 12" x 12" x 24" 1 per box (2 lineal ft.)Call

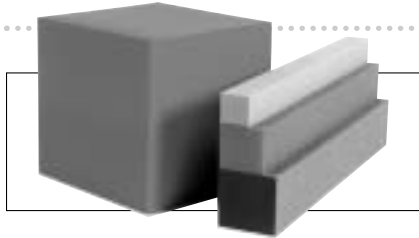
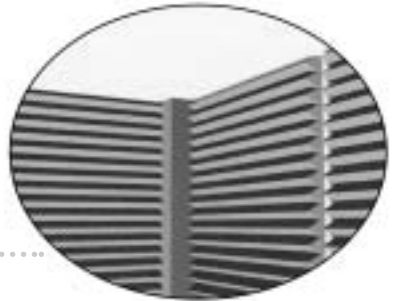

CornerFill Cubes

CornerFill Cubes are a terrific way to finish out trihedral corners where three LENRD Bass Traps come together. Simply install the Cornerfill Cube at the wall/ceiling juncture, then butt your LENRDs up to it for a finished, professional look and tons of additional low frequency absorption. Great for gyms and larger rooms. 12" x 12" x 12". 2 per box (2 lineal ft.).

ATOM-12

This kit consists of four 12" CornerFill Cubes and 12 LENRDs. Installation's a snap and what you end up with, in each trihedral corner of your room, is a configuration like the one pictured here. Installed in the "usual" way, LENRDs are the most effective small bass traps on the market and have no equal. But when you install them using 12" CornerFill Cubes, you're really going to have serious low frequency accuracy in your room. All rooms need low frequency smoothing. Trihedral corners (where two walls and the ceiling come together) are the places where physics amplifies bass the most. Given these facts, you can see why the ATOM-12 is a smart way to begin giving your room the bass trapping it needs.

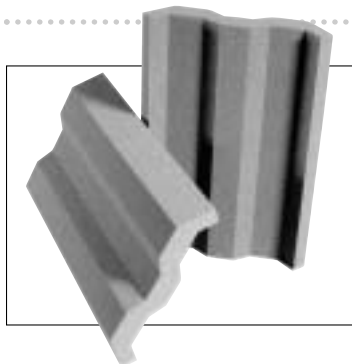
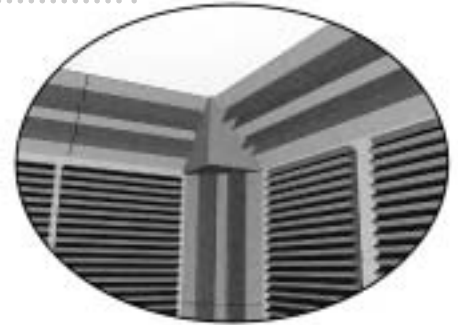

VersaTile

This next-generation broadband absorber combines a visually attractive absorptive panel with specially engineered air cavities that yield extraordinary sonic benefits. The VersaTile can be positioned to bridge a corner, creating a sizable air pocket that delivers great low frequency absorption. It can also be placed on walls and ceilings with either side out, allowing for some sophisticated looks while offering superior absorption characteristics versus thinner, flat acoustic foam panels. If room boundary space is limited, the VersaTile packs a ton of absorption into a minimal amount of cubic space.

Quantity: 6 or 24 panels **Coverage:** 16 or 64 sq. ft.

GRAMMA

gramma

GIG AND RECORDING AMP & MONITOR MODULATION ATTENUATOR

The Gramma is used to float an amp or loudspeaker and yields nearly total acoustic isolation, resulting in a purity of tone that has to be heard to be believed.

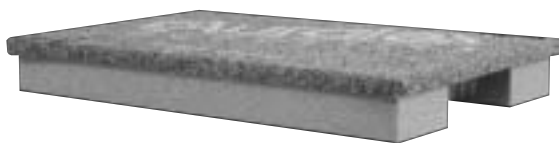

- ◆ Get your own personal amp/speaker riser
- ◆ Isolate and decouple your amp and/or monitors from the floor/stage, resulting in much greater separation and clarity
- ◆ Makes engineering much easier due to less bleed and resonance
- ◆ Dramatically improve audibility on-stage and in the studio
- ◆ 23" x 15" x 2 1/4" LWH
- ◆ 1 or 2 GRAMMAS will support most amps, speaker cabinets, subwoofers and monitors



AURALEX ACOUSTICS

MAX-WALL

MAX-Wall's are everything you've ever wanted from acoustical treatments — affordability, portability, expandability and adaptability. The interlocking MAX-Wall system can grow as your needs change. Add some Sunburst 360s or stand-mounted LENRD bass traps and you've got an incredible amount of acoustical control in a simple, portable package. MAX-Wall's are perfect if you don't want to mount anything to your walls, if your place needs to serve a variety of acoustical purposes or if you're on a budget. They offer great broadband absorption (even at low frequencies) and are incredibly linear, with an overall NRC of 1.05. It offers excellent broadband control of sound waves throughout your room and in the near field, so you can play, record or mix great music or vocal tracks anywhere, anytime.

The MAX-Wall panels are thick enough to yield a pretty high degree of sound containment, so a couple boxes of them can be used to set up a temporary pseudo-iso booth. It won't yield total sound isolation, but will give you enough containment so that you can lay down a clean new track in a hurry and likely not have to monitor on headphones.

STUDIO ACCESSORIES

1387



MAX-Wall 831

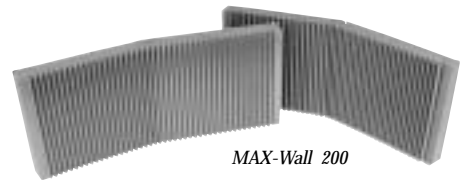

MAX-Wall 200

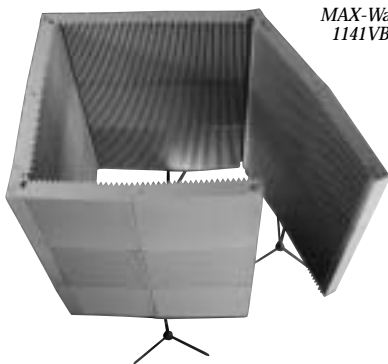

MAX-Wall 1141VB



MAX-Wall 420



MAX-Wall 633

MAX-Wall 200
2 - 20" x 48" MW-panels

MAX-Wall 211
2 - 20" x 48" MW-panels
1 - MAX-Stands
1 - MW-panel with 18" x 12" window

MAX-Wall 420
4 - 20" x 48" MW-panels
2 - MAX-Stands

MAX-Wall 521
5 - 20" x 48" MW-panels
2 - MAX-Stands
1 - MW-panel with 18" x 12" window

MAX-Wall 633
6 - 20" x 48" MW-panels
3 - MAX-Stands
3 - MW-panels with 18" x 12" window

MAX-Wall 831
8 - 20" x 48" MW-panels
3 - MAX-Stands
1 - MW-panel with 18" x 12" window

MAX-Wall 1141VB
11 - 20" x 48" MW-panels
4 - MAX-Stands
1 - MW-panel with 18" x 12" window
12 - MW Corner Couplers



MAX-Wall 211



MAX-Wall 521

Kits are available in charcoal gray, purple, or burgundy. MAX-Walls can be raised to 8' by mounting them on MAX-Stands that have an extension. MAX-Clips are included for added support. To match your MAX-Wall, MAXPak Studiofoam features the same wedge-cut design. Corner Couplers are available to join MAX-Walls at 90° angles. (The 1141 VB Kit includes Couplers). The MW-Window Kit can be purchased separately and includes a 48 x 20" panel with an 18 x 12" plexiglas-type window.

ORDER & INFO. (212) 444-5088 • FAX: (212) 239-7770 (800) 947-7008
1-800-875-6951 • www.bhphotovideo.com



AURALEX ACOUSTICS

DESIGNER SERIES

Free shipping on most Auralex Acoustics products

STUDIO ACCESSORIES

1388

Introducing the Auralex Designer Series

Auralex continues to lead the industry in acoustical performance with innovative products that the market demands. With the introduction of the new DST Designer Series, Auralex now offers DST versions of Studiofoam, LENRD, and Roominators with a more stylish look.

STUDIOFOAM DST

For the design-conscious looking for excellent absorption, a sleek, high-tech stylish look and minimal installation seaming, Studiofoam DST is for you! Available in 2 simple shapes, you can easily create a multitude of great patterns that adds a true designer-touch to your recording, listening or home theater environment at a great value.

DST-112

These 1'x1's provide a great design base, and can easily be cut in half to offer exciting combinations.

NRC: 0.60 **Qty:** 24 or 96 panels
Coverage: 24 or 96 sq. ft. **Color:** Charcoal Gray
Suggested Adhesive Per Box:
1 Foamtak or 3 Tubetak (per 96 sq. ft.)

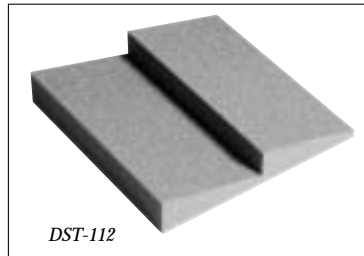

DST-114

The DST-114's are also 1'x1's that complement the 112's and other DST Studiofoam products. They can easily be cut in 3" shingles, allowing for many options when used singularly or with 112's.

NRC: 0.65 **Qty:** 24 or 96 panels
Coverage: 24 or 96 sq. ft.
Suggested Adhesive Per Box:
1 Foamtak or 3 Tubetak (per 96 sq. ft.)
Color: Charcoal Gray, Burgundy, Purple, Forest Green

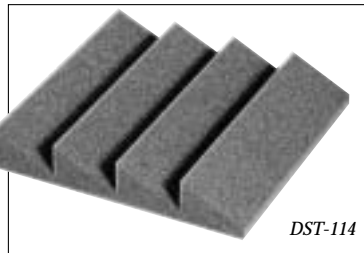

DST-244

The same cut as the DST-114, but in a 2' x 4' x 2" Studiofoam panel. The "shingle" contour allows you to easily cut them to create great designs.

NRC: 0.65 **Qty:** 12 2' x 4' panels **Coverage:** 96 sq. ft.
Suggested Adhesive Per Box: 1 FoamTak or 3 TubeTak
Color: Charcoal Gray, Burgundy, Purple, Forest Green

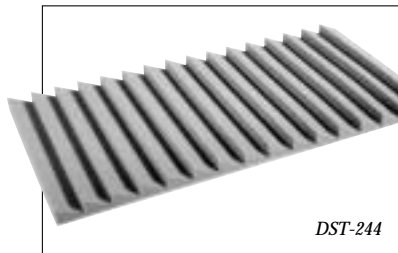

DST-422

The same cut as the DST-112, but running length-wise in a 4' x 2' panel. Create great borders that finish off almost all Auralex products by easily cutting them down to 6" x 48". If you "don't want it to look like foam", this is the product for you.

NRC: 0.60 **Qty:** 6 or 12 - 4' x 2' panels
Coverage: 48 or 96 sq. ft.
Suggested Adhesive Per Box:
1 FoamTak or 3 TubeTak (per 96 sq. ft.)
Color: Charcoal Gray, Burgundy, Purple, Forest Green

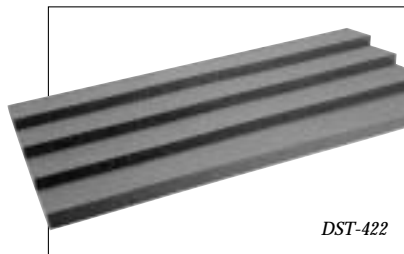

DST LENRD

Enjoy all the benefits of the ever-popular LENRD bass traps in a design that will make any DST install look stellar. When you need some low-end absorption, the DST LENRD is a great design alternativeCall

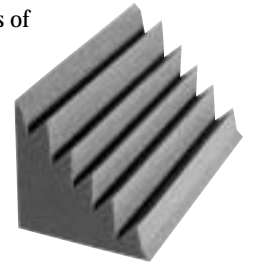

NRC: 1.20 **Qty. Per Box:** 8 (16 linear feet);
Colors: charcoal gray, burgundy, purple, forest green
Suggested Adhesive Per Box:
1 Foamtak or 2 Tubetak

DST-R

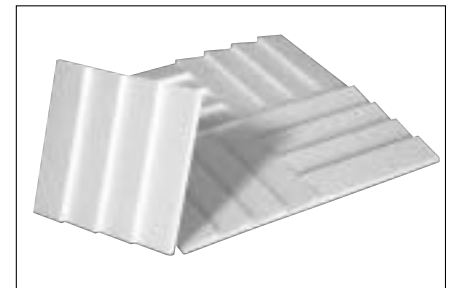

The newest member of the diffusor family is the Diffusive Sound Tile Reflector, or DST-R. Intended as the perfect compliment to the DST-112 and DST-114 Studiofoam Panels, they can be aligned in a number of ways to create a designer look. Only 1" thick, the DST-R is 1' x 1'. It is the same shape as a DST-114 panel, making it a great option when installation depth is limited, such as a low ceiling. Made from high quality EPS, the DST-R is lightweight, can be installed and painted easily, and is a very low cost diffusive alternative.

Qty: 36 per box **Size:** 1' x 1' x 1"
Coverage: 36 sq. ft.
Suggested Adhesives Per Box: 2 Tubetak



EQUIPMENT LEASING AVAILABLE

AURALEX ACOUSTICS

DESIGNER SERIES

ROOMINATORS DST

Roominator-DST Kits span a wide variety of applications, addressing the acoustic and aesthetic needs of the small project studio as well as the most demanding professional mix/mastering environments. Whether it's your first studio, a home theater, or a Pro Tools Suite, the Roominators-DST Kits are designed to dramatically improve your acoustics, and give you a great designer look.

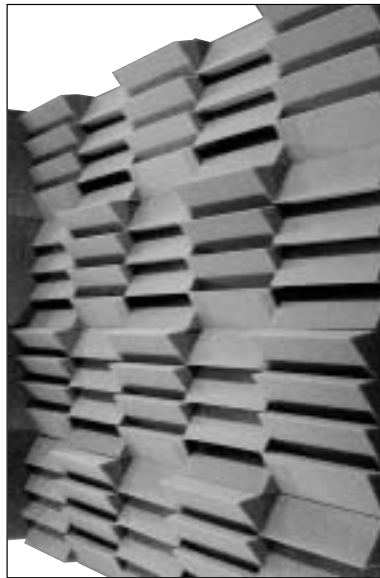

D240xi

D240xi Roominator DST Kit

The Big-Daddy of Roominator kits! It not only gives you plenty of product for superior acoustic performance, it provides all the components necessary for a fabulous look. It also includes a Gamma Isolation Riser and 10 MoPad Monitor Isolation Pads to properly isolate a sub-woofer and up to 5 monitors.

The kit includes:

- (48) DST-112 panels
- (12) DST-422 panels (96 sq. ft. in charcoal gray)
- (96) DST-114 panels in your choice of their 4 colors
- (16) DST-LENRD Bass Traps (charcoal gray)
- (12) T'Fusor 3D Sound Diffusors
- (6) Tubetak Pro Adhesives

D240xi Call

D36 Roominator DST Kit

Perfect for spot treatment. The D36 offers you a starting point to reduce unwanted slap and flutter echo in your room.

The kit includes:

- (18) DST-112 panels
- (18) DST-114 panels in your choice of their 4 colors
- (2) Tubetak Pro Adhesives

D36 Call

D108L Roominator DST Kit

All the components you need to attack the acoustics of a smaller Project Studio. Excellent for smaller home theaters. Two D108L kits may be appropriate for medium-sized studios and home theaters, as well as live rooms and rehearsal spaces.

The kit includes:

- (54) DST-112 panels
- (54) DST-114 panels in your choice of their 4 colors
- (8) DST-LENRD Bass Traps (charcoal gray)
- (6) Tubetak Pro Adhesives

D180L Call

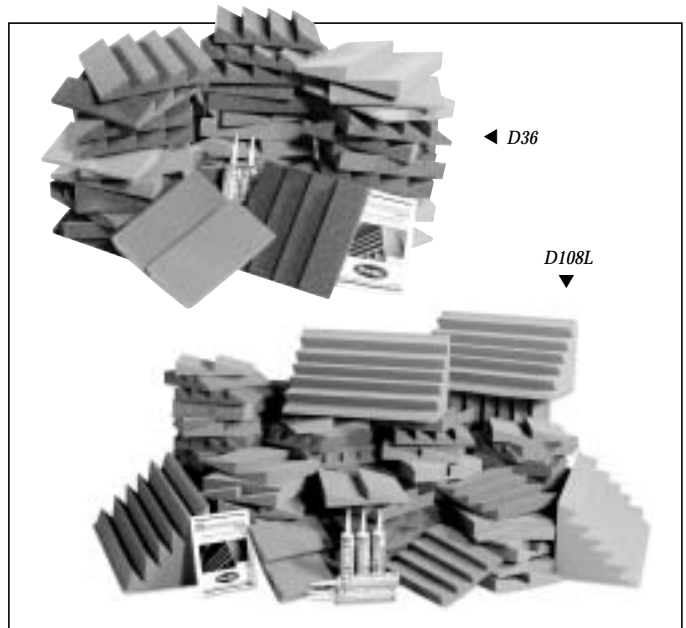

STUDIO ACCESSORIES

1389

AURALEX ACOUSTICS

CONSTRUCTION MATERIALS

STUDIO ACCESSORIES

1390

SheetBlok Sound Barrier

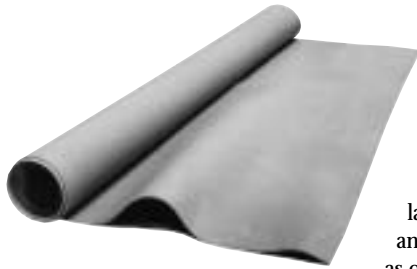

SheetBlok is a dense, limp-mass vinyl material that is about 6dB more effective than solid lead at stopping sound transmission. It acts as a thin, dense sound barrier layer in walls, ceilings or floors and is most effective when used as one component of a multi-

layered construction scheme. SheetBlok helps in decoupling (i.e. floating) floors and walls and, while not considered a finish product, is paintable with latex paint and can be the last layer in some cases. It can be used to wrap HVAC ducting, as a vent noise blocker, as a pipe noise insulator or under carpet/carpet pad. It holds up against harsh environments and cuts easily with a utility knife or scissors. SheetBlok can be doubled up, increasing its effectiveness from STC 27 to about 35.

SheetBlok 4' x 10' pieces (40 sq. ft.) Call
SheetBlok 4' x 30' rolls (120 sq. ft.) Call

Color: Black or Clear (subject to availability) **STC:** 27
Thickness: 1/8" **Weight:** ±1#/sq. ft. **Service Temperature:** -40° to 180° F
Tensile Strength: 400 psi **Tear Strength:** 70#/inch
Flammability: Rated UL94 S.E. "0"; Passes test MVSS-302
Notes: (1) STC stands for Sound Transmission Class, a rating of how effective a product is at being a sound barrier.

SheetBlok-Plus

Comes with pressure-sensitive adhesive already attached. Available in 4'x30' rolls only.

U-Boats

Floor Beam Float Channels

Made of a specially-formulated rubber compound, these U-shaped channels are used to support framing members and float (isolate and decouple) them from the surrounding structure. With the help of U-Boats, a floated room features greatly improved transmission loss (isolation) and low frequency definition. It's easy to figure how many U-Boats to get: simply multiply the total square footage of the area you want to float by two-thirds; the resulting number gives you the approximate amount of U-Boats you'll need.



U-Boats on 16" centers will alleviate 50-99% of vibrations above 40Hz. U-Boats on 32" centers will alleviate 50-99% of vibrations from 20Hz up.

Size: 2 1/8" x 1 1/2" x 2" (WHL) **Color:** Black
Thickness: 5/16" and 1/2" base
Quantity: Available in lots of 50 or more



Mineral Fiber Insulation



The best way to tighten up a room's sound and make it more soundproof, is to design it right, build it tight and make the partitions as dense as possible. That's where specialized Mineral Fiber comes in. It is very dense and is specifically designed for

acoustical usage. It's available in 2" and 4" thicknesses, and is designed to offer better bass trapping, overall absorption, thermal characteristics, moisture absorption and sound transmission loss (isolation) than any other product. For those of you in need of absorption, but for whom acoustic foam may not work for whatever reason (flame retardancy, looks, style, etc.), Mineral Fiber covered with specialized acoustical cloth is a viable alternative.

2" Mineral Fiber Insulation Call
4" Mineral Fiber Insulation Call
Quantity Per Box: 2" - 6 (48 sq. ft.); 4" - 3 (24 sq. ft.)
Flame Retardancy: Class A
Advantages vs. Standard Fiberglass: better sound isolation, better acoustic absorption, lower moisture absorption, better flame spread and smoke density, 1200° burn point vs. 650°

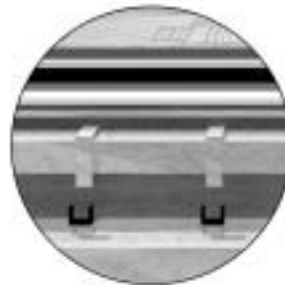

U-Boats, SheetBlok and Mineral Fiber help make the ideal floating floor

RC8 Resilient Channel

RC8 is a specially-formed, sturdy metal device that, when used to hang drywall (instead of just attaching the drywall to the studs or joists), greatly improves the sound transmission character-

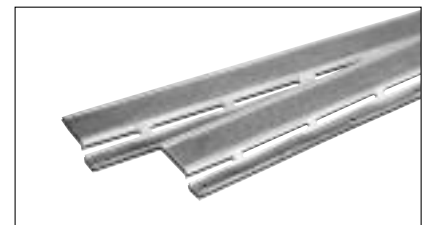

istics of the wall or ceiling system. RC8 should be installed horizontally at the bottom and top of your wall, then every 2' or less in between. Up to 2 layers of 5/8" drywall and a layer of SheetBlok may be hung on RC8, even on a ceiling. RC8 is available in handy 8' lengths that are ground shippable. There are twenty-four 8' pieces per tube.



For Any Inquiries Regarding Your Order, Call Our Customer Service:
(800) 221-5743 • (212) 239-7765 • FAX: (800) 947-2215 • (212) 239-7549

FURMAN

MS SERIES

Confidence Monitors

When your livelihood depends on the integrity of an electronic signal, an MS Series Confidence Monitor can give you blissful peace of mind. They provide assurance that analog audio, digital audio, or video signals are present and meet established quality standards before being broadcast, recorded, or otherwise distributed. The various models differ primarily in the types and number of signals they can monitor, though all are housed in compact, single space chassis that occupy minimal rack real estate. Monitoring is accomplished audibly (through speakers or headphones) and visually through meters and video monitors.



MS2ADV-1 ▲

▼ MS4AD-1

STUDIO ACCESSORIES

1391

FEATURES

They All Feature

- ◆ Each model features a pair of built-in highly compact yet full range shielded stereo speakers, along with a Speaker Mute switch.
- ◆ An amply powered TRS output is provided for headphone listening. Speakers and headphone amps share a volume slide control, and non-video models have Balance sliders.
- ◆ Phase indicator displays the phase relationship of the left and right channels of the monitored source. Indicator glows green to amber under normal conditions, and red (conditions of total phase reversal), helping determine mono-compatibility.
- ◆ Each input is routed to a bright, 14-segment LED meter, which may be switched for VU or PPM ballistics and +4 or +8 dBu reference levels with front panel switches.
- ◆ Meter brightness may be adjusted with a dimmer control, to suit user taste and variations in ambient lighting.
- ◆ All front panel control and indicator labels are rear printed on a heavy duty, wear-free mylar overlay.
- ◆ All analog inputs and outputs are high common-mode rejection XLR balanced, and each is provided with a rear panel signal activity indicator for easy identification of system problems. Outputs also have ±6 dB Gain Trim controls.

- ◆ They are powered with an included UL-approved external power supply via a DIN 5 connector. For maximum reliability, they feature a clean, modular design with minimal cabling. And all include a Three Year Limited Warranty

Analog/Digital Audio Models

- ◆ Models with digital monitoring capability are equipped with an A/D Select button and both front and rear bi-color digital signal activity indicator(s). Digital input(s) accommodate stereo digital signals sampled at up to 96 kHz, in AES/EBU format, via rear panel BNC inputs.
- ◆ A/D converters provide up to 8X oversampling, with a dynamic range of 95 dB.

Video Models

- ◆ Video models include a 1.8" LCD video monitor which automatically senses and displays either NTSC or PAL signals.
- ◆ Adjustments for color, brightness, contrast, and tint are provided on the front panel.
- ◆ Because the speakers in the MS Series are magnetically shielded, no special consideration is required for installation in critical locations near video monitors.

Six Models to fit any application

MS-2A-1: 2-channels analog audio inputs.....	739.95
MS-2AD-1: 2-channels analog and digital audio inputs.....	909.95
MS-4A-1: 4-channels analog audio inputs.....	839.95
MS-4AD-1: 4-channels analog and digital audio inputs	1050.00
MS-2AV-1: 2-channels analog audio inputs plus video inputs with LCD monitor	1294.95
MS-2ADV-1: 2-channels analog and digital audio plus video inputs with LCD monitor ...	1399.95



FURMAN

POWER CONDITIONERS

STUDIO ACCESSORIES

1392

PL-8 Power Conditioner and Light Module

Featuring triple-mode varistor spike and surge protection, the PL-8 is the perfect accessory to any equipment rack, providing the basic power protection essential to every audio or video system. Install a PL-8 in the top slot of your rack, and the eight switched

AC outlets on the rear panel will power up all your equipment while the two slide-out light fixtures provide discreet illumination of the controls for use on stages, in studios, or in any dark place. A dimmer control lets you adjust the lamp brightness to just the right level.

- ◆ Protects delicate electronic equipment by combining a high voltage surge and transient suppressor with an RFI/EMI interference filter. The fast-acting suppression circuit responds in nanoseconds, clamping spikes and surges to safe levels. The filter works to prevent electronic noise from fluorescent lights, electric motors and radio transmitters from leaking from the AC line into sensitive analog or digital circuits.
- ◆ The PL-8 can absorb a surge current of up to 6500 amperes for 10 ms without damage.
- ◆ Two slide-out, swiveling light fixtures for rack illumination.
- ◆ The lamps come supplied with 7 watt night-light bulbs. Bulbs are easily replaced without removing the unit from the rack. (Replacements are readily available and you can even use colored Christmas tree bulbs).
- ◆ Master switch controls the eight rear outlets and glows red when the power is on.
- ◆ A separate switch for the lamps allows you to check your equipment settings before applying power to it.
- ◆ Dimmer control for lamp brightness
- ◆ Rated at 15 amps, the front-panel circuit breaker can be easily and quickly reset should the PL-8 be overloaded.



PL-PLUS Ultra-Level Protection with Voltmeter and Lights



An enhanced version of the PL-8, the PL-PLUS offers improved surge protection, RF noise filtering and an AC voltmeter. The 20 LED bar-graph voltmeter reads from 90 to 128 volts in 2-volt steps. The normal range voltages are

indicated in green, with moderately and extremely high or low voltages in yellow and red respectively. The voltmeter's accuracy is ± 2 volts. It can easily be recalibrated if necessary. The sophisticated RFI filter network offers greatly improved capacity for stopping line noise. This filter incorporates a toroidal inductor and three high-voltage capacitors to achieve a common-mode noise attenuation of over 50 dB at 10 MHz. Finally, the PL-PLUS uses a longer power cable than the PL-8 (10' heavy-duty 14 gauge power cable).

PM-8 Power Conditioner with Current and Voltage Meters

The model to choose when rack lights aren't needed. The PM-8 has all the power conditioning features of the PL-PLUS, plus it has a ninth unswitched outlet whose front panel location makes it very convenient for

equipment in temporary use. It has both a voltmeter and an ammeter. The ammeter reads true RMS current, so it will indicate reliably and meaningfully for all loads, including inductive and capacitive loads such as power amplifiers. (Ammeters that respond only to average AC current may give readings that differ widely from RMS-reading meters.) The PM-8's voltmeter reads from 90 to 135 volts in 5 volt steps. The ammeter reads from 0 to 20 amps, in 2 amp steps.



For Any Inquiries Regarding Your Order, Call Our Customer Service:
(800) 221-5743 • (212) 239-7765 • FAX: (800) 947-2215 • (212) 239-7549

FURMAN

POWER CONDITIONERS

Metered Six Series

The Metered Six are an extension of Furman's well-respected 15- and 20-Amp power conditioners. The "Metered Six" differ from their siblings by the inclusion of additional filtering for digital equipment, Digital AC voltmeter, and all (except the PL-PLUSD and PL-PROD) feature a Digital AC current meter. The current meter is a true R.M.S. variety, and both meters sport laboratory accuracy. The true R.M.S. (root mean squared) current meter, allows installers to read the total system current draw without the false readings typically experienced due to distorted AC voltages. Additionally, digital AC outlets provide increased filtering and inhibit contamination of neighboring components.



STUDIO ACCESSORIES

1393

FEATURES

- ◆ All units are single 19" rack space, and feature an attractive black anodized front panel, and rust proof chromate steel chassis for positive ground contact. They can withstand a one-time power surge of 6500 amps (11,000 amps for Pro models).
- ◆ Common and transverse mode noise is greatly diminished through Furman's three stage RFI/EMI filtering. This prevents fluorescent lights, radio transmitters, and similar sources of "electrical pollution" from leaking into sensitive audio/video components.
- ◆ Each unit features (4) digital and (4) analog AC outlets, which are activated by either a red backlit power switch, or a blue handled magnetic circuit breaker (Pro Series).
- ◆ An independent power switch activates units featuring dual retractable lights. This allows you to carefully inspect an entire equipment rack's settings prior to turn-on.
- ◆ All power switches have been chosen to handle high in-rush peaks, typical in many high performance power amplifiers.
- ◆ Each features a 10' heavy-duty power cord and full safety compliance for North America through C-UL listing.
- ◆ Metered Six units featuring dual retractable lights come supplied with one 7-watt night-light bulb per light tube. Replacements are available in 4 to 7-watt sizes at most super-markets and hardware stores.

PRO Models (Only)

- ◆ 20 Amp (2400 Watt) rating handles even the largest amps
- ◆ The three PRO units add an "extreme voltage shut-down" circuit. Useful in installations where faulty wiring and accidental 220v AC feeds are common, this circuit senses AC voltages that are either so high or low that operation would be impossible (under 80v AC or over 140v AC). The circuit then immediately shuts down all output power well before damage can occur.
- ◆ Additionally, "Protection OK" and "Ground OK" monitor the integrity of the wiring and protection devices.

Metered Six Models

PL-PLUSD: 15 Amp, dual retractable rack lights, digital volt meter	174.95
PL-PLUSDM: 15 Amp, dual retractable rack lights, digital volt/current meter	189.95
PM-8DM: 15 Amp, digital volt/current meter	174.95
PL-PROD: 20 Amp, dual retractable rack lights, digital volt meter	299.95
PL-PRODM: 20 Amp, dual retractable rack lights, digital volt/current meter	308.95
PM-PRODM: 20 Amp, digital volt/current meter	289.95

PL-PRO and PM-PRO



Non-Digital 20-Amp Power Conditioners

The predecessors to the Metered Six series, the industry-standard PL-PRO and PM-PRO are almost identical to their respective digital counterparts (PL-PROD and PM-PRODM), except they use LED readouts instead of digital readouts, and they don't include the special outlets with filtering for digital equipment. Like the PL-PROD and PM-PRODM, they feature 20 AMP operation, Extreme Voltage Shutdown, critical functions are monitored by a "smart" microprocessor, and LED status indicators report on problems.

FURMAN

POWER CONDITIONERS/SEQUENCERS

STUDIO ACCESSORIES

1394

PS-8/PS-8R Ultra-Level Protection with Sequencing

The PS-8 Power Sequencer is needed whenever various kinds of equipment must be powered up or down in groups, rather than all simultaneously. In audio systems, sequenced powering is often necessary to



allow turn-on transients from low level amplifiers and processors to settle down before any power amps are turned on, because simultaneous powering would result in a loud, annoying, and potentially destructive "pop" reaching the speakers. And in any large system whose components present an inductive load to the AC line (including electric motors, power supplies, and power amplifiers of all kinds), sequenced powering can avoid excessive inrush currents that cause circuit breakers to trip even though the steady-state currents are not excessive. The PS-8R is identical to the PS-8 except it can be remotely switched on/off from a distance.

- ◆ Using them is a simple and inexpensive way to apply and remove power in a controlled, repeatable, foolproof 3-step sequence. Ideal when large installations must be switched on or off by inexperienced personnel.
- ◆ There are three outlet pairs labeled Delay 1, Delay 2, and Delay 3, that receive power almost immediately, 5 and 10 seconds respectively after the power switch is turned on. When power is turned off, the sequence is reversed (Delay 3 loses power almost immediately, Delay 2 1 after 5 and 10 seconds. Intervals are preset but can be changed via internal trimpot adjustment.
- ◆ In addition to the delayed outlets, a single front panel outlet and a rear panel pair are unswitched.
- ◆ They offer all basic power conditioning features including 15 Amp operation, varistor spike and surge protection across all three modes, as well as a sophisticated EMI/RFI filter for blocking radio frequency line noise. Clean, filtered power is provided at all 9 outlets, even the unswitched ones.
- ◆ They can detects faults in AC wiring. Green and and red neon indicators light in a specific pattern for normal wiring and in different patterns for various faults.
- ◆ If a fault is present, a chart next to the indicators will identify its exact nature.

PS-8R Step-up Feature

The PS-8R is identical to the PS-8 with the addition of a barrier terminal strip on the rear panel that allows a switch (either a momentary or maintained-contact type) to be connected to turn the unit on and off at a distance. If a 3-conductor cable is used, an LED may also be installed at the remote end to indicate that the power is on. The Delay 1 LED on the PS-8R blinks to indicate the remote switch is off.

PS-8.....212.50 PS-8R244.95

PS-PRO Pro-Level Protection with Sequencing and Remote



The PS-PRO Power Conditioner/Sequencer is capable of powering up a rack full of equipment in a 3-step delayed sequence. The sequence is reversed for power-down. The sequence can be initiated with either

momentary or maintained switches, locally or remotely. A duplex outlet is provided for each delay step. A front panel screwdriver adjustment sets the delay time. A locking switch with a removable key is provided for maximum security. The PS-PRO also contains special circuitry to detect additional wiring faults such as reversed hot and neutral, missing ground or neutral, etc. One or more PS-PROs may be installed in remote locations and operated via low-voltage wiring.

PS-PRO Step-up Features:

- ◆ 20 Amp (2400 Watt) rating
- ◆ Multiple levels of protection components can safely absorb large spikes and provide highly effective RF filtering — the most comprehensive protection available.
- ◆ Extreme Voltage Shutdown guards against destructive wiring faults
- ◆ Critical functions are monitored by a "smart" microprocessor; LED status indicators report on problems
- ◆ Locking switch with a removable key is provided for maximum security.
- ◆ Heavy duty 10 foot, 12 gauge line cord

PS-PRO.....462.95



EQUIPMENT LEASING AVAILABLE

FURMAN

AR-1215/1220/1230/PRO

Voltage Regulators

Furman's AR series are voltage regulators designed to protect audio, video, computer and other electronic equipment from problems caused by AC line voltage irregularities—sags, brownouts, or overvoltages that can cause sensitive digital equipment to malfunction, or, in extreme cases, to sustain damage.

They provide a steady, stable 120v AC output. The 15 amp AR-1215, 20-amp AR-1220 and 30-amp AR-1230 accept any voltage from 97v to 141v and transform it to a constant 120V, $\pm 5V$. (Voltages beyond that range may also be converted to usable levels, depending on how far out of range they are).

The AR Series has been designed specifically with the unique needs of audio and video in mind. Its technology differs from that of computer-oriented voltage regulators in many important ways. For example they don't use a ferro-resonant transformer, which would be heavy and bulky, radiate a large magnetic field, and be too frequency-sensitive to be usable with generators. Instead, they use a design based on an eight-tap toroidal autoformer. The toroidal design assures minimal leakage of stray magnetic fields.

STUDIO ACCESSORIES

1395

FEATURES

- ◆ Their circuitry monitors the incoming line voltage with each cycle, comparing it to an extremely precise voltage reference, accurate to $\pm 0.15\%$. If a voltage fluctuation requires that a different tap be selected, the new tap is electronically switched exactly at the zero-crossing, to avoid distorting the AC waveform. (Some commercial voltage regulators using multiple-tapped transformers switch taps at uncontrolled times, thereby creating voltage spikes, often creating clicks that can leak into the audio.) Since the AR Series design is not sensitive to small errors in line frequency, they are ideal for using with e with generators.
- ◆ They offer power conditioning that is truly in class by itself, thanks to the quantity, quality and configuration of the over-voltage suppression devices used. These include MOV's and high voltage inductors and capacitors. This unique combination can safely divert large spikes as well as filter audible high frequency noise.
- ◆ For added safety and protection, the Extreme Voltage Shutdown function senses dangerously high or low voltages and shuts down the output before any damage is done. The output remains off until the overvoltage or undervoltage is removed, with an LED indicating the shutdown condition. This invaluable feature protects your equipment from accidental connection to incorrect line voltages (for example, 220v when 120v is expected).

AR-1215

The AR-1215 has eight 15 Amp outlets on the rear panel, and



one on the front panel. All outlets are regulated, spike-suppressed, and filtered against RFI with a 3-pole filter. There are no controls except the circuit breaker/on-off switch. A bar-graph meter comprised of 10 LED's indicates input voltage, while another LED indicates "In Regulation" status (i.e., that the output voltage is within $\pm 5V$ of 120V.) Housed in a compact, single-space rack-mount chassis, 1.75" high and 8" deep and weighs only 12 lbs.....**459.95**

AR-1220 Step-up Features



The AR-1220 has twelve 20 Amp outlets on the rear panel, and two 15 Amps on the front panel.

Housed in a two-space rack-mount chassis, 3.5" high and 17" deep, weighs 35 lbs.....**929.95**

AR-1230 and AR-PRO Step-up Features

The AR-1230 has one 30A, NEMA L14-30P twistlock inlet, one 30A NEMA L14-30R twistlock outlet, and six Edison outlets on the rear panel,



plus two Edison outlets on the front panel. Housed in a compact, two-space rackmount chassis, 3.5" high and 17" deep, 39 lbs. Similarly, the 30 Amp AR-PRO delivers 120v AC $\pm 4\%$ anywhere in the world within ranges of 88 to 134 and 170 to 264v AC, 50/60 Hz. It has an input voltmeter bar-graph and output ammeter bar-graph with 21 LEDs. Monitor indicates low, normal, or high output voltage. 14 regulated, 20A conditioned outlets (2 front, 12 rear). It has a provision for remote turn-on/off; multiple units may be turned on simultaneously or in a delayed sequence. Weighs 50 lbs.

AR-1230**1399.95** AR-PRO.....**1799.95**

ORDER & INFO. (212) 444-5088 • FAX: (212) 239-7770 (800) 947-7008
1-800-875-6951 • www.bhphotovideo.com



FURMAN

IT-1220/IT-1230

STUDIO ACCESSORIES

1396

Balanced Power

Designed for the most critical, ultra-low-noise installations, the IT-1220 and IT-1230 supply 20 or 30 amps of balanced AC power to recording studios, video or film production facilities, broadcast stations, etc. They drastically reduce hum and buzz caused both by ground currents from power supply filtering and by radiation from supply cables into sensitive lines, particularly low level and unbalanced sources. (They have also been reported to noticeably improve dynamic range and sonic clarity. At the heart of these units is a specially wound and shielded toroidal isolation transformer with a center-tapped secondary. These precision transformers, in conjunction with wideband EMI/RFI filters and output spike protection, make these units excellent power conditioning solutions for any situation.



- ◆ The IT 1220 rear panels provide 12 outlets, the front panel provides two. The IT-1230 rear provides ten 20A outlets, one 30A twistlock outlet and one 30-amp twistlock inlet. The front provides two 15A outlets. All outlets are balanced and Ground Fault Circuit Interrupter protected.
- ◆ An IT-1220 can be installed in minutes without an electrician, the IT-1230 however, may require an electrician.
- ◆ Exclusive "Soft Start" circuit prevents the large inrush surge currents and spikes that would otherwise occur at turn-on and turn-off with such large transformers.
- ◆ Accurate, self-checking AC voltmeter measures not only normal voltages, but also flashes eye-catching special pattern alerts for off-scale but not extreme conditions (80-90 or 130-140 volts).
- ◆ They provide clean and completely safe power – there is no need to "lift grounds" or compromise the integrity of safety ground wires to achieve hum reduction.
- ◆ Extreme Voltage Shutdown circuit shuts-down the unit if exposed to dangerous voltages (like accidental connection to 220v)
- ◆ The IT-1220 and IT-1230 occupy three rack spaces (5.25" high).

IT-12201099.95 IT-1230.....1299.95

IT-REFERENCE

Discrete Symmetrical AC Power Source



The ultimate expression in AC power filtering, the IT-Reference provides transparent, ultra-low noise AC power for the most discriminating audio/video professional.

Same features as the IT-1220 plus:

- ◆ Discrete 5A windings for each set of outlets. This is critical, as modern video and digital components can couple performance-degrading noise into each other, even if the filtering from the source AC is the best money can buy.
- ◆ Exclusive power correction circuitry gives all power amplifiers the ability to reproduce dynamics with extreme power, speed, and clarity that will produce startling three-dimensional images.
- ◆ 20 Amp peak power, 12 Amp continuous power
- ◆ 4 high current ultra low impedance outlets for power amplifiers and powered monitors
- ◆ 4 pairs of individually isolated, electrostatically shielded, positive contact AC outlets designed for analog and digital audio and video components



www.bhphotovideo.com

FURMAN

SRM-80A

Signal Router/Monitor

The SRM-80A provides all of the flexibility and capabilities of large format console "Monitor Section" in an easy to use 1U device. Designed to simplify mixdown and dubbing from the single stereo output from DAWs, associated computer sound cards and digital I/Os, the SRM-80A provides signal routing and monitoring for four stereo mixdown devices such as DAT machines, cassette decks, CD burners, MiniDisc recorders, as well as three sets of studio monitors and/or headphone amps. The SRM-80A also simplifies mixdown and copying between different media types. Multiple copies can all be made simultaneously between DATs, CD Burners and other devices, through use of the SRM-80A's "Source Select" switches.

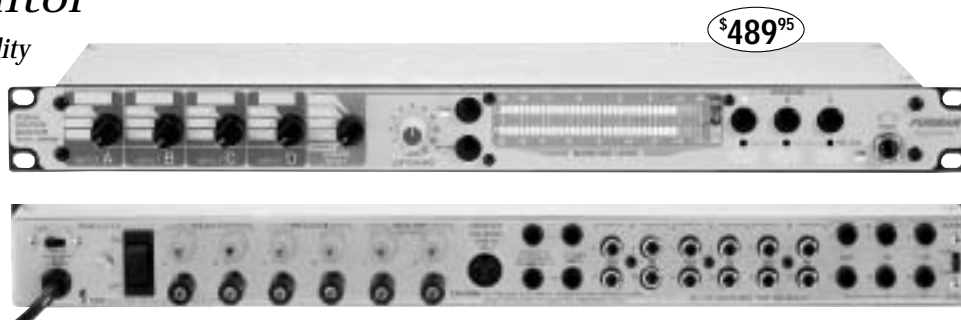

- ◆ Use one power amp to drive two speaker pairs, also accommodates one pair of self-powered speakers.
- ◆ Monitor using three different speaker pairs, at the same loudness, using exclusive "set-once" level trims.
- ◆ Speaker button "A" switches line-level for driving self-powered monitors; B and C use a high power relay to redirect your power amp output to either of the two pairs.
- ◆ Gain adjust for each speaker pair allows for equal loudness when switching between them.
- ◆ High power headphone amp for private monitoring and mix checking.
- ◆ 40-segment high resolution metering for L/R monitor outputs
- ◆ VU meter display with peak hold function
- ◆ Peak or Average response switch
- ◆ Line level can be set to -10 or +4 dBu
- ◆ Ground lift switch
- ◆ DIM button reduces level by 15 dB during interruptions —an easy way to lower the listening level temporarily without having to adjust the listening level control
- ◆ Mono Sum let you check for radio compatibility, stereo imaging, and phase problems
- ◆ Optional remote allows five push button functions (MONO, DIM, and SPEAKER SELECT) to be at the listening location.

STUDIO ACCESSORIES

1397

PGP-20/PGP-60

PlugLock PRO 20 and PlugLock PRO 60 Locking Outlet Systems

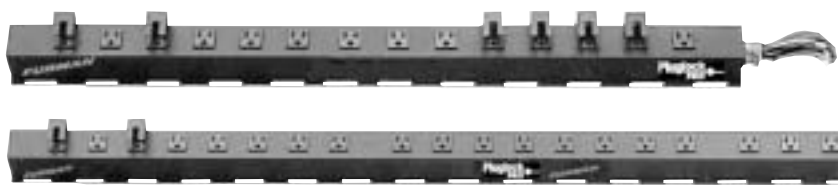

The PlugLock PRO 20 and PRO60 are locking outlet systems that provide unprecedented ease, versatility and reliability for professional rack applications. Both

feature rugged, all-metal construction, and include a set of Furman's metal PlugLock clamps that securely lock any plug or wall wart into place for reliable operation. The PGP-60 comes with 12 clamps, the PGP-20 comes with 8 clamps.

Rated at 40 amps, the PGP-20 provides 14 Edison outlets (10 on one circuit, four on the other) in a chassis that is only 30" tall and can be mounted vertically in smaller racks and other locations.

The PGP-60 provides 24 Edison outlets in its 60" tall chassis, and is designed primarily for vertical mounting in equipment racks. The PGP-60 is rated at 60 amps, divided into three 20 amp circuits to provide flexibility for multiple and varying applications. The included 3/4" nipple mount allows an electrical junction box to be mounted either at the top or bottom of the PGP-60. Power sequencing relays are also available. A local circuit breaker can be easily added to each of the 20 amp circuits if necessary.

PGP-20.....88.50 PGP-60.....177.50

MIDDLE ATLANTIC

EDIT CENTER SERIES

Multimedia Studio Furniture

An elegant, ergonomic workspace for the professional

- ◆ Suitable for any production or editing environment including project studios, post production editing suites, learning labs, and broadcast facilities
- ◆ Factory-assembled systems are available in either a graphite or cherrywood laminate finish
- ◆ Essential features that professionals require are built-in — no need to purchase expensive options
- ◆ Desk systems are available in two sizes: 84" and 60" wide
- ◆ Overbridges are capable of accommodating multiple 21" computer monitors as well as large program monitors
- ◆ Two pivoting speaker platforms (standard on all Edit Center overbridges) allow you to place your audio monitors at the optimum listening angle
- ◆ Two overbridge styles are available to optimize your system: one features two 4-space rack bays angled for direct viewing, while the other features an open span underneath



Edit Center with Side Racks — are available with either single or dual 12 space racks, with or without doors. Racks with factory-installed gasketed doors (plexi front and solid rear) along with internal acoustical absorptive material reduce noise escaping from the enclosure by up to 22db. The rear doors features an ultra low-noise cooling fan, a removable filter kit for air intake, and a brush grommet at the door bottom that allows cable exit while maintaining a seal for noise and air flow.

STUDIO ACCESSORIES

1398

DIMENSIONS

desks shown with monitor platforms at minimum and maximum extensions

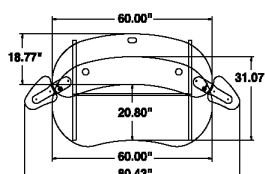

ES top view

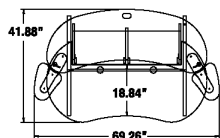

ESUR top view

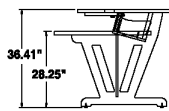

side view (all desks)

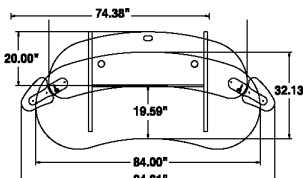

EL top view

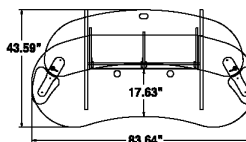

ELUR top view

DESKS

- ESC: 60" cherry desk with overbridge**1460.00**
- ESURC: 60" cherry desk with overbridge with (2) 4 space rackbays ...**1570.00**
- ELC: 84" cherry desk with overbridge.....**1540.00**
- ELURC: 84" cherry desk with overbridge with (2) 4 space rackbays.....**1640.00**
- EDSC: 60" cherry producer/client desk, no overbridge**980.00**
- EDLC: 84" cherry producer/client desk, no overbridge**1180.00**

Also available in graphite color.

DESKS WITH SIDE BAY RACKS

- ES+S12D: 60" desk with overbridge and 1 single bay outboard rack (with front/rear doors, cooling kit).....**2450.00**
- ESUR+S12D: 60" desk with overbridge, two 4 space rackbays and 1 single bay outboard rack**2600.00**
- ELUR+S12D: 84" desk with overbridge, two 4 space rackbays and 1 single bay outboard rack**2700.00**
- ELUR+D12D: 84" desk with overbridge, two 4 space rackbays and 1 dual bay outboard rack.....**3070.00**

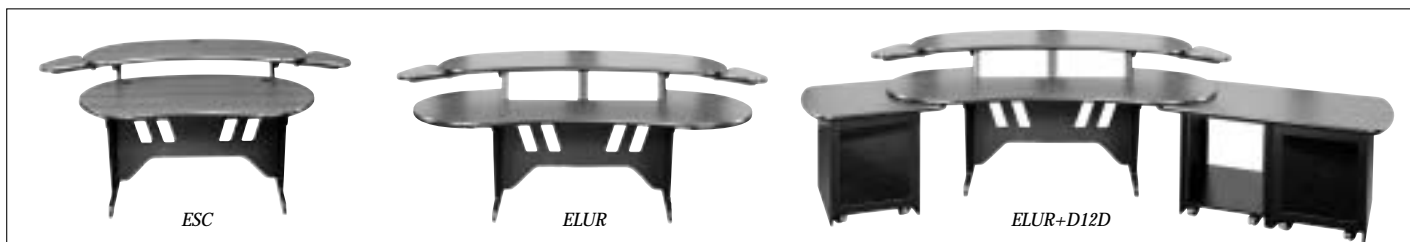

ONE HOUR FREE PARKING

AT 349 W. 34th STREET (with purchase of \$100 or more)

MIDDLE ATLANTIC

EDIT CENTER SERIES

Side Bay Racks with Doors, Noise Control and Cooling System

Standard on all Edit System Series Workstations

- ◆ Available in single or dual bay configuration, with either a graphite or cherry wood laminate top, complete with casters
- ◆ Contoured reversible top matches the desktop, allowing the racks to be positioned at a comfortable angle to the user
- ◆ Racks can join the desk flush, or slide under the desk top
- ◆ Front rackrail is set-back 2" for equipment clearance; rear rackrail can be positioned at any of four pre-drilled depths
- ◆ An optional laminate shelf can be mounted in place of rackrail
- ◆ Gasketed plexiglass front doors and gasketed laminated rear doors control noise and open 95° on concealed hinges
- ◆ Rear door features a built-in ultra low-noise fan, a removable filter kit, and a brush grommet at the door bottom that allows cable exit while maintaining a seal for noise and air flow
- ◆ Single racks come standard with front and rear door; dual racks include doors on one bay only. Racks can be ordered without doors
- ◆ 11-gauge, 10-32 threaded front and rear rackrail are set back 2" for equipment clearance
- ◆ All Edit Center racks ship fully assembled

D12D: 12 space dual bay outboard rack, weighs 262 lbs.....**1570.00**

S12D: 12 space single bay outboard rack, weighs 152 lbs**1150.00**

SQUARE-TOP ISOLATION RACKS

Available in 12 and 24 space, these racks are available with a graphite finish top to match graphite Edit Center desks.

S12SDG: 12 space single bay rack; square graphite top, 150 lbs.....**1120.00**

S24DG: 24 space single bay rack; square graphite top, 206 lbs.....**1320.00**

SIDE BAY RACKS WITHOUT DOORS, NOISE CONTROL OR COOLING SYSTEM

Available in graphite or cherry wood laminate top, complete with casters.

S12: Single bay outboard rack (12 rackspaces), 134 lbs.....**695.00**

D12: Dual bay outboard rack (12 rackspaces), 242 lbs**1240.00**

DESKTOP RACK

Provides an extra 8 rackspaces of desktop equipment mounting. Includes graphite top and factory installed 11-gauge, 10-32 threaded front rackrail.

DT8G: Table top rack (8 rackspace); weighs 41.3 lbs.....**250.00**



STUDIO ACCESSORIES

1399

Producer/Client Desks

Introducing an elegant producer/client desk that perfectly matches the existing Edit Center desks and complements any studio environment. Both the 60" EDS and 84" EDL models feature the new X-Brace leg system, which provides extreme stability and allows these desks to be used independently with full-circumference seating capability. EDS and EDL desks are available in an attractive marbled graphite or cherry, and can be used with Edit Center side-bay racks.



MIDDLE ATLANTIC

MULTIDESK VIDEO

STUDIO ACCESSORIES

1400

Modular Studio Furniture System

- ◆ Well suited for project or professional studios
- ◆ Modular design allows components to be used together in any combination — you configure a complete system that accommodates the way you work based on your specific requirements
- ◆ There are four desk models to choose from, each finished in high-pressure graphite laminate with sturdy steel tube legs and overbridges that can accommodate audio or video monitors
- ◆ Optional accessories include a 12RU side rack with matching optional overbridge, as well as a connecting wedge for angling a rack

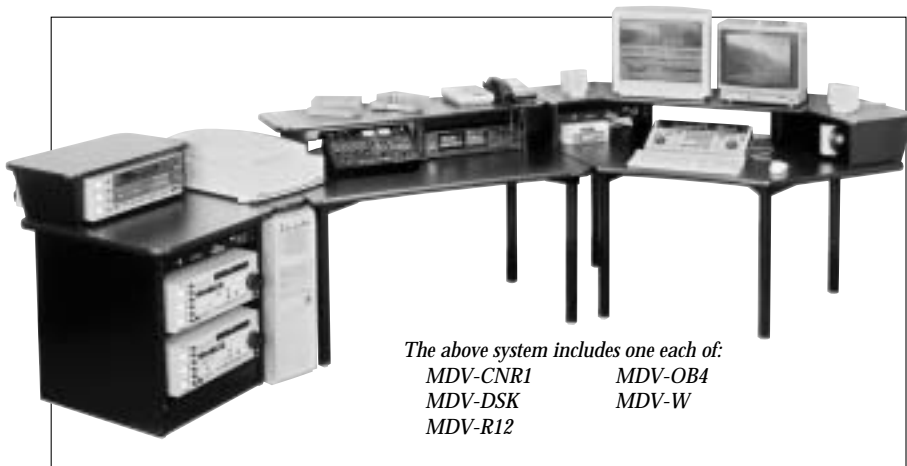

The above system includes one each of:
 MDV-CNR1 MDV-OB4
 MDV-DSK MDV-W
 MDV-R12

MDV-DL Desk

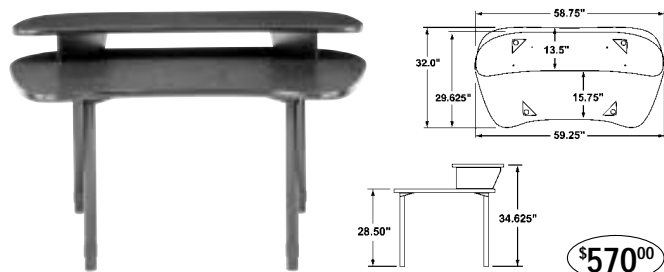

- ◆ 59" wide footprint provides lots of workspace
- ◆ Overbridge accommodates multiple monitors and is set 6" above the desktop — the correct height for ergonomic viewing
- ◆ Standard 28.5" desktop height
- ◆ Can be used with either the Edit Center line of isolation racks or an MDV-R12

MDV-CNR3 Corner Desk

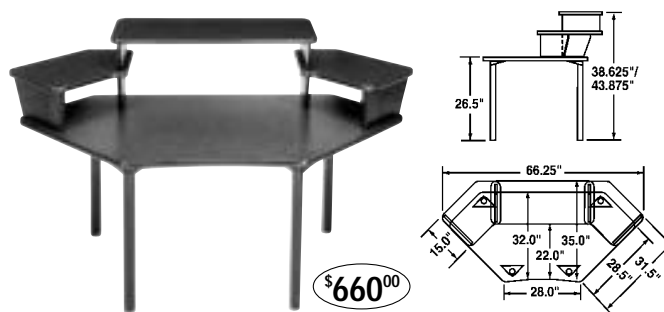

- ◆ 3-piece overbridge accommodates mixers with tall meter bridges
- ◆ The overbridge center section can be adjusted to 11 1/4" inside height clearance, or 16 1/2" inside height clearance
- ◆ Center section provides 30" inside width clearance
- ◆ 28.5" desktop height

MDV-CNR1 Corner Desk

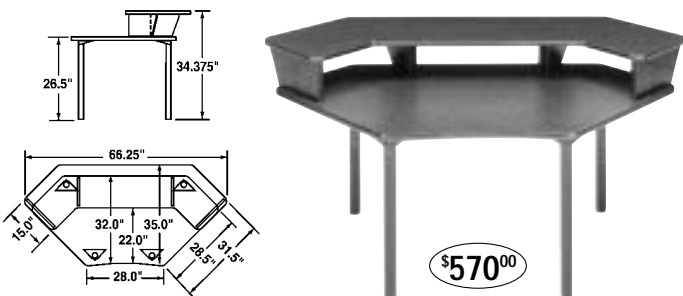

- ◆ A one-piece overbridge is user-configurable three ways: one 4 space rackbay in center, two 4 space rackbays on sides, or middle supports justified to outside to accommodate mixers up to 32"
- ◆ Overbridge provides 7" inside height clearance
- ◆ 28.5" desktop height

MDV-DSK Straight Desk

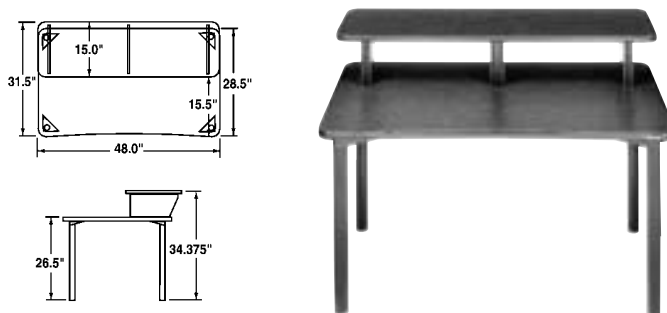

- ◆ Overbridge can be user-configured as two 4 space rackbays, or remove center section to accommodate mixers up to 39" wide
- ◆ Overbridge provides 7" inside height clearance
- ◆ 28.5" desktop height



For Any Inquiries Regarding Your Order, Call Our Customer Service:
 (800) 221-5743 • (212) 239-7765 • FAX: (800) 947-2215 • (212) 239-7549

MIDDLE ATLANTIC

MULTIDESK VIDEO

MULTIDESK ACCESSORIES



\$220⁰⁰

MDV-R12 Side Rack

- ◆ Add to any MDV desk for additional rackmount capacity and desktop space
- ◆ 12 rackspace
- ◆ Accepts optional casters
- ◆ 26.5 x 23 x 28.5" (HxWxD)

MDV-OB4 Overbridge

- ◆ Mounts on top of the MDV-R12 rack
- ◆ Provides additional 4 rackspace
- ◆ When placed beside any MDV desk, a contiguous surface is maintained
- ◆ 7.875 x 23 x 15" (HxWxD)



\$125⁰⁰

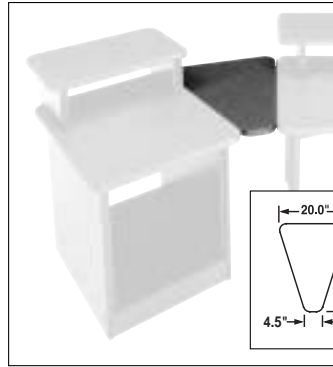

MDV-W Connecting Wedge

- ◆ Connect any MDV component at an ergonomic 35° angle
- ◆ Mounting hardware is included

\$95⁰⁰

MDV-CK Caster Kit

- ◆ Includes four wheels, two metal caster saddles and mounting hardware. Fits MDV-R12 racks72.00



SPEAKER STANDS

Although designed as an accessory for the Edit Center system, these elegant speaker stands can easily integrate into any production environment including the multiDesk Video System.

- ◆ 36" high speaker stands that are optimized to accommodate near and mid-field audio monitors in video and audio production and editing facilities
- ◆ High-mass all wood construction for resonance damping
- ◆ Includes carpet spikes and rubber feet to accommodate all floor surfaces
- ◆ Unique dual cable channels separate audio and AC cables (when using powered monitors), and include a wide molded cover
- ◆ 15 1/4" x 15 3/4" platforms and bases are reversible to show either a graphite or cherry wood laminate surface
- ◆ Elegant curved supports are finished in a durable black texture-lac



EC-SPK36300.00 a pair

Cable Management Kits

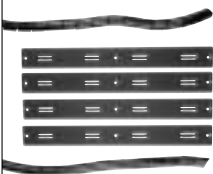

These convenient cable management kits effectively organize the mass of cable typically found in digital video and audio systems. Kit consists of spiral wrap to contain cables, and flat panels with tie-points to manage cable under-desktops.

CM-L: Cable management kit for 84" desk system, includes 8 cable managers and 20' cable wrap70.00

CM-S: Cable management kit for 60" desk system, includes 4 cable managers and 20' cable wrap60.00

MIDDLE ATLANTIC

STUDIO RACKS

STUDIO ACCESSORIES

1402



OAK EQUIPMENT RACKS

OBRK Series 18" Deep Racks

- ◆ Attractive 3/4" oak laminate racks blends natural elegance with value-oriented engineering
- ◆ Assembles easily with the included concealed 1/4-turn fasteners and threaded inserts
- ◆ Factory-installed 11-gauge, 10-32 threaded rackrail
- ◆ Available in 8, 12, 16 and 20 rack spaces

OSR Series Sloped Racks

- ◆ The same construction as the OBRK series with a gently sloped rackface that facilitates easy equipment viewing
- ◆ Included casters enhance mobility
- ◆ Available with 16 and 24 rack spaces

OBR SERIES

Part #	Racking Height	Depth	Overall Height	Price
OBRK8	14" (8 Space)	18"	15½"	135.00
OBRK12	21" (12 Space)	18"	22½"	145.00
OBRK16	28" (16 Space)	18"	29½"	170.00
OBRK20*	35" (20 Space)	18"	36½"	185.00

OSR SERIES

Part #	Racking Height	Depth (Top - Bottom)	Overall Height	Price
OSR16	28" (16 Space)	19½" - 23"	36½"	240.00
OSR24**	42" (24 Space)	19½" - 23"	50½"	275.00

*Accommodates short vertical power strip. ** Accommodates medium and short vertical power strip. To install power strip, quick clips must be screwed to sides, or PB-5A used on optional rear rackrail.)

BLACK LAMINATE EQUIPMENT RACKS

RK Series (16" Deep) and BRK Series (18" Deep) Equipment Racks

- ◆ Constructed with 5/8" furniture-grade MDF board
- ◆ High-quality black laminate finish
- ◆ Easily assembled with included tool and hardware
- ◆ 16" deep (RK Series), or 18" deep (BRK Series)
- ◆ Optional caster kit available (RKW)

Part #	Racking Height	Depth	Overall Height	Price
RK2	3½" (2 Space)	16"	5"	85.00
RK4	7" (4 Space)	16"	8½"	92.00
RK8	14" (8 Space)	16"	15½"	108.00
RK12	21" (12 Space)	16"	22½"	115.00
RK16	28" (16 Space)	16"	29½"	125.00
RK20*	35" (20 Space)	16"	36½"	130.00
BRK8	14" (8 Space)	18"	15½"	115.00
BRK12	21" (12 Space)	18"	22½"	125.00
BRK16	28" (16 Space)	18"	29½"	130.00
BRK20*	35" (20 Space)	18"	36½"	145.00

RKW Wheel kit-2 locking (adds 2¼" to height)40.00

*Accommodates short vertical power strip. To install, quick clips must be screwed to sides, or PB-5A used on optional rear rackrail.)

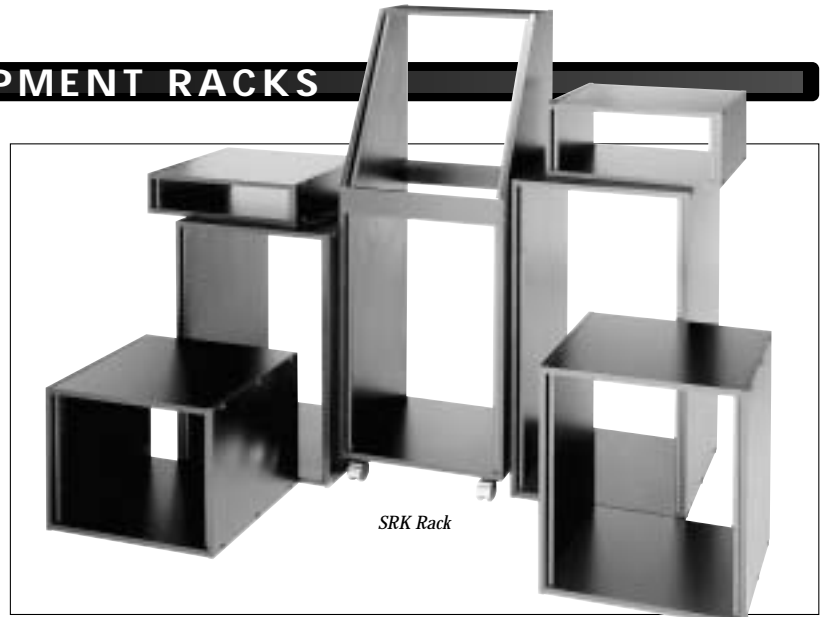

SRK Rolling Equipment Rack

- ◆ 16 vertical rackspace at bottom; 12 sloped rackspace on top
- ◆ 54¼" high x 16" deep at bottom
- ◆ Black laminate finish
- ◆ Easily assembled with included hardware
- ◆ Factory-installed casters included

SRK racks accommodate medium and short vertical power strip. To install, quick clips must be screwed to sides, or PB-5A used on optional rear rackrail.)



EQUIPMENT LEASING AVAILABLE

MIDDLE ATLANTIC

STUDIO RACKS

STUDIO ACCESSORIES

1403

Slim 2 Series Desktop Turret Racks

Fully Assembled Steel Frame with Laminate Sides

- ◆ Ships fully assembled
- ◆ Incorporates a sturdy black steel open frame and removable black laminate side panels
- ◆ Sloping rack face for easy equipment viewing
- ◆ Frames can easily be joined with the open sides and bottom allowing wire passage
- ◆ Front and rear 11-gauge, 10-32 threaded rack rail is standard

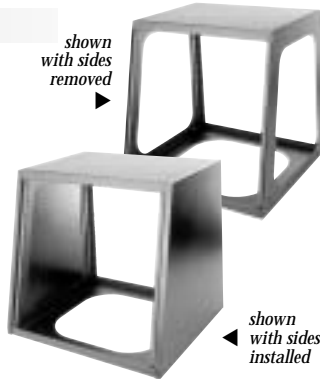

Part #	Racking Height	Top Depth	Bottom Depth	Overall Height	Price
2-10	17 1/2" (10 space)	14.1"	18"	19 1/2"	230.00



KD Black Laminate

- ◆ Ships flat and assembles effortlessly with provided hardware
- ◆ Constructed from high pressure black melamine
- ◆ Sloping rack face offers easy equipment viewing

- ◆ Front and rear 10-32 threaded rack rail is standard

Part #	Racking Height	Top Depth	Bottom Depth	Overall Height	Price
2-10M	17 1/2" (10 space)	14.7"	17.9"	19 1/2"	175.00
2-6M	10 1/2" (6 space)	15.9"	17.9"	12 1/2"	155.00

OBR/BRK/RK Series Front Doors

Racking Height	Solid Steel	Plexiglass	Vented Steel
14" (8 space)	SSDR-8 80.00	PSDR-8 130.00	VSDR-8 100.00
21" (12 space)	SSDR-12 82.00	PSDR-12 150.00	VSDR-12 120.00
28" (16 space)	SSDR-16 86.00	PSDR-16 165.00	VSDR-16 135.00
35" (20 space)	SSDR-20 100.00	PSDR-20 200.00	VSDR-20 150.00



- ◆ Security doors for the OBRK, RK, and BRK series racks
- ◆ Protects equipment from tampering
- ◆ Standard keylocks, black powder coat finish
- ◆ Available in solid steel, plexiglass, and vented steel models

Desktop Rail Racks

Lets you quickly and inexpensively organize desktop processing and test equipment. Offered in 8 and 12 space sizes, both models extend upward at a gentle slope. Overall width is 19", depth is 11 1/2".



Part #	Racking Height	Overall Height	Price
DR-8	14" (8 space)	15 1/2"	46.00
DR-12	21" (12 space)	22 1/2"	50.00

Computer Enclosures

RM-CPU-ATX Rackmount Computer Chassis

- ◆ Vibration-isolated bay with a lockable, latched front door
- ◆ Rackmounts ATX motherboards
- ◆ Accommodates up to 5 drives (three 5 1/4" and two 3 1/2" drives)
- ◆ Includes 2 cooling fans + washable filter
- ◆ 300 watt ATX Pentium 4 compliant power supply
- ◆ 7" (4 space) height
- ◆ Accepts any motherboard up to 12 x 9"



SL-18 Computer Chassis Slide Kit

- ◆ Allows you to slide rackmount computer chassis out for servicing
- ◆ 18" extension length
- ◆ Sold in pairs.....75.00

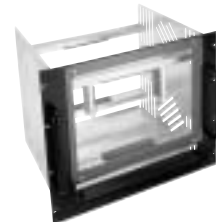

RM-MM Computer Monitor Rackmount

- ◆ Adjustable clamps accommodate most 14" to 17" monitors
- ◆ Clear plexiglass window protects screen
- ◆ Hinged front door provides access to controls
- ◆ 15.75" (9 space)

RM-KB Rackmount Computer Keyboard

- ◆ Includes high-quality 101-key AT style keyboard, trackball and padded wrist-rests
- ◆ Articulating arm provides effective cable management
- ◆ Complete with 12" keyboard and trackball cables, including PS/2 connectors and a DB9 serial adaptor.
- ◆ Hinged cable manager in rear
- ◆ Occupies 1.75" (1 space)



KB-SS Keyboard Sliding Shelf

- ◆ Rackmount shelf occupies 1 1/4" (1 space)
- ◆ Accommodates most standard small-pattern keyboards
- ◆ Articulating arm provides effective cable management
- ◆ Durable black powder coat finish

MIDDLE ATLANTIC

RSH SERIES CUSTOM RACKMOUNTS

STUDIO ACCESSORIES

1404

The Professional's Choice for Trimming Non-Rackmount Components

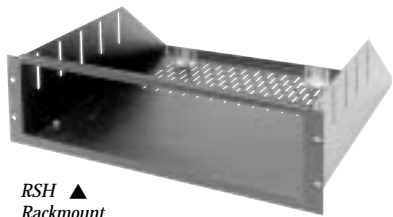

RSH ▲
Rackmount



▲
RSH shown with
optional clamp bars

- ◆ Install any component (up to 18 3/4" wide) in a standard 19" enclosure without making modifications
- ◆ Custom cut for a perfect fit and no gaps
- ◆ Over 6,000 component specifications are available in Middle Atlantic's database
- ◆ Racks include rear brackets, have a ventilated bottom, and assemble easily in minutes
- ◆ Bottom depths of 11 1/2", 14, 15 1/2", 17 1/2", or 20 1/2" are available
- ◆ Individual faceplates are also available in a black textured finish (SFACE), or a black brushed anodized finish (AFACE)
- ◆ Optional RSH clamps secure components to the shelf – rubber lining maintains a tight grip without scratching

RSH-4S Black textured anodized finish120.00

RSH-4A Black brushed anodized finish120.00



Ordering Instructions

- ◆ To see if the component you want to rackmount is available in Middle Atlantic's database of over 6000 models, simply go to www.middleatlantic.com and search their custom Rack Finder utility or, call us up at B&H and we'll be more than happy to check for you
- ◆ In the unlikely event that your component is not in the custom rack database, you can fax the measurements to Middle Atlantic

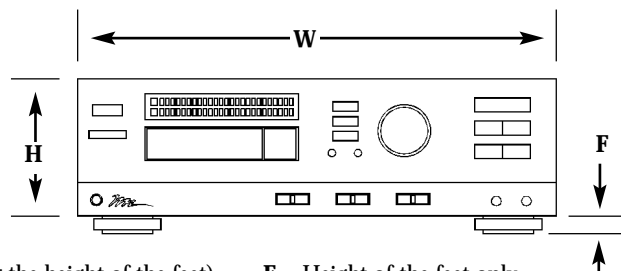

W = Faceplate width H = Faceplate height (not including the height of the feet) F = Height of the feet only

** W, H and F dimensions must be within 1/32". Depth must be within 1/8"

Wide Unit Shelf System

Accommodating components too wide to fit the 17 3/4" inside width of standard rackshelves, these shelf systems fit units up to 22 1/2" wide, and either bolt into millwork or to the mounting angles of standard rackrail. Occupies three rackspaces, the WUSS system comes complete with a pair of ears, a bottom, and appropriate assembly hardware.

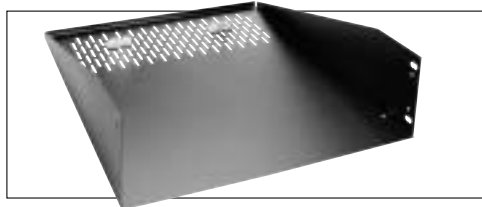

WUSS11.5	11.5" depth.....	54.00
WUSS15.5	15.5" depth.....	58.00
WUSS17.5	15.5" depth.....	60.00
WUSS20.5	20.5" depth.....	65.00

Trim Strips



shown
with
trim
strip
installed

shown
without
trim
strip
installed

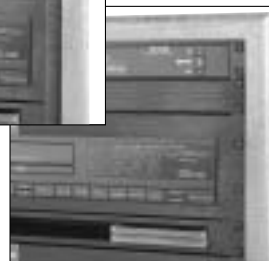

As a final aesthetic complement to any installation, finishing trim strips offer a quick, clean, and effective method of covering rack screws once the job is complete. Each channel-shaped trim strip measures 45 spaces (78 3/4" long), and features internal grooves that fit into the supplied snap washers. Offered in brushed black anodized or black powdercoat finish, trim strips are cut easily with a hacksaw. A cutting service is also available. Included decorative caps trim the ends, if required. Sold individually.

Part #	Description	Attachment Method	Price
TA	brushed black anodized	snap washers (8), end caps (4)	45.00
TS	black powder coat	snap washers (8), end caps (4)	20.00

* Works with all standard equipment mounting hardware except HW100 and HW500



www.bhphotovideo.com

MIDDLE ATLANTIC

MEDIA STORAGE

STUDIO ACCESSORIES

1405

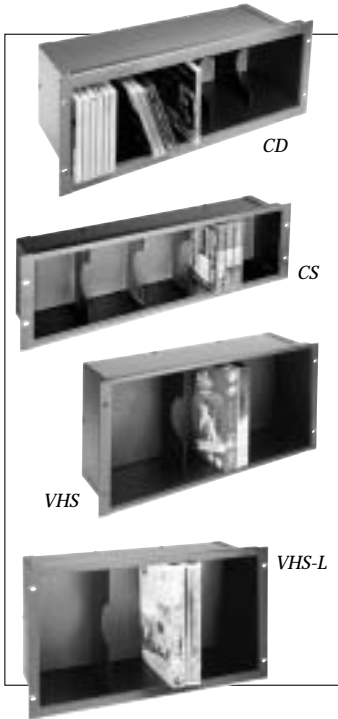

Front-Loading Media Holders

Store DATs, CDs, DVDs, VHS tapes, cassettes, LPs and other recorded media in our rackmount media holders. Partitioned to prevent the contents from tipping, each model features a 16-gauge flanged aluminum face and a brushed, black anodized finish. Selected models are available with a textured black powder coat. All stored media protrudes 3/8" to allow quick retrieval.

Part #	Fits	Height	Finish	Depth	Price
CD	40 CDs	7" (4 space)	brushed	5 3/4"	80.00
TCD	40 CDs	7" (4 space)	textured	5 3/4"	80.00
CS	25 audio cassettes	5 1/4" (3 space)	brushed	3"	85.00
DAT	27 DAT tapes	5 1/4" (3 space)	brushed	2 5/8"	82.00
VHS	14 VHS tapes in regular case	8 3/4" (5 space)	brushed	4 13/16"	88.00
TVHS	14 VHS tapes in regular case	8 3/4" (5 space)	textured	4 13/16"	80.00
VHS-L	13 VHS in padded case	10 1/2" (6 space)	brushed	5 5/8"	96.00
CD-1	6 CDs	1 1/4" (1 space)	brushed	5 1/2"	45.00
LP	LP's, binders	14" (8 space)	brushed	12 5/8"	150.00
DVD	28 DVDs	8 3/4" (5 space)	brushed	5 1/2"	99.00

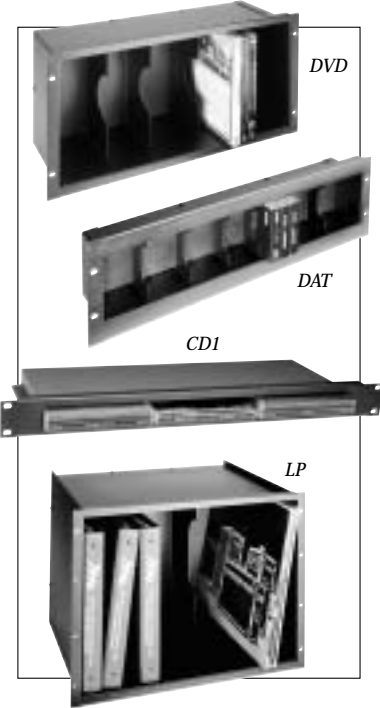

Heavy-Duty D and TD Series Drawers

Fully enclosed with inside dimensions measuring 15 1/2" wide by 14 1/2" deep, these drawers feature spring-loaded latches and rugged, straightforward construction. Faceplates come with a textured black powder coat (TD) or brushed and black anodized (D) finish.

Anodized Finish Part #	Textured Finish Part #	Racking Height
D2 115.00	TD2 110.00	3 1/2" (2 space)
D3 128.00	TD3 120.00	5 1/4" (3 space)
D4 137.00	TD4 128.00	7" (4 space)
D5 156.00	TD5 145.00	8 3/4" (5 space)

All D and TD Series Drawers are also available with installed keylocks.

Media Partitions for

D, TD, and UD Series Drawers

Partition your D, TD, and UD series drawers for media storage. Snap-together fit is also handy for small parts and miscellaneous hardware.

Part #	Fits	Accommodates	Price
DDATP	D2, TD2, UD2	84 DAT tapes, hardware	28.00
DCSP	D2, TD2, UD2	58 cassette tapes	28.00
DCDP	D4, TD4, UD4	103 compact discs	36.00
DVDP	D4, TD4, UD4	40 DVD discs	30.00
DVHSP	D3, TD3, UD3	24 VHS tapes	30.00



UD Series Drawers

Drawer contents always remain inside with the UD series fully enclosed rackmountable utility drawers. Full extension ball bearing slides smoothly extend a full 14" to reveal inside dimensions measuring 15 1/2" wide by 14 1/2" deep. Storage height is only 1/2 less than the actual racking height. Each model comes with a face mounted drawer pull. A user-installed latch and keylock are optionally available. Black powder coat finish.

Part #	Racking Height	Price
UD2	3 1/2" (2 space)	92.00
UD3	5 1/4" (3 space)	98.00
UD4	7" (4 space)	115.00

Keylocks and Latch

- KYLK User-installed UD keylock18.00
- LATCH User-installed UD latch13.00
- ACC-KEY Additional set of keys for KYLK ...29.00

Lockboxes

Safely secure gear in our rackmount LBX series lockboxes. 9" deep, 3 and 4 space models are offered with a durable black powder coat finish.

Part #	Racking Height	Depth	Price
LBX-3	5 1/4" (3 space)	9"	75.00
LBX-4	7" (4 space)	9"	82.00



MIDDLE ATLANTIC

ACCESSORIES

STUDIO ACCESSORIES

1406

RRF Rackrail

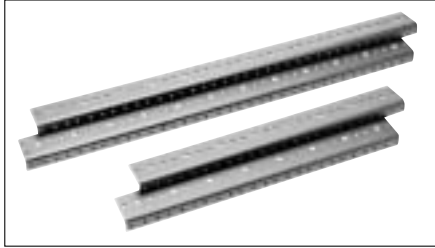

Measuring 1/8" thick, the all-steel RRF rack rail is threaded for 10-32 screws. With full hole spacing, they are sold in pairs and designed for use with 19 1/2" wide rough openings. Durable black powder coat finish, cutting service available.

Part #	Length	Racking Height	Price
RRF2	3 1/2"	(2 space)	6.95
RRF4	7"	(4 space)	10.95
RRF6	10 1/2"	(6 space)	15.60
RRF8	14"	(8 space)	17.95
RRF10	17 1/2"	(10 space)	21.50
RRF12	21"	(12 space)	25.00
RRF14	24 1/2"	(14 space)	28.00
RRF16	28"	(16 space)	30.00
RRF18	31 1/2"	(18 space)	32.00
RRF21	36 1/2"	(21 space)	36.50
RRF27	47 1/2"	(27 space)	44.78
RRF45	78 1/2"	(45 space)	72.50

High Density 24-Outlet 15 Amp Slim Power Strip

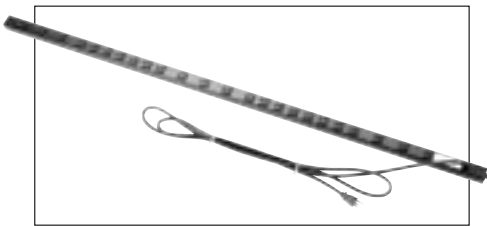

High-density power strip boasts a unique feature in that while containing 24 power outlets, 11 of these outlets have been spaced to accommodate plug-in power supplies, resulting in no wasted outlets! Measuring 1 1/4" deep by 1 3/8" wide, this power strip provides maximum useability while taking up a minimum of space. Ships with 10' power cord terminated with a NEMA 5-15P plug, 15 amp circuit breaker and mounting system PD-2415SC-NS.....**96.00**

WL-60 Magnetic Work Light

Designed for use when installing and servicing equipment, the WL-60 provides convenient illumination in rack enclosure interiors.



The unit features a strong magnetic base that attaches to any metal surface, and a quadruple-jointed support arm makes it easy to aim the light, which stays where you put it. The WL-60 includes a 60 watt "rough-service" bulb, aluminum shade with on/off switch,

and an ultra-long 18' line cord that eliminates the need for an extension cord.

WL-60.....58.00

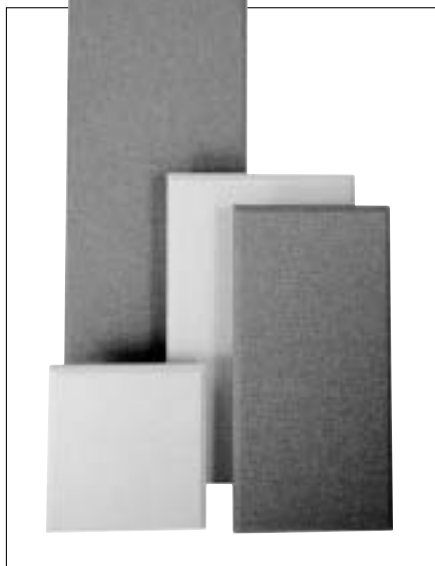

Acoustical Panels

Acoustic wall panels provide effective acoustic treatment for problem rooms. They are faced with 100% polyester fabric, which are easy to clean, and will not rip, tear, or crack like foam products. They feature resin-hardened edges which are beveled for aesthetics. In addition, due to superior materials used, AP series 2" thick panels offer the same sound absorbing rating as 4" thick panels. Acoustic panels are available in 4 sizes and two attractive colors, all 2" thick.

Gray Color Part #	Beige Color Part #	Size	Price
AP24X24G	AP24X24B	24" x 24"	118.00
AP24X48G	AP24X48B	24" x 48"	164.95
AP30X48G	AP30X48B	30" x 48"	199.95
AP30X84G	AP30X84B	30" x 84"	318.00

The Claw

The unique dual-size "claw" configuration of this versatile wall-mount cable hanger provides efficient storage for all cables large and small. Convenient side trays hold small items. 16" wide x 3 1/2" deep. Black powder coat finish.....**14.95**



MD-KB Computer Keyboard Tray

Designed for under-desk use, the MD-KB computer keyboard tray is equipped with a padded wrist support. The unit's built-in mouse tray can be pulled out to either the left or right side and retracts out-of-the-way when not in use. All mounting hardware included. (Does not work with MDV-CNR1 or MDV-CNR3.).....**99.95**



OMNIMOUNT

STAINLESS STEEL SERIES

Stainless Steel Speaker Mounts

For over 25 years OmniMount has been an innovator in the field of audio mounts. Today, the OmniMount name is synonymous with superior quality and has become the choice of professional installers and the brand most recommended by speaker manufacturers. Their mounts offer numerous advantages, including durable ergonomic designs, ease of installation and omni-directional positioning.

OmniMount's Stainless Steel series is a unique, top-of-the-line speaker mounting solution assembly, tops for functionality, safety, ease of installation, appearance, and multi-angle useage.

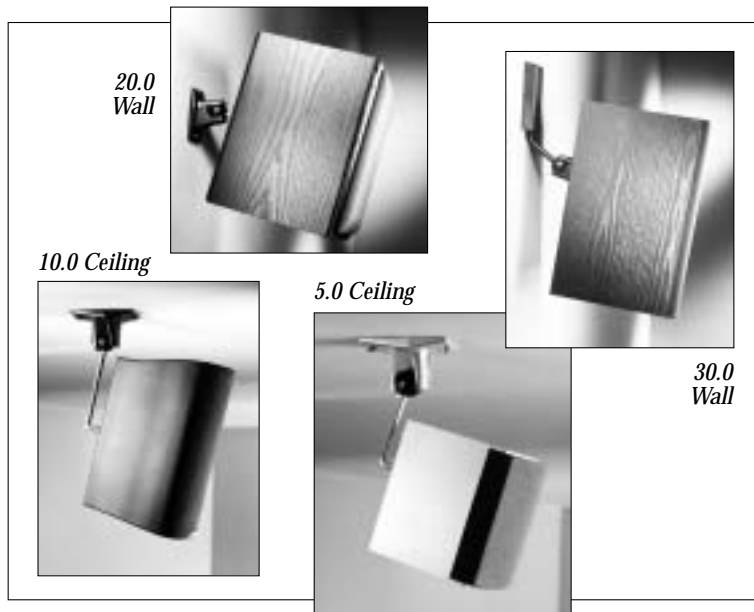

STUDIO ACCESSORIES

1407

FEATURES

- ◆ Built with stainless steel hardware for strength, durability, and quality. Perfect for outdoor as well as indoor use
- ◆ Critical areas are polymer injected for less resonance, producing a more precise range of sounds
- ◆ All-inclusive combination of threads and/or mounting plates is designed to fit any model of speaker
- ◆ OmniMounts patented ball joint rotates and holds in any direction making it the most flexible solution
- ◆ Unique black, white or gray braided sheath included to hide steel finish if desired



5.0 Wall/Ceiling

- Contains both wall and ceiling mount options
- Drill bit and all necessary mounting hardware included
- Supports speaker up to 5 lbs
- Stainless Steel shaft with 4mm and 5mm thread
- Available in Black, White, or Grey.....**199.95**

10.0 Wall/10.0 Ceiling

- Sold separately as wall or ceiling mount, the 10.0 mounts are designed for bookshelf-size speakers
- Drill bit and all necessary mounting hardware included
- Supports speakers up to 10 lbs
- Stainless Steel shaft with 1/4"-20 thread
- Available in Black or White

20.0 Wall/20.0 Ceiling

- Sold separately as wall or ceiling mount
- Stainless Steel shafts and all necessary hardware included.
- Supports speakers up to 20 lbs.
- Available in Black or White**319.95**

30.0 Wall/30.0 Ceiling

- Sold separately as wall or ceiling mount
- Unique ball and clamp assembly
- Supports speakers up to 30 lbs
- Available in WA, WB, CA, & STMP configurations
- 1/2"-20 thread pattern
- Available in black or white

60.0 Wall/60.0 Ceiling

- Sold separately as wall or ceiling mount
- Includes all necessary mounting hardware
- Supports speakers up to 60 lbs.
- Available in WA, WB, CA, & STMP configurations
- 5/8"-18 thread pattern
- Available in black or white

120.0 Wall/120.0 Ceiling

- Sold separately as wall or ceiling mount
- Includes all necessary mounting hardware
- Supports speaker up to 120 lbs
- Available in WA, WB, CA, & STMP configurations
- 1/2"-20 thread pattern
- Available in black or white

QUIK LOK

WS-500

STUDIO ACCESSORIES

1408

All-Steel Modular Workstation System

The arc-welded, all-steel WS-500 is ideal both for the musician who needs a versatile, fully adjustable work place, as well as for home recording, project studios and schools. It features height adjustable shelves and tiers, and is capable of securely holding plenty of audio and computer equipment. All shelves are supplied with soft rubberized cushions that hold the gear firmly in place. Assembly requires no tools.

The WS-500 includes: WS-550, WS-561, WS-551, WS-552, WS-553, two WS-554's, QL-648 and QL-636

Height Range42 to 49.7" Depth Range26.8 to 31.3"
Width Range22.7 to 46.4" Weight64 lb.



\$422⁵⁰

COMPONENTS

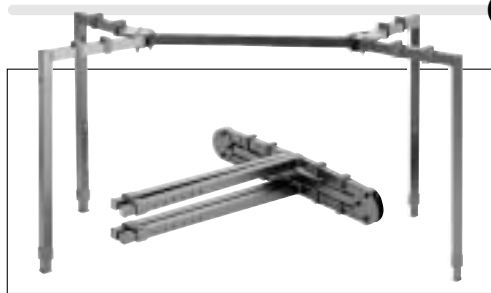

WS-550

Height Adjustable Base Unit

Used as the base for the WS-500 workstation. All legs are independently height adjustable and can be swung into position to conform to any keyboard, synthesizer or mixer.

Height Range24.25 to 32.5" Folded Height24.6"
Width Range29.2 to 46.4" Frame Tubing Size30mm
Depth Range17.3 to 27.4" Weight Capacity250 lb.
Folded Width29.2" Weight18 lb.

WS-561

Add-on Vertical Back Spine for WS-550

Optional spine kit that converts a WS-550 to a modular workstation starter frame for customized configurations. This allows use of all WS-500 workstation shelves.

Height Range42" to 49.7" Width Range27.2" Weight14 lb.

WS-551 / WS-552

Utility Shelves

Solid metal, height adjustable, utility shelf can be used for holding mixers, drum machines or multi-track recorders, etc. Shelves can be rotated 360° for exact positioning.

Shelf Depth11.8" (WS-551); 9.8" (WS-552) Weight Capacity40 lb.
Shelf Width11.8" (WS-551); 19.6" (WS-552) Weight4.4 lb.(WS-551); 5.5 lb." (WS-552)
Height Adjustment Range, measured from main tier to top of shelf0 to 8"

WS-553

Width Adjustable, 90° Fixed-Angle Speaker Shelves

Arc-welded steel construction with rubber padding. Height-adjustable anywhere along workstation spine with a rubber-coated attaching clamp that won't scratch the stand.

Shelf Depth ...11.8" Shelf Width11.8" Weight Capacity60 lb. (30 lb. each shelf)
Weight9 lb. Width Adjustment Range, measured from outside edge of shelves26.4" to 43.3"

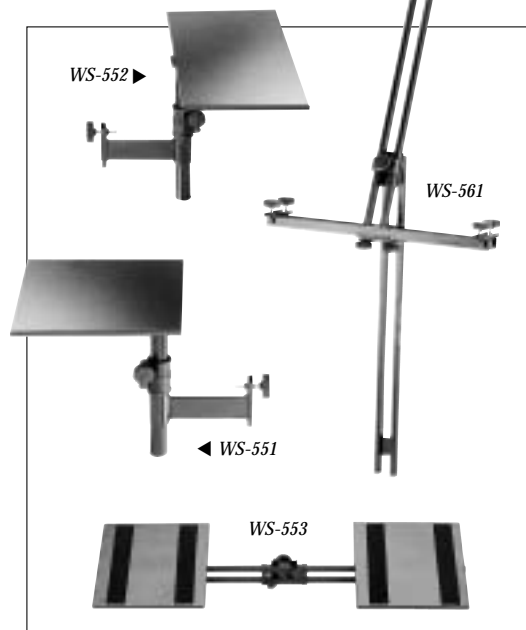

For Any Inquiries Regarding Your Order, Call Our Customer Service:
(800) 221-5743 • (212) 239-7765 • FAX: (800) 947-2215 • (212) 239-7549

QUIK LOK

WS-500

STUDIO ACCESSORIES

1409

WS-554

Small, 90° Fixed-Angle Shelf

For the lower portion of the vertical back spine. Features a perforated metal surface and a rubber-coated attaching clamp**29.95**

QL-648

Small, 90° Fixed-Angle Shelf

Features a perforated metal surface and a rubber-coated attaching clamp**25.95**

QL-636

Large, Tilt-Adjustable Tier

Delivers 5 usable angle positions: 90°, 81°, 72°, 63°, and 54°. Rubber rest pads hold equipment firmly in place**31.95**

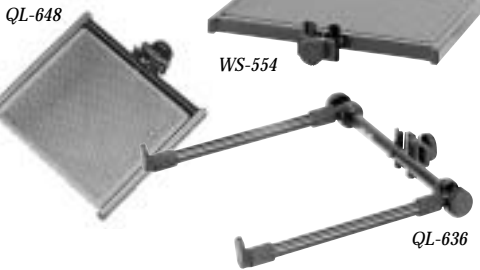

TIER AND SHELF SPECS

Model	Width	Depth	Weight Capacity	Weight
WS-554	18.5"	11.8"	50 lb.	4 lb.
QL-648	13"	11.8"	50 lb.	3.3 lb.
QL-636	17.7"	13.8"	50 lb.	3.1 lb.

"H"-STYLE KEYBOARD STANDS

The QL-699 and QL-695 "H" stands offer sit down keyboard players comfort and flexibility. They are great for rehearsal rooms as well as project and home setups. The first tier is tilt and width adjustable to accommodate any keyboard up to 88 notes. Additional tiers are height and tilt adjustable and can hold 61 or 49 note keyboards up to 16.5" deep. Both models fold flat without for easy transport.

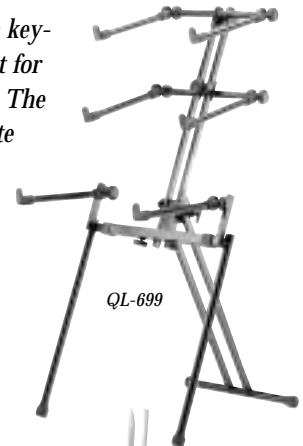

QL-699

Total Set-up Top to Bottom Height: 53.5"
Folded Height: 58.7"
Total Set-up Front to Back Depth: 29.3"
Side to Side Width Adjustment (first tier): 20.6" to 31.7"
Tilt Adjustment Angles (first tier): 90°, 80°, 70°, 60°
Tilt Adjustment Angles Additional Tiers: 90°, 81°, 72°, 63°, 54°
Weight Capacity (1st tier): 75 lb.
Weight Capacity of Each Additional Tier: 60 lb.
Weight: 25.3 lb. (QL-699); 22 lb. (QL-695)



◀ The QL-690/0, a stand-alone slant-back column display stand accepts the same optional accessories as the QL-699 and QL-695. (53" set-up height, 23.6" base set-up depth. Weighs 21 lbs.)

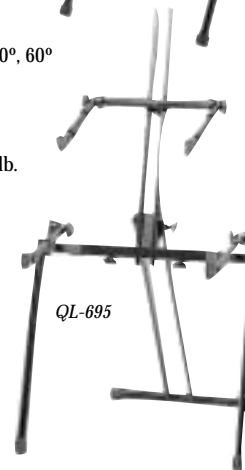

QL-695

QL-699.....**219.95** QL-695**189.95**

Optional Accessories for the WS-500 and "H" Stands

Tiers

Additional tiers feature rubber rest pads that hold equipment firmly in place and a rubber-coated attaching clamp will not scratch stand.

QL-634 Small Fixed-Angle Tier**22.50**

QL-635 Large Fixed Angle Tier**25.95**

QL-636S Short tilt adjustable tier. Usable angle positions are 90°, 81°, 72° 63°, 54°**28.50**

Shelves

Additional shelves feature a perforated metal surface and a rubber-coated attaching clamp.

QL-649 Large, 90° fixed-angle shelf. Frame size is 30 x 15mm**28.50**

QL-650 Extra large, 90° fixed-angle shelf for computer monitors**37.50**

TIER AND SHELF SPECS

Model	Width	Depth	Weight Capacity	Weight
QL-634	13"	11.8"	50 lb.	2.2 lb.
QL-635	18.5"	11.8"	50 lb.	2.6 lb.
QL-636S	17.7"	10"	50 lb.	2.6 lb.
QL-649	18.5"	11.8"	50 lb.	4 lb.
QL-650	17.7"	17.7"	60 lb.	7.1 lb.

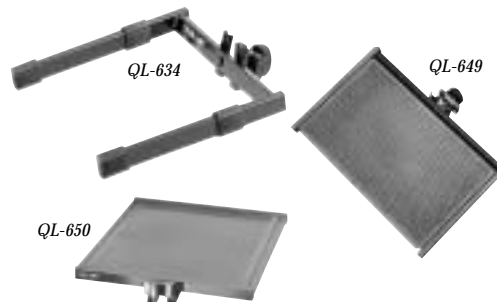

Misc. Furniture

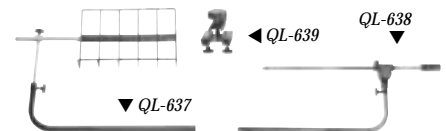

QL-637 Adjustable Sheet Music Holder. Requires QL-639 Clamp. 12" width; 8.6" top to bottom height; 2" bottom lip depth. Weighs 2.4 lb.**29.95**

QL-638 Fully Adjustable Fixed Length Mic Boom. Requires QL-639 Clamp. 24.8" boom length. Weighs 3 lb.**28.50**

QL-639 Accessory Clamp. Needed to attach QL-637 and QL-638 mic boom. Only one clamp is needed when using both the QL-637 and QL-638**19.95**

ORDER & INFO. (212) 444-5088 • FAX: (212) 239-7770 (800) 947-7008
 1-800-875-6951 • www.bhphotovideo.com



QUIK LOK

Z SERIES WORKSTATIONS

STUDIO ACCESSORIES

1410

Z-555 Expandable Music Project Station

The Z-555 workstation delivers sleek, attractive styling that is a perfect compliment to any home or studio environment. All work shelves and crossbars are height adjustable, and the speaker shelves may be mounted inward to save space. Quik Lok offers a wide range of options for musicians to configure their work area. Add computer peripherals, speakers, rack equipment, music keyboards, mixers, etc. The Z-555 has a computer-welded steel frame and 3/4" thick laminate work surfaces.



\$204⁹⁵

Z-555 SPECIFICATIONS

MAIN SHELF	
Height*	26.75", 27.75", 28.75"
Width	51.2"
Depth	27.5"
Thickness	3/4"
MONITOR SHELF	
Height *	41"
Width	11.8"
Depth	11.8"
Top Crossbar Height	36", 37", 38"
FRAME	
Width Monitor Shelves Turned In	55"
Width Monitor Shelves Turned Out	75.6"
Depth of Legs	35.4"
Weight Capacity	See capacity of components

* positions from floor

Z-Shaped Designer Series Computer Furniture

Ergonomically designed triple-shelf workstations for maximum comfort and efficiency. Sleek, attractive styling adds an elegant look to any work environment. All models feature scratch-resistant 3/4" thick laminate shelves, while the computer-welded heavy-duty steel frame provides tremendous weight capacity, accomodating all kinds of computer equipment. Shelves are dove gray with black rubber edge moldings



Z-750R

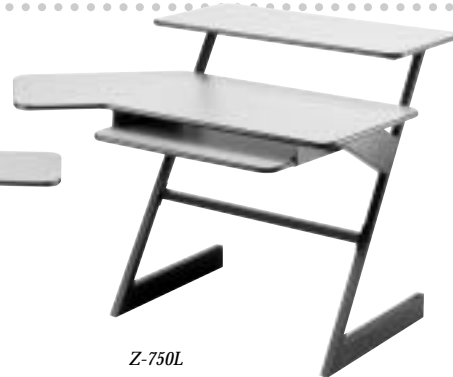

Z-750L



Z-760



Z-250

Z-750R - Triple Shelf Workstation with 45° Right-Angled Main Shelf**227.50**

Z-750L - Triple Shelf Workstation with 45° Left-Angled Main Shelf**227.50**

Z-250 - Triple Shelf Workstation.....**218.95**

Z-760R - Triple Shelf Workstation with 45° Right-Angled Main Shelf and Height-Adjustable Top Shelf.....**259.95**

SPECIFICATIONS

Model	Z-750R	Z-750L	Z-250	Z-760
MAIN SHELF				
Height*	28.5"	28.5"	28.9"	28.5"
Width	52.8"	52.85"	44"	52.8"
Depth	22.2"	22.2"	22"	22"
Thickness	3/4"	3/4"	3/4"	3/4"
TOP SHELF				
Height *	36"	36"	36"	34.4" - 49"
Width	38.6"	38.6"	38.6"	38.6"
Depth	17.1"	17.1"	17.1"	17.5"
Thickness	3/4"	3/4"	3/4"	3/4"
PULL-OUT SHELF				
Height*	25.8"	25.8"	25.8"	25.8"
Width	27.4"	27.4"	27.4"	27.4"
Depth	14"	14"	14"	14"
Thickness	3/4"	3/4"	3/4"	3/4"
FRAME				
Width	33.6"	33.6"	33.6"	33.6"
Leg Depth	22.3"	22.3"	22.3"	22.3"

* from floor



EQUIPMENT LEASING AVAILABLE

QUIK LOK

Z SERIES WORKSTATION ACCESSORIES

OPTIONAL SHELVES

Z-710 Mica Shelf

Attaches to the lower crossbar. The Z-710 can hold computer and audio equipment. Off-center design allows shelf to be mounted either closer or further away from user. Available in dove gray color.....**49.95**

Z-711 Perforated Metal Shelf

Attaches to the lower crossbar. Off-center design. Available in black color only.....**29.95**

Z-712 Sliding Keyboard Shelf

Mounts to the main tier of the Z-555. Holds all computer keyboards and most 25 to 37 note keyboard controllers. 2.5" clearance from the top of the main tier to the top of the sliding shelf. Dove gray color. For the Z-555 only**57.95**

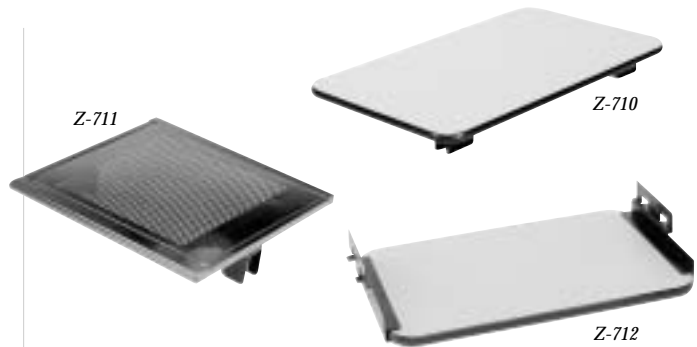

SHELF SPECIFICATIONS

Model	Width	Depth	Thickness	Weight Capacity	Weight
Z-710	30"	18.3"	.71"	90 lb.	13.3 lb.
Z-711	13.9"	13"	N/A	75 lb.	3.3 lb.
Z-712	30"	14"	.71"	25 lb.	11.1 lb.

STUDIO ACCESSORIES

OPTIONAL ACCESSORIES

ZM-55 Lower Crossbar

Used to mount an optional shelf or equipment holder on the lower section of the Z-555. The ZM-55 is 51.1" wide, has a tube size of 30 x 50mm, and weighs 5.3 lbs. It attaches to the stand frame 13.4" from the floor. Available for the Z-555 only.....**44.95**

Z-709 Computer Holder

Mounts virtually any CPU tower to all Quik Lok "Z" stands. The Z-709 is 15.75" high, 8.6" wide, 13.8" deep and weighs 3.3 lbs. It has a weight capacity of 44 lb**39.95**

ZM-97 Tilt & Width Adjustable Tier Set

Holds multi-track recorders, mixers, drum machines, keyboards or midi data input devices on the top crossbar of the Z-555 workstation. The ZM-97 features the "Dino-Bite" locking disc for secure, non-slip tilt adjustments. It's dimensions are: 14.3" depth; 90°, 80°, 70°, 60° usable angle positions; and 60 lb. weight capacity. It weighs 4 lbs**34.95**

ZM-99 "Z" Stand Caster Kit

2 locking and 2 non-locking casters**19.95**

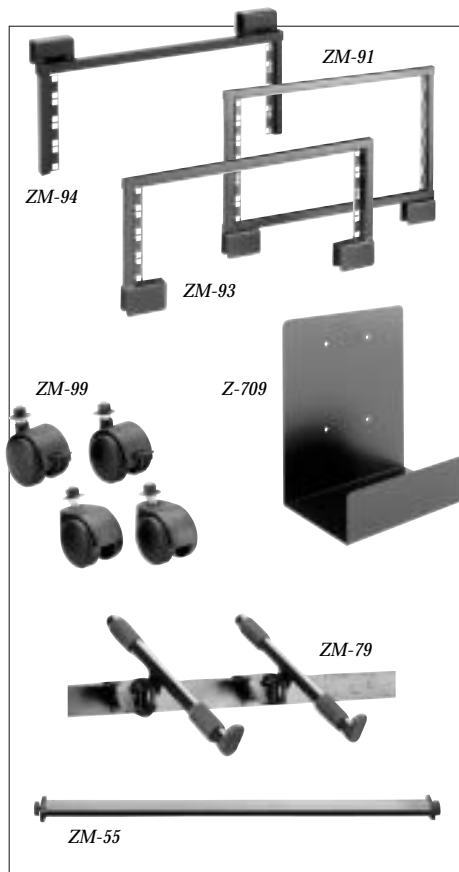

Rack Equipment Holders

Available in 6-space and 4-space versions, these rack equipments holders and are used to hold power amps, outboard gear, tone generators / samplers or any rack mountable equipment.

ZM-91 - 6-Space Holder
Rests securely on top of the lower crossbar. It cannot be used with the Z-712 pull-out computer shelf.....**34.95**

ZM-93 - 4-Space Holder
4-space version of the ZM-91**33.50**

ZM-94 - 4-Space Holder
Mounts from underneath the "Z" stand crossbar.....**44.950**

RACK HOLDER SPECS

Model	Width	Depth	Weight Capacity	Weight
ZM-91	20.7"	12.6"	120 lb.	4.9 lb.
ZM-93	20.7"	9"	80 lb.	3.3 lb.
ZM-94	20.7"	9"	80 lb.	3.3 lb.

ZM-90

Power Strip Holder

Will secure virtually any non-rackable A/C power strip on the lower crossbar, for neater cable management**19.95**

1411



QUIK LOK

KEYBOARD STANDS

STUDIO ACCESSORIES

1412

Keyboard X-Stands with the Quik Lok Locking Mechanism

Keyboard stands that use the "Original" locking disc are by far the most popular among the most demanding professionals. This battle-tested disc system has been accepted as the industry standard since 1978. Musicians around the world have relied upon this line of stands for their durability, ease of use and dependability.

Height and width positions
QL-606 / QL-646
Height: 36.6", 34.5", 31.2", 27.4", 23"
Width: 14.4", 19.8", 24.5", 28.7", 2.3"
BS-616
Height: 42.6", 39.5", 35.4", 30.6", 25"
Width: 16.5", 22.5", 27.8", 32.7", 36.8"

X-STANDS			
Model	QL-606	QL-646	BS-619
Leg Depth	20"	20"	19.5"
Tier Depth	13.75"	13.75"	13.75"
Folded Height	38.75"	38.75"	28"
Weight Capacity	180 lb.	200 lb.	180 lb.
Weight	7.3 lb.	10.6 lb.	9.5 lb.
Brace Tube Size	30 x 15mm	30 x 15mm (x2)	25 x 25mm (upper) 30 x 30mm (lower)
Tier Tube Size	30mm	30mm	30mm

QL-606 X-Stand
Single-Brace, Single Tier**44.95**

QL-646 X-Stand
Double-Brace, Single Tier....**64.95**

BS-619 X-Stand
Portable Full-Sized
Keyboard with Collapsible
Telescopic Tiers**64.95**

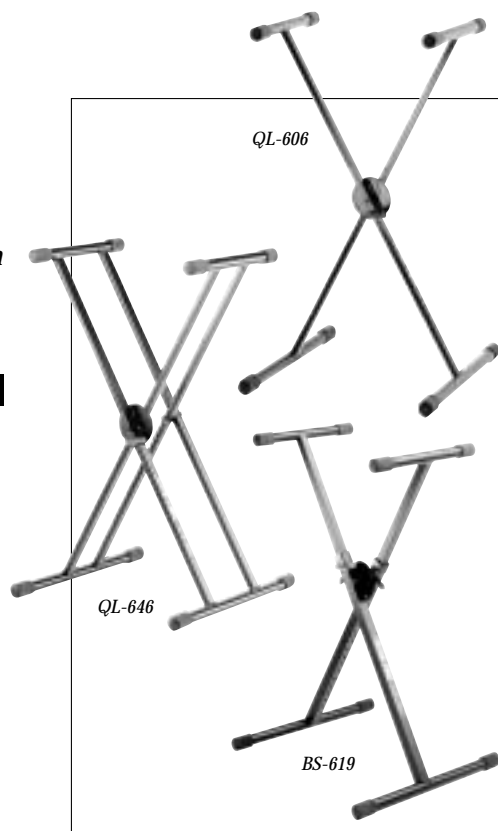

X-SERIES OPTIONAL ACCESSORIES

Tiers

Second Tiers offer 5-position height adjustment and allow a QLX-4 Mic boom or QLX-5 music holder to be added.

QLX-2 Height Adjustable, Fixed-Angle Second Tier - 90° fixed angle allows top keyboard to be moved closer or further away from user**29.95**

QLX-3 Height, Tilt and Angle Adjustable Second Tier - with four-position angle adjustment**37.50**

QLX-1 Height, Tilt, Angle and Depth Adjustable Second Tier - with 4-position angle adjustment and 7.6" depth adjustability**Call**

TIER SPECS			
Model	Depth	Weight Capacity	Weight
QLX-2	13.38"	100 lb.	4 lb.
QLX-3	17.3"	75 lb.	5.5 lb.
QLX-1	15.7"	75 lb.	6.6 lb.

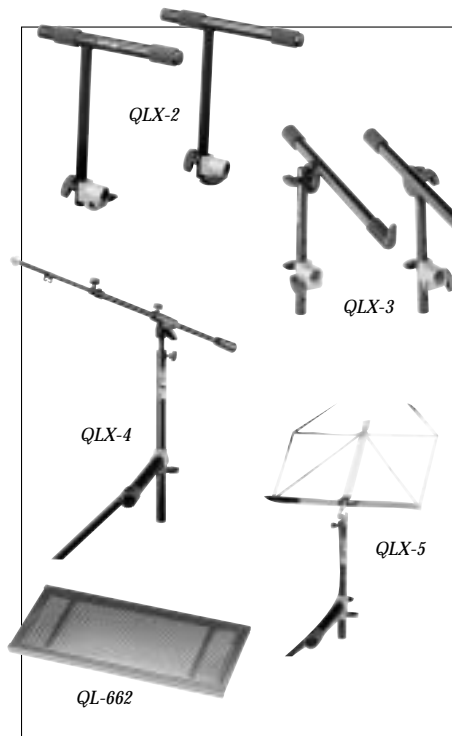

QLX-4 Fully Adjustable Telescopic Mic Boom - swivels to any position, five position height adjustments, extends to 40.5"**29.95**

QLX-5 Fully Adjustable Sheet Music Holder - Five position height adjustment. Folds easily for transport**33.50**

QL-662 Large Metal Shelf - Perforated metal shelf with reinforced steel bracing converts any full-sized X stand or second tier into a convenient table for holding drum machines, multi-track recorders or any kind of table top equipment. The QL-662 can be used on the following X stands and tiers: T-10, T-20, T-14, QLX-11, QLX-21, QLX-2, QL-606, QL-609, QL-646 & BS-619**54.95**

QLX-4, 5 & QL-662 SPECS				
Model	Width	Depth	Height Positions	Weight
QLX-4	—	—	11.25", 10.2", 8.9"*	2.4 lb.
QLX-5	17.7"	2.3"◊	6.5" to 11.25"	5.5 lb.
QL-662	28"	15.4"	—	10 lb.

* from top of tier to boom swivel ◊ Boom Lip depth



www.bhphotovideo.com

QUIK LOK

KEYBOARD STANDS

Pro Series Heavy-Duty X-Stands with Locking Disc System

The absolute hands-down choice of professional musicians the world over because of their adjustability, strength and reliability. All stands feature the "Original" locking disc system and super heavy-duty 30 x 30mm steel tube bracing for extra sturdiness and structural support. The Pro Series stands are capable of holding the heaviest keyboards safely and securely.

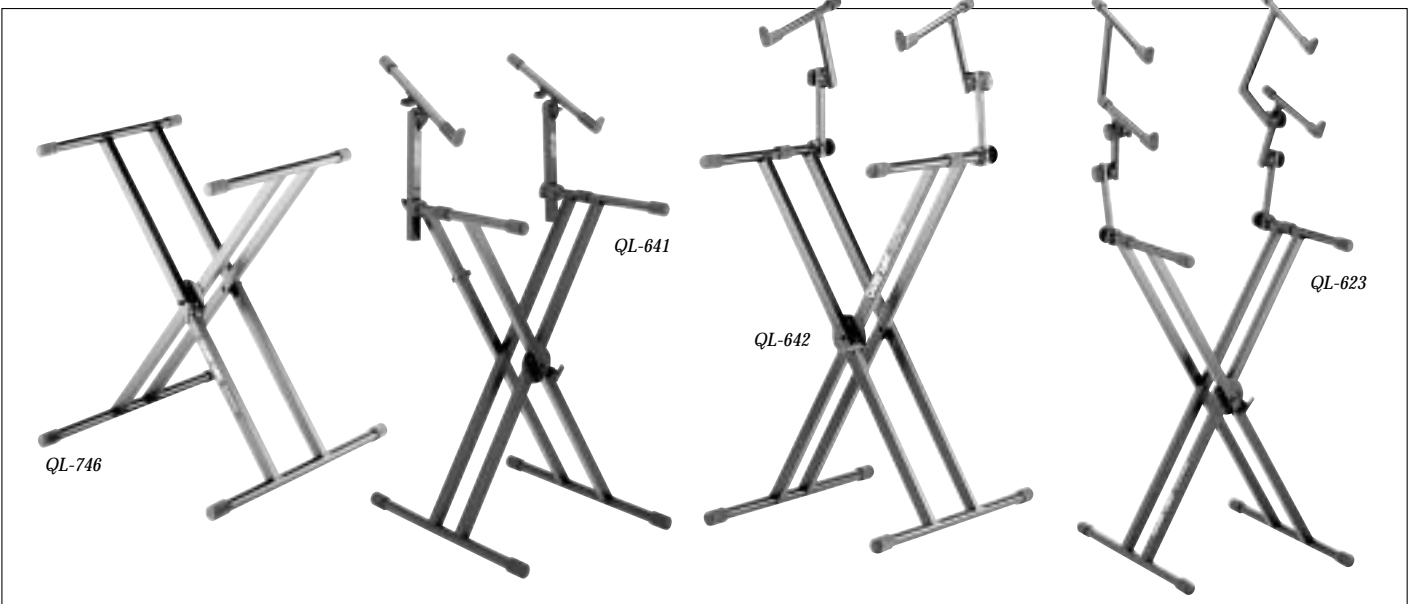

STUDIO ACCESSORIES
1413

PRO-SERIES X-STANDS SPECIFICATIONS

Model	QL-746	QL-641	QL-642	QL-623
Leg Depth	26"	26"	26"	26"
Main Tier Depth	20"	17.9"	17.9"	17.9"
Second Tier Depth	—	15.8"	15.8"	12"
Third Tier Depth	—	—	—	12"
Second Tier Angles	—	90°, 77°, 64°, 51°	90°, 77°, 64°, 51°	90°, 81°, 72°, 63°, 54°
Third Tier Angles	—	—	—	90°, 81°, 72°, 63°, 54°
Folded Height	40.4"	40.4"	40.4"	40.4"
Weight Capacity	260 lb.	265 lb. (overall) 75 lb. (2nd tier)	265 lb. (overall) 75 lb. (2nd tier)	265 lb. (overall) 60 lb. (2nd & 3rd tiers)
Weight	14.5 lb.	20 lb.	20 lb.	24 lb.
Brace Tube Size	30 x 30mm	30 x 30mm	30 x 30mm	30 x 30mm
Tier Tube Size	30mm	30mm	30mm	30mm

Height and width positions

<p>■ QL-746 / QL-641</p> <p>Height: 38", 34.5", 32", 27.8", 23"</p> <p>Width: 15.5", 20.9", 25.9", 30.4", 34.1"</p>
<p>■ QL-642 / QL-623</p> <p>Height: 38", 34.5", 32", 27.8", 23"</p> <p>Width: 15.5", 20.9", 25.9", 30.4", 34.1"</p>

QL-746 X-Stand

Heavy-Duty Double Brace, Single Tier.

Options: QLX-1 (adjustable second tier), QLX-2 (height-adjustable fixed-angle second tier), QLX-4 (telescopic mic boom), QLX-5 (sheet music holder), and QL-662 (large metal shelf)**72.50**

QL-642 X-Stand - Heavy-Duty Double Brace, with Height and Tilt Adjustable Second Tier.

Options: QLX-3 (adjustable second tier), QLX-4 (telescopic mic boom) and QLX-5 (sheet music holder)**113.50**

QL-641 X-Stand

Heavy-Duty, Double Brace with Height, Depth and Tilt Adjustable

Second Tier. Options: QLX-1 (adjustable second tier), QLX-3 (adjustable second tier), QLX-4 (telescopic mic boom) and QLX-5 (sheet music holder)**119.95**

QL-623 X-Stand

Heavy-Duty, Double Brace with Tilt Adjustable Second and Third

Tier. Options: QLX-4 (telescopic mic boom) and QLX-5 (sheet music holder)**139.95**

RAXXESS

STUDIO RACKS and ACCESSORIES

STUDIO ACCESSORIES

1414

ER ECONOMY RACKS

The simplest of designs, these knock down economy racks are black oak laminate over 5/8" medium density fiberboard. They provide a very economical yet attractive means for rack mounting audio gear in home studios or smaller installations. Assembly hardware and 11-gauge steel rack rail are provided. An optional swivel base (S-10) allows for 360° rotation for either the ER-8 or ERS-10. Perfect for use on table or desktop. Furniture grade nylon hooded casters are optional on all models.

Model	Rack Unit	Depth	Width	Height	Price
ER-4	4	15.75"	20.50"	8.625"	69.95
ER-8	8	15.75"	20.50"	15.875"	83.95
ER-12	12	15.75"	20.50"	22.875"	89.95
ER-16	16	15.75"	20.50"	29.875"	97.95
ER-20	20	15.75"	20.50"	36.875"	106.95
ER-8-18	8	18"	20.50"	15.875"	92.95
ER-12-18	12	18"	20.50"	22.875"	99.95
ER-16-18	16	18"	20.50"	29.875"	106.95
ER-20-18	20	18"	20.50"	36.875"	114.95
S-10 Swivel base.....	19.95	Casters Set of 4.....		58.95	



ER SLANTED ECONOMY RACKS

These economy racks are constructed with heavy duty 3/4" medium density fiberboard, attractively finished with a black oak laminate. All three units are shipped knocked down and assemble in minutes with the hardware kit provided. Rack rail included is of 11-gauge, cold rolled steel. Furniture grade casters are standard equipment on these slant racks. A great combination of form and function.



Model	Rack Spaces	Top Depth	Bottom Depth	Width	Height	Price
SLANTED RACKS						
ERS-10	10	12.625"	16.5"	20.50"	20.375"	104.95
ERS-18	18	12.5"	18"	20.50"	38.75"	153.95
SLANTED over STRAIGHT RACKS						
ER-12-8	20	8.25"	15.35"	20.50"	39"	153.95
ER-12-16	28	8.65"	15.75"	20.50"	53"	195.95



SCDR Security Door

Steel security door mounts to rack rail. Available in 8, 12, 16 and 20 spaces to match the ER and ERK series racks. Includes key locks and all hardware.

SCDR-8B for ER-8 and ERK-858.95

SCDR-12B for ER-12 and ERK-1264.95

SCDR-16B for ER-16 and ERK-1678.95

SCDR-20B for ER-20 and ERK-2089.95



ERD Economy Rack Door

Attractive smoked 3/16" plexi door to fit the economy racks. Textured powder coat finish with keyed lock. Attaches easily, and comes in sizes to fit the ER-8, 12, 16 or 20.

ERD-8 for ER-858.95

ERD-12 for ER-1281.95

ERD-16 for ER-1699.95

ERD-20 for ER-20125.95



For Any Inquiries Regarding Your Order, Call Our Customer Service:
(800) 221-5743 • (212) 239-7765 • FAX: (800) 947-2215 • (212) 239-7549

RAXXESS

STUDIO RACKS and ACCESSORIES

ERK ELITE RACKS

The Elite Series of fine audio racks are of knock down construction using the highest grade of fused 3/4" melamine. Available in 4, 8, 12, 16, and 20 spaces with a straight front or 16, 20 and 24 spaces slanted, as well as a 12 over 8 spaces configuration. They come equipped with 11-gauge steel rack rail and the finest knockdown furniture hardware available. Edges are attractively trimmed in solid oak or maple, oiled and rubbed to enhance the warmth of the wood. Available in ebony fleck and maple. Furniture grade casters are standard on 16 spaces and larger.

STRAIGHT MODELS

Model	Rack Spaces	Depth	Width	Height	Height w/casters	Price
ERK-4	4	14"	20.75"	8.875"	—	1049.95
ERK-8	8	15.875"	20.75"	16.875"	—	125.95
ERK-12	12	15.875"	20.75"	23.875"	—	139.95
ERK-16	16	15.875"	20.75"	30.875"	32.625"	153.95
ERK-20	20	15.875"	20.75"	37.875"	39.625"	167.95

SLANT MODELS

Model	Rack Spaces	Depth Top	Depth Bottom	Width	Height	Height w/casters	Price
ERK-165L	16	15"	18"	20.75"	33.50"	35.25"	195.95
ERK-20SL	20	14.25"	18"	20.75"	40.50"	42.25"	209.95
ERK-24SL	24	13.25"	18"	20.75"	47.50"	49.25"	223.95
ERK-12/8	20	9"	15.875"	20.75"	40.25"	42"	229.95



STUDIO ACCESSORIES

1415

SPEAKER STANDS

ERSS Economy Speaker Stands

These monitor stands are ideal for any studio and are constructed of 3/4" furniture grade hardboard, finished in a black oak laminate. The speaker platform and base are 12" square. The bottom is easily removed to allow the 5" center post to be filled with bagged sand for acoustical de-coupling. Sold in pairs, these stands are shipped knocked down in one box and assemble in minutes. Sold in pairs.

ERSS-36 36" speaker stands.....pair 99.95 ERSS-42 42" speaker stands.....pair 107.95



ESS Elite Speaker Stands

Elite speaker stands are sure to complement the aesthetics of any room or studio. They are attractively constructed from fused melamine. The speaker platform and base are edged with solid oak or maple that is sealed with linseed oil to enhance the warm wood finish. The stands are either 36" or 42" tall and both the speaker platform and base are 12" square. These stands are sold in pairs and are shipped knocked down. Assembly is simple. Bagged sand may be added to the 5 x 5" center post for acoustical de-coupling. Sold in pairs.

ESS-36B 36" ebony fleck speaker stands...129.95

ESS-36M 36" maple speaker stands.....129.95

ESS-42B 42" ebony fleck speaker stands...136.95

ESS-42M 42" maple speaker stands.....136.95

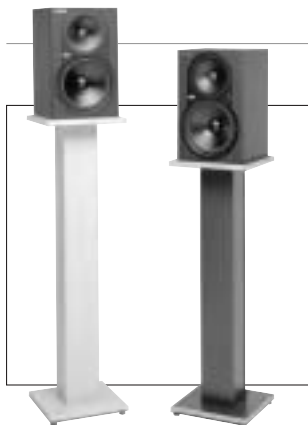

RAXXESS

CONFIG-U-RAXX

Modular Workstation Furniture System

STUDIO ACCESSORIES

1416

The Config-U-Raxx studio furniture system from Raxxess is a completely modular workstation designed to compliment the modern studio environment. The Config-U-Raxx line consists of an array of desktop surfaces, side wings and shelves, as well as add-ons such as doors and keyboard trays. Each component can be easily interfaced with any other component in the system, allowing for an almost endless variety of configurations. Future expansion of the system will be just as easy. A wide range of components allows a system to be configured to suit any room size and shape, while the new height adjustment system allows any desktop surface to be adjusted from 26" to 31" above the floor.



These features make the Config-U-Raxx system just as comfortable for the MIDI composer as it is for the audio engineer. The Config-U-Raxx line consists of an array of desktop surfaces, side wings and shelves, as well as add-ons such as doors

and keyboard trays. Each component can be easily interfaced with any other component in the system, allowing for an almost endless variety of configurations. Future expansion of the system will be just as easy.

Supported by an all steel substructure, this furniture is designed to provide years of trouble-free service and rock-solid performance. The Config-U-Raxx system is available in maple and ebony fleck finishes with silver T-mold trim. All steel surfaces are coated with an attractive silver hammer tone finish.



FEATURES

- ◆ All steel substructure
- ◆ Metal portions finished with an attractive Silver "Hammertone" finish
- ◆ Steel side wing racks available in your choice of 2 heights:
 - ◆ 12 rack spaces - 26" height
 - ◆ 14 rack spaces - 30" height
- ◆ Maple or Ebony side wing racks available in 14 rack spaces
- ◆ All center desks are adjustable in height to fit either height side wings

The Config-U-Raxx line consists of an array of desktop surfaces, side wings and shelves, as well as add-ons such as doors and keyboard trays. Each component can be easily interfaced with any other component in the system, allowing for an almost endless variety of configurations. Future expansion of the system will be just as easy.

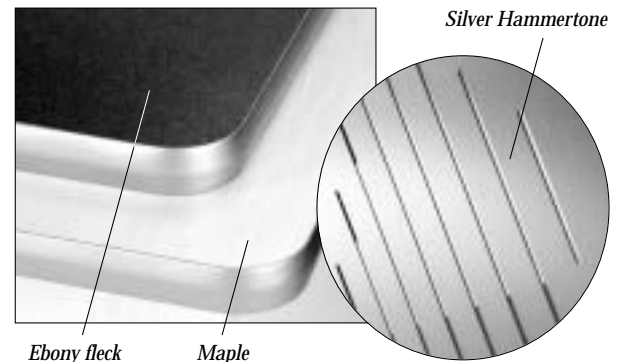

For Any Inquiries Regarding Your Order, Call Our Customer Service:
(800) 221-5743 • (212) 239-7765 • FAX: (800) 947-2215 • (212) 239-7549

RAXXESS

CONFIG-U-RAXX

Center Desks

Center Desks are the "centerpiece" of your Config-U-Raxx system. They are available in maple or ebony fleck with silver trim and are height adjustable from 26"-30" for use with 12U or 14U Side Wings (sold separately). Start by choosing the center desk that best suits your needs.

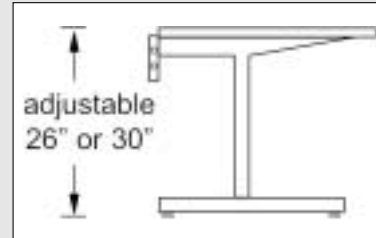

SCD-36
Straight Center Desk- small



SCD-36B Straight Center Desk- small-ebony.....**269.95**
SCD-36M Straight Center Desk- small-maple.....**269.95**

SCD-42B
Straight Center Desk- Large



SCD-42B Straight Center Desk- large-ebony.....**289.95**
SCD-42M Straight Center Desk- large-maple.....**289.95**

ACD-30-45B and ACD-42-56B
Angled Center Desks



ACD-30-45B Angled Center Desk- small-ebony**279.95**
ACD-30-45M Angled Center Desk- small-maple**279.95**
ACD-42-56B Angled Center Desk- large-ebony**335.95**
ACD-42-56M Angled Center Desk- large-maple.....**335.95**

CRND Corner Desks



CRND-B Corner Desk-ebony**349.95**
CRND-M Corner Desk-maple.....**349.95**

RAXXESS

CONFIG-U-RAXX

Side Wings

SSW-22

Available as 14U rack with melamine sides in ebony fleck or maple, 14U steel sides with silver hammertone finish and 12U steel sides with silver hammertone finish. 1/8" thick melamine top surface available in ebony fleck or maple with silver trim. Doors and shelves are sold separately.

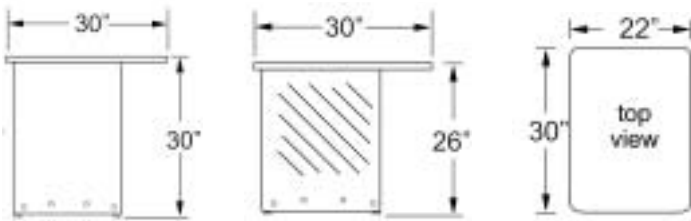

- SSW-22B Straight Side Wing- wood sides-ebony-14U**165.95**
- SSW-22M Straight Side Wing- wood sides-maple-14U**165.95**
- SSW-22-12BS Straight Side Wing- metal sides-ebony-steel-12U ..**179.95**
- SSW-22-12MS Straight Side Wing- metal sides-maple-steel-12U ..**179.95**
- SSW-22BS Straight Side Wing- metal sides-ebony-steel-14U**195.95**
- SSW-22MS Straight Side Wing- metal sides-maple-steel-14U**195.95**

STUDIO ACCESSORIES

1418

Angled Side Wings

ASW-20-29

Angled side wings bring your rackmounted equipment closer to your sitting position. Available as 14U rack with melamine sides in ebony fleck or maple, 14U steel sides with silver hammertone finish and 12U steel sides with silver hammertone finish. 1/8" thick melamine top surface available in ebony fleck or maple with silver trim. Doors and shelves are sold separately. You must specify right or left-hand side when ordering.

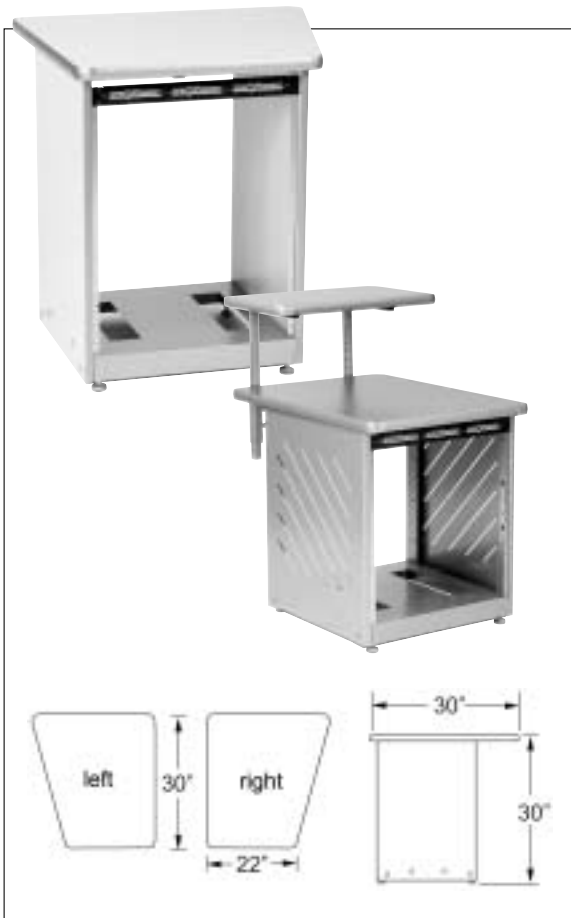

- ASW-20-29LB Angled Side Wing- left-wood sides-ebony-14U**209.95**
- ASW-20-29LM Angled Side Wing- left-wood sides-maple-14U**209.95**
- ASW-20-29/12LBS Angled Side Wing- left-metal sides-ebony-steel-12U**229.95**
- ASW-20-29/12LMS Angled Side Wing- left-metal sides-maple-steel-12U**229.95**
- ASW-20-29LBS Angled Side Wing- left-metal sides-ebony-steel-14U**244.95**
- ASW-20-29LMS Angled Side Wing- left-metal sides-maple-steel-14U**244.95**
- ASW-20-29RB Angled Side Wing- right-wood sides-ebony-14U**209.95**
- ASW-20-29RM Angled Side Wing- right-wood sides-maple-14U**209.95**
- ASW-20-29/12RBS Angled Side Wing- right-metal sides-ebony-steel-12U**229.95**
- ASW-20-29/12RMS Angled Side Wing- right-metal sides-maple-steel-12U**229.95**
- ASW-20-29RBS Angled Side Wing- right-metal sides-ebony-steel-14U**244.95**
- ASW-20-29RMS Angled Side Wing- right-metal sides-maple-steel-14U**244.95**



EQUIPMENT LEASING AVAILABLE

RAXXESS

CONFIG-U-RAXX

STUDIO ACCESSORIES

1419

Shelves

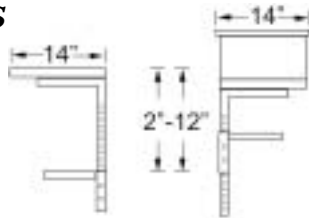
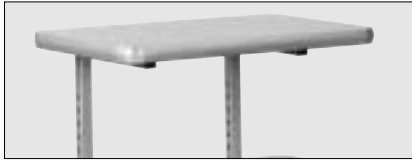

Shelf/rack height is adjustable from 2" to 12" above your desktop.

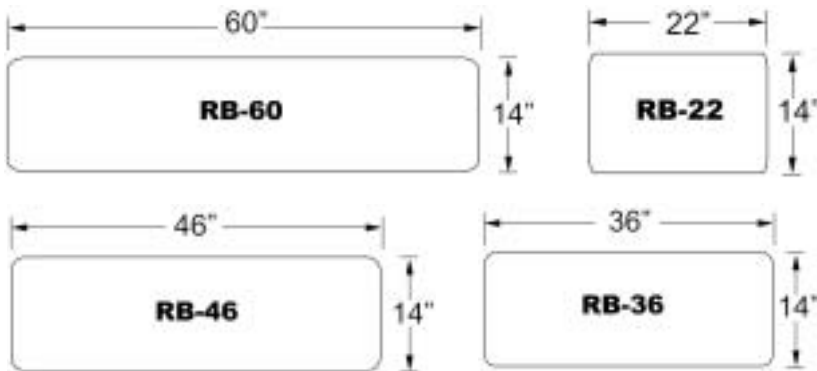

- RB-60B** Upper shelf for center desks- extra large-ebony.....**139.95**
- RB-60M** Upper shelf for center desks- extra large-maple.....**139.95**
- RB-46B** Upper shelf for center desks- large-ebony.....**119.95**
- RB-46M** Upper shelf for center desks- large-maple.....**119.95**
- RB-36B** Upper shelf for center desks-small-ebony.....**99.95**
- RB-36M** Upper shelf for center desks-small-maple.....**99.95**
- RB-22B** Upper shelf for side wings- incl. hardware-ebony.....**84.95**
- RB-22M** Upper shelf for side wings- incl. hardware-maple.....**84.95**



UCR Under Counter 10 Space Rack with CP Shelf

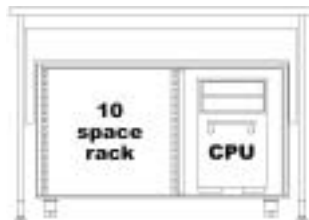

UCR shown with SCD-42 (optional)

KBS1 Keyboard Shelf and KBS-2 Keyboard/Mouse Shelf



With the 3-D adjustable shelf, you can put your keyboard exactly where you want it! This shelf slides forward and back, up and down, tilts up and down and swivels left to right. Available in ebony fleck or maple.

- KBS-1B** Ebony 20" keyboard shelf for CRND only.....**99.95**
- KBS-1M** Maple 20" keyboard shelf for CRND only.....**99.95**
- KBS-2B** Ebony 28" keyboard shelf for ACD and SCD only.....**104.95**
- KBS-2M** Maple 28" keyboard shelf for ACD and SCD only-maple.....**104.95**

SFRK-4B

4U rack for use in place of RB-22 allowing quick access to most commonly accessed equipment.

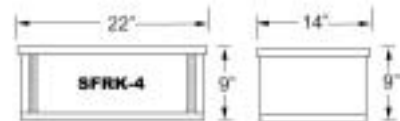

SFD Studio Furniture Door

Steel framed Plexi door for SSW and ASW Side Wings (wood sides only)- silver hammertone.



RAXXESS

CONFIG-U-RAXX

SUGGESTED CONFIGURATIONS

STUDIO ACCESSORIES

1420

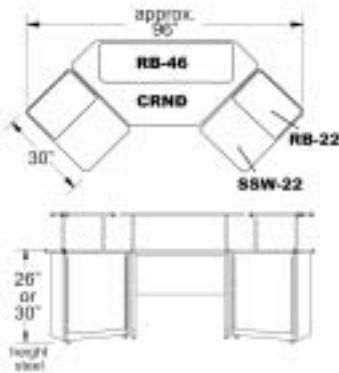

- 1 - CRND-B corner desk
- 2 - SSW-22B side wing racks
- 1 - RB-46B rack bridge
- 2 - RB-22B rack bridges

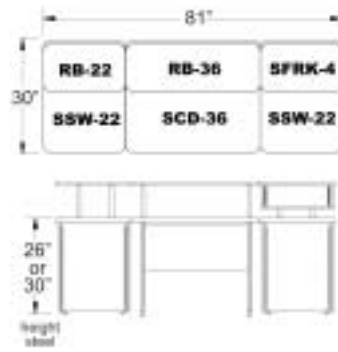

- 1 - SCD-36B
- 2 - SSW-22/12BS side wing racks
- 1 - RB-36B rack bridge
- 1 - RB-22B rack bridge
- 1 - SFRK-4B
- 1 - CBS center bridge support



- 1 - SCD-36M center desk
- 2 - SSW-22M side wing racks
- 1 - RB-60M rack bridge

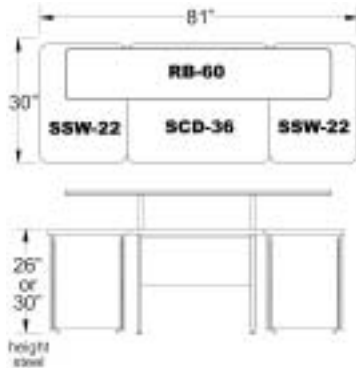

- 1 - ACD-42-56M center desk
- 2 - ASW-20-29M side wing racks
- 1 - RB-46M rack bridge
- 2 - RB-22M rack bridges
- 1 - KBS-2M

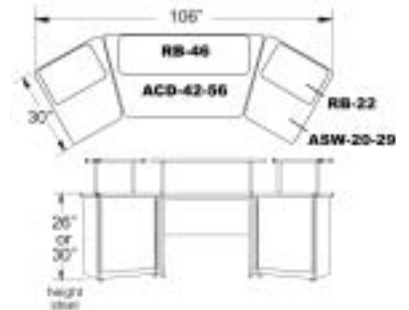

RAXXESS

STUDIO FURNITURE

ETUDE

Perfect as a studio keyboard workstation or learning center, the Etude's side supports are constructed of 1" by 2" 16-gauge tubular steel. The fabricated bottom cross member is 1 1/2" by 6". The generous 55" wide and 16" deep keyboard shelf supports an 88-note keyboard. The contoured upper shelf, which also measures 55 x 16", can easily accommodate audio and video monitors. A computer keyboard shelf can be mounted to either of the two standard shelves using the hardware provided into pre-drilled holes. Both the keyboard shelf and the optional printer/CPU shelf (not shown) that mounts to the lower portion of the frame are adjustable in 1" increments up to 5"

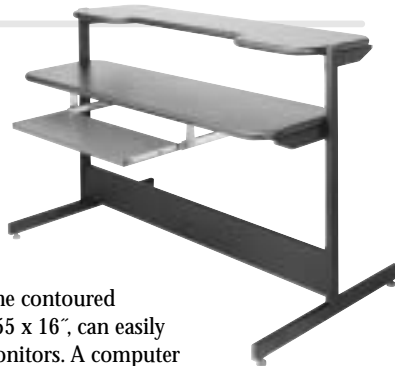

419.95

Etude Printer/CPU Shelf (ETUDEPS)99.95

RMPC-4ATX Computer Chassis

- ◆ 4 space chassis fits any ATX style motherboard
- ◆ 20.3" deep with 2" removable handles
- ◆ Supplied with a 300w ATX power supply

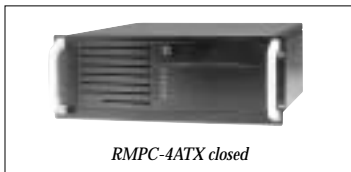

RMPC-4ATX closed

7 Expansion Slots with Card Braces:

- ◆ Includes 2 internal and 1 external 3.5" drive bays, plus 3 external 5.25" bays

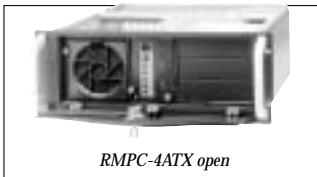

RMPC-4ATX open

Front Panel Features:

- ◆ Switches for power, reset and alarm
- ◆ Power and drive activity LED indicators
- ◆ Alarms for fan and temperature
- ◆ Hinged locking plate for security
- ◆ AT style "plug and play" keyboard connector
- ◆ 4.5" filtered intake fan keeps components cool and dust-free.

RMPC-4ATX \$199.95

ISORAXX

Recent developments in recording technology allow today's audio professionals and enthusiasts unprecedented control over the quality of their work. But along with the benefits provided by these great new products comes additional noise created by fans and hard disk drives. The IsoRaxx is the solution to mechanical noise problems in your studio.



- ◆ Keeps equipment safe and quiet — reduces fan and hard drive noise by an average of 21dB
- ◆ Electrostatic filter intake keeps dust out
- ◆ Equipment is easily visible through the clear lexan panel in the front door
- ◆ Separate passages for signal, AC and computer cables
- ◆ Dual variable-speed fans
- ◆ Key-lockable rear door with removeable hinges ease equipment installation and maintenance
- ◆ Constructed of 3/4" thermally fused melamine
- ◆ Comes assembled; they are available in ebony fleck or maple finishes; casters included

	ISR-14-24	ISR-14-30	ISR-20-30
Rack Spaces	14	14	20
Overall Height	31.75"	31.75"	42.5"
Overall Width	25"	25"	25"
Desktop Depth	25.5"	32"	32"
Upper Rack Depth	15.75"	26.25"	26.25"
Middle Rack Depth	17.75"		
Lower Rack Depth	21"	22"	22"
Total Rack Depth w/door	23.625"	30"	30"
Price	\$909.95	\$979.95	\$1119.95

STUDIO ACCESSORIES

1421

OPTIONAL ACCESSORIES

SFD Studio Furniture Rack Door – For the Lonestar, Golden Gate, Big Apple and Big Easy. Features matching ebony fleck melamine with solid oak trim, a clear lexan door and flush mount hinge system. Keylock included. Can be set for left or right swing and will retrofit to existing furniture systems.....**119.95**



SFD

ERK-4 Four-space elite rack, sits flush on all shelves**104.95**

CBS Center bridge support for heavier loads**39.95**

KBS-1 28" Keyboard & Mouse Shelf For all workstations. Finished in matching ebony fleck while the front edge is trimmed in solid oak**99.95**



ERK-4

Studio Furniture Casters
Fits all workstations except the Daytona**31.95**

RAXXESS

STORAGE/SHELVES

UTS Utility Shelves

16-gauge, cold rolled steel shelves that allow the rackmounting of otherwise non-rackmountable equipment. One-piece construction. Finished in durable black baked enamel.



- UTS-1 11" x 1.75" (DxW). 1 space**27.95**
- UTS-2 14.50" x 3.50" (DxW). 2 space**35.95**
- UTS-3 14.50" x 5.25" (DxW). 3 space**39.95**

UNS Universal Rack Shelf

One space, 14-gauge shelf has a hole-pattern in the bottom for mounting a variety of half-rack equipment. Comes with two each 6/32, 8/32, and 10/32 machine screws. 10 x 1.75" (DxW). Finished in durable black baked enamel.....**18.95**

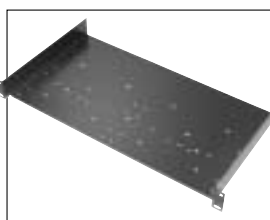

SLE Economy Sliding Shelf

Supports equipment up to 35 lbs. Ears attached to the rear frame allow the unit to be secured to the back of any enclosed rack. 12" sliders with nylon roller bearings allow a smooth sliding movement. Sliders provide positive lockout, for the black laminated wood shelf**51.95**



SLS Sliding Shelf

Extra heavy duty shelf occupies just one rack space. Supports up to 100 lbs. with a safety factor of 100% if properly secured. The 14 gauge steel shelf is finished in black baked enamel. Extra heavy-duty ball bearing sliders extend a full 14" for a usable surface area of 16 x 14" (WxD), and

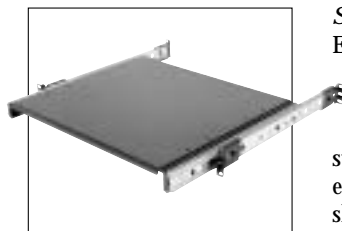

are equipped with a mechanism that locks the shelf in the out position. Rear rack rail provided.....**125.95**

SLS 1.5 Sliding Shelf

Steel shelf measuring 17.50 x 14.5" (WxD) locks both in and out. Extending on 14", full extension, ball bearing sliders and occupying one and a half rack spaces. Supported by an all steel frame and extension ears for rear support.....**97.95**

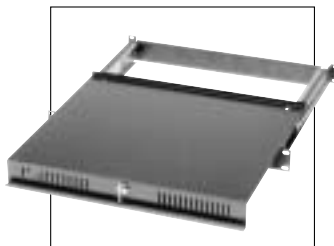

TR Trap Shelf

Constructed of 16-gauge cold, rolled steel, it is finished in durable black baked enamel. Comes complete with 2 fully adjustable hold down bars that "trap" equipment. Bars are padded to protect the finish on your gear. Returns on the front and rear edges of shelf provide additional lateral strength.

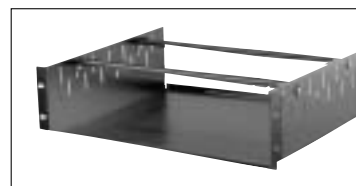

- TR-2 14.25 x 17.25 x 3.50" (DxWxH). 2 space trap**38.95**
- TR-3 14.25 x 17.25 x 5.25" (DxWxH). 3 space trap**44.95**
- TR-4 14.25 x 17.25 x 7" (DxWxH). 4 space trap**48.95**

UTVS-3 Vented Shelf

A 16-gauge steel shelf that is finished in black powder coat, handles up to 60 lbs. of equipment and occupies 3 rack spaces. Slotted bottom allows for ventilation and the slotted rear return allows for cable management.

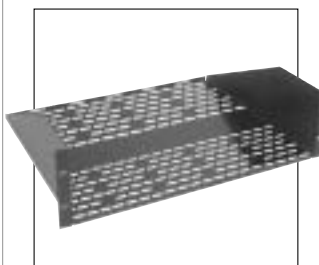

- UTVS-3-14 3 space, 14" deep**38.95**
- UTVS-3-18 3 space, 18" deep**42.95**

ADS-3 Adjustable Shelf

This three space, 16-gauge steel shelf has three position adjustable ears that allows you to move equipment from flush with rack rail to 8" forward of rail. Its dimensions are 19 x 17 x 5.25" (WxDxH)**44.95**

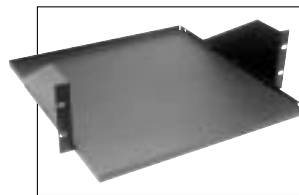

VCS-2 Cantilvered Shelf

Occupying two rack spaces, this 16-gauge steel shelf allows you to bring equipment well forward of the rack face. Vented for air circulation, this shelf is 18" deep and will support up to 50 lbs. It features built-in cable management and is finished in black

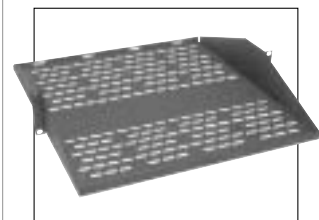

powder coat**45.95**

WMS Wall-Mount Shelf

Provides a secure, yet inexpensive way to mount non-rack mountable equipment to a wall. With a vented bottom for air circulation and conduit knock-outs for cable passage, this 16-gauge steel, fully welded unit has a 200 pound capacity. Finished in rugged black powder coat, it can also be used to house the ER or ERK series of racks.....**64.95**

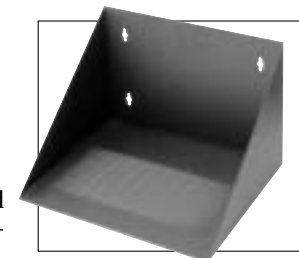

RAXXESS

STORAGE/SHELVES

ESD - Economy Sliding Drawer

16-gauge steel, fully enclosed construction with a black semi-gloss finish. The 12" cabinet grade slides allow for full extension. The rackmount drawers feature a laser cut knockout on the front panel for adding an optional key lock, as well as a laser cut knockout in the rear for cable passage if needed.

ESD-2 2 space.....**79.95** **ESD-3** 3 space.....**81.95**
ESD-4 4 space.....**89.95**

SDR - Sliding Rack Drawer

Heavy duty sliding rack drawer available in 2, 3 or 4 spaces. Cabinet grade 14" full extension sliders provide smooth action. Features include a large flush mount latch, a 13 gauge drawer front and black textured enamel finish. A laser cut knockout on the front panel allows you to add an optional lock, while the laser cut knockout in the rear allows cable passage should you want to store an electronic device in the drawer.

SDR-2 2 space.....**90.95** **SDR-3** 3 space.....**100.95**
SDR-4 4 space.....**111.95**

Lock for ESD and SDR Drawers

The ESD and SDR feature laser cut knockouts on the front panel for adding a key lock at any time. (LOCK).....**9.95**

PB - Project Box

These project boxes are of two piece, cold rolled steel construction. Perfect for the do-it-yourselfer. Black baked enamel finish. Available in one or two space configuration. Front to back measures 6".

PB-1 1 space.....**29.95** **PB-2** 2 space.....**32.95**

RKV - Rack Vault

Secured storage of otherwise loose equipment, tools, tapes, CD's, papers and other personal items; all steel construction; flush mount latch and keyed lock. Perfect for any audio rack, in the studio, on the road or at the installation; black baked enamel finish.

RKV-3 3 spaces. 17 x 9 x 5" (LWH).....**51.95**
RKV-4 4 spaces. 17 x 9 x 7" (LWH).....**58.95**

Mounting Bracket for Fostex 6301B Speakers

A kit for rackmounting a pair of the Fostex 6301B speakers. Finished in black powder coat.....**83.95**

Media Holders

Convenient way to store compact discs, DAT tapes, or audio cassettes in you rack.

RDT 3 space. Holds 27 DAT tapes.....**49.95**
RCH 3 space. Holds 20 cassettes.....**51.95**
RCD 4 space. Holds 40 CDs.....**58.95**

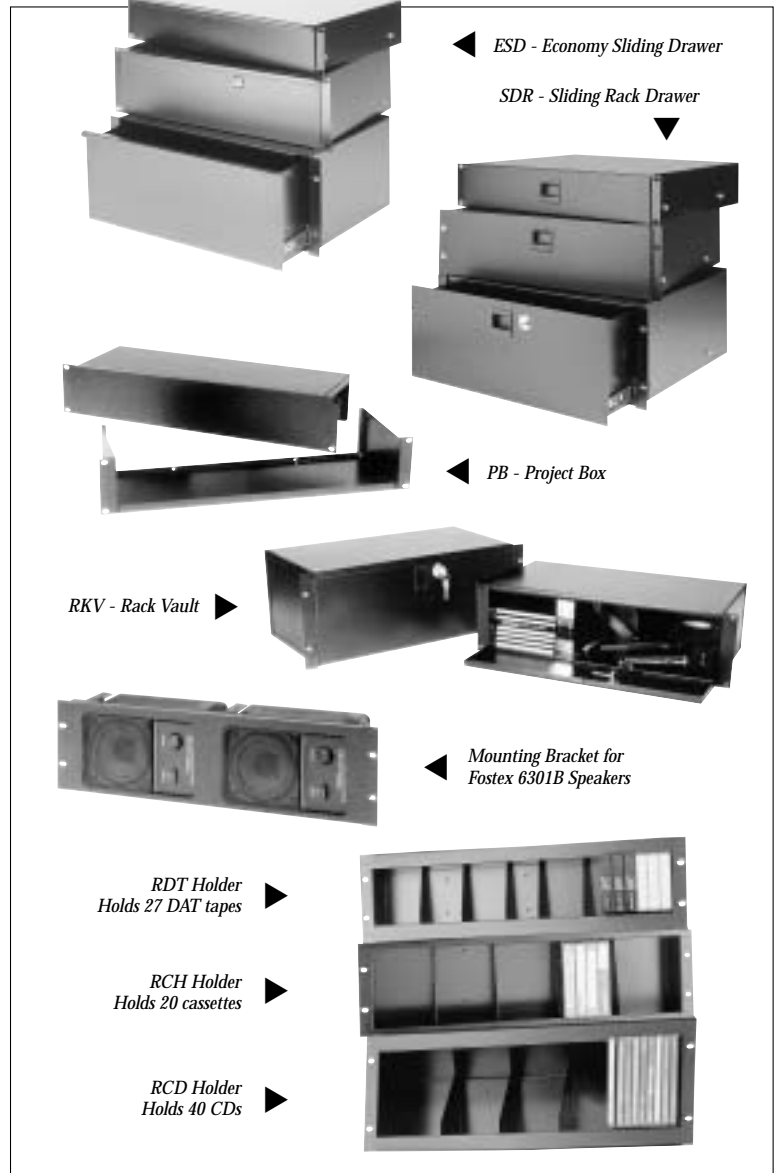

Custom Mounting Kits for Consumer A/V Components



An easy and attractive solution for rack mounting non-rackmountable components. Perfect for custom home installations, office suites or any other location where aesthetics are as important as sound. These kits will give your installation the "custom" look that clients love.

Each kit includes the aluminum faceplate with anodized or textured paint finish, cold rolled steel rack shelf, and rear braces that prevent shifting. Optional clamping bars are available when maximum stability is required. Call today for more information.

RAXXESS

HARDWARE AND ACCESSORIES

STUDIO ACCESSORIES

1424

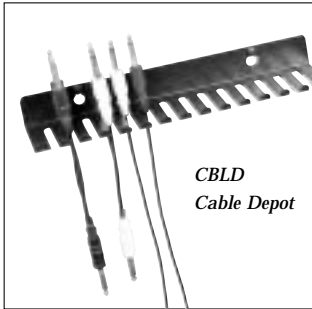

CBLD
Cable Depot

Cable Depot (CBLD)

16-gauge steel cable reorganizer keeps cabling off the floor, out of the way and kink-free. Fourteen fingers extend to hold up to forty cables. Maximum cable diameter is .25".....**11.95**

Headphone Hangers

A convenient way to hang headphones. The HH-1 comes straight out of the rack while the HH-2 projects out at a right angle, taking the place of any rack screw already in your rack. Simply screw it in until it is in the desired position and tighten the nut.

HH-1 Straight headphone hanger.....**6.95**

HH-2 Right angle headphone hanger.....**6.95**



HH-2



RB-UTS

Button Mount Utility Shelf (RB-UTS)

16 gauge cold rolled steel utility shelf that mounts easily to rack buttons and removes just as easily. Flat black powder coat finish.....**28.95**

Button Mount Tool Rack (RB-TC)

Convenient way to keep tools at hand when working on rack or gear. 16 gauge cold rolled steel tool rack mounts conveniently to buttons. Finished in black texture powder coat finish.....**27.95**



RB-TC

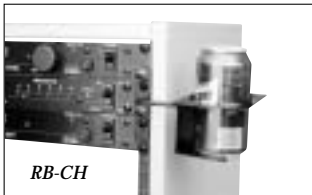

RB-CH

Button Mount Cup Holder (RB-CH)

Keep your drink close at hand. 16 gauge cold rolled steel with black textured finish.....**19.95**

Button Mount Guitar Holder (RB-GH)

Button mount guitar holder keeps your guitar where you need it when not being played. Padded to eliminate marring the finish. Removes easily and stores in small spaces.....**17.95**

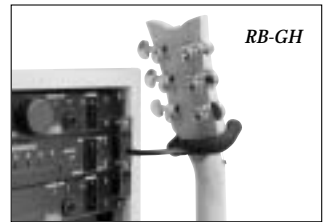

RB-GH



AR-5

Console Lamp with BNC Connector (CL-1H)

A high-powered 12 volt, hooded mixing console lamp that illuminates the mixer and enhances isolation in low light environments. 12" sturdy goose neck, BNC connector, and black matte finish.....**17.95**

Accessory Riser (AR-5)

A handy little device that mounts under an amplifier handle or on a mic stand. It can act as a third hand or save valuable rack space. Perfect for tuners or other small devices. 3 x 5 x 5" (HxDxW).....**11.95**



CL-1H

RACK RAILS

RKRL - Rack Rail

11-gauge steel full hole rack rail; punched and tapped for 10-32" screws. Side mounting holes punched every space. Available in all sizes, 2 to 45 space, black baked enamel. Sold in pairs.

GKRL - Galvanized Rack Rail

.075" galvanized steel rack rail; punched and tapped for 10-32" screws; full hole rack rail has holes tapped at 5/8" - 5/8" - 1/2". Available in any length up to 45 space. Sold in pairs.

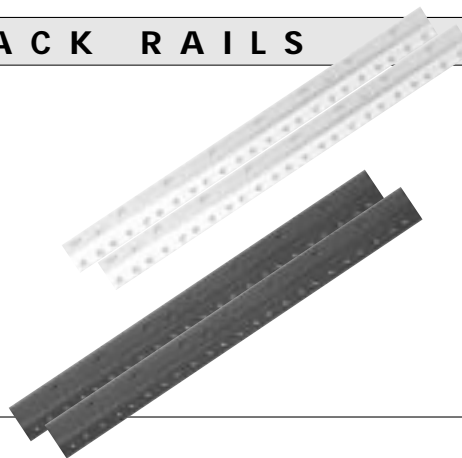

RKRL
Rack Rail
\$1.35 per space

GKRL
Galvanized Rack Rail
.90 per space

Available up to 45 spaces



ONE HOUR FREE PARKING

AT 349 W. 34th STREET (with purchase of \$100 or more)

HARDWARE AND ACCESSORIES

Pin Torx Security Screws

10-32 x .75" black oxide pin torx pan head.
When security is vital.
PNTX-50 50 per bag.....**12.95**
PNTX-100 100 per bag.....**19.95**

Pin Torx Bit (PNTX-B)

Matching bit for pin torx screws.....**7.95**

Pan Head/Captive (CPSW)

10-32 x .75" philips pan head screws integrated with nylon cup washers save the user the trouble of fumbling with separate parts allowing for faster installation of equipment.
CPSW100 With washers. 100 quantity..**14.95**

CPSW500



CPSW500 With washers. 500 quantity.
Includes fanny pack.....**69.95**

Square Drive Screws (SDS)

When security is a concern. Pan head 10-32 x .75" long. 100 per bag with washers ...**19.95**

Square Drive Bit (SDB)

Accommodates security rack screws.....**2.00**

Shoulder Washers (SHW)

#10 washers sold in bags of 100. Used to isolate equipment from rack rail to eliminate ground loop problems.....**6.35**

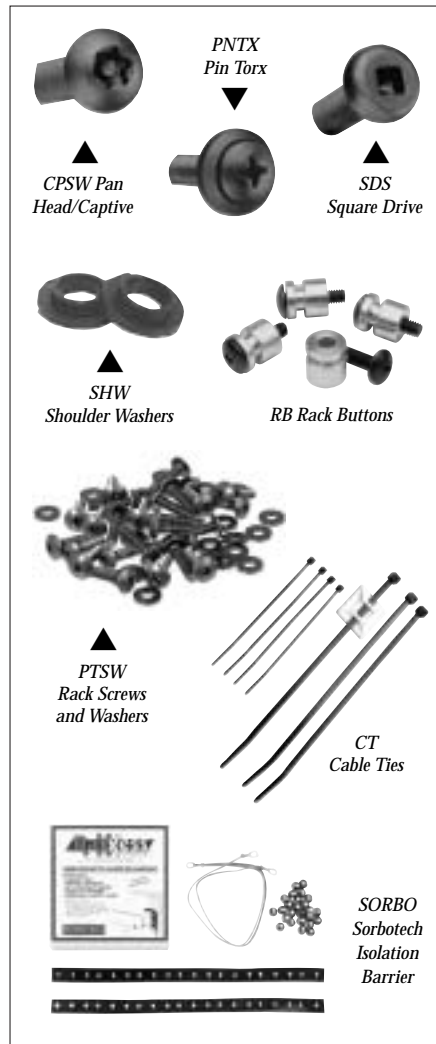

Rack Buttons (RB)

Machined aluminum cylinders with center through hole to accept 10-32 rack screw. Buttons can be mounted to rack rail without equipment interference and can hold a variety of accessories. Sold in pairs. 1/2" long.....**6.35**

Rack Screws and Washers (PTSW)

10-32 x .75" black oxide, phillips truss head screws with #10 nylon washers to prevent scratching equipment. Available in packages of 25, 50 and 100.
PTSW25 25 peices.....**4.75**
PTSW50 50 peices.....**7.95**
PTSW100 100 peices.....**14.95**



CT Cable Ties

100 pieces per bag. Black color.
CT-100-4 4" cable ties.....**7.95**
CT-100-8 8" cable ties.....**9.69**
CT-100-8R 8" reusable cable ties.....**13.49**
CT-100-12 12" cable ties.....**14.25**
CTM Cable tie mount; 1/5 x 1/5".....**11.95**

Sorbotech Isolation Barrier (SORBO)

Vibro acoustic damping barrier for six rack spaces of gear, a proven shock absorber and electrical isolator. Kit includes rack rail barrier, shoulder washers and copper braided grounding strip.....**Call**

Rack Mount Power Distribution

The PD-800 is an attractive, high-quality and economical rack mount power distribution solution. The PD-800L features pullout lights with an on/off switch and dimmer control. Both the PD-800L and the PD-800 feature a heavy-duty 12' AC cable and 9 unevenly placed outlets, so you don't have to give up an extra outlet each time you plug in a wall-wart.

- ◆ Long (12'), 14-gauge AC cord
- ◆ Nine unevenly spaced outlets conveniently accept wall warts
- ◆ Front mounted circuit breaker
- ◆ Spike and surge protection
- ◆ 15 amp rating ◆ ETL approved
- ◆ RFI and EMI surge protection on both sides of the power line
- ◆ 14-gauge cold rolled steel faceplate with durable powder coat finish

PD-800 Rack Mount Power Distribution.....**51.95**

PD-800L Rack Mount Power Distribution with pullout lights, on/off switch and dimmer control.....**84.95**



RAXXESS

POWER DISTRIBUTION

SC-6 - Low-Voltage Sequencing Controller



Allows remote sequencing of up to six AC circuits. Using standard CAT-5 cable or terminal strips (12 or 24V), the user can send relay control messages to our PM series power modules. Jumper switches inside each module allow you to assign a circuit value to each module. A trim-pot on the SC-6 allows you to adjust the power on/power off delay time. Four SC-6 units can work in parallel or series. This will allow you to daisy chain multiple sets of sequenced circuits for a cascading array of delayed power-on circuits.

The PM-1 modules are available in both Modular Power Strip and stand-alone versions with your choice of CAT-5 or terminal strip connectors.

A wall-mounted remote on/off switch (SC-6RS) is available for remote activation of the SC-6.

- ◆ UL listed power supply
- ◆ Connects to other Raxxess power sequencing products CAT-5 cable
- ◆ Up to four units may be connected, allowing up to 24 sequence steps
- ◆ 24VDC terminal strips provide to interface with existing power products
- ◆ Dry-contact closure terminals for remote power sequencing

- SC-6 Low Voltage Sequencing Controller**349.95**
- SC-6RS Wall switch for SC-6/SPD-6 remote control**45.95**
- SC-6RSK Key switch for SC-6/SPD-6 remote control.....**51.95**

STAND-ALONE, SURFACE MOUNT REMOTE POWER MODULES

Model	CAT-5	Terminal Strip		Price
PM-1SRJ-DR15	✓		DR-15	147.95
PM-1SRJ-DR20	✓		DR-20	153.95
PM-1SRJ-DRIG	✓		Isolated Ground	181.95
PM-1SRJ-DRHG	✓		Hospital Grade	167.95
PM-1SRJ-L5	✓		L5-30	173.95
PM-1SRJ-TT	✓		TT-30	159.95
PM-1STS12-DR15		12v	DR-15	147.95
PM-1STS12-DR20		12v	DR-20	153.95
PM-1STS12-DRIG		12v	Isolated Ground	181.95
PM-1STS12-DRHG		12v	Hospital Grade	167.95
PM-1STS12-L5		12v	L5-30	173.95
PM-1STS12-TT		12v	TT-30	159.95
PM-1STS24-DR15		24v	DR-15	148.95
PM-1STS24-DR20		24v	DR-20	153.95
PM-1STS24-DRIG		24v	Isolated Ground	181.95
PM-1STS24-DRHG		24v	Hospital Grade	167.95
PM-1STS24-L5		24v	L5-30	173.95
PM-1STS24-TT		24v	TT-30	159.95

MPS - Modular Power Strip

Available in just about any configuration to meet any power distribution/ sequencing needs. The MPS Modular Power Strips can be ordered in an almost infinite variety of configurations; including current levels, receptacle type, remote sequencing modules, color-coded pig tails, etc.

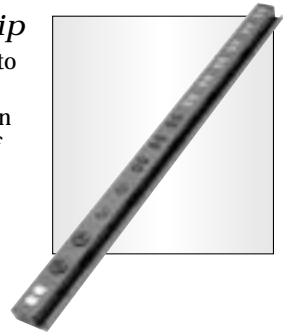

- ◆ 32.5" (7 devices) or 64" (14 devices)
- ◆ 1 to 6 individual circuits
- ◆ Mounting plates for 1, 2, 3, 4 or 6 devices
- ◆ Choice of receptacles - Edison 15 or 20 amps, TT-30, L5-30, Isolated Ground, IEC 320, Hospital Grade
- ◆ 20 and 30 amp sequencing power modules available for MPS with TT-30, L5-30 and duplex receptacles.

- MPS-32 32" Holds 7 receptacles.....**Call**
- MPS-64 64" Holds 14 receptacles.....**Call**

LPPS - Low Profile Power Strip

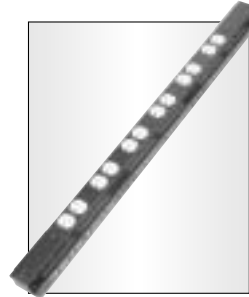

Available in three sizes with 6, 9, or 12 Edison duplex receptacles in your choice of 15 or 20 amp versions. Up to 3 independent circuits.

- ◆ Three lengths available - 34" (6 duplex Edison), 46.5" (9 Duplex Edison) or 59" (12 duplex Edison)
- ◆ 1 circuit standard - 2 or 3 optional
- ◆ Available in 15 or 20 amp versions

Model	Duplex	Amp	Circuit	Termination	Price
LPPS6-15-1	6	15	1	Cord	90.95
LPPS6-15-2	6	15	2	Pigtails	99.95
LPPS6-15-3	6	15	3	Pigtails	104.95
LPPS6-20-1	6	20	1	Cord	111.95
LPPS6-20-2	6	20	2	Pigtails	118.95
LPPS6-20-3	6	20	3	Pigtails	125.95
LPPS9-15-1	9	15	1	Cord	111.95
LPPS9-15-2	9	15	2	Pigtails	118.95
LPPS9-15-3	9	15	3	Pigtails	125.95
LPPS9-20-1	9	20	1	Cord	139.95
LPPS9-20-2	9	20	2	Pigtails	146.95
LPPS9-20-3	9	20	3	Pigtails	153.95
LPPS12-15-1	12	15	1	Cord	132.95
LPPS12-15-2	12	15	2	Pigtails	139.95
LPPS12-15-3	12	15	3	Pigtails	149.95
LPPS12-20-1	12	20	1	Cord	159.95
LPPS12-20-2	12	20	2	Pigtails	167.95
LPPS12-20-3	12	20	3	Pigtails	174.95



For Any Inquiries Regarding Your Order, Call Our Customer Service:
(800) 221-5743 • (212) 239-7765 • FAX: (800) 947-2215 • (212) 239-7549

RAXXESS

CONVERTA RACKS

Converta Racks

Maximizes rack storage in a minimum of vertical space. Ideal for the DJ or musician who wants to get on and off the job as fast as he can.

- ◆ Removable top cover exposes 10 or 12 rack spaces that can be tilted to any of 8 positions from zero to 45° ◆ Available with 6 or 10 vertical rack spaces
- ◆ Removable rear cover provides easy access for connecting cables
- ◆ Rugged plywood construction ◆ Internally braced
- ◆ Heavy-duty butterfly latches, releasable hinges and nickel-plated corners
- ◆ Rugged, gray carpeted exterior

Also Available — Recessed Converta Racks

Includes recessed spring-loaded handles and latches, black carpet covering and heavy-duty metal corners.

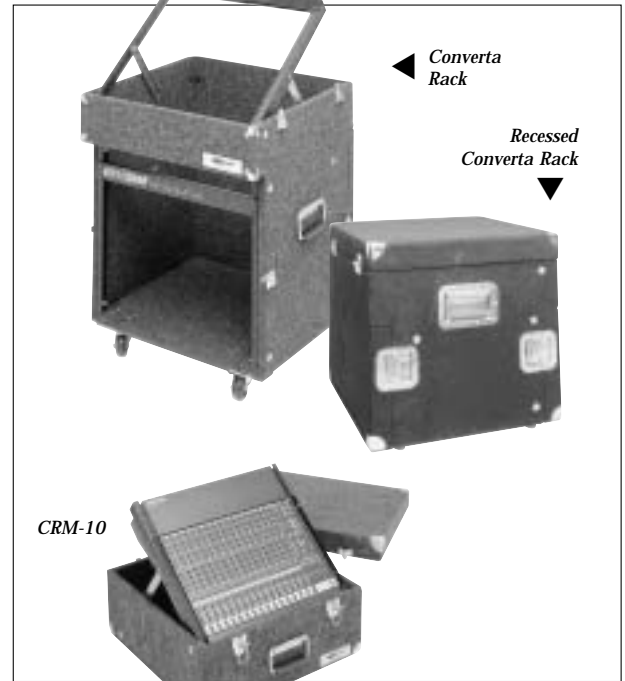

CRM-10

CASTER-4

Set of 4 casters for the CR-10/10 and CR-12/10.....**38.95**

CASTER-4LCK

Set of 4 casters with brakes for the CR-10/10 and CR-12/10 ..**45.95**

	CRM-10	CR-10/6	CR-10/10	CR-12/10
Lower Rack Spaces	N/A	6	10	10
Top Rack Spaces	10	10	10	12
Overall Width	20.75"	20.625"	20.625"	20.625"
Lower Rack Depth	N/A	16.125"	16.125"	19.25"
Height of space between top mixer and lower rack	7.25"	5"	5"	5"
Depth of top lid	2.5"	2.5"	2.5"	2.5"
Overall Depth	20.75"	20.125"	20.125"	23.25"
Overall Height	9.75"	18.75"	26"	26"
Price	181.95	230.95	258.95	293.95
Recessed Hardware Version Price	—	CR-10/6R 293.95	CR-10/10R 328.95	CR-12/10R 363.95

STUDIO ACCESSORIES

1427

Elite Converta Racks

The functionality of Converta Racks in a semi-portable furniture style cabinet. Perfect for houses of worship, schools, corporate meeting rooms or any venue where A/V equipment must suit the decor.

- ◆ 10 or 16 vertical rack spaces in the lower section
- ◆ 10 rack spaces on top anchored by a ratchet system that can be tilted to any of 8 positions from zero to 45° ◆ Constructed of 3/4" fused melamine
- ◆ Locking, smoked lexan front door provides security and visibility
- ◆ Heavy-duty key-lockable panel covers the mixer section, retracts on sturdy cabinet sliders and lays flat against the rear of the rack
- ◆ Locking rear door with breakaway hinges allows easy equipment installation and maintenance ◆ Includes furniture-grade hooded casters
- ◆ Passages in the bottom of the rack allow for easy cable management
- ◆ All hardware is brass plated to compliment the cherry finish
- ◆ Ships assembled via common carrier only



	Vertical Rack Spaces	Overall Height	Outside Depth	Outside Width	Inside Depth from Rack Rails	Weight	Price
ECR-10/10 CH	10	31"	24"	20.75"	21	100 lbs.	384.95
ECR-10/16 CH	16	41"	24"	20.75"	21	120 lbs.	419.95

RAXXESS

COMMERCIAL PRODUCTS

Gangable Audio Rack (GAR)

- ◆ Fully welded gangable rack, constructed of 12-gauge (top and bottom) and 14-gauge (side posts) cold rolled steel
- ◆ Available in 2 depths, for equipment 22.50" and 27.50" deep
- ◆ Adjustable 11-gauge steel rack rails, in both front and rear positions
- ◆ Punched rack rail supports with multiple cable tie offs
- ◆ Vertical cable passageways
- ◆ 3 sizes of conduit knockouts in three locations, including the solid roof insert
- ◆ Slotted vents at the front frame top
- ◆ Durable black powder coat
- ◆ Optional locking side panels easily mount via tabs that fit into slots in the frame
- ◆ Optional front and rear locking doors for left or right swing, plus perforated solid and fan roof inserts are available.



Model	Panel Space	Depth	Width	Height	Height w/Casters	Price
GAR-35-26	35 space (61 1/4")	26"	24"	67.75"	69"	609.95
GAR-35-32	35 space (61 1/4")	32"	24"	67.75"	69"	629.95
GAR-40-26	40 space (70")	26"	24"	76.25"	77.5"	643.95
GAR-40-32	40 space (70")	32"	24"	76.25"	77.5"	664.95
GAR-44-26	44 space (77")	26"	24"	83.25"	84.5"	108.95
GAR-44-32	44 space (77")	32"	24"	83.25"	84.5"	119.95

Side Panels

16-gauge steel side panels, finished in textured powder coat. Available for the GAR and SKR series racks. Elite side panels of ebony fleck laminated hardboard with solid oak edges are also available for the SKR series.



For the SKR Series

Model	Finish	Spaces	Price
SKRSP-12	powdered coat	12 spaces	35.95
SKRSP-24	powdered coat	24 spaces	58.95
SKRSP-42	powdered coat	24 spaces	94.95
SKRESP-12	ebony fleck	12 spaces	46.95
SKRESP-24	ebony fleck	24 spaces	78.95
SKRESP-42	ebony fleck	42 spaces	118.95

For the GAR Series

Model	Finish	Spaces	Price
GARSP-35-26	powdered coat	35 spaces	124.95
GARSP-35-32	powdered coat	35 spaces	149.95
GARSP-40-26	powdered coat	40 spaces	129.95
GARSP-40-32	powdered coat	40 spaces	164.95
GARSP-44-26	powdered coat	44 spaces	144.95
GARSP-44-32	powdered coat	44 spaces	174.95

Roof Inserts for GAR Racks

Optional roof inserts for various service applications. All are of 16-gauge cold rolled steel and are finished in a durable black powder coat finish.

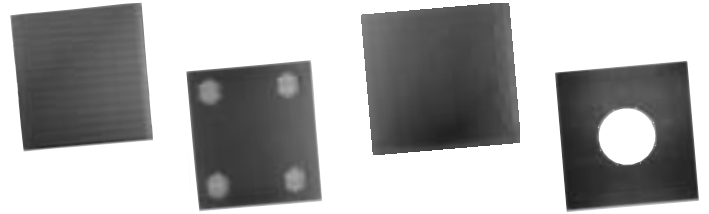

GART-10F Houses one 10" fan	51.95
GART-4.5F Mounts four 4 1/2" fans	51.95
GART-P 66% open area perf pattern	51.95
GART-S Solid roof insert	51.95

Cool off the gear in your GAR series racks with these ultra quiet, easy-to-mount 115 volt fan kits. They include unterminated attached AC power cables and mounting hardware.



Fan-4

- ◆ Mounts easily to FTP roof insert as well as FPL 1, FPL2 and FPL3 rack panels
- ◆ Moves 95 cubic feet of air per minute **32.95**

Fan-10

- ◆ Mounts easily to FTP-10 roof insert
- ◆ 10" ball-bearing fan 550 cubic feet of air per minute
- ◆ Free air rating of 49dBA **146.95**

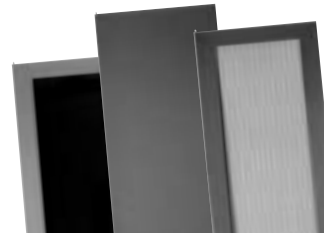

Enclosure Doors

Available for KAR, GAR, and SWR racks; in solid 16-gauge steel, perforated (66% open area) or in smoked plexi. Keyed lock installed. Finished in a black powder coat.

For Door	Perforated Doors	Price	Plexi Doors	Price	Solid Doors	Price
GAR-35	GARD-35P	139.95	GARD-35PLX	195.95	GARD-35	369.95
GAR-40	GARD-40P	209.95	GARD-40PLX	398.95	GARD-40	146.95
GAR-44	GARD-44P	224.95	GARD-44PLX	424.95	GARD-44	154.95
KAR-18	KARD-18P	139.95	KARD-18PLX	204.95	KARD-18	92.95
KAR-24	KARD-24P	159.95	KARD-24PLX	249.95	KARD-24	109.95
KAR-35	KARD-35P	179.95	KARD-35PLX	359.95	KARD-35	118.95
KAR-40	KARD-40P	209.95	KARD-40PLX	426.95	KARD-40	124.95
KAR-44	KARD-44P	209.95	KARD-44PLX	426.95	KARD-44	132.95
SWR-10	SWRD-10P	118.95	SWRD-10PLX	174.95	SWRD-10	64.95
SWR-18	SWRD-18P	139.95	SWRD-18PLX	204.95	SWRD-18	94.95
SWR-24	SWRD-24P	154.95	SWRD-24PLX	239.95	SWRD-24	99.95
SWR-35	SWRD-35P	179.95	SWRD-35PLX	364.95	SWRD-35	124.95

RAXXESS

COMMERCIAL PRODUCTS

Enclosed Audio Rack (KAR)

- ◆ Welded, 16-gauge cold rolled steel construction with fully adjustable front rack rail
- ◆ Front adjustable 11-gauge rack rail
- ◆ 16-gauge steel rack rail supports
- ◆ Available in 2 depths, for equipment up to 20" and 25"
- ◆ Variety of conduit knockouts are located at the top and bottom rear
- ◆ Punched rack rail supports with multiple cable tie offs
- ◆ Perforated sides provide ventilation
- ◆ Optional front and rear locking doors are easily removable for left or right swing
- ◆ A removable 3 space solid roof insert allows for interchangeable panels for fans or passive cooling
- ◆ Black powder coat finish



Model	Panel Space	Depth	Width	Height	Height w/Casters	Price
KAR-18-22	18 space (32")	22"	21 1/8"	36"	37 1/2"	294.95
KAR-18-28	18 space (32")	22"	21 1/8"	36"	37 1/2"	308.95
KAR-24-22	24 space (42")	22"	21 1/8"	46 1/2"	48"	314.95
KAR-24-28	24 space (42")	28"	21 1/8"	46 1/2"	48"	335.95
KAR-35-22	35 space (61 1/4")	22"	21 1/8"	65 1/2"	67 1/4"	342.95
KAR-35-28	35 space (61 1/4")	28"	21 1/8"	65 1/2"	67 1/4"	378.95
KAR-40-20	40 space (70")	20"	21 1/8"	74 1/4"	76"	378.95
KAR-44-22	44 space (77")	22"	21 1/8"	81 1/2"	83"	389.95
KAR-44-28	44 space (77")	28"	21 1/8"	81 1/2"	83"	419.95

Sectional Wall Rack (SWR)

- ◆ Fully welded 12 and 14-gauge construction, internal bracing, reinforced hinges and integral center section supports for maximum strength
- ◆ Adjustable 11-gauge steel rack rail, ventilated sides and top and bottom conduit knockouts
- ◆ Keyed locks between the center and rear sections
- ◆ Center section and optional door can swing left or right
- ◆ 6" square knock-out for cable passage
- ◆ Tie off strips for cable management
- ◆ Attractively finished in durable black powder coat
- ◆ Optional locking rod and locking door available
- ◆ Hinging system eases installation and provides greater security



Model	Panel Space	Center Depth	Rear Depth	Height	Price
SWR-10-12	10 space (17 1/2")	12"	4 1/2"	21 1/4"	272.95
SWR-10-17	10 space (17 1/2")	17"	4 1/2"	21 1/4"	286.95
SWR-18-12	18 space (31 1/2")	12"	4 1/2"	35 1/4"	370.95
SWR-18-17	18 space (31 1/2")	17"	4 1/2"	35 1/4"	412.95
SWR-24-12	24 space (42")	12"	4 1/2"	46 1/4"	440.95
SWR-24-17	24 space (42")	17"	4 1/2"	46 1/4"	510.95
SWR-35-17	35 space (61 1/4")	17"	4 1/2"	65 1/2"	636.95

Wall Mount Rack (WMK)

- ◆ Compact audio enclosures for smaller installations
- ◆ 16-gauge steel, finished in durable black powder coat
- ◆ 11-gauge rack rails
- ◆ Top and bottom conduit knockouts and slotted sides for passive cooling
- ◆ Key hole slots on rear panel allow for secure attachment to wall
- ◆ WMK-10 utilizes a rear mounting pan with a laser knockout for cable passage
- ◆ Mounting pan facilitates servicing equipment and uses a locking rod for real rack security
- ◆ Front locking door can swing from left to right and is 1.5" deep



Model	Panel Space	Width	Depth	Height	Price
WMK-7	7 space (12 1/4")	22 1/4"	17"	15 1/2"	153.95
WMK-10	10 space (17 1/2")	22 1/4"	17 1/4"	20 1/4"	244.95



Set of 4 Levelers (FL)

Fit all GAR and KAR racks.

Adapter plate included....**25.95**



Set of 4 Casters

Hard rubber, 2.5", ball bearing swivel caster; 175 lb. capacity.

CASTER-CM**45.95**

CASTER-CMLCK

Locking caster**51.95**

Tie Bars

19" rack mountable 1/4" diameter rods. Efficient horizontal cable management.

TBO offset.....**4.50**

TBS straight.....**3.95**

77" Lacer Strip

11-gauge steel; mounts vertically to rack rail supports for cable management. Can be cut to any length.

LCS offset.....**14.95**

RAXXESS

COMMERCIAL PRODUCTS

STUDIO ACCESSORIES

1430

Rotating Rack System (ROTR)

Perfect for installing in existing cabinetry or new millwork, the Raxxess Swivel Rack system comes in sizes from eight to twenty four rack spaces. Available in a two or four slide formats capable of supporting 150 and 300 pounds respectively. The rack extends a full 20" from its frame and

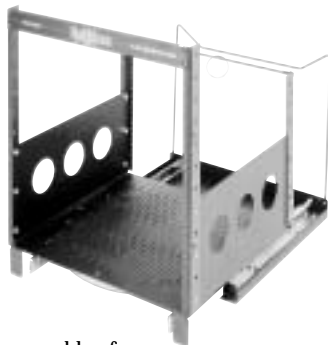

is then capable of rotating 90° in either direction, allowing unobstructed access to components regardless of their depth. The system locks in the closed position with security panel and screws provided. Easy and effective cable management system and eight-space rear rack rail are included.

ROTR-2
2 sliders, specify height.....**335.95**

ROTR-4
4 sliders, specify height.....**384.95**



Skeleton Rack (SKR)

- ◆ A "Bare Bones" approach to racking audio equipment
- ◆ Constructed of four pieces of 11-gauge steel rack rail (cut to any length up to 42 spaces 73.50") and a top and bottom pan of 16-gauge cold rolled steel
- ◆ Surprisingly strong, yet assembles in less than five minutes with a standard wrench
- ◆ Optional side panels are available (12, 24 and 42 spaces) in either 16-gauge steel with a black powder coat finish or Elite panels in ebony fleck or mahogany laminate with solid oak edging



Model	Panel Space	Depth	Width	Height	Height w/Casters	Price
SKR-12	12 space (21")	20"	19 1/4"	26 3/4"	28 3/4"	97.95
SKR-24	24 space (42")	20"	19 1/4"	47 1/4"	49 1/4"	125.95
SKR-42	42 space (73 1/2")	20"	19 1/4"	78 1/4"	80 1/4"	153.95

Captive ROTR Rack (ROTR/CAPTIVE)

Installing and maintaining equipment in traditional commercial racks can be a time consuming and tedious process. While moving a rack around on casters can provide some degree of accessibility, Raxxess has a better way.

Designed to save you time and money on service calls by enabling unprecedented access to installed equipment, the new Captive ROTR rack is an idea whose time has finally come. Available in 35 rack spaces, the Captive ROTR rack consists of a rollout 22" deep rack frame on heavy-duty 4" casters and a 16-gauge welded steel housing. A ball-bearing swivel base sits between the caster base and the reinforced 12-gauge rack frame

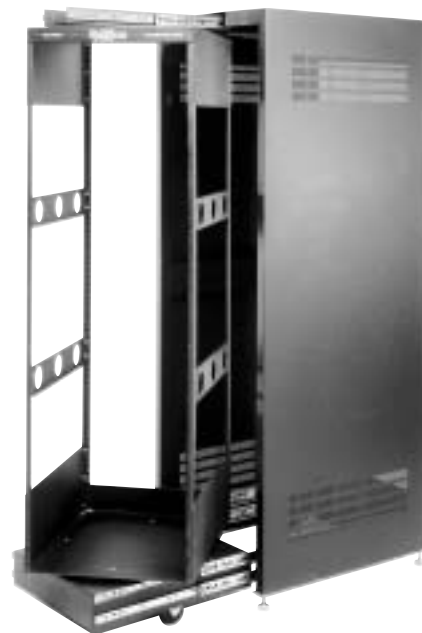

allowing 90-degree rotation when the rack frame is at full extension. Heavy duty 28" full-extension telescoping sliders allow the rack frame to move smoothly in and out of the housing. Our unique "Omega" shaped, 3" wide cable passage cutout in the roof combined with ample cable tie-off points in the rack allow for easy cable management.

CPROTR-35 35 spaces**1119.00**

CPROTR-42 42 spaces**1189.00**

Security Door

Button mount security door attaches directly to rack rail. Can be removed with ease and no tools.

SCDR-8B
8 space button mount.....**58.95**

SCDR-12B
12 space button mount.....**64.95**

SCDR-16B
16 space button mount.....**77.95**

SCDR-20B
20 space button mount.....**89.95**



PANELS

FPL Fan Panel

Heavy duty, 16 gauge steel; three space panels: punched to accommodate 4 1/2" diameter fans; textured finish.

- FPL-1** Holds 1 fan**21.95**
- FPL-2** Holds 2 fans.....**23.95**
- FPL-3** Holds 3 fans.....**25.95**

VPL Vent Panel

For passive cooling of racks; .125" aluminum. Black brushed anodized.

- VPL-1** 1 space...**10.95** **VPL-2** 2 spaces..**13.95**
- VPL-3** 3 spaces**14.95**

AFG Aluminum Flanged Panel

Attractive 1/2" flanged for additional strength; sturdy .060 aluminum; easily machined. Black brushed anodized.

- AFG-1** 1 space ..**12.95** **AFG-2** 2 spaces..**14.95**
- AFG-3** 3 spaces..**15.95** **AFG-4** 4 spaces..**19.95**

SFT Steel Flat Panel

Sturdy 14-gauge cold rolled steel; perfect for use where economy is the key; smooth finish.

- SFT-1** 1 space**5.95** **SFT-2** 2 spaces.....**6.95**
- SFT-3** 3 spaces.....**8.95** **SFT-4** 4 spaces.....**9.95**

SFG Steel Flanged Panel

16-gauge, cold rolled steel; 1/2" flanged for additional strength. Perfect for use where economy is the key; textured finish.

- SFG-1** 1 space.....**8.95** **SFG-2** 2 spaces ..**10.95**
- SFG-3** 3 spaces ..**11.95** **SFG-4** 4 spaces ..**13.95**

AFT Aluminum Flat Panel

.125" aluminum; easily machined. Black brushed anodized.

- AFT-1** 1 space**11.95**
- AFT-2** 2 spaces.....**14.95**
- AFT-3** 3 spaces.....**15.95**
- AFT-4** 4 spaces.....**17.95**

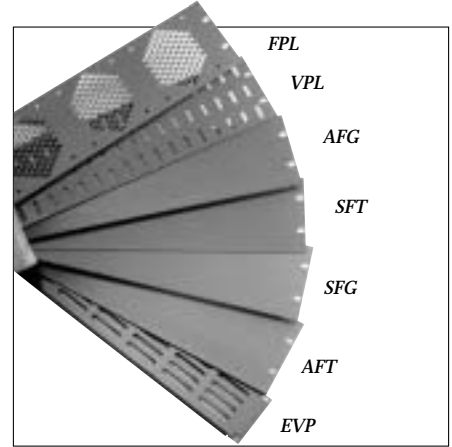

EVP Economy Vent Panel

Inexpensive flanged panel for passive cooling; 16-gauge, cold rolled steel; smooth finish.

- EVP-1** 1 space.....**7.95** **EVP-2** 2 spaces ..**10.95**
- EVP-3** 3 spaces**13.95**

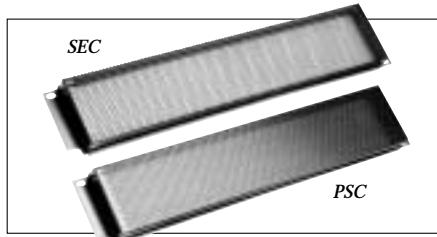

Perforated Steel Security Covers

One-piece 16-gauge perforated steel covers protect equipment from tampering. 1" offset allows knob clearance. Neoprene gasket edges prevents scratches. Screw notches allow removal of the cover without removing the gear. Black baked enamel finish. The SEC series has 5/32" holes that provide a clear view of secured equipment. The PSC series has 1/16" holes creating an obstructed view.

- SEC-1** 1 space....**15.95** **PSC-1** 1 space....**15.95**
- SEC-2** 2 spaces ..**16.95** **PSC-2** 2 spaces ..**16.95**
- SEC-3** 3 spaces ..**18.95** **PSC-3** 3 spaces..**18.95**

Perforated and Fine Vent Panels

One piece 16-gauge steel construction; finished in black baked enamel. The 5/32" perforations in the PVP series allow optimum air circulation, while the 1/16" perforations of the FVP provide a more limited view.

- PVP-1** 1 space**9.95** **FVP-1** 1 space.....**9.95**
- PVP-2** 2 spaces..**10.95** **FVP-2** 2 spaces ..**10.95**
- PVP-3** 3 spaces..**12.95** **FVP-3** 3 spaces..**12.95**

Single Space Connector Panels

Constructed of 16-gauge cold rolled steel and flanged for strength.

- S12F** for 12 female XLR's**7.95**
- S12H** for 12 male XLR's**7.95**
- S12M** for 6 male and 6 female XLR's**7.95**
- S16.25** for sixteen 1/4" connectors.....**7.95**

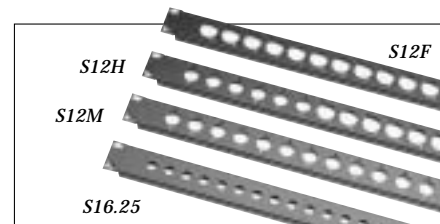

Hinged Steel Flanged Panels

16-gauge flanged steel panel with textured finish. Hinged to allow access to your rack via the front panel. Perfect for bringing electrical wiring and connectors to the front of the rack.

- SFG-2H** 2 spaces**Call**
- SFG-3H** 3 spaces**Call**
- SFG-4H** 4 spaces**Call**

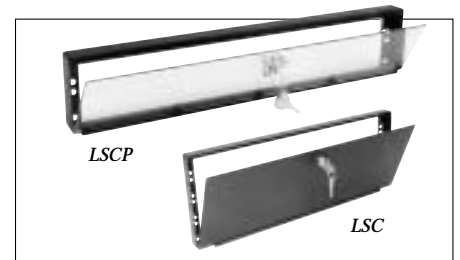
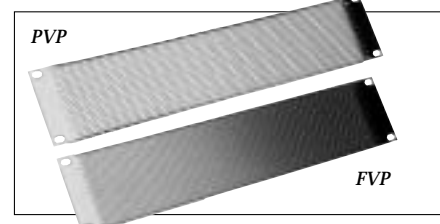

Locking Security Covers

The ultimate in security for rack-mounted devices. Heavy gauge steel frame construction, with either a black steel or see-through plexi front panel. The eight-space version is available with 2, four space plexi or steel panels. Perforated available as an option.

- LSC-2** 2 space, black steel**28.95**
- LSC-4** 4 space, black steel**32.95**
- LSCP-2** 2 space, plexi**35.95**
- LSCP-4** 4 space, plexi**39.95**
- LSCP-8** two 4 space, plexi**58.95**

Hinged Vent Panel

A hinged vent panel that opens side to side, left or right. Captive screws thread directly into rack rail; constructed of 16 gauge, perforated 5/32" steel. Occupies 6 rack spaces; finished in black baked enamel.

- HVP-6**.....**38.95**

RAXXESS

MODULAR PANELS

SCSI Module

Fits SCSI connectors 25 and 50 pin.

DB25-1.....	7.95	DB25-2.....	7.95
DB25-3.....			7.95

Canare BNC Module

Fits Switchcraft, Neutrik (FP, LNEFP), Cannon.

XLR-1M.....	7.95	XLR-2M.....	7.95
XLR-3M.....	7.95	XLR-4M.....	7.95
XLR-5M.....	7.95	XLR-6M.....	7.95

RCA Module

With 1/4" hole fits RCA jacks and LEDs.

RCA-1.....	7.95	RCA-2.....	7.95
RCA-3.....	7.95	RCA-4.....	7.95
RCA-5.....	7.95	RCA-6.....	7.95
RCA-7.....	7.95	RCA-8.....	7.95

Phone Module

With 3/8" hole for phone jacks and F connectors.

PH-2.....	7.95	PH-3.....	7.95
PH-4.....	7.95	PH-5.....	7.95
PH-6.....	7.95	PH-7.....	7.95
PH-8.....			7.95

XLR Female Module

Fits Switchcraft, Cannon, Neutrik (FP, LNEFP, Speakon), Whirlwind WC3F-M.

XLR-1F.....	7.95	XLR-2F.....	7.95
XLR-3F.....	7.95	XLR-4F.....	7.95
XLR-5F.....	7.95	XLR-6F.....	7.95

XLR Male Module

Fits Switchcraft, Neutrik (FP, LNEFP), Cannon

XLR-1M.....	7.95	XLR-6M.....	7.95
XLR-1M.....	7.95	XLR-6M.....	7.95
XLR-1M.....	7.95	sXLR-6M.....	7.95

Universal

Fits Switchcraft XLR male and female and Neutrik FDL, MDL, FP and MP.

UN-2.....	7.95	UN-3.....	7.95
UN-4.....	7.95	UN-6.....	7.95

Elco Module

Fits 38, 56, 90 and 120 multipin Elco connectors.

EL-1-38.....	7.95	EL-2-38.....	7.95
EL-1-56.....	7.95	EL-2-6.....	7.95
EL-1-90.....	7.95	EL-2-90.....	7.95
EL-1-120.....			7.95

Multipin Whirlwind Module

WH-39 Fits Whirlwind 39-pin connectors.....	7.95
WH-61 Fits Whirlwind 61-pin connectors.....	7.95
MP-190 For use with modular panels in a standard 1900 box.....	7.95

Midi/Duplex Module

Fits standard MIDI connectors.

MIDI-1.....	7.95	DP-1.....	7.95
MIDI-2.....	7.95	DP-2.....	7.95
MIDI-4.....			7.95

Banana Module

Fits dual universal banana jacks for speakers.

BAN-1.....	7.95	BAN-2.....	7.95
BAN-3.....	7.95	BAN-4.....	7.95
BAN-6.....			7.95

Hubbel Twistlock Module

HUB-1.....	7.95
------------	------

Neutrik NL8MPR Module

NL-8.....	7.95
-----------	------

Modular Wall Box

Modular panels allow users to create a custom connector system using stock panels. Available as a 19" rack frame (one piece construction) or as a 2, 4 or 6 panel attractive wall box. Panels are aluminum and measure 3 1/2 x 3 1/2". Wall boxes (MWB) are of 16-gauge steel construction.

MCP - Modular connector panel, aluminum.....	7.95
MWB-2 Holds 2 modular panels.....	23.95
MWB-4 Holds 4 modular panels.....	29.95
MWB-6 Holds 6 modular panels.....	33.75

MCF - Connector Frame

Holds 5 panels.....	13.49
---------------------	-------

Modular Blank Panel

3.5" square aluminum panel with no connector punchout.

Fits MCF or MWB.....	7.95
----------------------	------

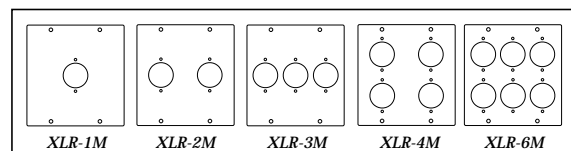
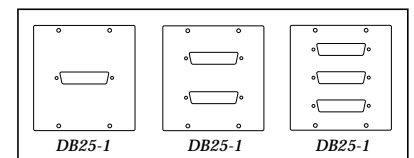

ULTIMATE

STUDIO MONITOR STANDS

Monitor Speaker Stands

Ultimate Support monitor stands feature cabinet-quality top plates, cable management, metal base spikes, and the ability to add shot or sand internally. They are also great for living rooms to get those expensive speakers up to ear level and produce the sharpest and clearest sound possible.

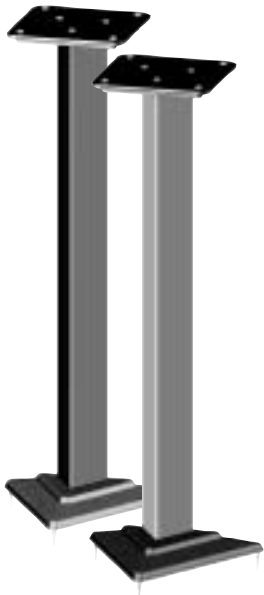

Cabinet Quality Medium-Density Fiberboard Top Plate

Place monitors on rubber pads that isolate the monitor cabinet from vibration.

Cable Management System

Two cable channels run inside the column to separate balanced or unbalanced cables from the power cable. Just lay them in the open-faced channels and snap on the backing. Wrap extra cable on pegs hidden beneath the stand.

Stable Stand

The aluminum column filled with shot or sand combined with the cast-zinc base, creates a bottom-heavy, ultra-stable stand.

Metal Base Spikes

To bypass the sound-dampening effect, metal base spikes go through the carpet and padding to rest on the subfloor. For hard surfaces use enclosed rubber feet.

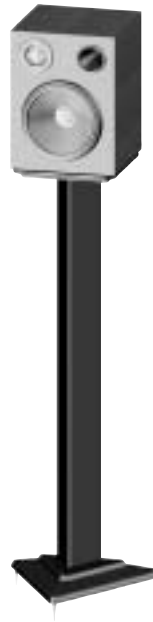

All Studio Monitor Stands are sold in pairs, have a 14" base, a 9 x 9" top plate and a load capacity of 75 lbs.

	Height	Weight	Color	Price
MS-12B2	12"	5.7 lbs.	Black	Call
MS-12P2	12"	5.7 lbs.	Pewter	Call
MS-18B2	18"	6.4 lbs.	Black	Call
MS-18P2	18"	6.4 lbs.	Pewter	Call
MS-24B2	24"	7.1 lbs.	Black	Call
MS-24P2	24"	7.1 lbs.	Pewter	Call
MS-30B2	30"	7.8 lbs.	Black	Call
MS-30P2	30"	7.8 lbs.	Pewter	Call
MS-36B2	36"	8.45 lbs.	Black	149.00
MS-36P2	36"	8.45 lbs.	Pewter	149.00
MS-45B2	45"	9.55 lbs.	Black	159.00
MS-45P2	45"	9.55 lbs.	Pewter	159.00

Choosing a Stand Height

When seated in the mix position, measure the distance from your ears to the floor and choose the stand height (36" or 42") that will place the monitor tweeters at ear level. Low frequency sound waves are large and fill a lot of space. High frequencies come from smaller, direct waves. Studio monitors are designed so that on-axis response (direct parallel path from monitor to ears) yields the most accurate sound.

KÖNIG & MEYER X-STYLE KEYBOARD STANDS

QUALITY GERMAN-ENGINEERED X-STANDS

E-Z Adjust X-Stand (18940B)

This sturdy, medium-duty steel frame has a durable black finish. It features an easy adjust button, which allows you to simply open the stand to the desired height and release. The stand locks firmly into place. Push the button to close the stand.

Performer X-Stand (18962B)

This light-duty X-stand features a pin system which allows the stand to open to a pre-set height every time. A dual-position center point allows a greater range of height adjustment.

	Set-Up Height	Weight	Load Capacity	Price
E-Z Adjust	18-39"	11 lbs.	165 lbs.	49.00
Performer	25-35"	7 lbs.	90 lbs.	35.00



E-Z Adjust X-Stand



Performer X-Stand

ULTIMATE

SPEAKER STANDS

STUDIO ACCESSORIES

1434

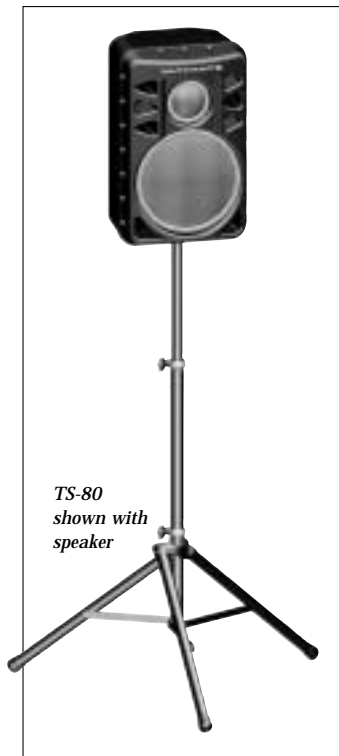

TS-80
shown with
speaker

TS-80 Series Speaker Stands

These high-quality aluminum and steel tripod speaker stands feature a built-in socket adapter that accommodates both 1 $\frac{3}{8}$ " and 1 $\frac{1}{2}$ " speaker sockets. A glass-reinforced telescoping collar has a die-cast metal clamp for maximum security and durability. The secure leg collar slides smoothly on the tube for easy set-up.



◆ Glass reinforced polycarbonate fitting at the leg juncture uses a metal clamp over the fitting to minimize over-tightening and breakage

◆ The stands raise and lower with the turn of a knob, locking tightly for secure support. Metal clamps minimize over-tightening and breakage

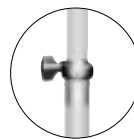

◆ The rubber footcaps are held in place by both internal and external friction so they stay on gig after gig

◆ The connector tube, which telescopes up to accommodate 1 $\frac{3}{8}$ " speaker sockets and down for 1 $\frac{1}{2}$ " sockets. Locks firmly into desired position. Minimizes the need for adapters. The telescoping tube lock prevents accidentally pulling out the center tube

Telescoping and Leg Collars

Die-cast metal clamps fit snugly over glass-reinforced polycarbonate fittings creating the strongest and most durable telescoping collar and leg collar possible. Since the handknob actually tightens the metal clamp and not the plastic directly, these collars aren't easily overtightened, snapped or cracked!

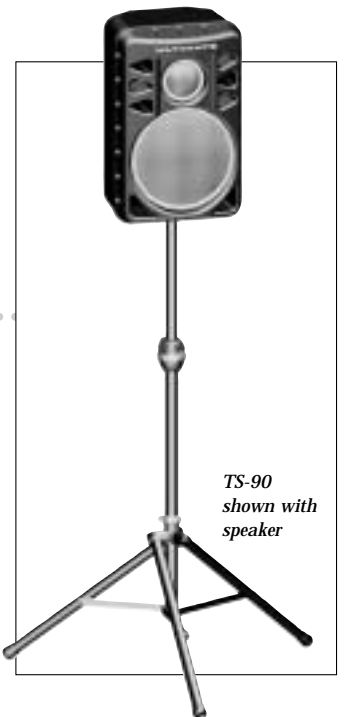

TS-90
shown with
speaker

TS-90 Series Speaker Stands

A step-up from the TS-80, the TS-90 tripod speaker stands features a telescoping tube lock that increases safety and prevents accidentally pulling the center tube. It has an internal friction mechanism with three settings. In the "RAISE" setting, the mechanism grips and holds the tube, allowing you to incrementally pull the center tube up to the required height. "LOCK" the collar in place for extra security. In the "LOWER" setting, TeleLock eases off and assists lowering the center tube. This unique design safely takes the strain off you!



TRIPOD SPEAKER STANDS											
	TS-70B	TS-80B	TS-80S	TS-88B	TS-88S	TS-88BL*	TS-90B	TS-90S	TS-99B	TS-99S	TS-99BL*
Height	50" - 77"	44" - 79"	44" - 79"	62" - 110"	62" - 110"	62" - 110"	44" - 79"	44" - 79"	62" - 110"	62" - 110"	62" - 110"
Weight	5 lbs. 4 oz.	6 lbs. 4 oz.	6 lbs. 4 oz.	8 lbs.	8 lbs.	9 lbs.	6 lbs. 4 oz.	6 lbs. 4 oz.	8 lbs.	8 lbs.	9 lbs.
Base Diameter	40"	47"	47"	62"	62"	62"	47"	47"	62"	62"	62"
Load Capacity	100 lbs.	150 lbs.	150 lbs.	150 lbs.	150 lbs.	150 lbs.	150 lbs.	150 lbs.	150 lbs.	150 lbs.	150 lbs.
Folded	41 $\frac{1}{2}$ " x 5"	43 $\frac{1}{2}$ " x 5 $\frac{1}{2}$ "	43 $\frac{1}{2}$ " x 5 $\frac{1}{2}$ "	57 $\frac{1}{2}$ " x 5 $\frac{1}{2}$ "	57 $\frac{1}{2}$ " x 5 $\frac{1}{2}$ "	57 $\frac{1}{2}$ " x 6"	43 $\frac{1}{2}$ " x 5 $\frac{1}{2}$ "	43 $\frac{1}{2}$ " x 5 $\frac{1}{2}$ "	57 $\frac{1}{2}$ " x 5 $\frac{1}{2}$ "	57 $\frac{1}{2}$ " x 5 $\frac{1}{2}$ "	57 $\frac{1}{2}$ " x 6"
Color	Black	Black	Silver	Black	Silver	Black	Black	Silver	Black	Silver	Black
Price	60.00	85.00	80.00	105.00	94.50	129.50	105.00	96.00	125.00	110.00	149.00

*The TS-88L and TS-99BL are Leveling Leg Tripods. The leg adjusts in length to level the stand on uneven surfaces.



ULTIMATE

SPEAKER STANDS

MUSIKA TS-70B ECONOMY SPEAKER STAND

The Musika TS-70 tripod speaker stand was designed to bring Ultimate quality to the masses with a more affordable speaker stand. Although it is not a heavy duty stand like the TS-80 or TS-90 series, it still brings quality and innovation to this segment.

- ◆ Glass reinforced telescoping collar secures the telescoping tube without slipping. A safety pin is also included for extra security

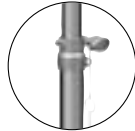

- ◆ Glass reinforced tripod leg fitting secures the base of the tripod. By using a glass reinforced plastic ultimate tripods are stronger and more durable than the competition



- ◆ Like all tripod speaker stands from Ultimate, the TS-70 includes an adapter for 1 1/2" speaker sockets as well as 1 3/8" sockets



MOUNTING BRACKETS

BMB-200K Large Mounting Bracket

- ◆ External 4 x 6" bracket securely mounts any speaker cabinet with a flat bottom on an Ultimate tripod (1 1/2" tube)
- ◆ Glass-reinforced polycarbonate fitting holds 100 lbs.
- ◆ All hardware included for installation (ULBMB200K).....**16.80**



TMB-400K Slide Mounting Bracket

- ◆ Low-profile external 4 x 4" bracket securely mounts any speaker cabinet with a flat bottom on an Ultimate tripod (1 1/2" tube)
- ◆ Two-piece design: the plate attaches to the bottom of the speaker, and the slide-in base connects securely to the tripod
- ◆ All hardware included for installation
- ◆ Strong glass-reinforced polycarbonate fitting holds 100 lbs.
- (ULTMB400K).....**12.00**

TAD-100 Adapter Stud (ULTAD100)

- ◆ Converts a 1 1/2" tripod top tube to mount a speaker cabinet with a 1" inside diameter socket
- ◆ Strong glass-reinforced polycarbonate fitting holds 100 lbs.....**11.25**



TAD-138 Adapter Stud (ULTAD138)

- ◆ Same as above but converts 1 1/2" top tube to 1-1 3/8".....**10.00**

TSM Series Socket Mounting Brackets

- ◆ Internal 4" diameter bracket securely mounts to most any speaker cabinet with a flat bottom on an Ultimate tripod
- ◆ All hardware included for installation

TSM-150K (ULTSM150K)

- ◆ 1 1/2" cavity. Glass-reinforced polycarbonate fitting holds 100 lbs.....**12.00**

TSM-150MK (ULTSM150MK)

- ◆ 1 1/2" cavity. Metal fittings hold 150 lbs.....**14.25**

TSM-138MK (ULTSM138MK)

- ◆ 1 3/8" cavity. Metal fittings hold 150 lbs.....**13.50**

BAGS



BAG-80 Zippered Tote Bag (ULBAG80)

- ◆ Holds one TS-80 or TS-90 series tripod stands. 5.9 x 5.9 x 48".....**19.95**



BAG-80D Zippered Tote Bag (ULBAG80D)

- ◆ Double bag—holds two TS-80 or TS-90 series tripod stands. 5.9 x 11.8 x 44.5".....**35.00**



BAG-88 Zippered Tote Bag (ULBAG88)

- ◆ Holds one TS-88 or TS-99 series tripod stands. Also holds a TS-88BL or TS-99BL tripod. 5.9 x 5.9 x 63".....**24.95**



BAG-88D Zippered Tote Bag (ULBAG88D)

- ◆ Double bag—holds two TS-88 or TS-99 series tripod stands. Also holds two TS-88BL or TS-99BL tripods. 5.9 x 11.8 x 63".....**34.95**

ULTIMATE

KEYBOARD STANDS

STUDIO ACCESSORIES

1436

IQ X-Stands

These high-performance stands offer many features including:

Memory Lock

Set the stands to different positions - memory lock opens to your choice every time.

Stable Stand

Large footprint and tubing make these stands extremely stable. Adjustable end-caps stabilize the stand on uneven surfaces.

Cable Management

Clips throughout stands and tiers.

Reinforced Connectors

The IQ-1500, 2000 and 3000 stands have connections between the leg braces and top/bottom tubes that increase strength and durability over welded x-stands.

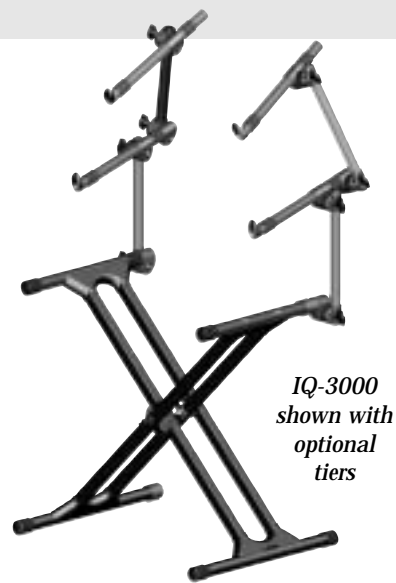
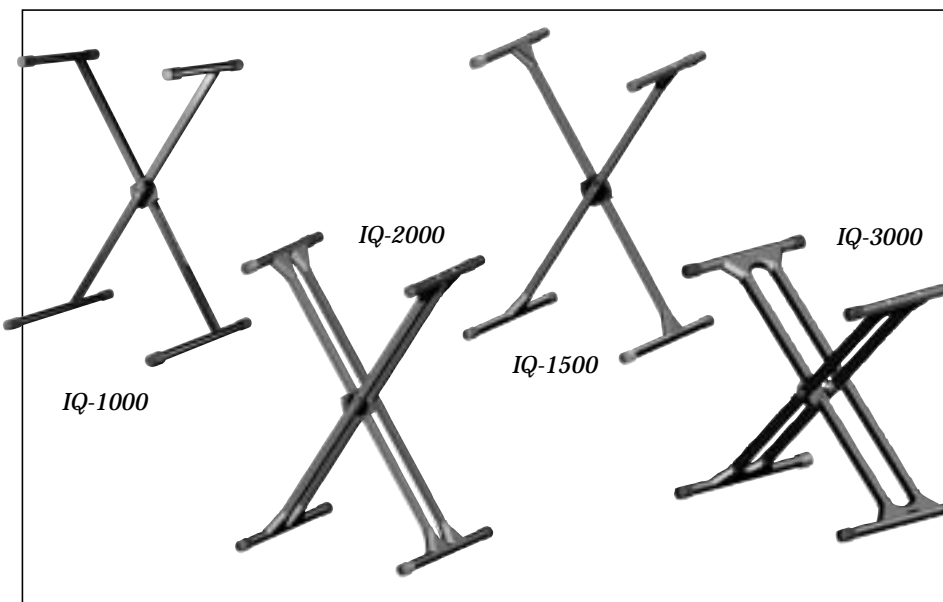

IQ-3000 shown with optional tiers

IQ-1000

- ◆ 14" support arms, 20" leg lengths
- ◆ 100 lb. load capacity
- ◆ Memory Lock system with 4 height adjustment settings
- ◆ Off-set leg braces make more leg room and space for pedals
- ◆ Adjusting end caps
- ◆ Accommodates IQ-200 set-position second tier

\$35.00

IQ-1500

Same as above, plus-

- ◆ 16½" support arms, 20" leg lengths
- ◆ Reinforced connectors between leg braces and top/bottom tubes increase strength and durability over welded x-stands
- ◆ Accommodates optional IQT-200 fully-adjustable second tier

Call

IQ-2000

Same as above, plus-

- ◆ Sturdy, double brace stand
- ◆ 150 lb. load capacity
- ◆ Accommodates 2 optional IQT-200 fully-adjustable second and third tiers

\$54.00

IQ-3000

Same as above, plus-

- ◆ 19½" support arms, 22" leg lengths
- ◆ 300 lb. load capacity (for the lowest 2 settings, 25" and 27", load capacity is 250 lbs.)
- ◆ Memory Lock system with 9 height adjustment settings
- ◆ Accommodates optional IQT-100 and IQT-200 fully-adjustable second and third tiers

Call

IQ X-STANDS

	IQ-1000	IQ-1500	IQ-2000	IQ-3000
Set-up Height	26½" - 36"	26½" - 36"	26½" - 36"	25" - 37"
Weight	11 lbs.	12 lbs.	15 lbs.	22 lbs.
Load Capacity without Tiers	100 lbs.	100 lbs.	150 lbs.	300 lbs.
Load Capacity with Tiers	100 lbs. distributed	100 lbs. distributed	150 lbs. distributed	300 lbs. distributed
Stand/2nd Tier/3rd Tier (lbs.)	75/25/-	75/25/-	75/50/25	125/100/75

Accessories

IQ-200 Set-Position Second Tier

Second tier holds a 2nd keyboard. For the IQ-1000.....**29.95**

IQT-100 and IQT-200 Tiers are height, depth, width and angle adjustable.

Height and depth from 1" to 12", tier angle and width in 7.5° increments.

Tiers come with a 3-year warranty.

IQT-200 Adjustable Tier

Used as a 2nd tier on the IQ-1500; a 2nd and 3rd tier on the IQ-2000; and a 3rd tier on the IQ-3000....**42.00**

IQT-100 Adjustable Tier

Used as a second tier on the IQ-3000**49.00**



EQUIPMENT LEASING AVAILABLE

ULTIMATE

KEYBOARD STANDS

Apex AX-48BP Column Keyboard Stand

The Apex column keyboard stands have set the standard in the industry for performing musicians. Ingenious design makes them incredibly easy to set up, adjust and transport.

- ◆ Sleek, hollow column becomes its own carrying case. Sets up in seconds with no tools
- ◆ Sturdy column stand is stable, even with large 88-note keyboards
- ◆ Arms firmly support the keyboard yet detach and slide into the top of the column for easy transport. Includes two column tiers that are expandable to three with Apex accessories
- ◆ Comes with two standard clamps and two sets of 13" tribar arms
- ◆ Legs slide out into place for quick set-up or store neatly inside column base for transport.
- ◆ Durable black anodized aluminum looks great on any stage.
- ◆ 46" height with angle adapter. It weighs 19 lbs., has a load capacity of 125 lbs per tier; 220 lbs. total. The collapsed length is 52"

§162.00

AX-48BP Apex Plus

Same as above, includes an Apex Mic Boom plus a Super Clamp and 18" long tribars to accommodate a larger keyboard**218.95**

AX-48BLX Apex Deluxe

Comes with one standard clamp, 13" tribar arms one super clamp and 18" long tribar arms to accommodate a larger keyboard**Call**



AX-48B
Apex

STUDIO ACCESSORIES

1437

apex accessories

Tribars and Clamps

For keyboard tier assembly.
Requires 2 tribars and 1 clamp.

TBR-130

Standard Tribar (13")each 9.75

TBR-180

Long Tribar (18")each 9.75

CMP-480

Standard Clamp. For use with standard 13" tribars only**Call**

CMP-485

Super Clamp. For use with 18" long and standard tribars ...**21.00**

MIC-480 Mic Boom

Microphone adapter with 24" boom. Includes hardware for attaching to the stand**28.00**

BAG-88

Zippered tote bag. Fits entire APEX column into tote bag for transport**24.95**



Deltex DX-48B Keyboard Stand

An economical yet high quality choice for musicians with lighter keyboards.

- ◆ Sleek triangular column design with a durable black anodized finish.
- ◆ Sturdy column holds up to two keyboards
- ◆ Arms firmly support the keyboard yet detach for easy transport
- ◆ Folding legs detach and store in the optional tote bag
- ◆ Durable black anodized aluminum looks great on any stage.
- ◆ 47" height; weighs 14 lbs, it has a load capacity of 50 lbs. per tier (100 lbs. total). It's collapsed length is 45"

§105.00

DX-48BP Deltex Plus

Includes a DX-48B plus the BAG-88 tote bag**Call**

deltex accessories

BAG-88 Zipper Tote Bag

Heavy-duty nylon tote bag holds one Deltex stand. Dimensions are 10½ x 60½"**24.95**



ULTIMATE

KEYBOARD and HOME STUDIO STANDS

STUDIO ACCESSORIES

1438



Apache Triple Tier A-Frame Stand

The Apache Triple Tier frame is a versatile option for stage or studio. Each tier is height and tilt adjustable, while the back legs can be positioned vertically to optimize valuable studio space. It is available in 5' and 4' widths, and comes with three tiers, three pairs of 1 1/4" support bars and a tote bag. (The top tier on the 60" wide Apache has 20" support bars.)

This frame is easily expandable with a wide variety of accessories.

	AP-22BPT	AP-26BPT
Height	60"	60"
Width	48"	60"
Load Capacity per Tier	150 lbs.	150 lbs.

Studio Organizer

Designed to keep your gear within arm's reach. Components are height and tilt adjustable and the modular design is expandable with a variety of accessories. The kit includes a large laminated worktable, top-tier with two 1 1/4" support bars and two half-tiers with 3/4" support bars.



HS-26BP STUDIO ORGANIZER

Height	Worktable	Footprint	Weight	Load Capacity	Price
27 1/2" - 32"	16" x 35 1/2"	19" x 38"	21 lbs.	150 lbs. total distributed	175.00

THINKERTOYS

Customize your existing stand or build your own stand from the ground up. Thinkertoys provide a means of connecting Ultimate aluminum tubing with fittings, connectors, swivels, casters, foot caps, shelves, hand-knobs, speaker mounts, lighting attachments, legs and more. If you can't find a support to match your needs for instruments, computers, and equipment, ThinkerToys are for you.

Aluminum Tubing

Available in one foot increments up to 12 feet in silver or black anodized finish.

- 12067 Standard Silver Tubing**
1 1/2" diameter; .049 thickness.....**3.00**
- 12068 Standard Black Tubing**
1 1/2" diameter; .049 thickness.....**4.00**
- 13523 Small Diameter Tubing**
1 1/8" diameter; .049 thickness **6.00**
- 12069 Large Diameter Silver Tubing**
1 1/2" diameter; .058 thickness **4.00**
- 12070 Large Diameter Black Tubing**
1 1/2" diameter; .058 thickness **5.00**
- 12074 Thick Walled Silver Tubing**
1 1/2" diameter; .125 thickness..... **5.00**
- 12075 Thick Walled Black Tubing**
1 1/2" diameter; .125 thickness..... **5.95**

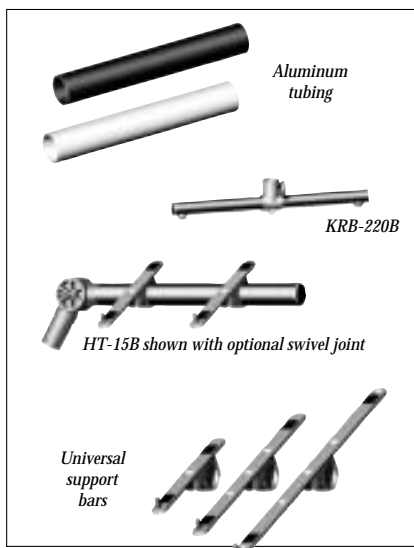

Single T-Frame Leg System

KRB-220B - Base - 22" wide **24.95**

Single A-Frame Leg System

CM-12BS - 42" leg. Comes with one pivot fitting and leg brace..... **Call**

Half-Tier HT-15B

The HT-15B half-tier holds smaller gear off to the side of the stand. It includes one T-fitting and two short Support bars. It has a load capacity of 15 lbs..... **24.95**

Universal Support Bars

Includes a universal fitting and rubber pads.

- USB-160** - Short (8") **9.95**
- USB-220B** - Standard (14") **12.95**
- USB-222** - Long (20") **14.95**



For Any Inquiries Regarding Your Order, Call Our Customer Service:
(800) 221-5743 • (212) 239-7765 • FAX: (800) 947-2215 • (212) 239-7549

KEYBOARD *and* HOME STUDIO STANDS

THINKERTOYS



Bracing

Aluminum flatbar with universal fittings.

BRC-140B - 1" flatbar; 14" long**12.95**

BRC-190B - 5/8" flatbar; 19" long**12.95**

End Caps, End Plugs

Support Tiers offer added stability. Tiers come with two T-fittings.



FCP-150 - Foot cap for 1 1/2" tubing**95**

ECP-150 - End cap for 1 1/2" tubing**50**

ECP-162 - End cap for 1 1/2" tubing**2.00**

ELP-150 - End plug for 1 1/2" tubing**50**

ECP-151 - End plug for thick-walled 1 1/2" tubing**50**

ECP-162 - End plug for 1 1/2" tubing**50**

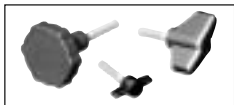

Fasteners

For use with T-fittings and collars.

TSS-150 - T-screw and spacer, 1/4-20 ...**1.00**

ZKB-175 - 1.75" length handknob with washer. Use on TS-80/88 stands**3.50**

ZKB-137 - 1.37" length handknob with washer**3.50**

HEX-100 - Hex nut, 1/4-20**20**

SHS-100 - Socket screw, 1", 1/4-20**20**

Tools

BAL-100 Ball driver 3/16 **Call**

CUT-100 Tubing cutter **Call**

AWR-316 Allen wrench 3/16 **1.00**

Boom Jointers

Connects two standard tubes in line.

BJR-150B Black color ..**17.50**

BJR-150 Silver color**16.00**

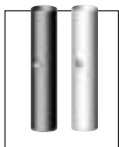

CLA-200

Clip Assembly

The CLA-200 holds notes, sheet music, etc. Mounts on 1 1/2" tubing**70.00**

CSB-180 Computer Support Bar

Attaches to horizontal tiers, extending forward from the underside of the tier. Holds computer keypads. Sold as single bar (12 1/4")**10.00**

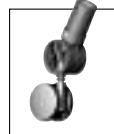

CST-150 Caster Assembly with Swivel Mounts in the end of standard tubing where adjustable eangles of the

caster are desired**24.95**

EXT-222 Pin Extension Pair

Slide over existing support bar pins for securing front slanted instruments **Call**

Microphone Mounts

MIC-150 - Microphone End Mount. Adapter mounts mic booms or goosenecks to the end of standard tubing**19.95**



MTM-587 - Microphone T-Mount. Adapter mounts mic booms or goosenecks along a standard tube**24.95**

PVF-150

Connect two tubes at various angles**8.00**

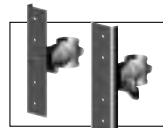

Rack Rail Pairs

For mounting standard 19" rack equipment. hardware included.

RL-05B - 5 space rack rail pair **Call**

RL-10B - 10 space rack rail pair **Call**

Shelves

Lightweight black polymer shelves support smaller equipment on keyboard tiers.



SHF-185 - 13 1/2 x 18 1/2"**34.95**

SHF-415 - 13 1/2 x 41 1/2"**56.00**

Swivel Joints

SJI-150 - Swivel joint, tube-to-tube. Forms an adjustable joint between two 1 1/2" tubes**29.95**

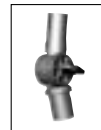
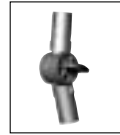

SJT-150 - Swivel joint, tube-to-fitting. Extends a half-tier to the side of an A-Frame stand. Regardless of position, the SJT-150 keeps the

HT-15B on a horizontal plane**24.95**

Velcro

VCA-100 - Adhesive velcro-hook (per foot) **Call**

VCA-200 - Adhesive velcro-loop (per foot) **Call**

VCS-712 - Velsro strap pair. Used for cord control **4.00**

TCR-150 Telescoping Collar

Used to telescope 1 1/2" standard tubing out of a 1 1/2" tube**6.00**



TFG-150 T-Fitting

Forms a rigid 90° joint between two standard 1 1/2" tubes**5.00**

HTG-150

Hatched T-Fitting

Two-piece T-fitting is strong and convenient for adding items to existing stands**6.00**

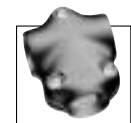

Adjustable T-Fitting

Set any angle in 7.5° increments.

ATG-150 - For 1 1/2" tubing**14.95**

ATG-133 - For 1 1/2" and 1 1/4" tubing**14.95**

ATG-125 - For 1 1/4" tubing**14.95**

UNF-150

Universal Fitting

Used to attach flatbar to standard tubing**4.00**

