

COBY®



MP815

EN

**2.8" Widescreen Video MP3 Player
Instruction ManualPage 2**

Please read carefully before use

Table of Contents

PACKAGE CONTENTS	4
FEATURES	5
GETTING STARTED	6
Controls at a Glance	6
Disabling the Controls (Hold).....	8
Charging the Battery	8
Charging with a Computer.....	9
Turning the Player On/Off.....	9
Resetting the Player.....	9
Using the Controls to Navigate	10
MAIN MENU	11
Main Menu Controls	11
Music Browser Controls.....	12
Now Playing Controls (Music Playback)	13
Quick Option Menu.....	14
PHOTO MODE	17
Photo Browser Controls.....	17
Photo Viewer Controls	18
Quick Option Menu.....	18
VIDEO MODE	20
Video Browser Controls.....	20
Video Playback Controls	20
Quick Option Menu.....	21
RADIO MODE	22
Radio Tuning Controls.....	22
Quick Option Menu.....	23

Table of Contents

TEXT MODE	25
Text Browser Controls	25
Text Reader Controls	26
Quick Option Menu.....	26
EXPLORER MODE.....	28
Explorer Controls	28
SETUP MODE.....	29
TRANSFERRING FILES TO THE PLAYER.....	32
Connecting to a Computer	32
Transferring Files.....	32
Microsoft Windows	34
Macintosh OS X.....	34
Disconnecting from a Computer.....	35
Microsoft Windows	35
Macintosh OS X.....	36
VIDEO CONVERSION	37
FIRMWARE UPGRADES	38
TROUBLESHOOTING	39
SPECIFICATIONS.....	42

Package Contents

English

Please make sure that the items shown below are included in the package. Should an item be missing, please contact the local retailer from which you purchased this product.

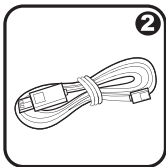

1. COBY MP3 Player
2. USB Cable
3. Instruction Manual & Documentation
4. Professional Stereo Earphones

Features

- ✦ Integrated flash memory
- ✦ 2.8" TFT LCD full-color display
- ✦ Plays music, video, photos and text
- ✦ Plays Digital Music from most online stores and subscription services*
- ✦ ID3 and LRC support for song and synchronized lyric information display
- ✦ Integrated FM radio
- ✦ USB 2.0 Hi-speed for fast file transfers

** Music Service must support Windows Media DRM (WMDRM). WM-DRM10 requires Windows XP and Windows Media Player 10 or newer.*



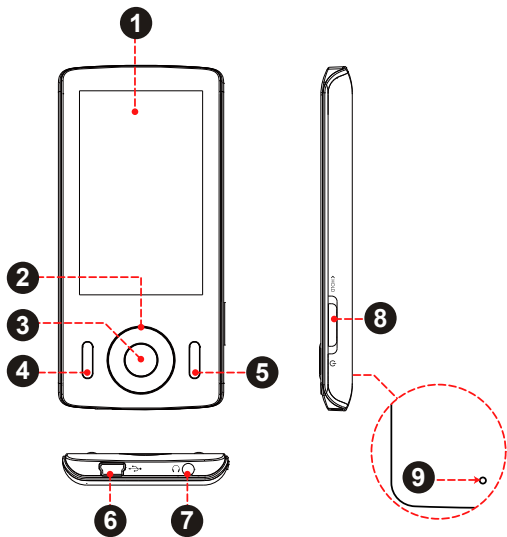

Getting Started

Controls at a Glance

English



Getting Started

Front View		
1. LCD Display		
2. Control Buttons		<UP>
		<DOWN>
		<LEFT>
		<RIGHT>
3. Enter Button		<ENTER>
4. Menu Button		<MENU>
5. Option Button		<OPTION>
Bottom View		
6. USB/Charge Port		
7. 3.5mm Headphone Jack		
Side View		
8. Power / Hold Switch <i>Slide and hold the switch down for Power.</i> <i>Slide the switch up for Hold.</i>		<POWER>
Rear View		
9. Reset Button		<RESET>

Getting Started

Disabling the Controls (Hold)

When the <POWER> switch is set to the “Hold” position, your player’s controls are disabled.

1. To disable the controls, slide the <POWER> switch up until it clicks into the “Hold” position.
2. To enable the controls, slide the <POWER> switch down to release it from the “Hold” position.



You may want to disable the controls to avoid turning on the player or activating the controls accidentally when it is in your pocket or bag.

A lock icon will appear on the screen when the controls are disabled. Re-enable the controls to continue.

Charging the Battery

Your player has an integrated rechargeable battery. Upon initial use, the battery should be charged fully to ensure optimal performance and battery life.

If the player has not been used in a while, the battery may need to be recharged overnight (about 8 hours).



The battery used in this device may present a fire or chemical burn if mistreated. Do not disassemble, incinerate, or heat the battery. Do not leave the battery in a place subject to direct sunlight, or in a car with its windows closed.

Do not connect the player to a power source other than that which is indicated here or on the label as this may result in the risk of fire or electric shock.

Getting Started

Charging with a Computer

Your player can be charged through a USB computer connection. Use the supplied USB cable to connect the player to a high-power USB port of a computer. The computer must be powered on and not in sleep mode.



When the player is connected and charging, a USB symbol will be displayed on the player's screen.

Turning the Player On/Off

- ✦ To turn the player on, slide the <POWER> switch down and hold it until the screen turns on.
- ✦ To turn the player off, slide the <POWER> switch down and hold it until the screen turns off.

Resetting the Player

Reset the player if it should freeze and not respond or otherwise malfunction.

1. Disconnect your player if it is connected to a computer.
2. Use a paper clip to gently press the <RESET> button located on the rear of the player.

Getting Started

Using the Controls to Navigate

English

To navigate through the different menu options and files on your player:

- ✦ Press the Arrow keys to move the selection in the direction of the arrow.
 - ✧ <UP> Move the selection up.
 - ✧ <DOWN> Move the selection down.
 - ✧ <RIGHT> Move the selection right.
 - ✧ <LEFT> Move the selection left.
- ✦ Press <ENTER> to confirm a selection.
- ✦ Press <LEFT> to return to the previous screen.

Main Menu

When you turn on the player, you will see the Main menu. The Main menu gives you access to the different function modes of your player. These modes are:

- Music: Browse and play music.
- Photo: Browse and view pictures.
- Video: Browse and play movies.
- Radio: Listen to FM radio broadcasts.
- Text: Browse and read text files.
- Explorer: Browse all files.
- Setup: Adjust the player's options.

Main Menu Controls

- ✦ To browse through the different modes, press <UP> or <DOWN>.
- ✦ To select a mode, press <ENTER>.



To return to the main menu at any time, press and hold <MENU>.

Music Mode

Browse for and play your music files

If you have loaded new music files onto the player, the music library will need to be updated when you enter Music mode. This process may take several minutes.



You will not be able to access the Music Browser screen until you refresh the music library.

For more information about how to get music onto your player, please refer to the section "Transferring Files to the Player".

Music Browser Controls

When you choose MUSIC mode from the Main menu, you will see the Music Browser screen. You can choose to browse your music by category or all at once, or you may choose "Folder Explorer" to view the music files and folders on the player.

Function	Key Action
To browse through the list	Press <UP> or <DOWN>
To select an item	Press <ENTER>
To add a song to the Favorite list	Press <OPTION>
To return to the previous screen	Press <MENU>



If your music files contain ID3 song information tags, you will be able to view your tracks by Artist, Album, or Genre. To view all files (including those without ID3 tags), select "All Music" or "Folder Explorer".

If music is already playing, you will have the additional option to return to the "Now Playing" screen.

Music Mode

Now Playing Controls (Music Playback)

To start playing music, browse for a song and then press <ENTER> to start playback.

When a song is playing, the Now Playing screen appears (see below).

English



The following functions may be performed from the Now Playing screen:

Music Mode

Function	Key Action
To play the next track	Press <RIGHT>
To play the previous track	Press <LEFT>
To forward-scan quickly through the current track	Hold <RIGHT>
To reverse-scan quickly through the current track	Hold <LEFT>
To pause/resume playback	Press <ENTER>
To access the Quick Option menu (see below for details)	Press <OPTION>
To adjust the volume level	Press <UP> or <DOWN>
To return to the Music Browser screen	Press <LEFT>

Quick Option Menu

To access the quick option menu, press <OPTION> on the Now Playing screen.

- ✦ To browse through the settings, press <UP> or <DOWN>
- ✦ To select a setting, press <ENTER>
- ✦ To return to the previous screen, press <LEFT>

Music Mode

Repeat Mode

Adjust the Repeat settings to change the repeat options.

Item	Description
Normal	Play all tracks once.
Repeat 1	Play the current track once.
Repeat All	Play all tracks repeatedly.
Random	Play tracks in random order (shuffle).
Intro	Play the first 10 seconds of all tracks.

Add to Favorite

You can make a play list of your favorite music by adding songs to the Favorite list. To add a song to the Favorite list:

1. Select "All Music" from the Music Browser screen.
2. Use the Browser controls to select a song to add.
3. Press <OPTION>. The screen will display "Add to Favorite".
4. Press <ENTER> to finish adding the song to the My Favorite List.



To play the Favorites list, select "Favorites" from the Music Browser menu.

Music Mode

Equalizer

Select a digital equalizer preset.

- ✦ The PlayFx has 3 options: 3D, Bass, and LEQ (Auto Volume: consistent volume level respectively).
- ✦ User EQ Setup:
 1. Press <LEFT> or <RIGHT> to select a band to adjust.
 2. Press <UP> to increase the selected band level; Press <DOWN> to decrease the level.
 3. Press <ENTER> when you are finished to save.



Select the bands to the left to adjust low (bass) frequencies; select the bands in the middle to adjust mid frequencies; select the bands to the right to adjust high frequencies (treble).

Lyric

Turn music lyric display on or off.



Lyric display requires a ".LRC" lyric file which may be found on the internet or may be created with a Lyric file editor. Lyric files can contain synchronized timing information as well as lyric information.

Lyric files must have the same name as its corresponding music file (e.g., "SongTitle1.lrc" and "SongTitle1.mp3") and must be placed in the same directory.

Photo Mode

Browse for and view your photo files.



For more information about how to get photos onto your player, please refer to the section "Transferring Files to the Player".

English

Photo Browser Controls

When you choose PHOTO mode from the Main menu, you will see the Photo Browser screen. Your photos will be displayed as thumbnail images.

Use the Photo Browser to find all photo files loaded on your player.

Function	Key Action
To browse through the photos & folders	Press <UP>, <DOWN>, <LEFT>, <RIGHT>
To select/view an item	Press <ENTER>
To return to the previous screen	Select <  > and then press <ENTER>



You may also press <OPTION> to return to the previous screen.

Photo Mode

Photo Viewer Controls

To view a photo, browse through the thumbnail photos and then press <ENTER>.

The following functions may be performed from the Photo Viewer screen.

Function	Key Action
To view the next photo	Press <RIGHT>
To view the previous photo	Press <LEFT>
To rotate the photo clockwise	Press <UP>
To rotate the photo counter-clockwise	Press <DOWN>
To access the Quick Option Menu	Press <OPTION>
To return to the Photo Browser screen	Press <MENU>

Quick Option Menu

To access the quick option menu, press <OPTION> on the Photo Viewer screen.

- ✦ To browse through the settings, press <UP> or <DOWN>
- ✦ To select a setting, press <ENTER>

Slide Show

Turn slideshow mode on or off.

Photo Mode

Show Time

Set the amount of time between pictures during slide-show mode (in seconds).

Brightness

Adjust the brightness of the screen.

Zoom In / Zoom Out

- ✦ Select Zoom In to increase the magnification level of the photo.
 - ✧ Use the control keys (left/right/up/down) to pan around the magnified image.
 - ✧ Press <MENU> to return to normal view.
- ✦ Select Zoom Out to decrease the magnification level of the photo.
 - ✧ Press <MENU> to return to normal view.



The Zoom In/Out function works for JPEG photo files, only.

Video Mode

Browse for and play your video files.



Your player supports AVI, RM, RMVB, WMV and FLV video files. Please refer to the Specifications section for details.

It may be necessary to use the included Coby Media Manager software to convert video for playback on the MP815.

For more information about how to get videos onto your player, please refer to the section "Transferring Files to the Player".

Video Browser Controls

When you choose VIDEO mode from the Main menu, you will see the Video Browser screen.

Use the Video Browser to find all video files loaded on your player.

Function	Key Action
To browse through the list of video files & folders	Press <UP> or <DOWN>
To select/play an item	Press <ENTER>
To return to the previous screen	Press <LEFT>

Video Playback Controls

When a video is playing, hold the player horizontally (landscape). The orientation of the controls will change accordingly.

Video Mode

Use the following controls during video playback; *the name of the controls are given as if you were holding the player horizontally.*

Function	Key Action
To play the next video	Press <RIGHT>
To play the previous video	Press <LEFT>
To scan quickly through the current video (forward or reverse)	Hold <RIGHT> or <LEFT>
To pause/resume playback	Press <ENTER>
To adjust the volume level	Press <UP> or <DOWN>
To view file information on screen	Press <OPTION> once
To access the Quick Option menu	Press <OPTION> twice
To return to the Video Browser screen	Press <MENU>
To return to the Main menu	Hold <MENU>

Quick Option Menu

To access the quick option menu, press <OPTION> twice during video playback.

Full Screen / Normal

Press <LEFT> or <RIGHT> to toggle full screen view on/off.

Brightness

Press <LEFT> or <RIGHT> to toggle full screen view on/off.

Radio Mode

Listen to FM radio broadcasts.



You must have a pair of headphones connected to the headphone jack to receive FM broadcasts; your player will utilize the headphone cord as an antenna.

Radio Tuning Controls

When you choose RADIO from the Main menu, you will see the Radio Tuning screen. You can search for stations, tune to stations manually, or tune to preset stations.



You must have saved preset stations prior to using preset tuning mode.

The following functions may be performed from the Radio Tuning screen.

Function	Key Action
To tune to a higher station	Press <RIGHT>
To tune to a lower station	Press <LEFT>
To scan to the next highest station (manual mode only)	Hold <RIGHT>
To scan to the next lowest station (manual mode only)	Hold <LEFT>
To access the Quick Option Menu.	Press <OPTION>

Radio Mode

Quick Option Menu

To access the quick option menu, press <OPTION> on the FM Listening screen.

- ✦ To browse through the settings, press <UP> or <DOWN>.
- ✦ To select a setting, press <ENTER>.

Manual (or Preset) Mode

Set the FM Tuning mode to Manual or Preset.

Save channel

Save the current station to the Preset Station list.

- ✦ Select an "Empty" slot to save the station as a new preset.
- ✦ Select an existing slot to overwrite the preset.

Delete channel

Delete station(s) from the Preset Station list.

1. Press <UP> or <DOWN> to select a Preset Station and press <ENTER> to delete. A warning screen will appear.
2. Select "YES" and press <ENTER> to confirm deletion.

Radio Mode

Auto Presetting

Scan for all stations in broadcast reception range. The player will automatically seek and save all frequencies with a broadcast signal to the Preset Station list.



The auto scan feature will overwrite any previously stored Preset Stations.

Sensitivity

Set the sensitivity of Auto-Scan feature.

Force Mono

Set the stereo reception on or off.

Area

Set the FM frequency range (USA, Europe, Japan).

Text Mode

Read text files loaded on your player (TXT).



For more information about how to get text files onto your player, please refer to the section "Transferring Files to the Player".

Text Browser Controls

When you choose TEXT from the Main menu, you will see the Text Browser Screen.

Use the Text Browser to find all text files loaded on your player.

Function	Key Action
To browse through the list of text files & folders	Press <UP> or <DOWN>
To select/view an item	Press <ENTER>
To return to the previous screen	Press <LEFT>
To return to the Main menu	Hold <MENU>

Text Mode

Text Reader Controls

When reading a text file, hold the player horizontally (landscape). The orientation of the controls will change accordingly.

Use the following controls to read text; *the name of the controls are given as if you were holding the player horizontally.*

Function	Key Action
To read the next line	Press <DOWN>
To read the next page	Press <RIGHT>
To read the previous line	Press <UP>
To read the previous page	Press <LEFT>
To access the Quick Option Menu.	Press <OPTION>
To return to the Text Browser screen	Press <MENU>
To return to the Main menu	Hold <MENU>

Quick Option Menu

The Quick Option menu gives you easy access to your player's option settings.

Press <OPTION> to access the Quick Option menu.

Goto Page

Skip to a page directly.

✦ Press <LEFT> or <RIGHT> to select a field to adjust.

Text Mode

- ✦ Press <UP> or <DOWN> to adjust the selected field.
- ✦ Press <ENTER> to confirm.

Bookmark

The options are: Save Bookmark, Load Bookmark, and Delete Bookmark.

- ✦ Save Bookmark: Save the current location as a bookmark.
- ✦ Load Bookmark: Open (go to) a saved bookmark.
- ✦ Delete Bookmark: Delete a saved bookmark.
 - ✧ Press <UP> or <DOWN> to select a number and press <ENTER> to confirm.

Set Font Size

Set the font size of the text display.

Set Font Color

Set the text color of the display.

Auto Scroll

Set the auto page scroll on or off.

Auto Scroll Time

Press <UP> or <DOWN> to adjust the amount of time between pages during Auto Scroll mode.



You can override the auto-scroll function by pressing <DOWN> or <UP> at any time.

Explorer Mode

Enter Explorer mode to view and delete folders and files loaded on your player.

To enter Explorer mode, select and confirm EXPLORER from the Main Menu.

If a compatible file is selected and confirmed, the file will be played in its corresponding mode.

- ✦ Music Mode: MP3, WMA, OGG
- ✦ Video Mode: AVI, WMV, FLV, RM, RMVB
- ✦ Photo Mode: JPG, BMP, GIF
- ✦ EBook Mode: TXT, LRC

Explorer Controls

When you choose EXPLORER mode from the Main menu, you will see the File Explorer screen. You can find and delete files or folders from the player.

- ✦ Press <UP> to move the selection up; press <DOWN> to move the selection down.
- ✦ Press <ENTER> to confirm a selection.
 - ✧ If a folder has been selected, the contents of the folder will be displayed.
 - ✧ If a compatible file has been selected, the file will be played in its corresponding mode.
- ✦ Press <LEFT> to cancel a screen and return to the previous folder.

Setup Mode

Enter the Setup mode to set your player's system options.

To enter Settings mode, select SETUP in the Main menu.

Function	Key Action
To browse through the options	Press <UP> or <DOWN>
To select an item	Press <ENTER>
To cancel and return to the previous screen	Press <LEFT>
To return to the Main menu	Hold <MENU>

The following options are available. Some of these options may be set from the Quick Option menus.

Item	Description
Display Setting	
Backlight	Adjust the duration of time (in seconds) that the backlight will remain on after a key press. A setting of "Always On" will keep the backlight on continuously.
Brightness	Adjust the brightness of the screen.
Timer	
Sleep	Set a sleep timer to turn the player off automatically.

Setup Mode

Item	Description
Date/ Clock	<p>Set the internal date and time of the player.</p> <ul style="list-style-type: none">• Press <LEFT> or <RIGHT> to select a field to adjust.• Press <UP> or <DOWN> to adjust the selected field.• Press <ENTER> to finish and save, or press <OPTION> to cancel without saving.
Language	
--	Set the language that the on-screen menus appear in.
System	
Auto Play	Set the Auto Play function on or off. If you set the function on, the player will resume playback automatically once you power it on.
USB Mode	<p>Set the USB connection mode (MSC or MTP) when connecting the player to a computer.</p> <ul style="list-style-type: none">• MSC. This setting enables the widest compatibility with all systems, and allows the player to be used as a removable storage device.• MTP: The player will utilize an MTP connection if it is available. The MTP connection mode enables advanced synchronization features with Windows Media Player 10 (WMP10) or newer. If an MTP connection is not available, the player will revert to MSC.

Setup Mode

Item	Description
Load Default	Restore all of the player's settings to their factory-default state.
Information	View Firmware & Memory Usage information. <ul style="list-style-type: none">• Press <LEFT> to exit.

Transferring Files to the Player

Connecting to a Computer

Connect the Coby player to a computer with the USB 2.0 cable provided to:

- ✦ Transfer files to and from your player.
- ✦ Perform basic file management functions.



Upon connection:

- ✦ Your computer will automatically recognize the player as an MTP Device (if possible). An icon representing your player will appear under "Audio Devices" when you open "My Computer".
- ✦ It may take Windows several minutes to recognize and set up the device the first time it is connected depending on your hardware configuration. If you need further assistance with transferring files, please refer to your operating system's instruction manual or on-screen help.

Transferring Files

The USB 2.0 Hi-Speed connection makes it easy to transfer music, video, photo, and text files (or any other data) quickly between the player and your computer. Simply use the

Transferring Files to the Player

player as you would a floppy disk using basic operating system commands.

If you need further assistance with transferring files, please refer to your operating system's instruction manual or on-screen help. If you are using media management software such as Coby Media Manager, Windows Media Player, iTunes or Winamp, please refer to their documentation for support.

English



Do not disconnect or otherwise interrupt the player during transmission—this could damage or corrupt the player's firmware or your files. If the player is accidentally disconnected and is not working properly, try resetting the player.



Content owners use Windows Media digital rights management technology (WMDRM) to protect their intellectual property, including copyrights. This device uses WMDRM software to access WM-DRM-protected content. If the WMDRM software fails to protect the content, content owners may ask Microsoft to revoke the software's ability to use WMDRM to play or copy protected content. Revocation does not affect unprotected content. When you download licenses for protected content, you agree that Microsoft may include a revocation list with the licenses. Content owners may require you to upgrade WMDRM to access their content. If you decline an upgrade, you will not be able to access content that requires the upgrade.

Transferring Files to the Player

Microsoft Windows

1. Double-click the "My Computer" icon on your desktop and then double-click the icon that represents your Coby player (e.g., MP815) (MTP Multimedia Player).
2. Your player contains two folders: Data and Media.
 - ✧ Drag your media files to the Media folder (e.g., MP3, WMA files).
 - ✧ Drag all other types of files to the Data folder for storage. Data files are only visible from a computer; these files will not be available from within the player itself.

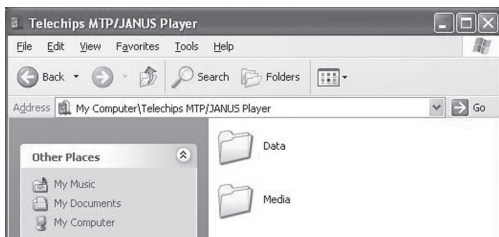

Macintosh OS X

1. Open a finder window. Located the files you would like to transfer from your computer. Select the files/folders with the mouse and press APPLE-C (copy) on the keyboard.

Transferring Files to the Player

2. Click on the Removable Disk icon located on the left side of the finder window. The computer will display all files and folders currently stored in the player.
3. Press APPLE-V (paste) on the keyboard to transfer the files you selected in Step 1 to the player.

Disconnecting from a Computer

To avoid data loss or file/firmware corruption, disconnect the player as instructed below or as by your specific operating system.

Microsoft Windows

1. Double-click the green arrow in the taskbar located on the lower-right side of the computer screen (Safely Remove Hardware).



2. **Safely Remove Hardware:**
Select "USB Mass Storage Device" from the list that appears and then click on "Stop".

Stop a Hardware Device: Select "USB Mass Storage Device" from the list that appears and then click on "OK".

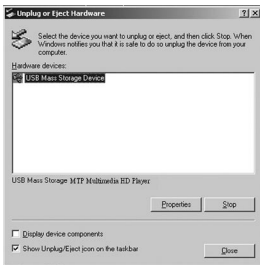

Transferring Files to the Player

3. When the “Safe to Remove Hardware” window appears, click the OK button and disconnect the USB cable from the player and your computer.

Macintosh OS X

1. On the left side of the Finder Window, identify the appropriate Removable Disk icon.A screenshot of a Mac OS X Finder window. The window title bar is blue and contains the text 'USB Disk' and an eject icon on the right. Below the title bar, there are two icons: a blue icon with a white 'D' representing a 'Desktop' folder, and a blue icon with a white 'D' representing a 'Desktop' folder. The text 'Desktop' is visible below the second icon.
2. Click on the “Eject” arrow on the right of the Removable Disk icon.
3. Disconnect the USB cable from the player and your computer.

Video Conversion

For movie and music synchronisation and conversion, please use Coby Media Manager software loaded on your player. The manual is included on your player also.

English

Firmware Upgrades

From time to time, COBY may release firmware upgrades to improve the performance of the Player or to add additional features. Please check the COBY website periodically at www.cobyusa.com to see if new firmware has been released for your player. If you are experiencing abnormal behavior with your player, you may choose to restore (format) your player before updating its firmware.



Do not interrupt the firmware upgrade process—doing so could damage your player and render it inoperable. See the documentation that is included with the firmware upgrade file for detailed instructions.

Troubleshooting

If you have a problem with this device, please read the troubleshooting guide below and check our website at www.cobyusa.com for Frequently Asked Questions (FAQs) and firmware updates. If these resources do not resolve the problem, please contact Technical Support.

English

Address

Coby Electronics Technical Support
56-65 Rust Street
Maspeth, NY 11378

Email

techsupport@cobyusa.com

Web

www.cobyusa.com

Phone

800-727-3592: Mon–Fri, 8:00AM–11:00PM EST
Saturday, 9:00AM–5:30PM EST
718-416-3197: Mon–Fri, 8:00AM–5:30PM EST



For your safety, never attempt to repair the device yourself. Attempting to do so will invalidate the warranty. Internal components of the device carry a risk of electric shock.

The player does not turn on.

- ✦ Ensure that the player is fully charged. Try charging the player overnight (8 hours).
- ✦ Reset the player (use a paper clip to gently press the Reset button on the rear of the player) and try again.

Troubleshooting

The buttons do not work.

- ✦ Ensure that the Hold switch is disengaged.
- ✦ Reset the player (use a paper clip to gently press the Reset button on the rear of the player) and try again.

I cannot transfer files to the player.

- ✦ Ensure that your computer is running a supported operating system.
- ✦ If using a USB extension cable, ensure that it is securely attached to the player and the PC, or try using another USB cable.
- ✦ If you have connected the player through a USB hub, try connecting the player directly to your computer.
- ✦ Ensure that the player's memory capacity is not full.
- ✦ Ensure that the Hold switch is disengaged.

There is no sound during playback.

- ✦ Check the volume level.
- ✦ Ensure that the headphones are attached securely to the player.

The sound quality of the music is poor.

- ✦ Try playing the file on your computer. If the sound quality is still poor, try downloading the file again or re-encoding the file yourself.

Troubleshooting

- ✦ Ensure that the bit rate of the file is not too low. The higher the bit rate of the file, the better it will sound. The minimum recommended bitrate is 128kbps for MP3s and 96kbps for WMAs.
- ✦ Try lowering the volume of the player.
- ✦ Ensure that the headphones are attached securely to the player.

The player will not play my music file.

- ✦ Ensure that the file is in a compatible format.
- ✦ The file may be copy-protected and you no longer have authorization to play this file. If you feel this is in error, please contact the service from which you downloaded the file.

The LCD characters are corrupted or something is wrong with the display.

- ✦ Ensure that the correct menu language has been set.
- ✦ Reset the player (use a paper clip to gently press the Reset button on the rear of the player) and try again.

The player has malfunctioned.

- ✦ Reset the player (use a paper clip to gently press the Reset button on the rear of the player) and try again.
- ✦ Try updating the player's firmware. Please refer to the [Firmware Upgrades](#) section of this manual for instructions.

Specifications

Display Type	2.8" TFT Full-Color LCD @ 400x240
Memory	MP815-4G: 4GB Flash MP815-8G: 8GB Flash MP815-16G: 16GB Flash
Audio Format Support	MP3, WMA, OGG, APE
Video Format Support	AVI, WMV, RMVB, FLV
Photo Format Support	JPG, BMP, GIF
DRM Support	WM-DRM10
Song Info Support	ID3, Windows Media
FM Frequency Range	87.5 - 108.0MHz
PC Interface	USB 2.0 Hi-Speed (MSC/MTP)
Plug and Play Support	Windows 2000/XP/Vista Macintosh OS X
Audio Output	3.5mm Stereo (Headphone)
Power Supply	Rechargeable Lithium-Polymer Battery USB Charge
Play Time	Music: 8 hours*
Unit Dimensions	1.88" x 4.13" x 0.41" (WHD)

Specifications and manual are subject to change without notice.

** Music play time is an estimated value based on playing an MP3 encoded at 128 kbps. Actual play time may vary depending on encoding method used and other factors.*

Coby Electronics Corporation

1991 Marcus Ave, Suite 301
Lake Success, NY 11042

www.cobyusa.com

www.ecoby.com

IB v1.0

FW: 2.2.3-20090218

Coby is a registered trademark of Coby Electronics Corporation. Printed in China.

COBY es la marca registrada de COBY Electronics Corporation. Imprimido en China.

Coby est une marque de fabrique de Coby Electronics Corporation. Imprimé en Chine.