

The Samsung logo is located in the top left corner of the blue cover. It consists of the word "SAMSUNG" in a bold, white, sans-serif font, enclosed within a white oval shape.

User Manual

L310W

Thank you for buying a Samsung Camera. This manual will guide you through using the camera, including capturing images, downloading images and using the application software. Please read this manual carefully before using your new camera.

Instructions

Use this camera in the following order.

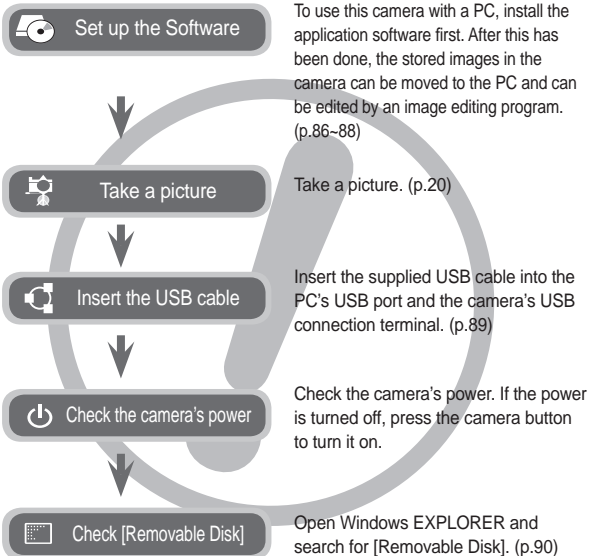

Getting to know your camera

Thank you for buying a Samsung Digital Camera.

- Prior to using this camera, please read the user manual thoroughly.
 - If you require After Sales service, please bring the camera and the cause of the camera malfunction (such as battery, Memory card etc.) to the A/S centre.
 - Please check that the camera is operating properly prior to when you intend to use it (e.g. for a trip or an important event) to avoid disappointment. Samsung takes no responsibility for any loss or damage that may result from camera malfunction.
 - Keep the manual in a safe place.
 - The contents and illustrations in this manual are subject to change without prior notice for upgrading the camera functions.
 - If you use a card reader to copy the images on the memory card to your PC, the images could be damaged. When transferring the images taken with the camera to your PC, be sure to use the supplied USB cable to connect the camera to your PC. Please note that the manufacturer accepts no responsibility for loss or damage of images on the memory card due to the use of a card reader.
- × Microsoft, Windows and Windows logo are registered trademarks of Microsoft Corporation incorporated in the United States and/or other countries.
- × All brand and product names appearing in this manual are registered trademarks of their respective companies.

DANGER

DANGER indicates an imminently hazardous situation which, if not avoided, will result in death or serious injury.

- Do not attempt to modify this camera in any way. This may result in fire, injury, electric shock or severe damage to you or your camera. Internal inspection, maintenance and repairs should be carried out by your dealer or Samsung Camera Service centre.
- Please do not use this product in close proximity to flammable or explosive gases, as this could increase the risk of explosion.
- Should any form of liquid or a foreign object enter the camera, do not use it. Switch off the camera, and then disconnect the power source. You must contact your dealer or Samsung Camera Service centre. Do not continue to use the camera as this may cause a fire or electric shock.
- Do not insert or drop metallic or inflammable foreign objects into the camera through access points e.g. the memory card slot and battery chamber. This may cause a fire or electric shock.
- Do not operate this camera with wet hands. This could pose a risk of electric shock.

WARNING

WARNING indicates a potentially hazardous situation which, if not avoided, could result in death or serious injury.

- Do not use the flash in close proximity to people or animals. Positioning the flash too close to your subject's eyes may cause eyesight damage.
- For safety reasons keep this product and accessories out of reach of children or animals to prevent accidents e.g.:
 - Swallowing battery or small camera accessories. If an accident should occur, please consult a doctor immediately.
 - There is the possibility of injury from the camera's moving parts.
- Battery and camera may become hot during prolonged use and it may result in camera malfunction. Should this be the case, allow the camera to sit idle for a few minutes to allow it time to cool.
- Do not leave this camera in places subject to extremely high temperatures, such as a sealed vehicle, direct sunlight or other places of extremes in temperature. Exposure to extreme temperatures may adversely affect the camera's internal components and could cause a fire.
- When in use, do not cover the camera or Charger. This may cause heat to build up and distort the camera body or cause a fire. Always use the camera and its accessories in a well-ventilated area.

CAUTION

CAUTION indicates a potentially hazardous situation which, if not avoided, may result in a minor or moderate injury.

- Leaking, overheating, or burst battery could result in fire or injury.
 - Use battery with the correct specification for the camera.
 - Do not short circuit, heat or dispose of battery in fire.
 - Do not insert the battery with the polarities reversed.
- Remove the battery when not planning to use the camera for a long period of time. Battery may leak corrosive electrolyte and permanently damage the camera's components.
- Do not fire the flash while it is in contact with hands or objects. Do not touch the flash after using it continuously. It may cause burns.
- Do not move the camera while it is switched on when you are using the AC Charger. After use, always switch off the camera before unplugging the cable from the wall socket. Then make sure that any connector cords or cables to other devices are disconnected before moving the camera. Failure to do so may damage the cords or cables and cause a fire or electric shock.
- Take care not to touch the lens or lens cover to avoid taking an unclear image and possibly causing camera malfunction.
- Avoid obstructing the lens or the flash when you capture an image.
- When using this camera in low temperatures, you may experience the following. These are not camera malfunctions and usually recover at normal temperature.
 - It takes longer to turn on the LCD monitor and the colour may differ from the subject.
 - When changing the composition, there may be an after image on the LCD monitor.
- Credit cards may be demagnetized if left near case. Avoid leaving magnetic strip cards near the case.
- It is highly likely to result in computer malfunctions when the 20 pin connector is connected to the USB port of a PC. Never connect the 20 pin connector to USB port of a PC.

Contents

READY

007	System chart
007	Package Contents
007	Sold Separately
008	Identification of features
008	Front & Top
009	Back
010	Bottom
010	5 Function button
012	Connecting to a power source
015	Inserting the battery
015	Inserting the memory card
016	Instructions on how to use the memory card
018	When using the camera for the first time

RECORDING

019	LCD monitor indicator
020	Starting the Recording mode
020	Selecting modes
020	How to use the Auto mode
021	How to use the Program mode
021	How to use the Manual mode
021	How to use the DUAL IS (Dual Image Stabilization) mode
022	Using the Photo Help guide mode
023	How to use the Beauty Shot mode
023	How to use the Scene modes
024	How to use the Movie clip mode
025	Recording the movie clip without sound
025	Pausing while recording a movie clip (Successive Recording)

Contents

- 026 Things to watch out for when taking pictures
- 027 Focus lock
- 027 Using the camera buttons to set the camera
- 027 POWER button
- 028 Shutter button
- 028 ZOOM W / T button
- 030 Function Description / Info / Up button
- 030 Macro / Down button
- 032 Flash / Left button
- 034 Self-timer / Right button
- 036 MENU / OK button
- 036 Fn button
 - 037 How to use the Fn menu
- 037 Fn button: Size
- 038 Fn button: Quality / Frame rate
- 038 Fn button: Metering
- 039 Fn button: Drive mode
- 039 Fn button: ISO
- 040 Fn button: White balance
- 041 Fn button: Exposure compensation
- 041 Fn button: Aperture Value
- 041 Fn button: Shutter Speed
- 042 Fn button: Movie clip frame stabiliser
- 042 E (Effect) button
- 043 E (Effect) button: Image editing
- 043 Colour
- 044 Sharpness
- 044 Contrast
- 044 Saturation
- 045 **OIS button: Optical image Stabilization**
- 045 **Using the LCD monitor to adjust the camera settings**
- 046 **Face Detection**
- 048 **Focus Area**
- 048 **ACB**
- 049 **Voice Memo**
- 049 **Voice recording**
- 050 **Recording the movie clip without voice**
- 051 **Scene mode**
- 051 **Starting play mode**
 - 051 Playing back a still image
 - 052 Playing back a movie clip
 - 052 Movie clip capture function
 - 053 On camera movie trimming
 - 053 Playing back a recorded voice
 - 054 Playing back a voice memo
- 054 **LCD monitor Indicator**
- 055 **Using the camera buttons to set the camera**
 - 055 Play mode button
 - 055 Thumbnail/ Enlargement button
- 057 **Info / Up button**
- 057 **Play & Pause / Down button**

PLAY

Contents

- 058 Left / Right / Menu / OK button
 - 058 Print button
 - 058 Delete button
 - 059 E (Effect) button: Resize
 - 060 E (Effect) button: Rotating an image
 - 060 E (Effect) button: Colour
 - 061 E (Effect) button: Image editing
 - 061 ACB
 - 061 Red eye removal
 - 062 Face Retouch
 - 062 Brightness control
 - 062 Contrast control
 - 062 Saturation control
- SETUP**
- 063 Setting up the play back function using the LCD monitor
 - 064 Starting the slide show
 - 064 Start the slide show
 - 065 Selecting Images
 - 065 Configure slide show effects
 - 066 Setting play interval
 - 066 Setting Background Music
 - 067 Playback
 - 067 Voice memo
 - 067 Protecting images
 - 068 Deleting images
 - 068 DPOF
 - 071 Copy To Card
 - 072 Sound menu
- PRINT**
- 072 Sound
 - 072 Volume
 - 072 Start up Sound
 - 073 Shutter Sound
 - 073 Beep Sound
 - 073 AF Sound
 - 073 Self Portrait
 - 074 Setup menu
 - 075 Display
 - 075 Language
 - 075 Setting up the Date / Time / Date type
 - 076 Start up image
 - 076 Display brightness
 - 076 Quick view
 - 076 Display Save
 - 077 Settings
 - 077 Formatting a memory
 - 077 Initialisation
 - 078 Recycle Bin
 - 078 File name
 - 079 Imprinting the recording date
 - 079 Auto power off
 - 080 Selecting video out type
 - 081 Auto focus lamp
 - 081 PictBridge
 - 082 PictBridge: Picture Selection
 - 083 PictBridge: Print Setting
 - 083 PictBridge: Reset

Contents

SOFTWARE	084	Software notes
	084	System requirements
	085	About the software
	086	Setting up the application software
	089	Starting PC mode
	091	Removing the removable disk
	092	Samsung Master
	095	Setting up the USB Driver for MAC
095	Using the USB Driver for MAC	
APPENDIX	096	Specifications
	098	Important notes
	100	Warning indicator
	101	Before contacting a service centre
	103	FAQ
	105	Correct Disposal of This Product
	106	Correct disposal of batteries in this product

System chart

Please check that you have the correct contents before using this product. The contents can vary depending on the sales region. To buy the optional equipment, contact your nearest Samsung dealer or Samsung service centre.

Package Contents



Camera



User manual,
Product warranty



Camera strap



AV cable



Rechargeable battery
(SLB-10A)



AC adapter (SAC-47)/
USB cable (SUC-C3)



Software CD
(see p.84-85)

Sold Separately

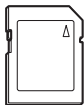

SD/SDHC memory card/
MMC (see p.17)

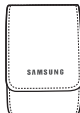

Camera case

Identification of features

Front & Top

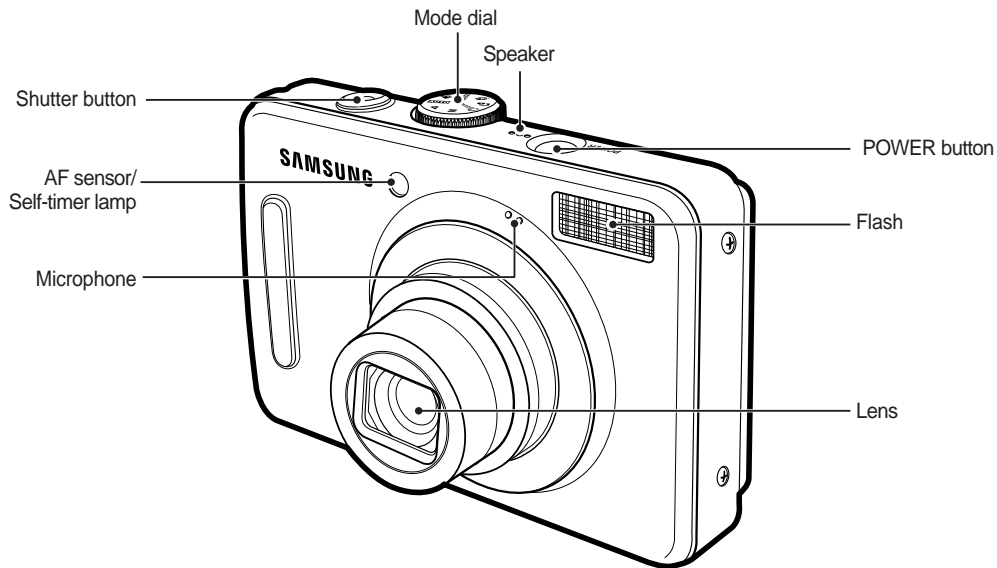

Identification of features

Back

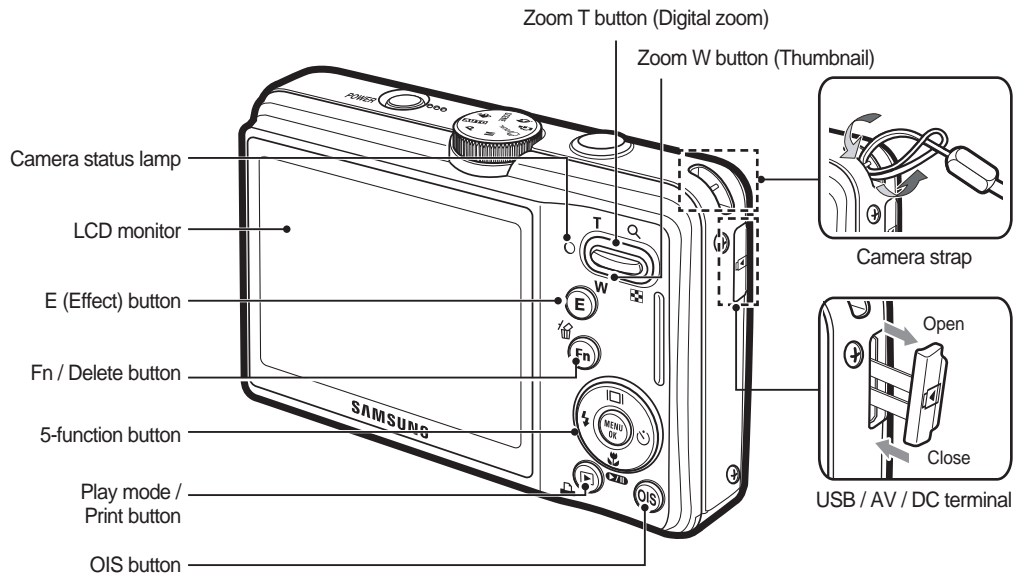

Identification of features

Bottom

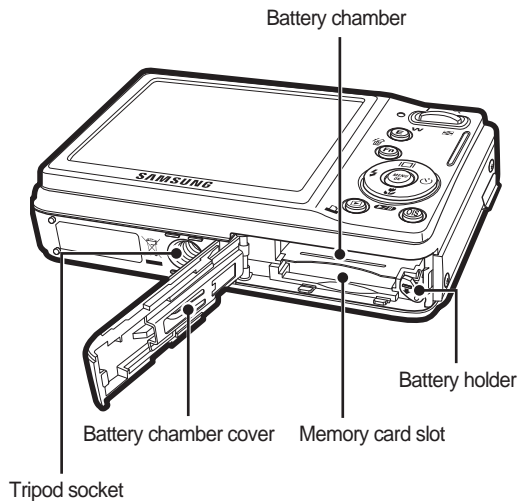

5 Function button

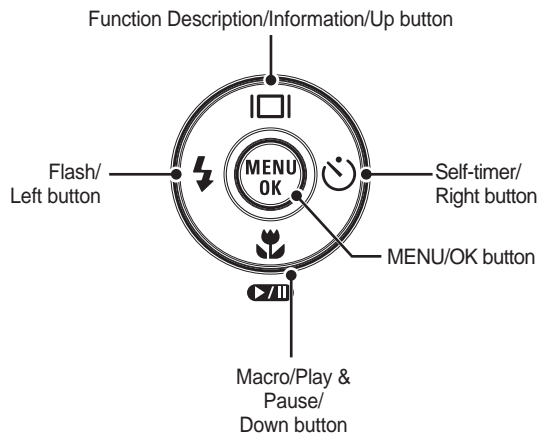

Identification of features

■ Self-timer lamp

Icon	Status	Description
	Blinking	<ul style="list-style-type: none"> For the first 8 seconds, the lamp blinks at 1 second intervals. For the final 2 seconds, the lamp blinks quickly at 0.25-second intervals.
	Blinking	For the final 2 seconds, the lamp blinks quickly at 0.25-second intervals.
	Blinking	A picture will be taken after about 10 seconds and 2 seconds later a second picture will be taken.
	Blinking	After pressing the Shutter button, the image is taken in accordance with the subject's movement.

■ Camera Status Lamp

Status	Description
Power on	The lamp turns on and off when the camera is ready to take a picture.
After taking a picture	The lamp blinks while saving the image data and turns off when the camera is ready to take another picture.
When the USB cable is inserted to a PC	The lamp lights up. (LCD monitor turns off after initializing the device)
Transmitting Data with a PC	The lamp blinks. (LCD monitor turns off)
When the USB cable is inserted to a printer	The lamp blinks and turns off when the printer is ready to print a picture.

When the printer is printing	The lamp is off.
When the AF activates	The lamp turns on. (The camera is focused on the subject)
	The lamp blinks. (The camera doesn't focus on the subject)

- **Mode icon:** Refer to page 20 for more information about the camera mode setting.

	MODE			
SHOOTING mode	Auto	Program	Manual	DUAL IS
	Photo Help Guide	Beauty Shot	Scene	Movie
			SCENE	

SCENE mode	Nightscape	Portrait	Children	Landscape
	Close up	Text	Sunset	Dawn
	Backlight	Firework	Beach&Snow	

Connecting to a power source

You should use the rechargeable battery SLB-10A supplied with the camera. Be sure to charge the battery before using the camera.

■ SLB-10A rechargeable battery Specification

Model	SLB-10A
Type	Lithium Ion
Capacity	1050mAh
Voltage	3.7V
Charging time (When the camera is turned off)	Approx. 150MIN

■ Number of images and battery life: Using the SLB-10A

	Battery life /Number of images	Conditions
Still image	Approx. 120 MIN/ Approx. 240 shots	Using the fully charged battery, Auto mode, 13M image size, Fine image quality, Shot to shot interval: 30Sec. Changing the zoom position between the Wide and the Tele after every shot. Using the flash on every second shot. Using the camera for 5 minutes and then Powering it off for 1 minute.

	Recording time	Conditions
Movie	Approx. 120 MIN	Using the fully charged battery 640x480 image size 30fps frame rate

- * These figures are measured under Samsung's standard conditions and shooting conditions and may vary depending on the user's methods.
- * These figures are measured under OIS shooting condition.



Important information about battery usage.

- When the camera is not used, turn off the camera power.
- Please remove the battery if the camera will not be used for long periods. Batteries can lose power over time and are prone to leaking if kept inside the camera.
- Low temperatures (below 0°C) can affect the performance of the battery and you may experience reduced battery life.
- Batteries will usually recover at normal temperatures.
- During extended use of the camera, the camera body may become warm. This is perfectly normal.

Connecting to a power source

You can charge the rechargeable battery (SLB-10A) by using the SAC-47 KIT which consists of the AC adapter (SAC-47) and the USB cable (SUC-C3).

When the SAC-47 and SUC-C3 are combined, they can be used as an AC cable.

- Using an AC cable:
Connect the AC adapter (SAC-47) to the USB cable.
It can be used as a power cable.

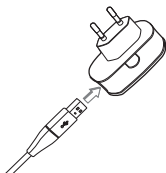

- Using a USB cable:
Remove the AC adapter (SAC-47).
You can download stored images to your PC (p.89) or supply the power to your camera through the USB cable(SUC-C3).

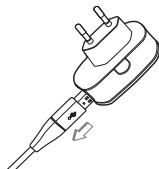

Important information about USB cable usage.

- Use a USB cable (SUC-C3) with the correct specification.
- If the camera is connected to the PC through a USB hub: connect the camera directly to the PC.
- If the camera and other devices are connected to the PC at the same time: remove other device.
- If the USB cable is connected to a port located on the front of the PC: remove the cable and connect it to a port located on the back of the PC.
- If the USB port of the PC doesn't meet the Power output standard (5V, 500mA), the camera may not be charged.

Connecting to a power source

■ How to charge the rechargeable battery (SLB-10A)

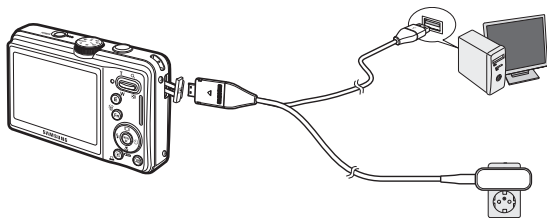

- Before inserting any cables or AC adapter, check the directions and do not insert using force. It may cause breakage of cable or camera.
- If the charging LED of the AC Charger does not turn on or blink after inserting the rechargeable battery, please check whether the battery is inserted correctly.
- If you charge the battery with the camera power on, the battery can't charge fully. Turn the camera off while charging the battery.

■ Charging LED of the AC Adapter

	Charging LED
Being Charged	Red LED is on
Charging is complete	Green LED is on
Charging error	Red LED is off or blinking
Being discharged (Using the AC adapter)	Orange coloured LED is on

- If you insert the fully discharged battery to charge it, do not turn on the camera at the same time. This is because of the low battery capacity. Charge the battery for more than 10 minutes before using the camera.
- Do not use the flash frequently or take a movie clip with the fully discharged battery charged for a short time. Even if the charger is inserted, the camera power may be turned off because the rechargeable battery is discharged again.



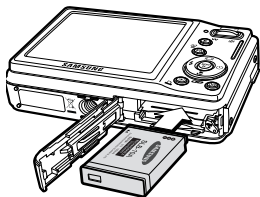

Inserting the battery

Insert the battery as shown.

- If the camera does not turn on after you have inserted battery, please check whether the battery is inserted with the correct polarity (+/-).
- When the battery chamber cover is opened, do not force it. This may cause damage to the battery chamber cover.



- There are 4 indicators for battery condition that are displayed on the LCD monitor.

Battery indicator				
Battery status	The battery is fully charged	Low battery capacity (Prepare to recharge or use spare battery)	Low battery capacity (Prepare to recharge or use spare battery)	Battery empty. Recharge or use spare battery.

Inserting the memory card

Insert the memory card as shown.

- Turn off the camera's power before inserting the memory card.
- Have the front of the memory card facing toward the back of the camera (LCD monitor) and the card pins toward the front of the camera (Lens).
- Do not insert the memory card the wrong way round. Doing so may damage the memory card slot.

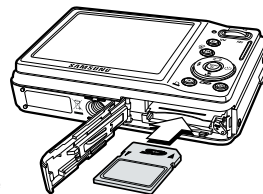

Instructions on how to use the memory card

- Be sure to format the memory card (see p.77) if you are using a newly purchased memory card for the first time, if it contains data that the camera cannot recognise, or if it contains images captured with a different camera.
- Turn off the camera power whenever the memory card is being inserted or removed.
- Repeated use of the memory card will eventually reduce the memory card's performance. Should this be the case, you will need to purchase a new memory card. Wear and tear on the memory card is not covered by the Samsung warranty.
- The memory card is an electronic precision device. Do not bend, drop or subject the memory card to any heavy impact.
- Do not store the memory card in an environment with strong electronic or magnetic fields, e.g. near loud speakers or TV receivers.
- Please do not use or store in an environment where there are extremes in temperature.
- Do not allow the memory card to become dirty or to come into contact with any liquid. Should this happen, clean the memory card with a soft cloth.
- Please keep the memory card in its case when not in use.
- During and after periods of extended use, you may notice that the memory card is warm. This is perfectly normal.
- Do not use a memory card that is used in another digital camera. To use the memory card in this camera, format the memory card using this camera.
- Do not use a memory card formatted by another digital camera or memory card reader.
- If the memory card is subjected to any of the following, the recorded data may become corrupted:
 - When the memory card is used incorrectly.
 - If the power is switched off or the memory card is removed while recording, deleting (formatting) or reading.
- Samsung cannot be held responsible for lost data.
- It is advisable to copy important data onto other media as back-up e.g. floppy disks, hard disks, CD etc.
- If there is insufficient memory available:
A [Memory Full!] message will appear and the camera will not operate. To optimise the amount of memory in the camera, replace the memory card or delete unnecessary images stored on the memory card.



- Don't remove the memory card when the camera status lamp is blinking as this may cause damage to data in the memory card.

Instructions on how to use the memory card

The camera can use SD/ SDHC Memory Cards and MMC (Multi Media Cards).

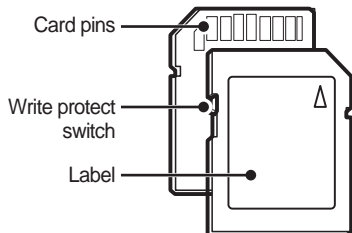

<SD (Secure Digital) memory card>

The SD/ SDHC memory card has a write protect switch that prevents image files from being deleted or formatted. By sliding the switch to the bottom of the SD memory card, the data will be protected. By sliding the switch to the top of the SD memory card, the data protection will be cancelled. Slide the switch to the top of the SD memory card before taking a picture.

When using a 1GB SD memory, the specified shooting capacity will be as follows. These figures are approximate as image capacities can be affected by variables such as subject matter and memory card type.

	Recorded image size	Super Fine	Fine	Normal	30FPS	20FPS	15FPS
Still image	13M	147	284	418	-	-	-
	12M	167	315	465	-	-	-
	10M	199	384	547	-	-	-
	8M	246	462	680	-	-	-
	5M	379	720	1015	-	-	-
	3M	601	1067	1510	-	-	-
	1M	1876	2814	2948	-	-	-
* Movie clip	800	-	-	-	-	about 35 MIN	-
	640	-	-	-	about 36 MIN	-	about 70 MIN
	320	-	-	-	about 120 MIN	-	about 120 MIN

* The recording times can be changed by the zoom operation. The zoom button doesn't function during the movie recording.

When using the camera for the first time

- Charge the rechargeable battery fully before using the camera for the first time.
- When the camera is turned on for the first time, a menu will be displayed in the LCD monitor to set date, time and language. This menu will not be displayed again after setting up the date, time and language. Set up the date, time and language before using this camera.

■ Setting up the language

1. Select the [Language] menu by pressing the **Up/Down** button and press the **Right** button.
2. Select the desired sub menu by pressing the **Up/Down** button and press the **OK** button.
 - You can select one of 26 languages. These are listed below:
English, Korean, French, German, Spanish, Italian, S.Chinese, T.Chinese, Japanese, Russian, Portuguese, Dutch, Danish, Swedish, Finnish, Thai, Bahasa (Malay / Indonesian), Arabic, Czech, Polish, Hungarian, Turkish, Estonian, Lithuanian, Latvian and Persian.



■ Setting up the date, time and date type

1. Select the [Date&Time] menu by pressing the **Up/Down** button and press the **Right** button.
2. Select the desired sub menu by pressing the **Up/Down/Left/Right** button and press the **OK** button.

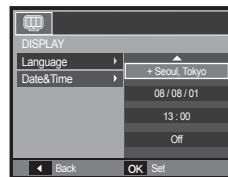

- Right** button: Selects world time/year/ month/ day/hour/minute/ date type
- Left** button: Moves the cursor to the [Date&Time] main menu if the cursor is at the first item of the date and time setup. In all other instances, the cursor will be shifted to the left of its current position.
- Up/Down** button: Changes the value of each item.

- ✕ For more information about the World Time, refer to the page 75.

LCD monitor indicator

The LCD monitor displays information about the shooting functions and selections.

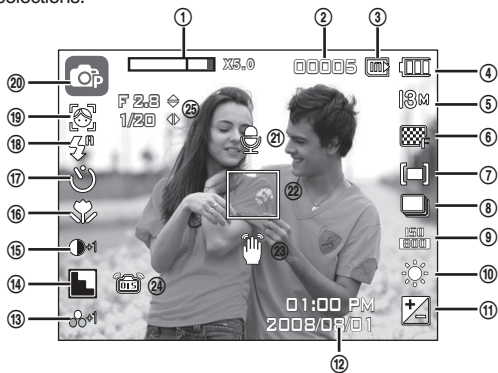

<Image & Full Status>

No.	Description	Icons	Page
1	Optical/Digital Zoom bar/ Digital Zoom rate	x 5.0	p.28~29
2	Number of available shots remaining/Remaining time	00005/00:00:00	p.17
3	Memory card icon/ Internal memory icon	/	-
4	Battery		p.15
5	Image Size	13M 10M 5M 1M 800 640 320	p.37

No.	Description	Icons	Page
6	Image Quality/Frame Rate		p.38
7	Metering/Stabiliser		p.38/p.42
8	Drive mode		p.39
9	ISO		p.39
10	White Balance		p.40
11	Exposure compensation		p.41
12	Date/Time	2008/08/01 01:00 PM	p.75
13	Saturation		p.44
14	Sharpness/Mic. off		p.44/p.25
15	Contrast		p.44
16	Macro		p.30~31
17	Self-timer		p.34~35
18	Flash		p.32~33
19	Face Detection · Self Portrait · Smile Shot · Blink Detection /Colour		p.46~47/ p.43
20	Recording mode		p.11
21	Voice Memo		p.49
22	Auto Focus Frame		p.48
23	Camera shake Warning		p.21
24	OIS (Optical Image Stabilization)		p.45
25	Aperture Value/Shutter Speed	F 2.8 1/20	p.41

Starting the Recording mode

Selecting modes

You can select the shooting modes by using the mode dial on the upper of your camera.

■ How to use the mode dial

Select the shooting mode by turning the mode dial to the selection point.

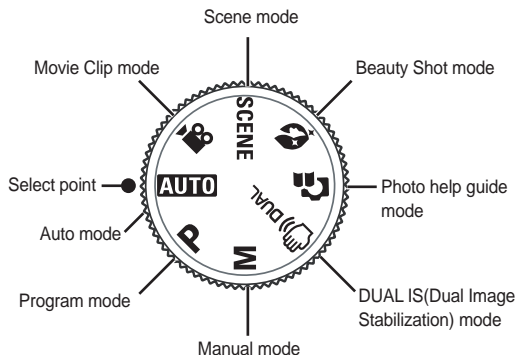

How to use the Auto mode

Select this mode for quick and easy picture taking with minimal user interaction.

1. Insert the battery (p.15) taking note of the correct polarity (+/-).
2. Insert the memory card (p.15). As this camera has a 30MB internal memory, it is not essential to insert the memory card. If the memory card is not inserted, an image will be stored in the internal memory. If the memory card is inserted, an image will be stored on the memory card.
3. Close the battery chamber cover.
4. Press the **POWER** button to turn on the camera. (If the date/time that is displayed on the LCD monitor is incorrect, reset the date/time before taking a picture.)
5. Select the Auto mode by using the mode dial.
6. Point the camera towards the subject and compose the image.
7. Press the **Shutter** button to capture an image.



- If the auto focus frame turns to red when you press the **Shutter** button down half way, it means that the camera cannot focus on the subject. Should this be the case, the camera is less likely to capture an image clearly.
- Avoid obstructing the lens or the flash when you capture an image.

Starting the Recording mode

How to use the Program mode

Selecting the automatic mode will configure the camera with optimal settings and you can manually configure various functions.

1. Select the Program mode by using the **Mode dial**. (p.20)
2. Point the camera towards the subject and compose the image by using the LCD monitor.
3. Press the **Shutter** button to capture an image.

* Refer to page 37-41 for more information about the Program mode menus.



How to use the DUAL IS(Dual Image Stabilization) mode

This mode will reduce the effect of camera shake and help you get a well exposed image in dim conditions.

1. Select the DUAL IS mode by using the **Mode dial**. (p.20)
2. Point the camera towards the subject and compose the image by using the LCD monitor.
3. Press the **Shutter** button to capture an image.



- Things to watch out for using the DUAL IS mode
 - The digital zoom will not operate in the DUAL IS mode.
 - If the lighting conditions are brighter than fluorescent lighting conditions, the DUAL IS will not activate.
 - If the lighting conditions are darker than in fluorescent lighting conditions, camera shake warning indicator (🚨) will be displayed. For best results only take pictures in situations where the camera shake warning indicator (🚨) is not displayed.
 - If the subject is moving, the captured image may be blurred.
 - For best results, avoid moving the camera while the [Capturing!] message is displayed.
 - As the DUAL IS uses the camera's digital signal processor, it may take a little longer for the camera to process and save the images.
 - If the image size is (12M) or (10M), the DUAL IS mode can't be selected.

How to use the Manual mode

The user can manually set both the aperture value and the shutter speed.

1. Select the Manual mode by using the **Mode dial**. (p.20)
2. Point the camera towards the subject and compose the image by using the LCD monitor.
3. Press the **Shutter** button to capture an image.

* Refer to page 41 for more information about the menus.



Starting the Recording mode

Using the Photo Help guide mode

Helps the user learn the correct picture taking method and includes solutions for potential problems that may occur. This also enables the user to practice the best way to take pictures.

■ Function that can be used when focusing is difficult



Available functions of the photo help guide

- Function that can be used when focusing is difficult
- Function that can be used when the image is blurred
- Function that can be used when filming in the dark
- Function that can be used when adjusting the picture brightness
- Function that can be used when adjusting the picture colour

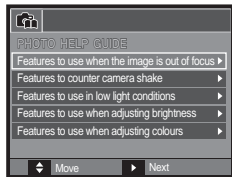

Pressing the
Left/Right button.

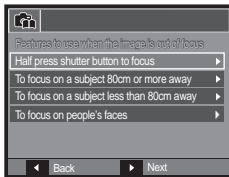

Pressing the
Left/Right button.

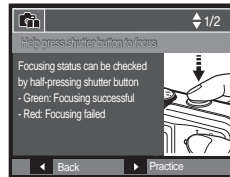

Pressing the
Up/Down button.

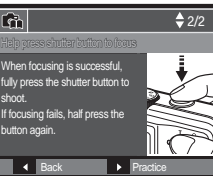

Pressing the **MENU** button.



Pressing the
Shutter button.

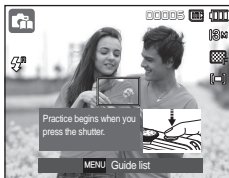

Pressing the
Right button.



Starting the Recording mode

How to use the Beauty Shot mode

Take a photo of portraits by setting options to clear facial imperfections.

1. Select the Beauty Shot mode by using the **Mode dial**. (p.20)
2. Point the camera towards the subject and compose the image by using the LCD monitor.
3. Press the **MENU** button.
4. Press the **Up/Down** button to select [Face Tone] or [Face Retouch].
5. Press the **Right** button, then press the **Up/Down** button to select a desired level of each function.
The higher the level is, [Face Tone] becomes brighter and [Face Retouch] features better performance.
6. Press the **OK** button to finish your setting.
7. Capture images in Recording mode by pressing the **Shutter** button.



How to use the Scene modes











Use the menu to easily configure optimal settings for a variety of shooting situations. (p. 51)

1. Select the Scene mode by using the **Mode dial**. (p.20)
2. Point the camera towards the subject and compose the image by using the LCD monitor.
3. Press the **Shutter** button to capture an image.



Starting the Recording mode

- The scene modes are listed below. (p.51)

Icons	Scene modes	Description
	Nightscene	Use this for shooting still images at night or in other dark conditions.
	Portrait	Selecting the portrait mode will configure the camera with optimal settings for portrait photography.
	Children	To take a picture of fast moving objects, for example, children.
	Landscape	To take pictures of distant scenery.
	Close up	Close-up shooting for small objects such as plants and insects.
	Text	Use this mode to shoot a document.
	Sunset	For taking pictures of sunsets.
	Dawn	Daybreak scenes.
	Backlight	Portrait without shadows caused by backlight.
	Firework	Firework scenes.
	Beach&Snow	For ocean, lake, beach and snowscape scenes.

How to use the Movie clip mode

A movie clip can be recorded for up to 2hours.

1. Select the Movie clip mode by using the **Mode dial**. (p.20)
2. Point the camera towards the subject and compose the image by using the LCD monitor.
3. Press the **Shutter** button once and movie clips are recorded for up to 2 hours. Movie clips will still be recorded if the **Shutter** button is released.

If you wish to stop recording, press the **Shutter** button again.

- * Image size and type are listed below.
 - Image size: 800x592, 640x480, 320x240
 - Movie clip file type: AVI (MPEG-4)
 - Frame Rate: 30FPS, 20FPS, 15FPS
 - The frame rate can be selected when the following image size is selected.
 - 800x592: 20FPS selectable
 - 640x480, 320x240: 30FPS, 15FPS selectable



Starting the Recording mode

Recording the movie clip without sound

You can record the movie clip without sound.

Steps from 1-3 are the same as those for Movie clip mode.

4. Press the **MENU** button.
5. Select the [RECORDING] menu by pressing the **Left/Right** button.
6. Press the **Down** button to select the [Voice Mute] menu and press the **Right** button.
7. Select the [On] menu by pressing the **Up/Down** button.
8. Press the **OK** button. You can record a movie without sound.

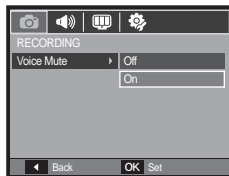

Pausing while recording a movie clip (Successive Recording)

This camera allows you to temporarily stop during unwanted scenes, while recording a movie clip. Using this function, you can record your favourite scenes into a movie clip without having to create multiple movie clips.

■ Using Successive Recording

Steps from 1-2 are the same as those for Movie clip mode.

3. Point the camera towards the subject and compose the image by using the LCD monitor. Press the **Shutter** button and movie clips are recorded for as long as the available recording time. Movie clips will still be recorded if the **Shutter** button is released.
4. Press the **Play & Pause** (▶||) button to pause recording.
5. Press the **Play & Pause** (▶||) button again to resume the recording.
6. If you wish to stop recording, press the **Shutter** button again.



Things to watch out for when taking pictures

- Pressing the **Shutter** button down half way.
Lightly press the **Shutter** button to confirm focus and flash battery charge.
Press the **Shutter** button all way down to take the picture.

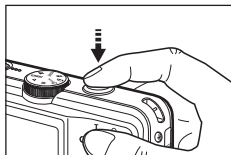

<Lightly press the **Shutter** button>

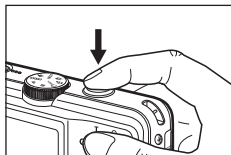

<Press the **Shutter** button down all the way>

- The available memory capacity may vary depending on shooting conditions and camera settings.
- When the Flash Off or Slow synchro mode is selected in a low lighting condition, the camera shake warning indicator (📷) may appear on the LCD monitor. In this case, use a tripod, support the camera on a solid surface or change to flash shot mode.
- It is best to take pictures with the sun in the background. Taking pictures against the sun may make the picture come out dark. To take a picture against the light, please use the [Backlight] in scene shooting mode (see page 24), fill-in flash (see page 33), spot metering (see page 38), exposure compensation (see page 41) or ACB (see page 48) function.

- Avoid obstructing the lens or the flash when you capture an image.
- Compose the image by using the LCD monitor.
- Under certain conditions the auto focus system may not perform as expected.
 - When photographing a subject that has little contrast.
 - If the subject is highly reflective or shiny.
 - If the subject is moving at high speed.
 - When there is strong reflected light, or when the background is very bright.
 - When the subject matter has only horizontal lines or the subject is very narrow (such as a stick or flagpole).
 - When the surroundings are dark.

Focus lock

To focus on a subject not positioned in the centre of the picture, use the focus lock function.

■ Using the Focus Lock

1. Ensure the subject is in the centre of the autofocus frame.
2. Press the **Shutter** button halfway. When the green auto focus frame lights up, it means the camera is focused on the subject. Be careful not to press the **Shutter** button all the way down to avoid taking an unwanted picture.
3. With the **Shutter** button still pressed down only halfway, move the camera to recompose your picture as desired, and then press the **Shutter** button completely to take the picture. If you release your finger from the **Shutter** button, the focus lock function will be cancelled.



1. The image to be captured.



2. Press the **Shutter** button halfway and focus on the subject.



3. Recompose the picture and fully depress the **Shutter** button.

Using the camera buttons to set the camera

The recording mode function can be set up by using the camera buttons.

POWER button

Used for turning the camera's power on/off. If there is no operation during the specified time, the camera's power will be turned off automatically to save battery life.

Refer to page 79 for more information about the auto power off function.

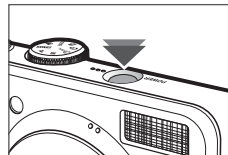

Shutter button

Used for taking an image or recording voice in the Recording mode.

- In Movie clip mode
Pressing the **Shutter** button fully starts the process for recording a movie clip. Press the **Shutter** button once and the movie clip is recorded for as long as the available recording time in the memory allows. If you wish to stop recording, press the **Shutter** button again.
- In Still image mode
Pressing the **Shutter** button down halfway activates the autofocus and checks the condition of the flash.
Pressing the **Shutter** button down fully takes and stores the image. If you select voice memo recording, the recording will start after the camera has finished storing the image data.

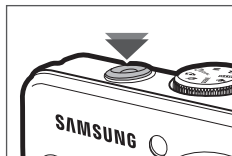

ZOOM W / T button

If the menu is not displayed, this button works as the **OPTICAL ZOOM** or **DIGITAL ZOOM** button. This camera has a 3.6X optical zoom and a 5X digital zoom function. Using both will offer a total zoom ratio of 18X.

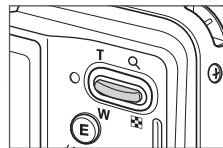

■ TELE Zoom

Optical zoom TELE: Pressing the **Zoom T** button. This will zoom into the subject i.e. the subject will appear nearer.

Digital zoom TELE: When the maximum (3.6X) optical zoom is selected, pressing the **Zoom T** button activates the digital zoom software. Releasing **Zoom T** button stops the digital zooming at the required setting. Once the maximum digital zoom (5X) is achieved, pressing the **Zoom T** button will have no effect.

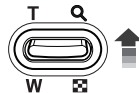

ZOOM W / T button

■ WIDE Zoom

Optical zoom WIDE: Pressing the **Zoom W** button. This will zoom out from the subject i.e. the subject will appear further away. Pressing the **Zoom W** button continuously will set the camera to its minimum zoom setting i.e. the subject appears at its furthest from the camera.

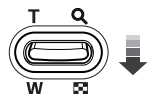

Digital zoom WIDE: When the digital zoom is in operation, pressing the **Zoom W** button will reduce the digital zooming in steps. Releasing **Zoom W** button stops digital zooming. Pressing the **Zoom W** button will reduce the digital zoom and then it will continue to reduce the optical zoom until the minimum setting is reached.

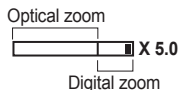

- Images taken using the digital zoom may take a little longer for the camera to process. Allow time for this to take place.
- The digital zoom cannot be used in movie clip shots.
- You may notice a decrease in image quality when using the digital zoom.
- To view a clearer digital zoom image, press the **Shutter** button halfway at the maximum optical zoom position and press the **Zoom T** button again.
- The digital zoom can't be activated in the [Face Detection] mode, [DUAL IS] mode, [Movie] mode, [Beauty Shot] mode and some scene modes ([Nightscape], [Portrait], [Children], [Text], [Close-up], [Firework]).
- Take care not to press the lens as this may cause a camera malfunction.
- If you use the zoom during video capture, audio is not recorded.

Function Description / Info (I) / Up button

While the menu is showing, the Up button operates as a direction button. If the menu screen does not appear, information or function descriptions of the current filming image (filming mode) can be accessed through the liquid crystal monitor by pressing the Function description / Information (I) button.



<Filming screen>

<Information screen>

<Function description screen>

- Function description: When pressing the Function description button on the information screen mode, detailed descriptions of the functions can be viewed. The function description can be cancelled by pressing the Function description button again.



<Examples of Function descriptions>

Macro (🌸) / Down button

While the menu is showing, press the **Down** button to move from the main menu to a sub menu, or to move down the sub menu. When the menu is not showing, you can use the **Macro/Down** button to take macro pictures. The distance ranges are shown below. Press the **Macro** button until the desired macro mode indicator appears on the LCD monitor.



<Auto Focus>



<Macro (🌸)>



<Auto Macro (🌸)>

Macro (🌸) / Down button

■ Types of focus mode and focus range (W: Wide, T: Tele) (Unit: cm)

Mode	Auto (📷)	
Focus Type	Auto macro (🌸)	Normal
Focus range	W: 5 ~ Infinity T: 50 ~ Infinity	W: 80 ~ Infinity T: 80 ~ Infinity
Mode	Program (📷)	
Focus Type	Macro (🌸)	Normal
Focus range	W: 5 ~ 80 T: 50 ~ 80	W: 80 ~ Infinity T: 80 ~ Infinity
Mode	DUAL IS mode (📷)	
Focus Type	Auto macro (🌸)	Normal
Focus range	W: 5 ~ Infinity T: 50 ~ Infinity	W: 80 ~ Infinity T: 80 ~ Infinity



- When the macro mode is selected, be particularly careful to avoid camera shake.
- When you take a picture within 50cm (Wide zoom) or 50cm (Tele zoom) in the Macro mode, select the FLASH OFF mode.
- When you take a picture within the 5cm Super macro range, the autofocus on the camera will take longer to set the correct focus distance.

■ Available focusing method, by Recording mode

(●: Selectable, ∞: Infinity focus range)

Mode	Auto macro	Macro	Normal
📷	●		●
📷		●	●
M		●	●
📷	●		●
📷		●	●
📷			●
📷		●	●
Mode	SCENE		
	Auto macro	Macro	Normal
📷			●
📷			●
📷			●
📷			●
T	●		
🌸		●	
📷			●
📷			●
📷			●
📷			∞
📷			●

Flash (⚡) / Left button

When the menu is displayed on the LCD monitor, pressing the **Left** button makes the cursor shift to the left tab.

When the menu is not displayed on the LCD monitor, the **Left** button operates as the **Flash**(⚡) button.

■ Selecting the flash mode

1. Select a desired Recording mode, except the [Movie] mode and the [DUAL IS] mode. (p.20)
2. Press the **Flash** button until the desired flash mode indicator is displayed on the LCD monitor.
3. A flash mode indicator will be displayed on the LCD monitor. Use the correct flash to suit the environment.

■ Flash range

(Unit: m)

ISO	Normal		Macro		Auto macro	
	WIDE	TELE	WIDE	TELE	WIDE	TELE
AUTO	0.8~4.6	0.8~2.3	0.5~0.8	0.5~0.8	0.5~4.6	0.5~2.3



- If you press the **Shutter** button after selecting the flash, the first flash fires to check the shooting condition (Flash range and Power ratio of flash). Do not move the camera until the second flash fires.
- Using the flash frequently will reduce the life of the battery.
- Under normal operating conditions the re-charging time for the flash is usually within 4 seconds. If the battery is weak, the charging time will be longer.
- In the [DUAL IS] mode, [Landscape], [Close up], [Text], [Sunset], [Dawn], [Firework] scene modes and the Movie clip mode, the flash function will not operate.
- Take photographs within the flash range.
- The image quality is not guaranteed if the subject is too close or highly reflective.
- When taking an image in poorly lit conditions with the flash, there may be a white speck in the captured image. The speck is caused by the the flash light reflecting off atmospheric dust.

Self-timer (⌚) / Right button

When the menu is displayed on the LCD monitor, pressing the **Self-timer** (⌚) / **Right** button makes the cursor shift to the right tab. When the menu is not displayed on the LCD monitor, the **Self-timer** (⌚) / **Right** button operates as the **Self-timer** (⌚) button. This function is used when the photographer would also like to be in the image.



- If you operate the **Self-timer**(⌚) button during the self-timer operation, the self-timer function is cancelled.
- Use a tripod to prevent the camera from shaking.
- In Movie Clip mode, only the 10SEC self-timer will work.
- When you select 2SEC self-timer with flash, the delay (2 seconds) can be extended according to the flash charging status.

■ Selecting the self-timer

1. Select a Recording mode with the exception of Voice recording mode. (p.20)
2. Press the **Self-timer** (⌚) button until the desired mode indicator displays on the LCD monitor.
3. When you press the **Shutter** button, the picture will be taken after the specified time has elapsed.



<Selecting the 10 SEC self-timer>

Icon	Self-timer Mode	Description
	10SEC self-timer	Pressing the Shutter button will allow an interval of 10 seconds before the image is taken.
	2SEC self-timer	Pressing the Shutter button will allow an interval of 2 seconds before the image is taken.
	Double self-timer	A picture will be taken after about 10 seconds and 2 seconds later a second picture will be taken.
	Motion Timer	The camera detects the subject's movement 6 seconds after pressing the Shutter button, and the picture is taken when the movement is stopped.

Self-timer (☺) / Right button

■ Motion Timer

Motion	Icon & Self-timer lamp
Pressing the Shutter button after setting the Motion Timer	Blink (1 second interval)
Detecting the subject's movement	Blink (0.25 second interval)
No movement is detected	Turn on and the image is taken after 2 seconds.

■ The Motion Timer flows are as follows. (Movie Clip mode excluded)

Selecting the Motion Timer → Pressing the Shutter button → Confirming the composition (Within 6 sec.)¹ → Starting the detection (Swing your hands fully)² → Stopping the detection (Do not move) → Taking an image (after 2 sec.)

*1: The camera detects the subject's movement 6 seconds after pressing the Shutter button, so confirm the composition within 6 seconds.

*2: Move your body or hands fully.



In the following cases, the Motion Timer may not operate.

- The focus distance is over 3m.
- The exposure is too bright or dark
- In backlight conditions.
- The movement is insignificant
- The movement is detected beyond the center part (50%) of the sensor where the movement is recognized.
- If the camera doesn't sense detect any movement for 25 seconds, or the camera doesn't detect stillness after sensing movement.



<The detection range of Motion Timer>

MENU / OK button

■ MENU button

- When you press the **MENU** button, a menu related to each camera mode will be displayed on the LCD monitor. Pressing it again will return the LCD to the initial display.
- A menu option can be displayed when the following are selected: [Movie], [Auto], [Program], [Manual], [DUAL IS], [Beauty Shot] and [Scene] mode.
There is no menu available when the Voice recording or [Photo Help Guide] mode is selected.

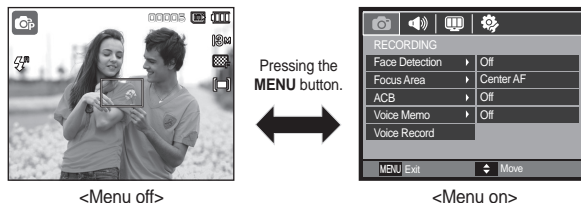

■ OK button

- When the menu is displayed on the LCD monitor, this button is used for shifting the cursor to the sub menu or for confirming data.

Fn button

You can use the **Fn** button to set the following menus.

(●: Selectable)

			M			SCENE		Page
SIZE	●	●	●	●	●	●	●	p.37
QUALITY/ FRAME RATE	●	●	●	●	●	●	●	p.38
METERING		●	●	●			●	p.38
DRIVE		●	●			●*		p.39
ISO		●	●					p.39
WHITE BALANCE		●	●	●			●	p.40
EV (Exposure Value)		●		●			●	p.41
Aperture Value/ Shutter Speed			●					p.41
STABILISER							●	p.42

* In [Children] scene mode, [DRIVE] is available.

Fn button

How to use the Fn menu

1. Press the **Fn** button in an available mode
2. Select a desired menu by pressing the **Up/Down** button. And then a sub menu will be displayed on the bottom left side of the LCD monitor.

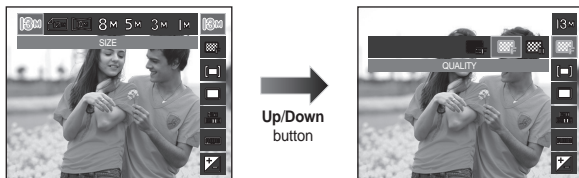

3. Select a desired menu by pressing the **Left/Right** button and then press the **OK** button.

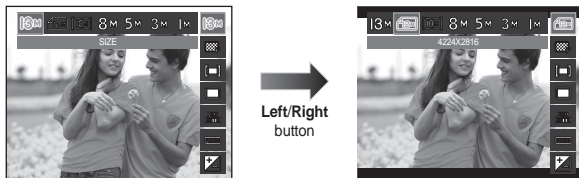

Fn button: Size

You can select the image size appropriate for your application.

Still image Mode	Icon	13M	12M	10M	8M	5M	3M	1M
	Size	4224x3168	4224x2816	4224x2376	3264x2448	2592x1944	2048x1536	1024x768
Still image Mode	Icon	800		640		320		
	Size	800x592		640x480		320x240		



< Still image mode >

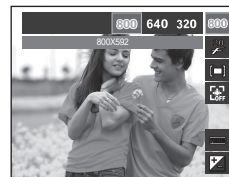







< Movie clip mode >



The higher the resolution, the lower the number of shots available because high resolution images require more memory.

Fn button: Quality / Frame rate

You can select the compression ratio appropriate for your application of the captured images. The higher the compression ratio, the lower the picture quality.

Mode	Still image Mode			Movie clip mode		
Icon						
Sub menu	Super Fine	Fine	Normal	30 FPS	20 FPS	15 FPS
File Format	jpeg	jpeg	jpeg	avi	avi	avi



< Still image mode >



< Movie clip mode >





- This file format complies with the DCF (Design rule for Camera File system).
- JPEG (Joint Photographic Experts Group): JPEG is the image compression standard developed by the Joint Photographic Experts Group. This type of compression is most commonly used for compressing photos and graphics because it can compress the files efficiently.

Fn button: Metering

If you cannot obtain suitable exposure conditions, you can change the metering method to take brighter pictures.



Icon	Metering Mode	Description
	Multi	Exposure will be calculated based on an average of light in each image area divided into multiple regions. However, the calculation will be biased towards the centre of the image area. This is suitable for general use.
	Spot	Only the rectangular area in the centre of the LCD monitor will be metered for light. This is suitable when the subject in the centre is exposed correctly, regardless of the back lighting.
	Center Weighted	Exposure will be calculated based on an average of the available light in the image area. However, the calculation will be biased towards the centre of the image area. This is suitable for taking a picture of small objects like flowers or insects.

- * If the subject is not the centre of the focus area, do not use the [Spot] metering as this may result in an exposure error. In this circumstance, it is better to use exposure compensation.

Fn button: Drive mode

You can select continuous shot, and AEB (Auto Exposure Bracketing).



Icon	Drive Mode	Description
	Single	Take one picture only.
	Continuous	Images will be taken continuously until the Shutter button is released.
	AEB	Take three pictures in a series in different exposures: standard exposure (0.0EV), short exposure (-1/3EV) and over exposure (+1/3EV).
	Motion Capture	This takes 6 shots per second for up to 5 seconds, when the Shutter is pressed and held down. After completing the continuous shooting, images are saved automatically. The maximum number of shots is 30 and the image size is fixed as VGA.



- High resolution and picture quality increases file saving time, which increases stand-by time.
- If the [Continuous], [Motion Capture] or [AEB] sub menu is selected, the flash will be off automatically.
- If less than 30 pictures are available in the memory, the motion capture is not available.
- It is best to use a tripod for the AEB shooting as the time to save each image file is longer and blurring caused by camera shake may occur.
- In [Manual] mode, [AEB] does not operate.
- When [Smile Shot] or [Blink Detection] is set, [Continuous], [Motion Capture] and [AEB] functions are not available.

Fn button: ISO

You can select the ISO sensitivity when taking pictures.
The speed or specific light-sensitivity of a camera is rated by ISO numbers.



Icon	ISO Mode	Description
	Auto	The camera's sensitivity is automatically changed by variables such as lighting value or subject brightness.
	ISO 80	You use a faster (shorter) shutter speed while the same amount of light is present, by increasing the ISO sensitivity amount of light is present, by increasing the ISO sensitivity. However, the image may be saturated in high luminance. The higher the ISO value, the higher the camera's sensitivity to light and therefore the greater its capacity to take pictures in dark conditions. However, the noise level in the image will increase as the ISO value increases, making the image appear coarse.
	ISO 100	
	ISO 200	
	ISO 400	
	ISO 800	
	ISO 1600	
	ISO 3200	

- ✘ When the ISO 3200 menu is selected, the image size is fixed to under 3M.
- ✘ When [Motion Capture] is set, ISO speed will be set to Auto.

Fn button: White balance

The white balance control allows you to adjust the colours to appear more natural.



Icon	White balance Mode	Description
	Auto WB	The camera automatically selects the appropriate white balance settings, depending on the prevailing lighting conditions.
	Daylight	For taking images outside.
	Cloudy	For taking images under a cloudy or overcast sky.
	Fluorescent_H	For shooting under daylight fluorescent types of threeway fluorescent lighting.
	Fluorescent_L	For shooting under white fluorescent lighting.
	Tungsten	For shooting under tungsten (standard light bulb) lighting.
	Measure : SH	Allows the user to set the white balance according to the shooting conditions.

× Different lighting conditions may cause a colour cast on your images.

■ Using the Custom White Balance

White balance settings may vary slightly depending on the shooting environment. You can select the most appropriate white balance setting for a given shooting environment by setting up the custom white balance.

1. Select the Measure : SH () menu of the White Balance and place a sheet of white paper in front of the camera so that the LCD monitor shows only white.
2. **MENU/OK** button: Selects previous custom white balance.

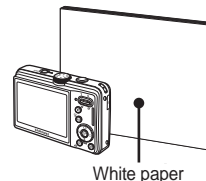

Shutter button: Saves new custom white balance.

- The custom white balance value will be applied, starting with the next picture you take.
- The user configured white balance will be remain effective until it is overwritten.



Fn button: Exposure compensation

This camera automatically adjusts the exposure according to the ambient lighting conditions.

You can also select the exposure value by using the **Fn** button.



■ Compensating Exposure

1. Press the **Fn** button, and then use the **Up/Down** button to select the exposure compensation () icon. The exposure compensation menu bar will appear as shown.
 2. Use the **Left/Right** button to set the desired exposure compensation factor.
 3. Press the **OK** button or **Fn** button again. The value you set will be saved and the Exposure Compensation setup mode will close. If you change the exposure value, the exposure indicator () will be displayed on the bottom of the LCD monitor.
- ※ A negative exposure compensation value reduces the exposure. Note that a positive exposure compensation value increases the exposure and the LCD monitor should appear white or you may not get good pictures.

Fn button: Aperture Value

This mode will set the aperture value for automatic exposure in manual mode. Smaller aperture values make the object sharp but blur the background. Larger aperture values make both the object and background sharp.

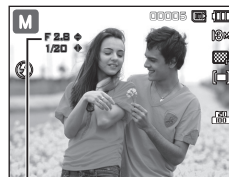

Aperture Value

■ Setting up the Aperture Value

Press the **Fn** button, then press **Up/Down** button to set the desired Aperture Value.

Fn button: Shutter Speed

This mode will set the shutter speed for automatic exposure in manual mode. High shutter speeds can capture a moving object in a way that makes it seem as if the object is not moving. Low shutter speeds can capture a moving object, giving it a dynamic feeling of movement.



Shutter Speed

■ Setting up the Shutter Speed

Press the **Fn** button, then press the **Left/Right** button to set the desired Shutter Speed.

Fn button: Movie clip frame stabiliser

This function helps stabilize images captured during movie recording. You can select this menu only in the Movie clip mode. If the memory card is not inserted, this function will not operate.

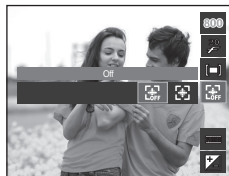

[Off]: Movie clip frame stabilizer function is disabled.

[On]: Minimises camera shake during movie recording.

× The recording frame range becomes narrow when you select this menu.

E (Effect) button

It is possible to add special effects to your images by using this button.

■ Available Effects, by recording mode (●: Selectable)

Mode	E button	Mode	E button
	●		●
	●		●
	●		
			●
	●		
	●		
	●		



- This button will not operate in [DUAL IS], [Beauty Shot] mode, Voice recording mode and some scene modes ([Nightscape], [Text], [Sunset], [Dawn], [Backlight], [Firework], [Beach&Snow]).
- Even if the camera is turned off, the effect setting will be preserved.

E (Effect) button: Image editing

Press the E button in the [Auto], [Program], [Manual], [Movie] and some scene modes ([Portrait], [Children], [Landscape], [Close up]).

Colour

1. Select the desired sub menu by pressing the **Left/Right** button and press the **OK** button.
2. Press the **Shutter** button to take an image.



Icon	Color	Description
NOR	Normal	No colour effect is added to the image.
BW	B/W	Captured images will be stored in black and white.
S	Sepia	Captured images will be stored in a sepia tone (a gradient of yellowish brown colours).
R	Red	Captured images will be stored in a red tone.
G	Green	Captured images will be stored in a green tone.
B	Blue	Captured images will be stored in a blue tone.
I	Negative	Saves the image in negative mode.
C	Custom Color	Captured image will be saved in set RGB tone.

- Custom colour: You can change the R (Red), G (Green) and B (Blue) values of the image.



- **OK** button: Selects / sets up the Custom Colour
- **Up/Down** button: Selects R, G, B
- **Left/Right** button: Changes the values



E (Effect) button: Image editing

Press the E button in the [Program], [Manual] mode.

Sharpness

1. Select the Sharpness() menu by pressing the **Up/Down** button and a bar for selecting the sharpness will be displayed.
2. Change the sharpness by pressing the **Left/Right** button and press the **OK** button.
3. Press the **Shutter** button to take an image.

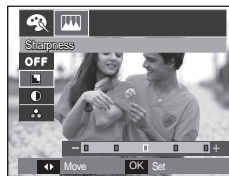

Saturation

1. Select the Saturation() menu by pressing the **Up/Down** button and a bar for selecting the saturation will be displayed.
2. Change the saturation by pressing the **Left/Right** button and press the **OK** button.
3. Press the **Shutter** button to take an image.



Contrast

1. Select the Contrast() menu by pressing the **Up/Down** button and a bar for selecting the contrast will be displayed.
2. Change the contrast by pressing the **Left/Right** button and press the **OK** button.
3. Press the **Shutter** button to take an image.

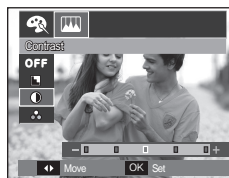

OIS button: Optical image Stabilization

The OIS function reduces blurring caused by camera shake when pressing the Shutter button.

1. Press the **OIS** button in the selectable mode.



2. The OIS icon (📷) will be displayed on the left side.
3. Press the **Shutter** button halfway. The shutter speed and aperture value will be displayed on the LCD monitor. Also this camera activates the stabilizing function.
4. Press the **Shutter** button fully to take a picture.



- OIS function may not work sufficiently in the following cases.
 - To take pictures of a moving subject
 - To take pictures with higher digital zoom values
 - When camera shake is beyond the camera-shake correction range
 - When the shutter speed is slow
- If you activate the OIS function during video capture, the operation sound of the button or sensor may be recorded along.

Using the LCD monitor to adjust the camera settings

You can use the menu on the LCD monitor to set up recording functions.

- The items indicated by are default settings.

Menu	Sub menu		Available mode	Page
Face Detection	Off	Face Detection*		p.46-47
	Self Portrait	Smile Shot		
	Blink Detection			
Focus Area	Center AF	Multi AF		p.48
ACB	Off	On		p.48
Voice Memo	Off	On		p.49
Voice Record	-			p.49
Voice Mute	Off	On		p.50
Scene	Nightscene	Portrait		p.51
	Children	Landscape		
	Close up	Text		
	Sunset	Dawn		
	Backlight	Firework		
	Beach&Snow			

* Menus are subject to change without prior notice.

* In [Beauty Shot], [Portrait], and [Children] mode, the [Face Detection] function setting is set to its default value.

Face Detection

If you use face detection options, your camera can detect a human face. When focusing on a human face, the brightness of the face is also adjusted. You can also capture natural facial expressions by using self portrait, smile shot or blink detection.



※ Selectable modes: [Auto], [Program], [Manual], [DUAL IS], [Beauty Shot], [Scene] ([Portrait], [Children], [Beach&Snow])

■ Face Detection

This mode detects the face position of the subject automatically and then sets the focus and exposure.

1. The size and position of the auto focus frame is automatically set on the face of the subject.



2. Press the **Shutter** button halfway.

- When the camera detects a target face, the white colour focus frame will be displayed over the target face and the grey colour focus frame appears over the remaining faces. Press the shutter button halfway down to focus on the face and the white focus frame turns green.

3. Press the **Shutter** button fully to take a picture.



- This function can detect up to 10 faces.
- When the camera recognises many people at the same time, it will focus on the nearest person.
- Return to previous AF mode if face detection failed.
- In some conditions this function cannot work properly.
 - When a person wears dark glasses or some part of the face is hidden.
 - When the subject does not look at the camera.
 - Camera doesn't detect a face as the conditions are too dark or too bright.
 - The distance between the camera and object is too great.
 - If there is reflection of the light or the back light that are too bright.
- The maximum available Face Detection range is 3m (Wide).
- The nearer the subject, the faster the camera can recognize the subject.
- When using the digital zoom, [Face Detection] is not available.

Face Detection

■ Self Portrait

When taking pictures of yourself, the area of your face is automatically detected so that you can take self portraits more easily and quickly.

1. For self-filming, set the camera lens towards the face of the object.

It automatically detects the face of the object, and emits a guiding sound.

- When locating the face in the center of the screen, it repeatedly emits a faster sound unlike the sounds that are emitted when the face is not in the center.



2. Start filming by pressing the **Shutter** button.



- The guiding sound can be set using the [Self Portrait] Menu. (p.73)

■ Smile Shot

The camera automatically takes a picture by detecting the face of the subject although you don't press the shutter button. If you press the **Shutter** button, the picture is taken in the normal way. When taking a picture of smile shot, showing teeth or keeping the smiley face of your subject helps detecting the smile face of the subject.



■ Blink Detection

If the eyes of the subject are closed when the shutter button is pressed, the camera takes 2 continuous shots and then the images are saved.

The camera takes only one picture if the eyes of the subject are open when the **Shutter** button is pressed.



- Detecting the smiling face or the blinking eyes may not be available if any of the following situations occurs:
 - If the subject is wearing sunglasses.
 - When the subject is not facing directly to the camera.
 - If the environmental light is too bright or too dark to detect the face of the subject.
 - When the camera is far from the subject. (Orange colored focusing mark)
 - If there is reflection of the light or the back light that are too bright.

Focus Area

You can select your preferred Focus Area according to the shooting conditions.



Focus Area	Description
Center AF	The rectangular area in the center of the LCD monitor will be focused.
Multi AF	This camera selects all available AF points of the LCD monitor.

- × When the camera focuses on the subject, the auto focus frame turns to green. When the camera doesn't focus on the subject, the auto focus frame turns to red.

ACB

This function is to adjust the contrast automatically when taking photos in an environment with big exposure difference i.e. backlight or contrast. This function adjusts the brightness automatically and allows the subject to be photographed clearly.

- [ACB] Sub menus: [Off], [On]



- × When using the [Auto], [Program] mode and [Manual] mode, the ACB function will operate.
- × ACB function always operates in the [Auto] mode.
- × When ACB function is set, [Continuous], [Motion Capture] and [AEB] functions are not available.



Voice Memo

You can add your voice-over to a stored still image. (Max. 10 sec.)

- If the voice memo indicator is displayed on the LCD monitor, the setting is completed.
- Press the **Shutter** button and take a picture. The picture is stored on the memory card.
- Voice memo will be recorded for ten seconds from the moment the picture is stored. In the middle of the sound recording, pressing the **Shutter** button will stop the voice memo.



Voice recording

A voice can be recorded for as long as the available recording time (Max. 10 hour) allows.

Press the **Shutter** button to record a voice.

- Press the **Shutter** button once and voice is recorded for as long as the available recording time (max:10 hour) allows. The recording time will be displayed on the LCD monitor. Voice will still be recorded if the **Shutter** button is released.
- If you wish to stop recording, press the **Shutter** button again.
- File type: *.wav

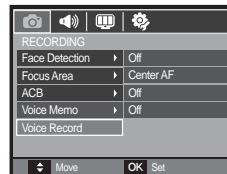

<Voice recording mode>

Voice recording

■ Pausing while recording a voice

Using this function, you can record your favourite voice clips into a voice recording file without having to create multiple voice recording files.

1. Press the **Play & Pause** (▶||) button to pause recording.
2. Press the **Play & Pause** (▶||) button again to resume the recording.
3. If you wish to stop recording, press the **Shutter** button again.



<Pausing the voice recording>



- A distance of 40cm between you and the camera (microphone) is the best distance to record sound.
- If the camera power is turned off while the voice recording is paused, the voice recording is cancelled.

Recording the movie clip without voice

You can record the movie without voice.

Select [Voice Mute] menu in the Movie clip mode. (p. 25)
(🔇) icon will appear on the LCD monitor.
Press the **Shutter** button and a movie will record for as long as the memory capacity allows without voice.



Scene mode

Use the menu to easily configure optimal settings for a variety of shooting situations.

Press the **MENU** button and select a desired sub menu.

※ Refer to page 24 for more information.



Starting play mode

Turn the camera on and select Play mode by pressing the **Play mode** (▶) button. The camera can now play back the images stored in the memory.

If the memory card is inserted in the camera, all the camera functions apply only to the memory card. If the memory card is not inserted in the camera, all the camera functions apply only to the internal memory.

Playing back a still image

1. Select the Play mode by pressing the **Play mode** button.

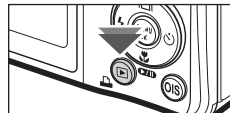

2. The last image stored on the memory is displayed on the LCD monitor.



3. Select an image that you want to view by pressing the **Left/Right** button.
 - ※ Press and hold the Left or Right button to play back the images quickly.

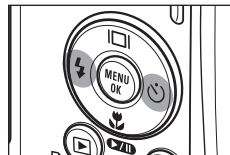

Starting play mode

Playing back a movie clip

1. Select the recorded movie clip that you want to play back by using the **Left/Right** button.
2. Press the **Play & Pause** (**▶/⏸**) button to playback a movie clip file.
 - To pause a movie clip file while playing it back, press the **Play & Pause** (**▶/⏸**) button again.
 - Pressing the **Play & Pause** (**▶/⏸**) button again will cause the movie clip file to restart.
 - To rewind the movie clip while it is playing, press the **Left** button. To fast forward the movie clip, press the **Right** button.
 - To stop playback of the movie clip, press the **Play & Pause** (**▶/⏸**) button, and then press the **Left** or **Right** button.

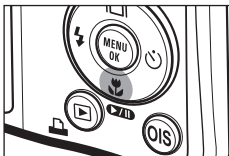

Movie clip capture function

You can capture still images from the movie clip.

■ How to capture the movie clip

1. Press the **Play & Pause** (**▶/⏸**) button while playing the movie clip. Then press the **E** button.
2. The paused movie clip is saved in a new file name.
 - × The captured movie clip file is the same size as the original movie clip (800x592, 640x480, 320x240).
 - × When you press the **E** button at the beginning of the movie clip, the first frame of the movie clip will be saved as a still image.



<Paused>

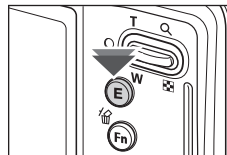

<Press the E button>

Starting play mode

On camera movie trimming

You can extract desired frames of movie clip during the movie clip play back. If the running time is under 10 seconds, the movie clip can't be trimmed.

1. Press the **Play & Pause** (▶/⏸) button at the point of the movie clip where you want to start extracting.
2. Press the **T** button.
3. Press the **Play & Pause** (▶/⏸) button and the extracted range will be displayed on the status bar.
4. Press the **Play & Pause** (▶/⏸) button once more at the point where you wish the extracted file to stop.
5. Press the **T** button and a confirmation window will be displayed.
6. Select a desired sub menu by pressing the **Up/Down** button and press the **OK** button.

[No]: The movie trimming will be cancelled.

[Yes]: The extracted frames are saved as a new file name.

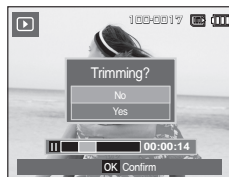
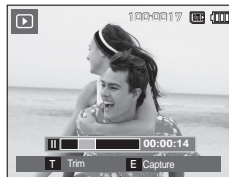

- If you don't specify the ending point of the movie clip, the trimming confirmation window will be displayed at the point of the last frame.





Playing back a recorded voice

1. Select the recorded voice that you want to play back by using the **Left/Right** button.
2. Press the **Play & Pause** (▶/⏸) button to play back a recorded voice file.
 - To pause a recorded voice file, while playing it back, press the **Play & Pause** (▶/⏸) button again.
 - To resume playback of the voice file, press the **Play & Pause** (▶/⏸) button
 - To rewind the voice file while it is playing, press the **Left** button. To fast forward the voice file, press the **Right** button.
 - To stop playback of the voice memo, press the **Play & Pause** (▶/⏸) button and then press the **OK** button.



Starting play mode

Playing back a voice memo







1. Select a still image that has the voice memo.
2. Press the **Play & Pause** () button to play back the voice memo.
 - To pause the voice memo, while playing it back, press the **Play & Pause** () button again.
 - To resume playback of the voice memo, press the **Play & Pause** () button.
 - To stop playback of the voice memo, press the **Play & Pause** () button and then press the **OK** button.

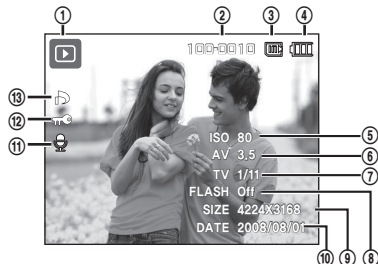

LCD monitor Indicator

The LCD monitor displays shooting information about the displayed image.



No.	Description	Icon	Page
1	Playback mode		p.51
2	Folder name & File name	100-0010	p.78
3	Internal memory icon/ Memory card icon indicator	 / 	-
4	Battery		p.15
5	ISO	80 ~ 3200	p.39
6	Aperture value	F2.8 ~ 14.4	-
7	Shutter speed	8 ~ 1/1500	-
8	Flash	On/Off	p.32~33
9	Image size	4224X3168 ~ 320X240	p.37
10	Recording date	2008/08/01	p.75
11	Voice Memo		p.67
12	Protect		p.67
13	DPOF		p.68~70

Using the camera buttons to set the camera

In Play mode, you can use the buttons on the camera to conveniently set up the Play mode functions.

Play mode button

- If you have turned on the camera by pressing the **POWER** button, you can press the **Play mode** button once to switch to Play mode and press it again to switch to Recording mode.
- You can turn the power on with the **Play mode** button. The camera is turned on in play mode. Press the **Play mode** button again to turn off the camera.
- Manner mode: To select the Manner mode, press the **Play mode** button for more than 3 seconds. In the Manner mode, Operating sound, Effect sound, Start-up sound and Shutter sound will not be generated. To cancel the Manner mode, turn on the camera by pressing the **POWER** button.

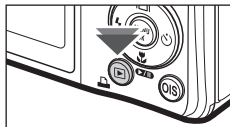

Thumbnail() / Enlargement() button

You can view multiple pictures, enlarge a selected picture, and crop and save a selected area of an image.

■ Thumbnail display

1. While an image is displayed on full screen, press the **Thumbnail** button.
2. The thumbnail display will highlight the image that had been showing at the time the thumbnail mode was selected.
3. Press the 5 function button to move to a desired image.
4. To view an image separately, press the **Enlargement** button.

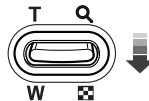

<Normal display mode>

Pressing the **Thumbnail** () button



Pressing the **Enlargement** () button

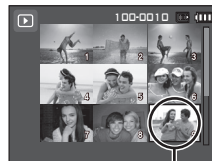

Highlighted image

<Thumbnail display mode>

Using the camera buttons to set the camera

■ Image enlargement

1. Select an image that you want to enlarge and press the **Enlargement** button.

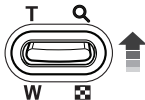

2. Different parts of the image can be viewed by pressing the 5 function button.

3. Pressing the **Thumbnail** button will zoom back to the original full sized image.

- You can tell whether the image displayed is an enlarged view by checking the image enlargement indicator shown at the top left of the LCD monitor. (If the image is not an enlarged view, the indicator will not be displayed.) You can also check the area of enlargement.
- Movie clips and WAV files can't be enlarged.
- If an image is enlarged, a loss of quality may occur.

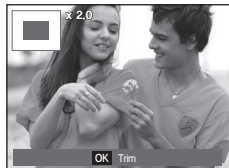

■ The maximum enlargement rate in proportion to the image size

Image size	13M	12M	10M	8M	5M	3M	1M
Maximum enlargement rate	13.2	11.7	11.0	10.2	8.1	6.4	3.2

- **Trimming:** You can extract part of the image that you want and save it separately.

1. Select an image that you want to enlarge and press the enlargement button. Press the **MENU** button and a message will be displayed.
2. Select a desired sub menu by pressing the **Up/Down** button and press the **OK** button.

- [No]: The trimming menu will disappear.
 - [Yes]: The trimmed image will be saved as a new file name, and appear on the LCD monitor.
- × If there is not enough memory space to save the trimmed image, the image can't be trimmed.



Info () / Up button

When the menu is displayed on the LCD monitor, the **Up** button operates as a direction button. When the menu is not displayed on the LCD monitor, pressing the **Info**() button will display image information on the LCD monitor.

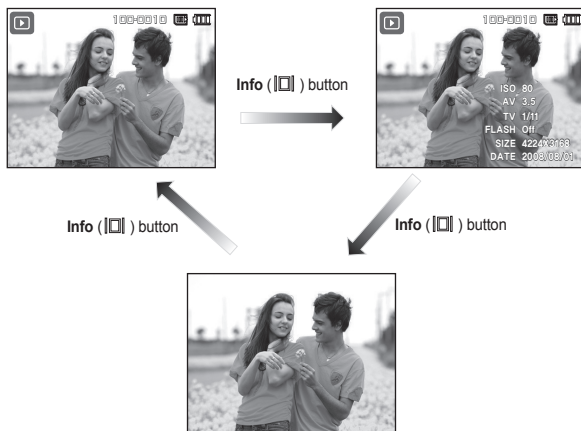

Play & Pause () / Down button

In Play mode, the **Play & Pause** () / **Down** button works as follows:

- If the menu is displayed
Press the **Down** button to move from the main menu to a sub menu, or to move down the sub menu cursor.
- If a still image with a voice memo, a voice file, or a movie clip is playing
 - In Stop mode: Plays a still image with a voice memo, a voice file, or a movie clip.
 - During playback: Temporarily stops playback.
 - In Pause mode: Resumes playback



Left / Right / Menu / OK button

Left/Right/MENU/OK button activate the following.

- **Left** button: While the menu is showing, the **Left** button operates as a direction button. While the menu is not showing, press the **Left** button to select the previous image.
- **Right** button: While the menu is showing, the **Right** button operates as a direction button. While the menu is not showing, press the **Right** button to select the next image.
- **MENU** button: When you press the **MENU** button, the play mode menu will be displayed on the LCD monitor. Pressing it again will return the LCD to the initial display.
- **OK** button: When the menu is displayed on the LCD monitor, the **OK** button is used for confirming data that is changed by using the 5 function button.

Print (🖨️) button

When the camera is connected to a PictBridge printer, you can print images by pressing the **Print** button.

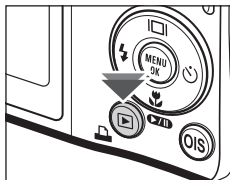

Delete (🗑️) button

This deletes images stored on the memory card. By activating the Recycle Bin function (p.78) you can restore deleted photos.

1. Select an image that you want to delete by pressing the **Left/Right** button and press the **Delete** button.

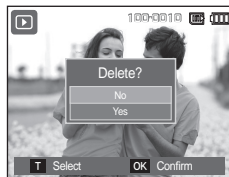
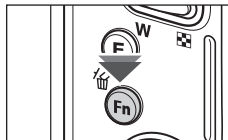

<Single Image>

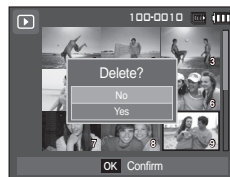

<Thumbnail Image>

2. To add images to delete, press the **T** button.
 - **Left/Right** button: Selects images
 - **T** button: Checks for deletion
 - **OK** button: Deletes the selection

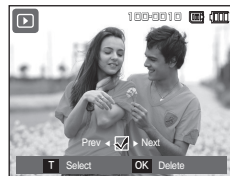

3. Select the submenu values by pressing the **Up/Down** button and then press the **OK** button.
 - If [No] is selected: Cancels "Delete Image".
 - If [Yes] is selected: Deletes the selected images.

E (Effect) button: Resize

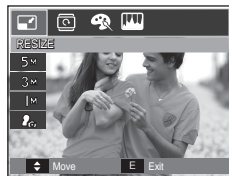

Change the resolution (size) of pictures taken. Select [Start image] to save an image to be the start-up image.

1. Press the **Play mode** button and press the **E** button.
2. Press the **Left/Right** button and select the [RESIZE] () menu tab.
3. Select a desired sub menu by pressing the **Up/Down** button and press the **OK** button.



■ Image Resize Types

(●: Selectable)

	5M	3M	1M	
13M	●	●	●	●
8M	●	●	●	●
5M		●	●	●
3M			●	●
1M				●
		4MP	2MP	
12MP		●	●	
		4MW	2MW	
10MW		●	●	

- A large sized image can be resized to a smaller sized image, but not vice versa.
- Only JPEG images can be resized. Movie clip (AVI), Voice recording (WAV) files can't be resized.
- You can change the resolution of only those files compressed in the JPEG 4:2:2 format.
- The resized image will have a new file name. The [Start Image] image is stored not on the memory card but on the internal memory.
- If a new user image is saved, one of the two user images will be deleted in order.
- If the memory capacity is insufficient to store the resized image, a [Memory Full!] message will appear on the LCD monitor and the resized image can't be stored.

E (Effect) button: Rotating an image

You can rotate the stored images by various degrees. Once the playback of the rotated picture is finished, it will switch back to the original state.

1. Press the **Play mode** button and press the **E** button.
2. Press the **Left/Right** button and select the [ROTATE] (🔄) menu tab.
3. Select a desired sub menu by pressing the **Up/Down** button.



<🔄>: Right 90°>:
Rotate picture in a clock-wise direction



<🔄>: Left 90°>:
Rotate picture in a counterclock-wise direction



<🔄>: 180°>:
Rotate picture 180 degrees



<🔄>: Horizontal>:
Rotate picture horizontally



<🔄>: Vertical>:
Rotate picture vertically

※ If you display the rotated image on the LCD monitor, empty spaces may appear to the left and right of the image.

E (Effect) button: Colour

It is possible to add colour effects to your images by using this button.

1. Press the **Play mode** button and press the **E** button.
2. Select (🎨) menu tab by pressing the **Left/Right** button.
3. Select a desired sub menu by pressing the **Up/Down** button and press the **OK** button.



Icon	Effect Mode	Description
🖼️	B/W	Captured images will be stored in black and white.
🎨	Sepia	Captured images will be stored in a sepia tone (a gradient of yellowish brown colours).
🔴	Red	Captured images will be stored in a red tone.
🟢	Green	Captured images will be stored in a green tone.
🟡	Blue	Captured images will be stored in a blue tone.
⚪	Negative	Save the image in negative mode.
🎨	Custom Color	Captured images will be stored in set RGB tone.

4. The changed image is saved as a new file name.

E (Effect) button: Colour

■ Custom colour

You can change the R(Red), G(Green) and B(Blue) values of the image.



– **OK** button: Selects / sets up the Custom Colour

– **Up/Down** button: Selects R, G, B

– **Left/Right** button: Changes the values



E (Effect) button: Image editing

1. Press the **Play** button and press the **E** button.
2. Select () menu tab by pressing the **Left/Right** button.

ACB

You can automatically adjust the brightness of the dark area, caused by under exposure to the light source.

1. Select () by pressing the **Up/Down** button and press the **OK** button.
2. The [Processing!] message is displayed and the image is saved as a new file name



Red eye removal

Red eye effect can be removed from the captured image.

1. Select () by pressing the **Up/Down** button and press the **OK** button.
2. The [Processing!] message displays and the image is saved as a new file name



E (Effect) button: Image editing

Face Retouch

When you recorded a person, you can retouch the subject's face.

1. Select (👤) by pressing the **Up/Down** button and a bar for selecting the [Face Retouch] will be displayed.
2. Change the Face Retouch by pressing the **Left/Right** button.
3. Press the **OK** button and the image will be saved as a new file name.



Contrast control

You can change the contrast of the image.

1. Select (☉) by pressing the **Up/Down** button and a bar for selecting the contrast will be displayed.
2. Change the contrast by pressing the **Left/Right** button.
3. Press the **OK** button and the image will be saved as a new file name.



Brightness control

You can change the brightness of the image.

1. Select (☀) by pressing the **Up/Down** button and a bar for selecting the brightness will be displayed.
2. Change the brightness by pressing the **Left/Right** button.
3. Press the **OK** button and the image will be saved as a new file name.



Saturation control



You can change the saturation of the image.

1. Select (🌈) by pressing the **Up/Down** button and a bar for selecting the saturation will be displayed.
2. Change the saturation by pressing the **Left/Right** button.
3. Press the **OK** button and the image will be saved as a new file name.



Setting up the play back function using the LCD monitor

Play mode functions can be changed by using the LCD monitor. In the Play mode, pressing the **MENU** button displays the menu on the LCD monitor. The menus you can set up in Play mode are as follows. To capture an image after setting up the play menu, press the **Play mode** button or **Shutter** button.

Menu Tab	Main Menu	Sub Menu	Sub Menu	Page	
MULTI SLIDE SHOW 	Show Start	Play / Repeat Play	–	p.64	
	Images	All		p.65	
		Date			
		Select			
	Effect	Off	Basic	Classic	p.66
		Memories	Rhythmic	Delight	
	Interval	1, 3, 5, 10 sec		–	p.66
Music	Off/Panorama/First smile/Remembrance		–		
PLAY BACK 	Voice Memo	Off	–	p.67	
		On	–		
	Protect	Select	Unlock/Lock	–	p.68
		All			
	Delete	Select	–	p.68–70	
		All	No/Yes		
	DPOF	Standard	Select/All Pics/Cancel	p.68–70	
		Index	No / Yes		
Size		Select/All Pics/Cancel			
Copy To Card	No	–	p.71		
	Yes	–			

This menu is available while the camera is connected to a PictBridge supporting printer (direct connection to the camera, sold separately) with a USB cable.

Menu Tab	Main Menu	Sub Menu	Sub Menu	Page
	Images	One Pic	–	p.82
		All Pics	–	
	Size	Auto	–	p.83
		PostCard	–	
		Card	–	
		4X6	–	
		L	–	
		2L	–	
		Letter	–	
		A4	–	
		A3	–	
		Auto	–	
		Full	–	
		1	–	
	2	–		
	Layout	4	–	
		8	–	
		9	–	
		16	–	
		Index	–	

Setting up the play back function using the LCD monitor

Menu Tab	Main Menu	Sub Menu	Sub Menu	Page
	Type	Auto	-	p.83
		Plain	-	
		Photo	-	
		FastPhoto	-	
	Quality	Auto	-	
		Draft	-	
		Normal	-	
		Fine	-	
	Date Print	Auto	-	
		Off	-	
		On	-	
	File Name	Auto	-	
		Off	-	
		On	-	
Reset	No	-		
	Yes	-		

× Menus are subject to change without prior notice.

Starting the slide show ()

Images can be displayed continuously at pre-set intervals. You can view the slide show by connecting the camera to an external monitor.



1. Press the **Play mode** button and press the **MENU** button.
2. Press the **Left/Right** button and select the [MULTI SLIDE SHOW] menu tab.

Start the slide show

The slide show can start only in the [Show Start] menu.

1. Use the **Up/Down** button to select the [Show Start] menu and press the **Right** button.
2. Select a desired sub menu by pressing the **Up/Down** button.
[Play]: The slide show is closed after one cycle.
[Repeat Play]: The slide show is repeated until cancelled.



3. Press the **OK** button and the slideshow will be started.
 - To pause the slide show while playing it back, press the **Play & Pause** () button again.
 - Pressing the **Play & Pause** () button again will cause the slide show to restart.
 - To stop playback of the slide show, press the **Play & Pause** () button, and then press the **OK** button.

Starting the slide show (🎮)

Selecting Images

You can select image to view.

1. Use the **Up/Down** button to select the [Images] menu and press the **Right** button.
2. Select a desired sub menu by pressing the **Up/Down** button.

[All]: All images saved in the Memory are played back.

[Date]: Images taken in a specified date are played back.

[Select]: Play only the selected images.

If you press the **Right** button, you can select the desired images to play back.

The selected image can be saved as [Select 1], [Select 2] and [Select 3]. If you save the selected image with the [New Select] command, it will be saved as [Select 1]. But when a new image is saved again using [New Select], the former image which had been saved as [Select 1] will be saved as [Select 2] automatically. You can change and cancel the images which were saved as [Select 1], [Select 2] and [Select 3].

3. Press the **OK** button and the settings are saved.

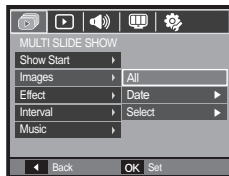

Configure slide show effects

Unique screen effects can be used for the slide show.

1. Select the [Effect] sub menu by pressing the **Up/Down** button and press the **Right** button.
2. Use the **Up/Down** button to select the type of effect.
3. Press the **OK** button to confirm the setting.

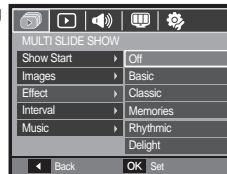

- When the effect is selected, the background music is changed according to the default setting of the effect.

Effect	Description
Off, Basic	No background music.
Classic	Background music is set to [Remembrance].
Memories	Background music is set to [Remembrance].
Rhythmic	Background music is set to [First Smile].
Delight	Background music is set to [Panorama].



- You can change the desired music for each effect.

Starting the slide show (🎮)

Setting play interval

Set the slide show play interval.

1. Select the [Interval] sub menu by pressing the **Up/Down** button and press the **Right** button.
2. Use the **Up/Down** button to select the desired interval.
3. Press the **OK** button to save the configuration.

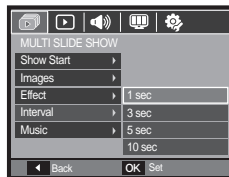

- The loading time depends on the image size and quality.
- While the slide show is playing, only the first frame of a movie file is displayed.
- While the slide show is playing, the voice recording file will not display.
- [Interval] is available when the effect is set to [Off], [Basic], [Classic] in the slide show. It is unavailable when the effect is set to [Memories], [Rhythmic], [Delight] in the slide show.

Setting Background Music

Set the slide show music.

1. Select the [Music] sub menu by pressing the **Up/Down** button and press the **Right** button.
2. Use the **Up/Down** button to select the desired Music.
3. Press the **OK** button to save the configuration.



[Off]: Background music is not played back.
[Panorama], [First smile], [Remembrance]:
Selected music is played back.

Playback (▶)

Voice memo

You can add your voice to a stored still image.



<Voice memo menu>

<Ready for recording>

<Voice is recording>

- Press the **Shutter** button to take a picture. The images are saved on the memory. After saving the image, the voice is recording for 10 seconds.
- To stop the recording, press the **Shutter** button.

Protecting images

This is used to protect specific shots from being accidentally erased (Lock). It also unprotects images that have been previously protected (Unlock).

1. Press the **Up/Down** button and select the [Protect] menu tab. And then press the **Right** button.
2. Select a desired sub menu by pressing the **Up/Down** button and press the **OK** button.

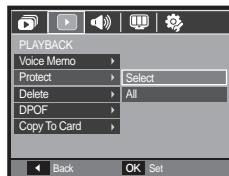

[Select]: Selection window for an image to be protected / released is displayed.

- **Up/Down/Left/Right** button: Select an image.
- **Zoom W/T** button: Protect / release the image.
- **OK** button: Your changes will be saved and the menu will disappear.

[All]: Protect / release all saved images.

- If you protect an image, the protect icon will be displayed on the LCD monitor. (An unprotected image has no indicator)
- An image in Lock mode will be protected from the delete function or [Delete] functions, but will NOT be protected from the [Format] function.

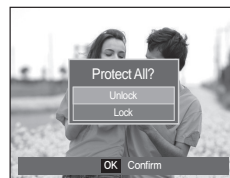
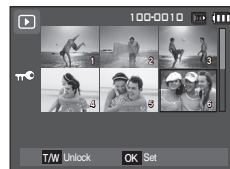

Playback (▶)

Deleting images

This deletes images stored on the memory card. By activating the Recycle Bin function (p.78) you can restore deleted photos.

1. Press the **Up/Down** button and select the [Delete] menu tab. And then press the **Right** button.
2. Select a desired sub menu by pressing the **Up/Down** button and press the **OK** button.

[Select]: Selection window for an image to delete is displayed.

- **Up/Down/Left/Right** button: Select an image.
- **Zoom T** button: Select the image for deletion. (V mark)
- **OK** button: Press the **OK** button to display the confirmation message. Select the [Yes] menu and press the **OK** button to delete marked images.

[All]: Displays confirmation window. Select the [Yes] menu and press the **OK** button to delete all unprotected images. If there are no protected images, all the images are deleted and a [No Image!] message will display.

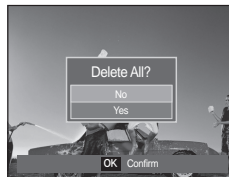
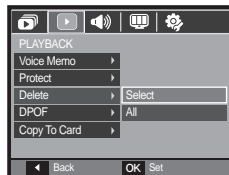

3. After deletion, the screen will be changed to the play mode screen.



- Of all the files stored in the memory card, the unprotected files in the DCIM subfolder will be deleted. Remember that this will permanently delete unprotected images. Important shots should be stored on a computer before deletion takes place. The startup image is stored in the camera's internal memory (i.e., not on the memory card) and it will not be deleted even if you delete all files on the memory card.

DPOF

- DPOF(Digital Print Order Format) allows you to embed printing information on your memory card's MISC folder. Select the pictures to be printed and how many prints to make.
- The DPOF indicator will be displayed on the LCD monitor when an image that has DPOF information plays back. Images can then be printed on DPOF printers, or at an increasing number of photo labs.
- This function is not available for movie clips and voice recording files.
- When the wide angle image is printed as a wide angle print, 8% of the left and right side of the image may not be printed. Check that your printer can support the wide angle image when you print the image. When you print the image at a photo lab, request that the image is printed as a wide angle image. (Some photo labs may not support the wide angle size print.)

Playback (▶)

■ Standard

This function allows you to embed printing quantity information on a stored image.

1. Press the **Up/Down** button and select the [DPOF] menu tab. And then press the **Right** button.
2. Press the **Right** button again and [Standard] sub menu will be displayed.

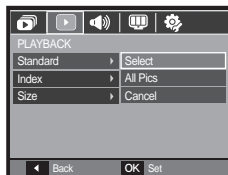

3. Select a desired sub menu by pressing the **Up/Down** button and press the **OK** button.
[Select]: Selection window for an image to print is displayed.

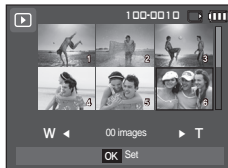

- **Up/Down/Left/Right** button: Select an image to print.
- **Zoom W/T** button: Select the number of prints.

[All Pics]: Configure number of prints for all pictures except movie and voice files.

- **Zoom W/T** button: Select a number of prints.

[Cancel]: Cancel the print setup.

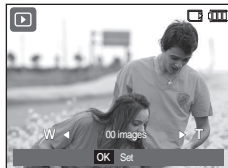

4. Press the **OK** button to confirm the setting. If an image carries DPOF instructions, the DPOF (▶) indicator will show.

■ Index

Images (except for movie clips and voice file) are printed as index type.

1. Press the **Up/Down** button and select the [DPOF] menu tab. And then press the **Right** button.
2. Press the **Right** button again and [Index] sub menu will be displayed.
3. Select a desired sub menu by pressing the **Up/Down** button.
If [No] is selected: Cancel the index print setting.
If [Yes] is selected: The image will be printed in index format.
4. Press the **OK** button to confirm the setting.



Playback (▶)

■ Print size

You can specify the print size when printing images stored on the memory card. The [Size] menu is available only for DPOF 1.1 compatible printers.

1. Press the **Up/Down** button and select the [DPOF] menu tab. And then press the **Right** button.
2. Press the **Right** button again and select the [Size] sub menu will be displayed.
3. Select a desired sub menu by pressing the **Up/Down** button and press the **OK** button.

[Select]: Selection window to change the printed size of the image is displayed.

- **Up/Down/Left/Right** button: Select an image.
- **Zoom W/T** button: Change the print size.
- **OK** button: Your changes will be saved and the menu will disappear.

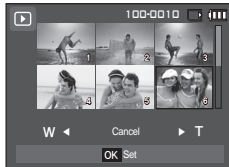
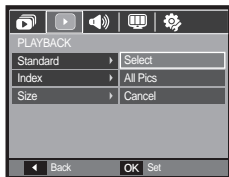

[All Pics]: Change print size of all saved images.

- **Zoom W/T** button: Select a print size.
- **OK** button: Confirm the changed setting.

[Cancel]: Cancel all of the print size settings.

- × DPOF [Size] secondary menu: Cancel, 3X5, 4X6, 5X7, 8X10

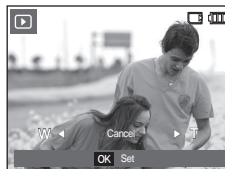

- Depending on the manufacturer and print model, cancelling the printing may take a little longer for the printer to process.

Playback (▶)

Copy To Card

This enables you to copy image files, movie clips and voice recording files to the memory card.

1. Select the [Copy To Card] menu tab by pressing the **Up/Down** button. And then press the **Right** button.
2. Select a desired sub menu by pressing the **Up/Down** button and press the **OK** button.

- [No]: Cancels [Copy To Card].
- [Yes]: All images, movie clips and voice recording files saved in the internal memory are copied to the memory card after the [Processing!] message is displayed. After copying has been completed, the screen will return to play mode.



- When this menu is selected without inserting a memory card, the [No Card!] message will be displayed.
- If there is not enough space available in the memory card to copy saved images in the internal memory (30MB), the [Copy To Card] command will copy only some of the images and display [Memory Full!] message. Then the system will return to the Playback mode. Please be sure to delete any unnecessary files to free up space before inserting the memory card into the camera.
- When you move the images that are stored in the internal memory by doing [Copy To Card] to the card, the next number of file names will be created in the card to avoid duplication of the file name.
 - When the [Reset] of the [File] setup menu is set: The copied file names start from after the last stored file name.
 - When the [Series] of the [File] setup menu is set: The copied file names start from after the last captured file name. After completing [Copy To Card], the last stored image of the last copied folder is displayed on the LCD monitor.

Sound (🔊)

Shutter Sound

You can select the shutter sound.

- [Shutter Sound] sub menu:
[Off], [Sound 1], [Sound 2], [Sound 3]

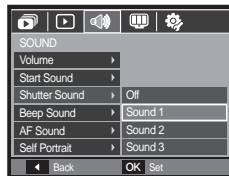

Beep Sound

If you set sound to on, various sounds will be activated for camera startup, when **OK** button is pressed, so that you can be aware of the camera operation status.

- [Beep Sound] sub menu:
[Off], [Sound 1], [Sound 2], [Sound 3]

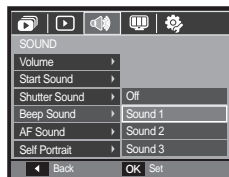

AF Sound

If you set AF sound to on, AF sound will be activated when the Shutter button is pressed down half way so that you can be aware of the camera operation status.

- [AF Sound] sub menu: [Off], [On]

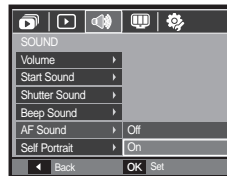

Self Portrait

This feature automatically detects the location of the face and optimises the camera settings to ensure a great self portrait.

- This feature can be set by using the [Off] and [On] buttons.

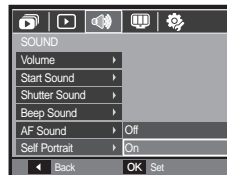



Setup menu

In this mode, you can set up basic settings. You can use the setup menu in all camera modes, except Voice recording mode.

- The items indicated by  are default settings.

Menu tab	Main menu	Sub menu			Page	
DISPLAY 	Language	ENGLISH	한국어	FRANÇAIS	p.75	
		DEUTSCH	ESPAÑOL	ITALIANO		
		简体中文	繁體中文	日本語		
		РУССКИЙ	PORTUGUÊS	DUTCH		
		DANSK	SVENSKA	SUOMI		
		ไทย	BAHASA	عربي		
		Čeština	POLSKI	Magyar		
		Türkçe	Eesti	Lietuvių		
	Latviešu	فارسی	-			
	Date&Time	yyyy/mm/dd	Off			p.75
		dd/mm/yyyy	mm/dd/yyyy			
		World Time	London	Rome, Paris, Berlin		
			Athens, Helsinki	Moscow		
			Teheran	Abu Dhabi		
			Kabul	Tashkent		
			Mumbai, New Delhi	Kathmandu		
			Almaty	Yangon		
Bangkok, Jakarta			Beijing, Hong Kong			
Seoul, Tokyo			Darwin, Adelaide			
Guam, Sydney	Okhotsk					

Menu tab	Main menu	Sub menu		Page		
DISPLAY 	Date&Time	World Time	Wellington, Auckland	Samoa, Midway	p.75	
			Honolulu, Hawaii	Alaska		
			LA, San Francisco	Denver, Phoenix		
			Chicago, Dallas	New York, Miami		
			Caracas, La Paz	Newfoundland		
			Buenos Aires	Mid-Atlantic		
			Cape Verde	-		
	Start Image	Off		Logo	p.76	
		User Image		-		
	Display Bright	Auto		Dark		
Normal		Bright				
Quick View	Off	0.5, 1, 3sec				
Display Save	Off	On				
SETTINGS 	Format	No	Yes		p.77	
	Reset	No	Yes			
	Recycle Bin	Off		On		p.78
		Recycle Folder				
	File	Reset	Series			
	Imprint	Off		Date		p.79
		Date&Time		-		
	Power Off	Off	1, 3, 5, 10min			
	Video Out	NTSC	PAL		p.80	
	AF Lamp	Off	On		p.81	

* Menus are subject to change without prior notice.

Display (📺)

Language

There is a choice of languages that can be displayed on the LCD monitor. Even if the battery is removed and inserted again, the language setting will be preserved.

- Language sub menu:

English, Korean, French, German, Spanish, Italian, S.Chinese, T.Chinese, Japanese, Russian, Portuguese, Dutch, Danish, Swedish, Finnish, Thai, Bahasa (Malay / Indonesian), Arabic, Czech, Polish, Hungarian, Turkish, Estonian, Lituianian, Latvian and Persian.



Setting up the Date / Time / Date type

You can change the date and time that will be displayed on the captured images and set up the date type. If [World Time] is set in foreign countries, the date and time of the destination will be displayed on the LCD monitor.

- Date type:[yyyy/mm/dd], [Off], [dd/mm/yyyy], [mm/dd/yyyy].

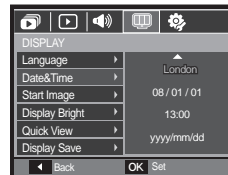

- World time
Available cities:
London, Cape Verde, Mid-Atlantic, Buenos Aires, Newfoundland, Caracas, La Paz, New York, Miami, Chicago, Dallas, Denver, Phoenix, LA, San Francisco, Alaska, Honolulu, Hawaii, Samoa, Midway, Wellington, Auckland, Okhotsk, Guam, Sydney, Darwin, Adelaide, Seoul, Tokyo, Beijing, Hong Kong, Bangkok, Jakarta, Yangon, Almaty, Kathmandu, Mumbai, New Delhi, Tashkent, Kabul, Abu Dhabi, Teheran, Moscow, Athens, Helsinki, Rome, Paris, Berlin
- [DST] (Daylight Saving Time): Press the **Up** button to set up [DST]. (🌞) icon will appear in front of the city name.



Display (📺)

Start up image

You can select the image that is first displayed on the LCD monitor whenever the camera is turned on.

- Sub menu: [Off], [Logo], [User Image]
- Use a saved image for the start-up image with the [Start Image] in the [RESIZE] menu in the play mode.
- The start-up image will not be deleted by [Delete] or [Format] menu.
- The User images will be deleted by [Reset] menu.

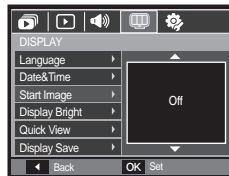

Display brightness

You can adjust the LCD brightness.

- Sub menus: [Auto], [Dark], [Normal], [Bright]

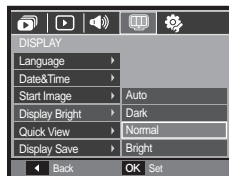

Quick view

If you enable Quick View before capturing an image, you can view the image you just captured on the LCD monitor for the duration set in the [Quick View] setup. Quick view is possible only with still images.

- Sub menu
[Off]: The quick view function can't be activated.
- [0.5, 1, 3 sec]: The captured image is briefly displayed during the selected time.

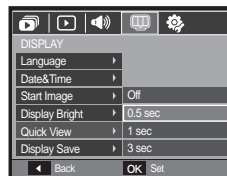

Display Save

If you set the [Display Save] to On and the camera isn't operated during the specified time, the LCD monitor will be turned off automatically.

- Sub menu
[Off]: The LCD monitor will not be turned off.
- [On]: If the camera isn't operated during the specified time (about 30 SEC.), the camera power will be idle (Camera status lamp: Blinking) automatically.

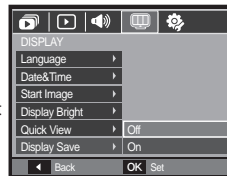

Settings (⚙️)

Formatting a memory

If you run [Format] on the memory, all files which are image, video clip and even protected images will be deleted. So be sure to download important files to your PC before formatting the memory.

- Sub menus

[No]: The memory will not be formatted.

[Yes]: A window for confirming the selection displays.

- A [Processing!] message appears and the memory will be formatted.

If you run FORMAT in Play mode, a [No Image!] message will appear.

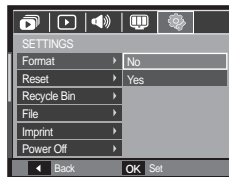

- Be sure to run [Format] on the following types of memory card.

- A new memory card, or an unformatted memory card
- A memory card that has a file this camera can't recognise or one that has been taken from another camera.
- Always format the memory card using this camera. If you insert a memory card that has been formatted using other cameras, memory card readers, or PCs, you will get a [Card Error!] message.

Initialisation

All camera menu and function settings will be restored to their default values. However, values for Date/Time, Language, and Video will not be changed.

- Sub menus

[No]: Settings will not be restored to their defaults.

[Yes]: A window to confirm the selection is displayed. Select the [Yes] menu and all settings will be restored to their defaults.

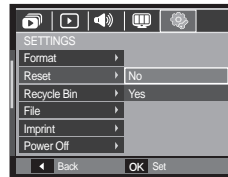

Settings (⚙️)

Recycle Bin

You can activate the [Recycle Bin] function or restore photos saved in the recycle bin. By turning on this function, you can temporarily save photos up to a total 10MB capacity. You can also restore photos from the recycle bin.

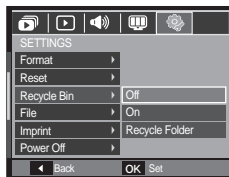

– Sub menus

[Off]: Do not want to use the Recycle Bin function.

[On]: Deleted photos are saved in the Recycle folder.

[Recycle Folder]: You can restore the deleted photos from the Recycle folder.



- The Recycle Bin function only works with photos.
- When you delete all files at once, the files are not saved in the Recycle Bin. When the Recycle bin is full of space, it removes photos in sequence from the first deleted photo.
- Although you turn off the Recycle function, the Recycle bin still keeps the photos.
- When you format the built-in/external memory, all photos in the Recycle Bin are deleted.

File name

This function allows the user to select the file naming format.

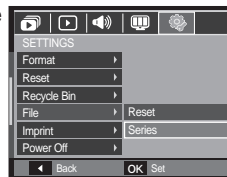

File name	Description
Reset	After using the reset function, the next file name will be set from 0001 even after formatting, deleting all or inserting a new memory card.
Series	New files are named using numbers that follow the previous sequence, even when a new memory card is used, or after formatting, or after deleting all pictures.



- The first stored folder name is 100SSCAM, and the first file name is SDC10001.
- File names are assigned sequentially from SDC10001 → SDC10002 → ~ → SDC19999.
- The folder number is assigned sequentially from 100 to 999 as follows: 100SSCAM → 101SSCAM → ~ → 999SSCAM.
- Maximum numbers of files in a folder are 9999.
- The files used with the memory card conform to the DCF (Design rule for Camera File systems) format. If you change the image file name, the image may not play back.

Settings

Imprinting the recording date

There is an option to include DATE/TIME on still images.

- Sub menus

[Off]: The DATE & TIME will not be imprinted on the image file.

[Date]: Only the DATE will be imprinted on the image file.

[Date&Time]: The DATE & TIME will be imprinted on the image file.

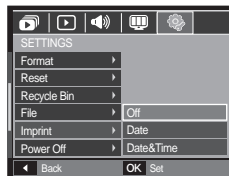

- × The Date & Time are imprinted at the bottom right side of the still image.
- × The imprint function is applied only to still images.
- × Depending on the manufacturer and print mode, the date printed on an image may not be printed correctly.

Auto power off

This function switches the camera off after a set amount of time in order to prevent unnecessary battery drainage.

- Sub menus

[Off]: Do not want to use the Power Off function.

[1, 3, 5, 10 min]: The power will turn off automatically if not used for the period of time specified.



- After replacing the battery, the [Power Off] setting will be preserved.
- Note that the automatic [Power Off] function will not operate if the camera is in the PC/Printer mode, slide show, playing back a voice recording and playing back a movie clip.

Settings (⚙️)

Selecting video out type

The Movie output signal from the camera can be NTSC or PAL. Your choice of output will be governed by the type of device (monitor or TV, etc.) to which the camera is connected. PAL mode can support only BDGHI.

■ Connecting to an external monitor

When the camera is connected to an external monitor, the image and menus on the LCD monitor will be visible on the external monitor and the LCD monitor of the camera.

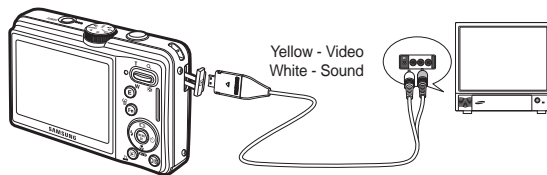

- When using a TV as an external monitor, you will need to select the external or AV channel of the TV.
- There will be a digital noise on the external monitor, but it is not a malfunction.
- If the image is not in the centre of the screen, use the TV controls to centre it.
- When the camera is connected to an external monitor, some parts of the image may not be displayed.
- When the camera is connected to an external monitor, the menu will be visible on the external monitor and the menu functions are the same as those indicated on the LCD monitor.

Selecting Video out type	Description
NTSC	U.S.A, Canada, Japan, South Korea, Taiwan, Mexico.
PAL	Australia, Austria, Belgium, China, Denmark, Finland, Germany, U.K., Holland, Italy, Kuwait, Malaysia, New Zealand, Singapore, Spain, Sweden, Switzerland, Thailand, Norway.

Settings (⚙️)

Auto focus lamp

You can turn on and off the Auto Focus lamp.

– Sub menus

[Off]: The AF lamp will not light up in low light conditions.

[On]: The AF lamp will light up in low light conditions.

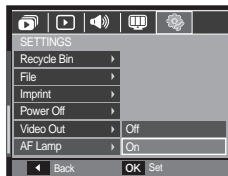

PictBridge

You can use the USB cable to connect this camera to a printer that supports PictBridge (sold separately) and print the stored images directly. Movie clips and voice files cannot be printed.

■ Setting up the camera for connection to the printer

1. Connect the camera and printer with USB cable.
2. Select the [Printer] menu by pressing **Up/Down** button and press the **OK** button.

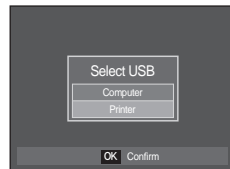

■ Connecting the Camera to a Printer

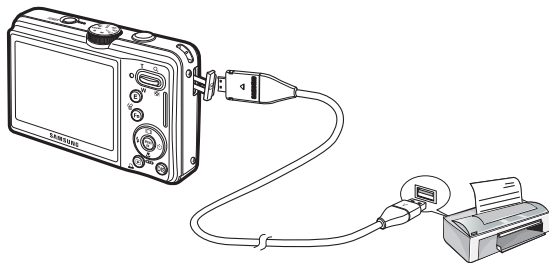

PictBridge

- × If the [USB] menu is set to the [Computer], you cannot connect a PictBridge compatible printer to the camera through USB cable with [Connecting Computer] message. In this case, remove the cable and do steps 1 and 2 again.

■ Easy printing

When you connect the camera to printer in the Play back mode, you can print a picture easily.

- Pressing the **Left/Right** button:
Selects a previous / next image.
- Pressing the **Print** (🖨️) button:
Currently displayed image will be printed with the printer's default setting.



PictBridge: Picture Selection

You can select images you want to print.

■ Setting the Number of Copies to Print

1. Press the **MENU** button and the PictBridge menu will be displayed.
2. Use the **Up/Down** button to select the [Images] menu and press the **Right** button.
3. Use the **Up/Down** button to select a desired sub menu and press the **OK** button.

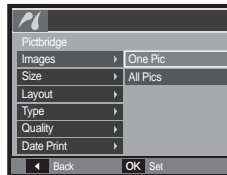

- Select [One Pic] or [All Pics]. A screen where you can set the number of copies to print will appear as shown below.

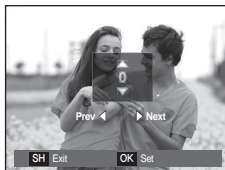

<When [One Pic] is selected>



<When [All Pics] is selected>

- Press the **Up/Down** button to select the number of prints.
 - When [One Pic] is selected: Use the **Left/Right** button to select another picture. After selecting another picture, select the number of prints for another picture.
 - After setting the number of prints, press the **OK** button to save.
 - Press the **Shutter** button to return to the menu without setting the number of prints.
4. Press the **Print** (🖨️) button and images will be printed.

PictBridge: Print Setting

You can select the Paper Size, Print Format, Paper Type, Print Quality, Date Print, and File Name Print menus for printed pictures.

1. Press the **MENU** button and the PictBridge menu will be displayed.
2. Use the **Up/Down** button to select the desired menu, and then press the **Right** button.
3. Use the **Up/Down** button to select the desired sub menu value, and then press the **OK** button.

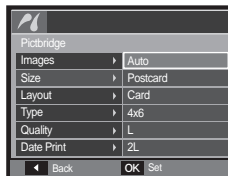

Menu	Function	Sub menu
Size	Set the size of the printing paper.	Auto, PostCard, Card, 4X6, L, 2L, Letter, A4, A3
Layout	Set the number of pictures to be printed on a sheet of paper.	Auto, Full, 1, 2, 4, 8, 9, 16, Index
Type	Set the quality of the printing paper.	Auto, Plain, Photo, FastPhoto
Quality	Set the quality of the picture to be printed.	Auto, Draft, Normal, Fine
Date Print	Set whether to print the date.	Auto, Off, On
File Name	Set whether to print the file name.	Auto, Off, On

- × Some menu options are not supported on all printers. If not supported, the menus are still displayed in the LCD, but are not selectable.

PictBridge: Reset

Initialises user-changed configurations.

1. Use the **Up/Down** button to select the [Reset] menu tab. And then press the **Right** button.
2. Use the **Up/Down** button to select the desired sub menu value, and then press the **OK** button.

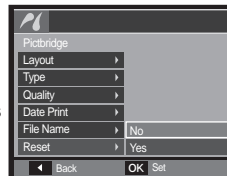

If [Yes] is selected: All print and image settings will be reset.

If [No] is selected: Settings will not be reset.

- × Default print setting varies depending on the printer manufacturer. For your printer's default setting, refer to the user's guide that came with your printer.

Software notes

Please ensure that you read the instruction manual carefully before use.

- Under no circumstances should all or part of either the software or the user manual be reproduced.
- Copyrights for software are licensed only for use with a camera.
- In the unlikely event of a manufacturing fault, we will repair or exchange your camera. We cannot, however, be held responsible in any way for damage caused by inappropriate use.
- Using a Hand-made PC or a PC and OS that has not been guaranteed by the manufacturer is not covered by the Samsung warranty.
- Before reading this manual, you should have a basic knowledge of computers and O/S (Operating Systems).

System requirements

	For Windows	For Macintosh
USB support environment	PC with processor better than Pentium III 500MHz (Pentium III 800MHz recommended) Windows 2000 / XP / Vista Minimum 256MB RAM (Over 512MB recommended)	Power Mac G3 or later, or Intel Processor Mac OS 10.3 or later Minimum 256MB RAM (Over 512MB recommended)
Software support environment	250MB of available hard-disk space (Over 1GB recommended) 1024x768 pixels, 16-bit color display compatible monitor (24-bit color display recommended) Microsoft DirectX 9.0 or later	Not supported

※ It is not compatible with Windows XP and Vista 64-bit Edition.

※ Samsung is not responsible for any defects or damages caused by the use of unauthorized computer including an assembled PC.

About the software

After inserting the CD-ROM provided with this camera into the CD-ROM drive, the following window should automatically run.



- Be sure to check the system requirements.
- You should allow 5 ~ 10 seconds for running the automatic setup program according to the capability of your computer. If the frame does not appear, run the [Windows Explorer] and select [Installer.exe] in the CD-ROM Drive root directory.

- **XviD codec:** This makes movie clips (MPEG-4) recorded with this camera play back on a PC.

To play back a movie clip recorded with this camera, you must install the XviD codec. If a movie clip recorded with this camera does not play well, install this codec. This software is only compatible with Windows.

- **Samsung Master:** This is the all-in-one multi media software solution.

You can download, view, edit and save your digital images and movie clips with this software. This software is only compatible with Windows.

Setting up the application software

To use this camera with a PC, install the application software first.

After this has been done, the stored images in the camera can be moved to the PC and can be edited by an image editing program.

- You can visit the Samsung web-site through the internet.

<http://www.samsungcamera.com>: English

<http://www.samsungcamera.co.kr>: Korean

1. The auto run frame will display. Click the [Samsung Digital Camera Installer] menu in the Auto run frame.

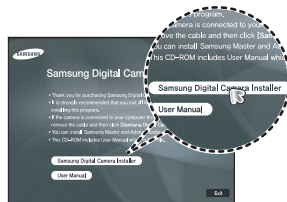

2. Install the DirectX, XviD, Samsung Master and Adobe Reader by selecting a button shown on the monitor. If a latest version of DirectX was installed on your computer, DirectX may not be installed.

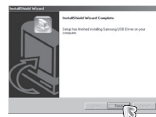

3. To play back the movie clip recorded with this camera on the computer, install the XviD codec.



- ✘ The XviD codec is distributed according to the GNU General Public License and everyone can copy, distribute and change this codec. This License applies to any program or other work which contains a notice placed by the copyright holder saying it may be distributed under the terms of this General Public License. For more information, see the License documents (<http://www.gnu.org/copyleft/gpl.html>).

Setting up the application software



4. Install the software by instructions on the monitor.

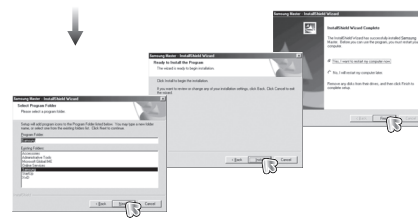

Setting up the application software

5. After restarting the computer, connect the PC to the camera with the USB cable.
6. Turn the camera power on.
The [Found New Hardware Wizard] will open and the computer will recognise the camera.
※ If your OS is Windows XP/ Vista, an image viewer program will open.

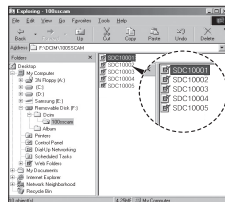

- PDF documents of user manual are included in the Software CD-ROM supplied with this camera. Search the PDF files with Windows explorer. Before opening the PDF files, you must install the Adobe Reader included in the Software CD-ROM.
- To install the Adobe Reader 6.0.1 correctly, Internet Explorer 5.01 or later has to be installed. Visit "www.microsoft.com" and upgrade the Internet Explorer.

Starting PC mode

If you connect the USB cable to a USB port on your PC and then turn on the power, the camera will automatically switch to “computer connection mode”. In this mode, you can download stored images to your PC through the USB cable.

■ Camera settings for connection

1. Turn on the camera
2. Connect the camera and computer with the supplied USB cable.
3. Turn on the computer. The camera and computer are connected.
4. External device selection menu will display on the LCD monitor.
5. Select the [Computer] by pressing the Up/Down button and press the **OK** button.

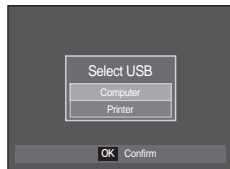

■ Connecting the camera to a PC

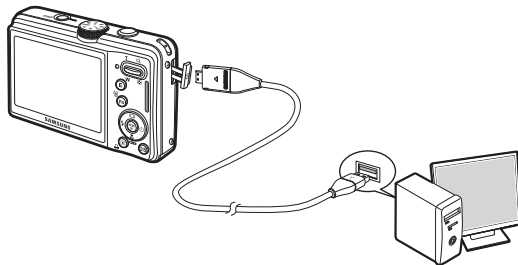

- × If you selected [Printer] in Step 5, when you connect the camera to your computer, the [Connecting Printer] message will be displayed and the connection will not be established. In this case, disconnect the USB cable, and then follow the procedure from Step 2 and onward.

■ Disconnecting the camera and PC

Refer to page 91 (Removing the removable disk).

Starting PC mode

■ Downloading stored images

You can download the still images stored on the camera to your PC's hard disk and print them or use a photo editing software to edit them.

1. Connect the camera to your PC with the USB cable.
2. On your computer's desktop display, select [My computer] and double click [Removable Disk → DCIM → 100SSCAM]. The image files will then be displayed.

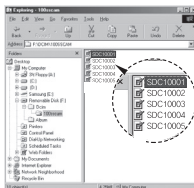

3. Select an image and press the right mouse button.

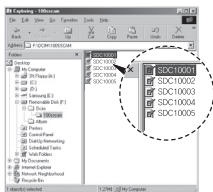

4. A pop-up menu will open.
Click the [Cut] or [Copy] menu.
 - [Cut]: cuts a selected file.
 - [Copy]: copies files.

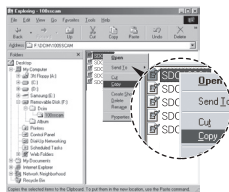

5. Click a folder where you want to paste the file.

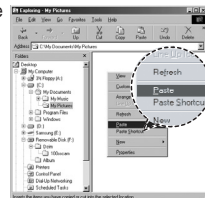

6. Press the right mouse button and a pop-up menu will open. Click [Paste].

7. An image file is transferred from the camera to your PC.

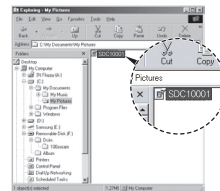

- We recommend that you should copy the images to the PC to view them. Opening images directly from the removable disk may be subject to unexpected disconnection.
- When you upload a file that is not taken by this camera to the Removable Disk, the [File Error!] message will be displayed on the LCD monitor in the Play mode, and nothing is displayed in THUMBNAIL mode.

Removing the removable disk

■ Windows 2000/XP/Vista

(The illustrations may differ from those shown depending on the Windows O/S.)

1. Check whether the camera and PC are transferring a file. If the camera status lamp blinks, please wait until the lamp has finished blinking and is constantly on.
2. Double-click the [Unplug or Eject Hardware] icon on the task bar.



Double-click!

3. The [Unplug or Eject Hardware] window will open. Select the [USB Mass Storage Device] and click the [Stop] button.

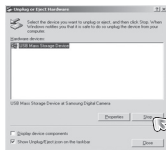

4. The [Stop a Hardware device] window will open. Select the [USB Mass Storage Device] and click the [OK] button.



5. A [Safe to Remove Hardware] window will open. Click the [OK] button.



6. A [Unplug or Eject Hardware] window will open. Click the [Close] button and the removable disk will be removed safely.



7. Unplug the USB cable.

Samsung Master

You can download, view, edit and save your images and movies with this software. This software is only compatible with Windows. To run the Samsung Master, double click the Samsung Master icon on the desktop.

■ Downloading images

1. Connect the camera to your PC.

2. A window for downloading images will display after connecting the camera to your PC.

- To download the captured images, select the [Select All] button.
- Select desired folder in the window and click the [Select All] button. You can save captured images and selected folder.
- If you click the [Cancel] button, downloading will be cancelled.

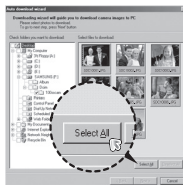

3. Click [Next >] button.

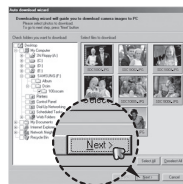

4. Select a destination and make a new folder in which to save downloaded images and folders.

- Folder names can be made in order of date and images will be downloaded.
- Folder name will be made as you want and images will be downloaded.
- After selecting a folder that was made before, images will be downloaded.

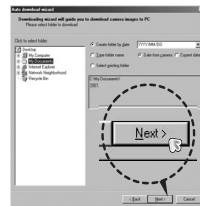

5. Click [Next >] button.

6. A window will open as shown alongside.

- The destination of the selected folder will be displayed on the upper side of the window.
- Click the [Start] button to download the images.

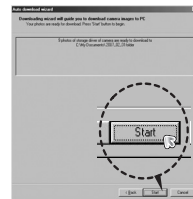

7. Downloaded images will be displayed.

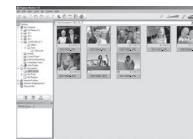

Samsung Master

- Image viewer: You can view the stored images.

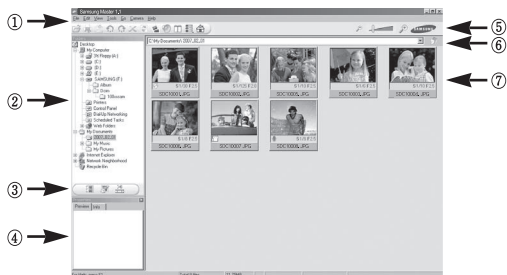

- Image viewer functions are listed below.

- ① Menu bar: You can select menus. File, Edit, View, Tools, Change functions, Auto download, help, etc.
 - ② Image selection window: You can select the desired images in this window.
 - ③ Media type selection menu: You can select image viewer, image edit and movie edit functions in this menu.
 - ④ Preview window: You can preview an image or a movie clip and check the multi media information.
 - ⑤ Zoom bar: You can change preview size.
 - ⑥ Folder display window: You can see the folder location of the selected image.
 - ⑦ Image display window: Images of the selected folder are displayed.
- × Refer to the [Help] menu in Samsung Master for further information.

- Image edit: You can edit the still image.

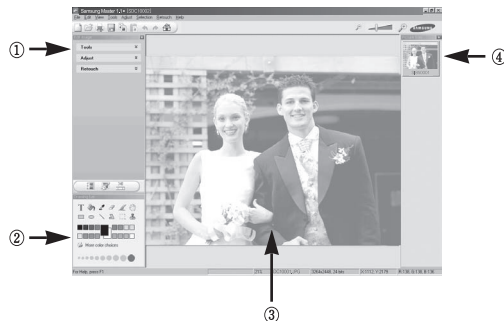

- Image edit functions are listed below.

- ① Edit menu: You can select the following menus.
 - [Tools]: You can resize or crop the selected image. See the [Help] menu.
 - [Adjust]: You can modify image quality. See the [Help] menu.
 - [Retouch]: You can change image or insert effects on the image. See the [Help] menu.
 - ② Drawing tools: Tools for editing an image.
 - ③ Image display window: A selected image is displayed in this window.
 - ④ Preview window: You can preview the changed image.
- × A still image edited with Samsung Master can't be played back on the camera.
 - × Refer to the [Help] menu in Samsung Master for further information.

Samsung Master

- **Movie edit:** You can get the still image, movie clip, narration, music files together in a movie clip.



- ② **Frame display window:** You can insert multi media in this window.
- ✗ Some movie clips that were compressed with a codec that is not compatible with the Samsung Master cannot be played back.
- ✗ Refer to the [Help] menu in Samsung Master for further information.

– Movie clip edit functions are listed below.

- ① **Edit menu:** You can select the following menus.
 - [Add Media]: You can add other media elements to a movie.
 - [Edit Clip]: You can change the brightness, contrast, colour and saturation.
 - [Effects]: You can insert an effect.
 - [Set Text]: You can insert texts.
 - [Narrate]: You can insert a narration.
 - [Produce]: You can save the edited multi media as a new file name. You can select AVI, Windows media (wmv) and Windows media (asf) file types.

Setting up the USB Driver for MAC

1. A USB Driver for MAC is not included with the software CD as MAC OS supports the camera driver.
2. Check the MAC OS version during start-up. This camera is compatible with MAC OS 10.3 or later.
3. Connect the camera to the Macintosh and turn the camera power on.
4. A new icon will be displayed on the desktop after connecting the camera to the MAC.

Using the USB Driver for MAC

1. Double click a new icon on the desktop and the folder in the memory will be displayed.
2. Select an image file and copy or move it to MAC.



- First complete uploading from computer to camera and then remove the removable disk with the Extract command.

Specifications

- Image Sensor**
- Type: 1/1.72" CCD
 - Effective Pixel: Approx. 13.6 Mega-pixel
 - Total Pixel: Approx. 13.9 Mega-pixel

- Lens**
- Focal Length: Samsung lens f = 6.0 ~ 21.6mm (35mm film equivalent: 28~102 mm)
 - F No.: F2.8(W) ~ F5.7(T)
 - Digital Zoom:
Still Image mode: 1.0X ~ 5.0X
Play mode: 1.0X ~ 13.2X (depends on image size)

- LCD Monitor**
- 2.7" color TFT LCD (230,000 pixel)

- Focusing**
- Type: TTL auto focus (Multi-AF, Center AF, Face Detection AF)
 - Range

	Normal	Macro	Auto Macro
Wide	80cm ~ Infinity	5cm ~ 80cm	5cm ~ Infinity
Tele		50cm ~ 80cm	50cm ~ Infinity

- Shutter**
- Speed 1 ~ 1/1,500 sec. (Manual: 8 ~ 1/1,500 sec.)
 - AEB, Continuous : 1/4 ~ 1/1,500 sec.

- Exposure**
- Control: Program AE
 - Metering: Multi, Spot, Center-weighted, Face Detection AE
 - Compensation: ± 2 EV (1/3EV steps)
 - ISO: Auto, 80, 100, 200, 400, 800, 1600, 3200 (Selectable 3M or under)

- Flash**
- Modes: Auto, Auto & Red-eye reduction, Fill-in flash, Slow sync, Flash off, Red-eye Fix
 - Range: Wide: 0.5 ~ 4.6m, Tele: 0.5 ~ 2.3 m (ISO Auto)
 - Recharging Time: Approx. under 4 seconds (new battery)

- Shake Reduction**
- Dual IS (OIS + DIS)
* OIS (Optical Image Stabilization), DIS (Digital Image Stabilization)

- Sharpness**
- Soft+, Soft, Normal, Vivid, Vivid+

- White Balance**
- Auto, Daylight, Cloudy, Fluorescent_H, Fluorescent_L, Tungsten, Custom

- Voice Recording**
- Voice Recording (max 10 hours)
 - Voice Memo in Still Image (max. 10 sec.)

- Date Imprinting**
- Date, Date & Time, Off (user selectable)

- Shooting**
- Still Image
 - Mode: Auto, Program, Manual, Dual IS, Photo Help Guide, Beauty Shot, Scene
 - × Scene: Nightscene, Portrait, Children, Landscape, Text, Close-up, Sunset, Dawn, Backlight, Fireworks, Beach & Snow
 - Shooting: Single, Continuous, AEB, Motion Capture
 - Self-timer: 2 sec., 10 sec., Double (10 sec, 2 sec), Motion Timer

Specifications

- Movie Clip
 - With Audio or without Audio (user selectable, recording time : Memory capacity dependent, max 2hours)
 - Size: 800x592(20FPS), 640x480 (30FPS,15FPS), 320x240(30FPS, 15FPS)
 - Frame rate: 15FPS, 20FPS, 30FPS
 - Optical Zoom up to 3.6X (Sound goes mute when operating the zoom function)
 - Movie Editing (Embedded):
Movie Stabilization, Pause during recording, Still Image Capture Time Trimming

Storage

- Media
 - Internal memory: 30MB
 - External Memory (Optional)
MMC Plus (Up to 2GB, guaranteed, 4bit 20MHz)
SD (up to 4GB guaranteed)
SDHC (up to 8GB guaranteed)
 - * Internal memory capacity is subject to change without prior notice.
- File Format
 - Still Image: JPEG (DCF), EXIF 2.21, DPOF 1.1, PictBridge 1.0
 - Movie Clip: AVI (MPEG-4)
 - Audio: WAV

- Image Size and Capacity (1GB Size)

	13M	12M	10M	8M	5M	3M	1M
	4224x3168	4224x2816	4224x2376	3264x2448	2592x1944	2048x1536	1024x768
Super Fine	147	167	199	246	379	601	1876
Fine	284	315	384	462	720	1067	2814
Normal	418	465	547	680	1015	1510	2948

× These figures are measured under Samsung standard conditions and may vary depending on shooting conditions and camera settings.

E Button

- Recording Effect:
Color Effect: Normal, B&W, Sepia, Red, Blue, Green, Negative, Custom Color
Image Adjust: Saturation, Contrast, Sharpness
- Playback Effect:
Image Edit: Resize, Rotate, Trimming
Color Effect: Normal, B&W, Sepia, Red, Blue, Green, Negative, Custom Color
Image Adjust: ACB, Red Eye Fix, Brightness, Contrast, Saturation, Face Retouch

Image Play

- Single image, Thumbnails, Slide show, Movie clip
* Slide show : Slide show with Effect & Music

Specifications

Interface	<ul style="list-style-type: none">– Digital output connector: USB 2.0 High Speed 20 pin connector– Audio: Mono (Speaker), Stereo (Microphone)– Video output: NTSC, PAL (user selectable)– DC Adapter: 4.2V, 20 pin connector
Power Source	<ul style="list-style-type: none">– Rechargeable battery: SLB-10A, 3.7V (1,050mAh)– Adaptor: SAC-47, SUC-C3× Included battery may vary depending on sales region.
Dimensions (WxHxD)	<ul style="list-style-type: none">– 91.6 X 61 X 22.95mm (excluding protrusions)
Weight	<ul style="list-style-type: none">– 138g (without batteries and card)
Operating Temperature	<ul style="list-style-type: none">– 0 ~ 40°C
Operating Humidity	<ul style="list-style-type: none">– 5 ~ 85%
Software	<ul style="list-style-type: none">– Application: Samsung Master, Adobe Reader

- × Specifications are subject to change without prior notice.
- × All trademarks are the property of their respective owners.

Important notes

Be sure to observe the following precautions!

- This unit contains precision electronic components. Do not use or store this unit in the following locations.
 - Areas exposed to extremes of in temperature and humidity.
 - Areas exposed to dust and dirt.
 - Areas exposed to direct sunlight or the inside of a vehicle in hot weather.
 - Environments where there is high magnetism or excessive vibration.
 - Areas with high explosives or highly flammable materials.
- Do not leave this camera in places subject to dust, chemicals (like naphthalene and mothballs), high temperature and high humidity. Keep this camera with silica gel in a hermetically sealed box when not planning to use the camera for a long period of time
- Sand can be particularly troublesome to cameras.
 - Do not let sand get inside the camera when using it on beaches, coastal dunes, or other areas where there is lots of sand.
 - Doing so may result in failure or may permanently render the camera unusable.
- Handling the camera
 - Never drop the camera or subject it to severe shocks or vibrations.
 - Protect the large size LCD monitor from an impact. When this camera is not used, keep it in the camera case.
 - Avoid obstructing the lens or the flash when you capture an image.

Important notes

- This camera is not waterproof. To avoid dangerous electrical shocks, never hold or operate the camera with wet hands.
- If you use this camera in wet places, such as beach or pool, do not let water or sand get inside the camera. Doing so may result in failure or may permanently damage the unit.
- **Extremes in temperature may cause problems.**
 - If the camera is transferred from a cold to a warm and humid environment, condensation can form on the delicate electronic circuitry. If this occurs, turn the camera off and wait for at least 1 hour until all moisture is dispersed. Moisture built up can also occur on the memory card. If this happens, turn off the camera and remove the memory card. Wait until the moisture has dispersed before replacing the card in the camera.
- **Caution on Using the Lens**
 - If the lens is subjected to direct sunlight, it could result in the discoloration and deterioration of the image sensor.
 - Take care not to get fingerprints or foreign substances on the surface of the lens.
- **If the digital camera is not used for a long period, an electric discharge can occur. It is a good idea to remove the battery and the memory card if you do not intend using the camera for an extended period of time.**
- **If the camera is exposed to electronic interference, it will turn itself off to protect the memory card.**
- **Camera Maintenance**
 - Use a soft brush (available from photo stores) to gently clean the lens and LCD assemblies. If this does not work, lens-cleaning paper with lens cleaning fluid can be used. Clean the camera body with a soft cloth. Do not allow this camera to come into contact with solvent materials such as benzol, insecticide, thinners etc. This may damage the body shell of the camera and also affect its performance. Rough handling can damage the LCD monitor. Take care to avoid damage and keep the camera in its protective carry case at all times when not in use.
- **Do not attempt to disassemble or modify the camera.**
- **Under certain conditions, static electricity can cause the flash unit to fire. This is not harmful to the camera and is not a malfunction.**
- **When images are uploaded or downloaded, the data transfer may be affected by static electricity. In this case, disconnect and re-connect the USB cable before trying the transfer again.**
- **Before an important event or going on a trip, you should check the camera condition.**
 - Take a picture for testing the camera condition and prepare extra battery.
 - Samsung cannot be held responsible for camera malfunctions.

Warning indicator

There are several warnings that may appear on the LCD display.

[Card Error !]

- Memory card error.
 - Turn off the camera power and turn it on again.
 - Insert the memory card again.
 - Insert and format the memory card. (p.77)

[Card Locked!]

- The memory card is locked.
 - SD/SDHC memory card: Slide the write protect switch to the top of the memory card.

[No Card!]

- A memory card is not inserted.
 - Insert the memory card.
 - Turn off the camera power and turn it on again.

[No Image!]

- There are no images stored on the memory.
 - Take images.
 - Insert a memory card that is holding some images.

[File Error!]

- File error.
 - Delete the file.
- Memory card error.
 - Contact a camera service centre.

[Low Battery!]

- There is low battery capacity.
 - Insert fresh batteries.

[Low Light!]

- When taking pictures in dark places.
 - Take pictures in Flash Photography mode.

[Out of Number]

- When selecting too many printing pages in the PictBridge menu.
 - Select printing page within the limitation.

[DCF Full Error]

- Violation of DCF format.
 - Copy the images to a PC and format the memory.

Before contacting a service centre

Please check the following.

The camera doesn't switch on.

- There is low battery capacity.
 - Insert fresh batteries. (p.15)
- Battery is inserted incorrectly with the polarities reversed.
 - Insert the battery according to the polarity marks (+, -).

The camera power ceases while in use.

- The battery is exhausted.
 - Insert a fully charged battery.
- The Camera is turned off automatically.
 - Turn on the camera power again.
- Operation has ceased in a low temperature outside of the camera usage temperature range.
 - Remove the batteries from the camera. Warm the camera and battery by placing them in your pocket and then immediately before shooting, place the battery in the camera and then shoot.

The camera suddenly stops working while in use.

- The camera stopped due to a malfunction.
 - Remove /re-insert battery and switch the camera on.

The camera buttons do not operate.

- Camera malfunction.
 - Remove/re-insert battery and switch the camera on.

Camera does not take images when pressing the Shutter button.

- There is insufficient memory capacity.
 - Delete unnecessary image files.
- The memory card has not been formatted.
 - Format the memory card (p.77).
- The memory card is exhausted.
 - Insert a new memory card.
- The memory card is locked.
 - Refer to [Card Locked!] error message.
- The camera's power is off.
 - Turn the camera power on.
- The battery is exhausted.
 - Insert fresh batteries. (p.15)
- Battery is inserted incorrectly with the polarities reversed.
 - Insert the battery according to the polarity marks (+, -).

The images are unclear.

- A picture was taken of a subject without setting an appropriate macro mode.
 - Select an appropriate macro mode to take a clear image.
- Taking a picture beyond the flash range.
 - Take a picture within the flash range.
- The lens is smudged or dirty.
 - Clean the lens.

Before contacting a service centre

The flash does not fire.

- Flash off mode has been selected.
 - Dis-engage flash off mode.
- The camera mode can't use the flash.
 - Refer to the FLASH instruction. (p.32-33)

Incorrect date and time is displayed

- The date and time have been set incorrectly or the camera has adopted the default settings.
 - Reset the date and time correctly.

A card error has occurred while the memory card is in the camera.

- Incorrect memory card format.
 - Re-format the memory card.

The images don't play back.

- Incorrect file name. (Violation of DCF format)
 - Do not change the image file name.

Colour of image is different to the original scene.

- White balance or effect setting is incorrect.
 - Select appropriate White balance and effect.

Images are too bright.

- Exposure is excessive.
 - Reset exposure compensation.

Image distortion appears in the picture.

- The camera you have purchased uses a wide angle lens and this may cause image distortion. This is a special feature of the product.

No image on external monitor.

- The external monitor has not been connected properly with the camera.
 - Check the connection cables.
- There are incorrect files in the memory card.
 - Insert a memory card that has correct files.

When using the PC's explorer, the [Removable Disk] file does not show.

- Cable connection is incorrect.
 - Check the connection.
- The camera is off.
 - Turn the camera on.
- The operating system is not Windows 2000, XP, Vista / Mac OS 10.3. Alternatively the PC does not support USB.
 - Install Windows 2000, XP, Vista / Mac OS 10.3 to PC that supports USB.
- The camera driver is not installed.
 - Install a [USB Storage Driver].

FAQ

Please check the following if the USB connection malfunctions.

Case 1

- USB cable is not connected or it is not the supplied USB cable.
- Connect the supplied USB cable.

Case 2

- The camera is not recognised by your PC.
Sometimes, the camera may appear under [Unknown Devices] in Device Manager.
- Install the camera driver correctly. Turn off the camera, remove the USB cable, plug in the USB cable again, and then turn on the camera.

Case 3

- There is an unexpected error during file transfer.
- Turn the camera power off and on again. Transfer the file again.

Case 4

- When using the USB hub.
- There may be a problem in connecting the camera to the PC through the USB hub if the PC and the hub are not compatible. Wherever possible, connect the camera to the PC directly.

Case 5

- Are other USB cables connected to the PC?
- The camera may malfunction when it is connected to the PC at the same time as another USB cable. In this case, disconnect the other USB cable, and connect only one USB cable to the camera.

Case 6

- When I open the Device Manager (by clicking Start → (Settings) → Control Panel → (Performance and Maintenance) → System → (Hardware) → Device Manager), there are Unknown Devices or Other Devices entries with a yellow question mark(?) beside them or devices with an exclamation mark(!) beside them.
- Right-click on the entry with the question (?) or exclamation (!) mark and select "Remove". Restart the PC and connect the camera again.

Case 7

- In some security programs (Norton Anti Virus, V3, etc.), the computer may not recognise the camera as a removable disk.
- Stop the security programs and connect the camera to the computer. Refer to the security program instructions about how to temporarily disable the program.

Case 8

- The camera is connected to the USB port located on the front of the computer.
- When the camera is connected to the USB port located on the front of the computer, the computer may not recognise the camera. Connect the camera to the USB port located on the back of the computer.

FAQ

When the movie clip doesn't play back on the PC

- × When the movie clip recorded by the camera doesn't play back on the PC, the causes are mostly due to the codec installed on the PC.

■ When codec for play back the movie clip isn't installed

→ Install the codec as listed below.

[Installing codec for Windows]

→ Installing the XviD codec

- 1) Insert the CD provided with the camera.
 - 2) Run the windows explorer and select [CD-ROM drive:\XviD] folder and click the XviD-1.1.2-01112006.exe file.
- × The XviD codec is distributed according to the GNU General Public License and everyone can copy, distribute and change this codec. This License applies to any program or other work which contains a notice placed by the copyright holder saying it may be distributed under the terms of this General Public License. For more information, see the License documents (<http://www.gnu.org/copyleft/gpl.html>).

[Installing codec for Mac OS]

- 1) Visit the following site for downloading the codec. (<http://www.divx.com/divx/mac>)
 - 2) Click the [Free Download] menu on the top right side of the window then download windows appears.
 - 3) Check the version of Mac OS and click the [Download] button to download the file and save it on a desired folder.
 - 4) Run the downloaded file and the codec for playing back the movie clip will be installed.
- × If the movie file is not played back on the Macintosh OS, use a media player that supports Xvid codec (e.g: Mplayer).

■ When the DirectX 9.0 or later is not installed

→ Install the DirectX 9.0 or later

- 1) Insert the CD provided with the camera
- 2) Run the windows explorer and select the [CD-ROM drive:\ USB Driver\DirectX 9.0] folder and click the DXSETUP.exe file. The DirectX will be installed. Visit the following site for downloading the DirectX.<http://www.microsoft.com/directx>

FAQ

- If a PC connected with the camera stops responding while Windows is starting.
 - In this case, disconnect the PC and the camera and Windows will start. If the problem happens continuously, set the Legacy USB Support to disable and re-start the PC. The Legacy USB Support is in the BIOS setup menu. (The BIOS setup menu differs from the PC manufacturers and some BIOS menus don't have Legacy USB Support) If you can't change the menu by yourself, contact to the PC manufacturer or BIOS manufacturer.
- If the movie clip can't be deleted, or the removable disk can't be extracted or an error message displays during the file transfer.
 - If you install only the Samsung Master, the problems mentioned above occasionally happen.
 - Close the Samsung Master program by clicking the [Samsung Master] icon on the Taskbar.
 - Install all the application programs included in the software CD.

Correct Disposal of This Product



Correct Disposal of This Product (Waste Electrical & Electronic Equipment)

(Applicable in the European Union and other European countries with separate collection systems) This marking shown on the product or its literature, indicates that it should not be disposed of with other household wastes at the end of its working life.

To prevent possible harm to the environment or human health from uncontrolled waste disposal, please separate this from other types of wastes and recycle it responsibly to promote the sustainable reuse of material resources. Household users should contact either the retailer where they purchased this product, or their local government office, for details of where and how they can take this item for environmentally safe recycling. Business users should contact their supplier and check the terms and conditions of the purchase contract. This product should not be mixed with other commercial wastes for disposal.



Samsung Techwin cares for the environment at all product manufacturing stages to preserve the environment, and is taking a number of steps to provide customers with more environment-friendly products. The Eco mark represents Samsung Techwin's will to create environment-friendly products, and indicates that the product satisfies the EU RoHS Directive.

Correct disposal of batteries in this product



(Applicable in the European Union and other European countries with separate battery return systems.)

This marking on the battery, manual or packaging indicates that the batteries in this product should not be disposed of with other household waste at the end of their working life. Where marked, the chemical symbols Hg, Cd or Pb indicate that the battery contains mercury, cadmium or lead above the reference levels in EC Directive 2006/66. If batteries are not properly disposed of, these substances can cause harm to human health or the environment.

To protect natural resources and to promote material reuse, please separate batteries from other types of waste and recycle them through your local, free battery return system.

The rechargeable battery incorporated in this product is not user replaceable. For information on its replacement, please contact your service provider.



Please refer to the warranty that came with the product you purchased,
or go to our website <http://www.samsungcamera.com/> for after-sales service or inquiries.

Internet address - <http://www.samsungcamera.com>



The CE Mark is a Directive conformity
mark of the European Community (EC)