



Oben®

MVH-4490

Mini Video Head with 90° Vertical Tilt



You're on steady ground®

Thank you for choosing Oben

The Oben MVH-4490 Mini Video Head provides smooth panning and tilting for small cameras and camcorders weighing up to 4.4 pounds. Perfect for shooting with a desktop tripod like the Oben CTT-1000, the head features independent adjustment for full 360° panning and +90° to -80° tilt.

The head is designed with a 90° vertical tilt feature that allows you to quickly switch the camera from landscape to portrait orientation. The fluid-type drag system and spring-loaded tilt counterbalance ensures smooth and even camera movement. An Arca-style quick-release plate is included for speedy camera mounting and swapping.

**Warnings:**

- *Please read and follow these instructions, and keep this manual in a safe place.*
- *Do not exceed the tripod's maximum load capacity.*
- *Ensure that all appropriate locks are engaged when necessary.*
- *The video head should be used only in temperatures between -22°F and 140°F.*
- *Do not operate in salt water. Dry the video head if it becomes wet.*
- *Remove the camera from the head during setup or transport.*
- *All images are for illustrative purposes only.*

Visit our website at **ObenSupports.com**
for more Oben products.

OVERVIEW

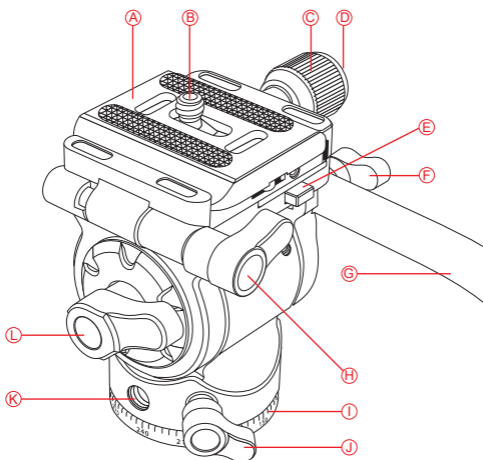

- | | |
|--------------------------------|----------------------------|
| Ⓐ Quick-release plate | Ⓒ Pan arm |
| Ⓑ 1/4-20 mounting screw | Ⓓ Vertical tilt knob |
| Ⓒ Quick-release knob | Ⓔ Panning base scale |
| Ⓓ Bubble level | Ⓕ Pan knob |
| Ⓔ Vertical tilt release button | Ⓖ 1/4-20 accessory sockets |
| Ⓕ Pan arm attachment screw | Ⓖ Tilt knob |

Mounting the Head to a Tripod

CONVERTING THE MOUNTING THREAD

The MVH-4490 has a 3/8-16 mounting socket. For tripods with a 1/4-20 mounting stud, screw the included 3/8-16 to 1/4-20 reducer bushing into the head's mounting socket.

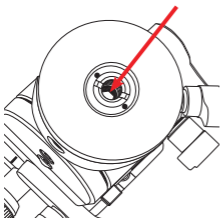

MOUNTING THE HEAD

Tighten the pan knob, and then rotate the head onto the tripod's mounting stud. Tighten the head until secure.

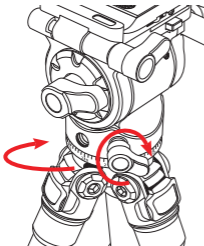

Mounting the Quick-Release Plate

The quick-release plate uses a 1/4-20 screw that's compatible with most cameras and camcorders.

1. Loosen the quick-release knob, and lift the quick-release plate off the head.
2. Screw the quick-release plate into your camera's tripod socket. Use the D-Ring, slotted screwdriver, or coin to tighten the screw.

Warning: Some manufacturers' quick-release plates do not meet our specifications and may not lock your equipment securely in the Oben MVH-4490. Make sure to test any non-Oben camera and lens plates to ensure compatibility.

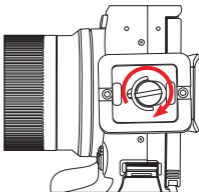
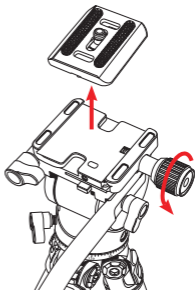

Mounting the Camera

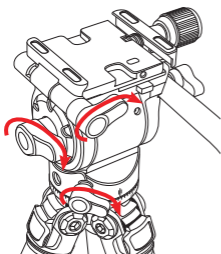

1. Tighten all the knobs except the quick-release knob.
2. Insert one side of the quick-release plate into side of the clamp opposite the quick-release knob. Then lower the other side of the plate into the clamp until the plate is fully seated.

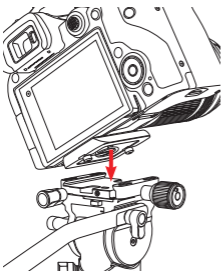

3. Adjust the position of the quick-release plate to ensure the best balance for your camera, and tighten the quick-release knob until the plate is secure.

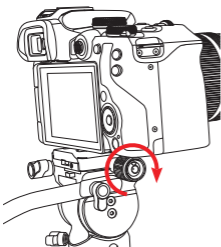

Important: When changing camera positions via the quick-release knob, always keep one hand on the camera.

Tilt Control

1. Loosen the tilt knob to set the head to the desired angle. Tighten the tilt knob until secure.
2. Loosen the tilt knob to tilt your camera while you're shooting.

When the tilt knob is loosened, a spring-loaded counterbalance will allow smoother tilting.

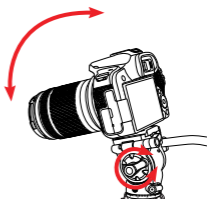
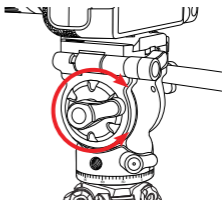

Pan Control

1. Loosen the pan knob to pan change the lateral position. The built-in fluid-type drag ensures smooth and even camera movement.
2. Tighten the pan knob to set the position of the camera.

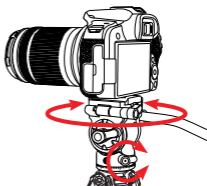
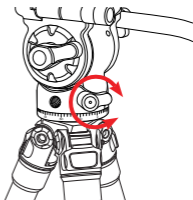

Vertical Tilt

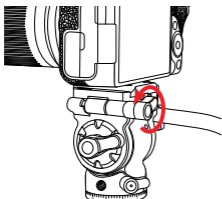

The vertical tilt features let you quickly switch the camera from portrait to landscape orientation.

1. Loosen the vertical tilt knob.

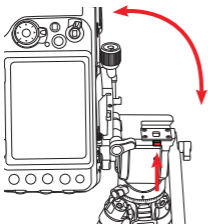

2. Press the vertical tilt release button, and lift the quick-release plate to the 90° position.

3. Tighten the vertical tilt knob to secure the camera's position.

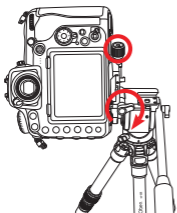

LEVELING THE CAMERA

The bubble level at the end of the quick-release knob allows you to level the camera when you switch it to vertical orientation.

Specifications

| | |
|--------------------------------|--------------------------|
| Head Type | Video |
| Base Mount | 3/8-16 thread |
| Quick-Release Type | Arca |
| Load Capacity | 4.4 lb. (2 kg) |
| Number of Bubble Levels | 1 |
| Friction Control | Yes |
| Tilt Angle | -80° to +90° |
| Independent Pan Lock | Yes |
| Base Diameter | 1.5 in. (3.8 cm) |
| Pan Arm Length | 8.6 in. (21.8 cm) |
| Height | 2.9 in. (7.4 cm) |
| Weight | 14.5 oz. (411 g) |

Five-Year Limited Warranty

This Oben product is warranted to the original purchaser to be free from defects in materials and workmanship under normal consumer use for a period of five (5) years from the original purchase date or thirty (30) days after replacement, whichever occurs later. The warranty provider's responsibility with respect to this limited warranty shall be limited solely to repair or replacement, at the provider's discretion, of any product that fails during normal use of this product in its intended manner and in its intended environment. Inoperability of the product or part(s) shall be determined by the warranty provider. If the product has been discontinued, the warranty provider reserves the right to replace it with a model of equivalent quality and function. This warranty does not cover damage or defect caused by misuse, neglect, accident, alteration, abuse, improper installation or maintenance. EXCEPT AS PROVIDED HEREIN, THE WARRANTY PROVIDER MAKES NEITHER ANY EXPRESS WARRANTIES NOR ANY IMPLIED WARRANTIES, INCLUDING BUT NOT LIMITED TO ANY IMPLIED WARRANTY OF MERCHANTABILITY OR FITNESS FOR A PARTICULAR PURPOSE. This warranty provides you with specific legal rights, and you may also have additional rights that vary from state to state. To obtain warranty coverage, contact the Oben Customer Service Department to obtain a return merchandise authorization ("RMA") number, and return the defective product to Oben along with the RMA number and proof of purchase. Shipment of the defective product is at the purchaser's own risk and expense.

For more information or to arrange service, visit www.obensupports.com or call Customer Service at 212-594-2353.



Product warranty provided by the Gradus Group.
www.gradusgroup.com



www.obensupports.com

Oben is a registered trademark of the Gradus Group.
© 2022 Gradus Group LLC. All Rights Reserved.