



Instruction Manual

Firmware

**R007**

# eMotimo spectrum ST4



V 1.1

# Contents Page

*At any time, press the eMotimo or spectrum logo in the footer to come back to the contents page*

Table of contents	
Contents Page.....	2
Getting started.....	3
For Your Safety.....	4
What's Included in basic bundles .....	5
spectrum ST4 Hardware Map.....	6
spectrum ST4 Electronics Map.....	7
Hardware Setup.....	8
Connections / Ports .....	9
Powering spectrum ST4 .....	10
Controller.....	11
Remote LED Flash Indications .....	12
Remote Information .....	13
Screen Map .....	14
Screen Map .....	15
Live Motion - Motor Preset (feel) .....	16
Live Motion - Motor Preset (feel) .....	19
Live Motion - Experimental .....	20
Live Motion - Experimental .....	21
Live Motion - Experimental .....	22
Programmed moves .....	23
Using an external intervalometer.....	27
Photo Tools.....	28
Settings.....	34

## Resources and Customer Services

Instructional videos - <https://vimeopro.com/emotimo/spectrum-instructional-videos>

Support website / ticket creation: <http://support.emotimo.com>

Support email: [help@emotimo.com](mailto:help@emotimo.com)

# Getting started

## Welcome to your eMotimo spectrum ST4!

Thank you for purchasing a spectrum ST4. Whether you choose to use the basic functionality of the spectrum for programmed moves, or push the limits with brand new features never seen in motion control, we are happy to have you as a customer.

A statement of warning/caution/excitement if you are used to other motion control: **The spectrum ST4 is going to push what is possible with motion control. It will push you in the process if you let it.**

Please take the time to play to review our instruction videos online: <https://vimeopro.com/emotimo/spectrum-instructional-videos>

Please also, read this guide to understand the extent of what is possible with the spectrum. If you do, you will know how to use the most powerful piece of portable motion control on the market.

Brian Burling – eMotimo founder

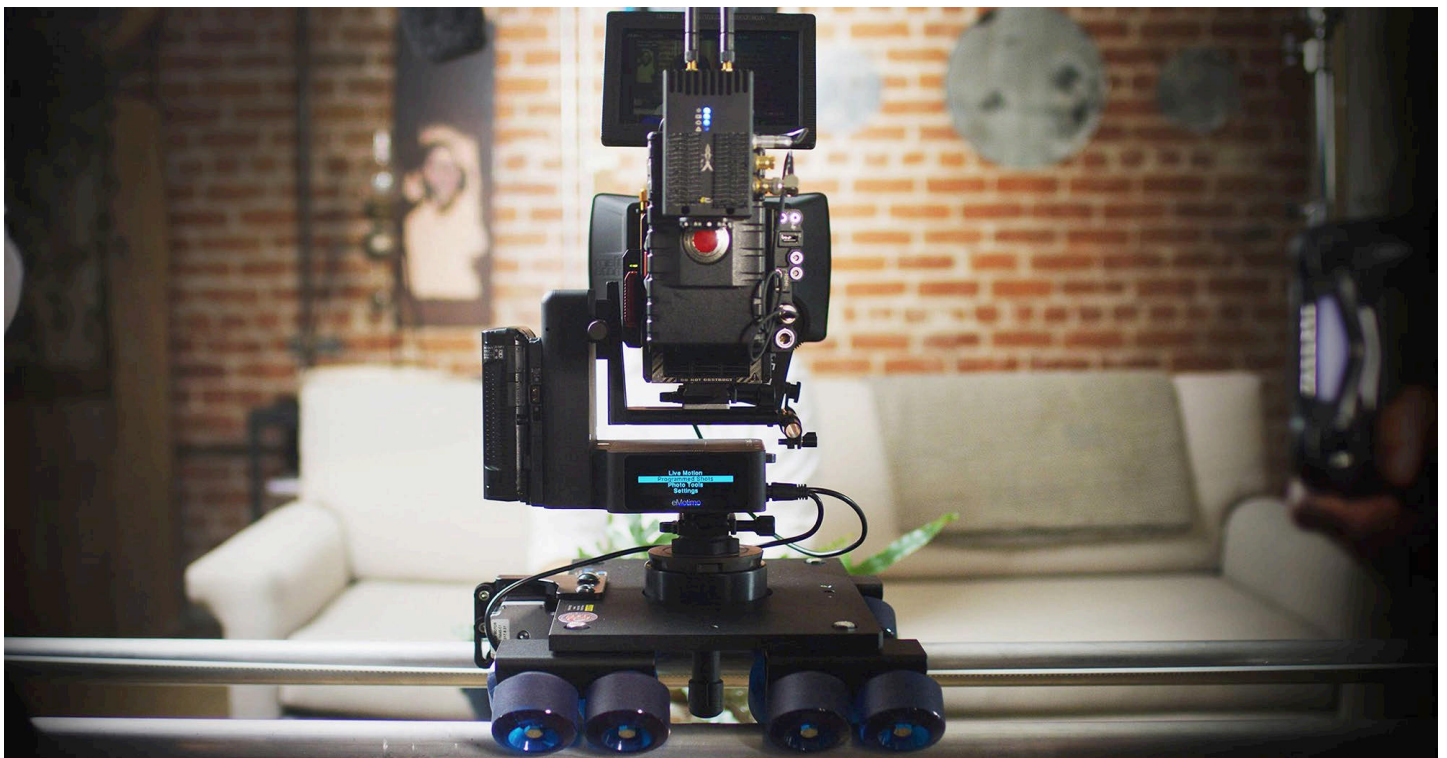



# For Your Safety

## Please read and observe the following precautions

**To prevent damage to the spectrum ST4 and/or personal injury to yourself:**

### **Do not disassemble the unit**

This unit is a complex electronic device and contains no user-serviceable parts. Any unauthorized disassembly or modification may void the service warranty of the unit.

### **Keep the unit dry**

Avoid exposing the unit to excess water or rain. While the spectrum is not particularly sensitive to humidity or water, exposing the unit's internal circuitry to water may result in fire and/or electric shock.

### **Do not operate a malfunctioning unit**

Should the unit emit smoke, or unusual odors, remove the power source from the unit immediately. Discontinue further use and contact eMotimo support.

### **Avoid extreme temperature changes**

Electronic devices may be damaged by sudden and extreme changes in temperature. Just like your camera, the unit should not be used immediately after moving it from a very cold temperature, to a warm environment. Allow at least 1.5 hours of slow warming in a sealed bag or case, before using the spectrum st4 after removing it from the cold.

### **Keep out of reach of children**

This unit contains small parts which may cause choking.

### **Use only eMotimo approved accessories**

While eMotimo encourages easily enable connecting to many accessories, please check with eMotimo before hooking up any accessory not sourced from eMotimo. Improper or unsupported accessories can damage the spectrum st4 or cause damage that is not covered under warranty.

# What's Included in basic bundles

(In a basic spectrum purchase, before accessories)

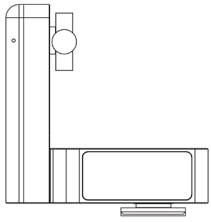

spectrum ST4



Controller

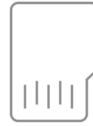

Micro SD card

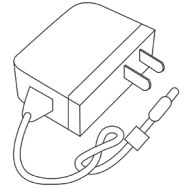

12V AC adapter

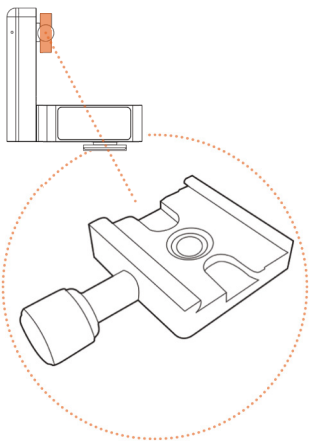

Arca clamp ships mounted to spectrum tilt

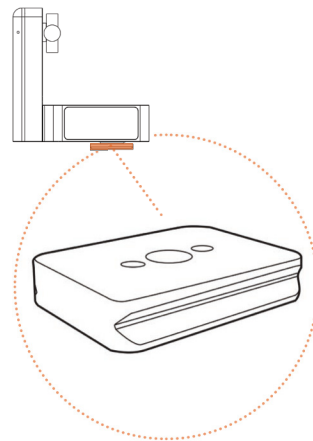

Arca plate mounted to spectrum pan base



Micro USB to USB remote charging cable

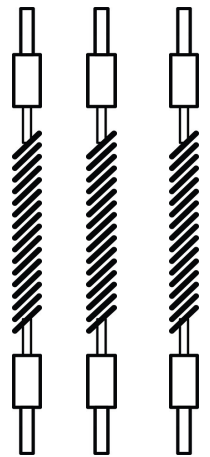

Pro Canon, Nikon, & Sony camera cables

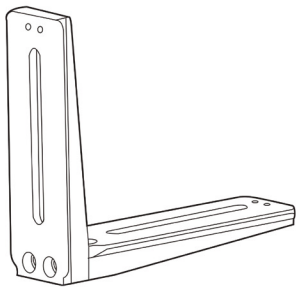

L-plate to mount camera to spectrum

**Portable battery not included**



# spectrum ST4 Hardware Map

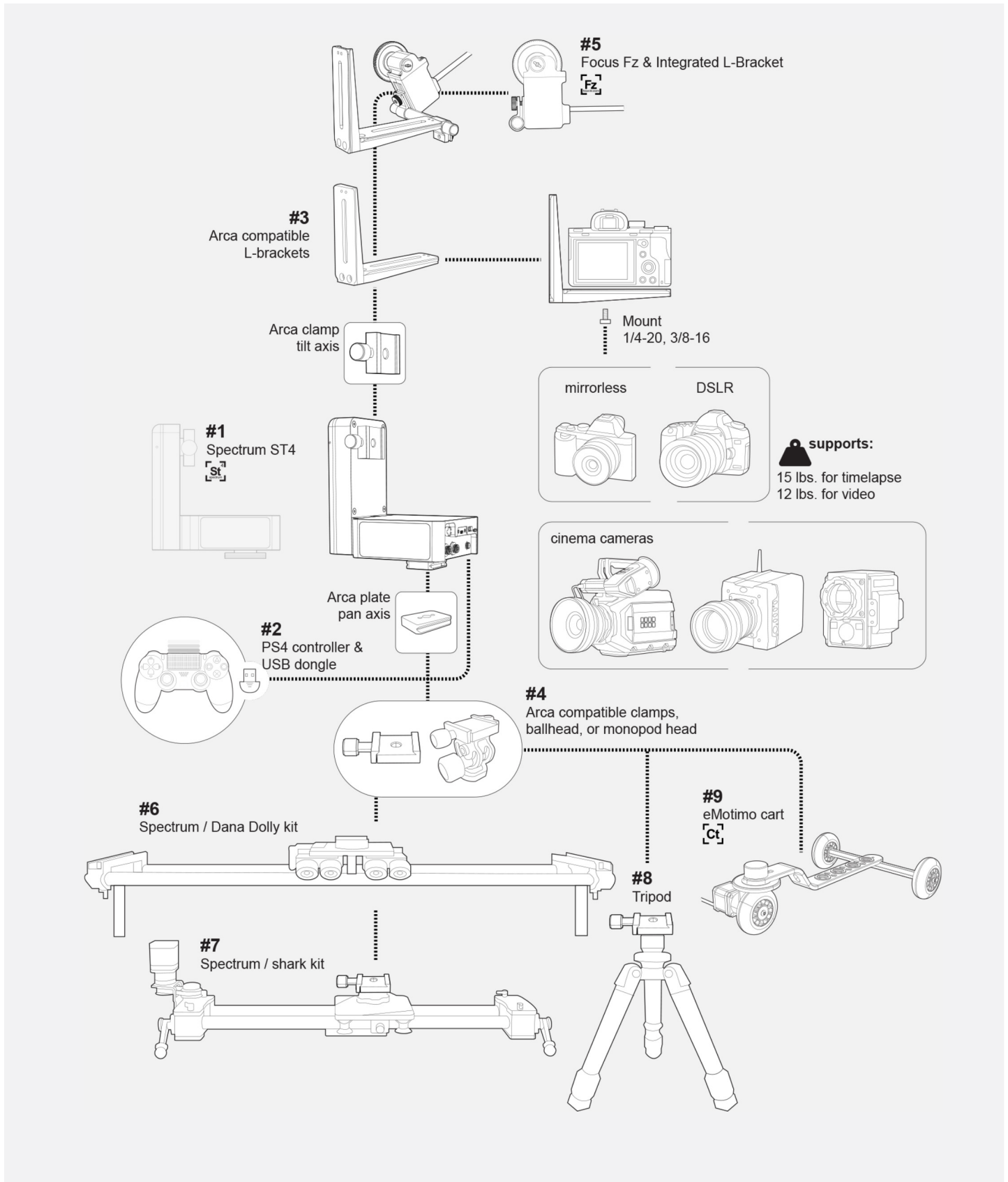

# spectrum ST4 Electronics Map

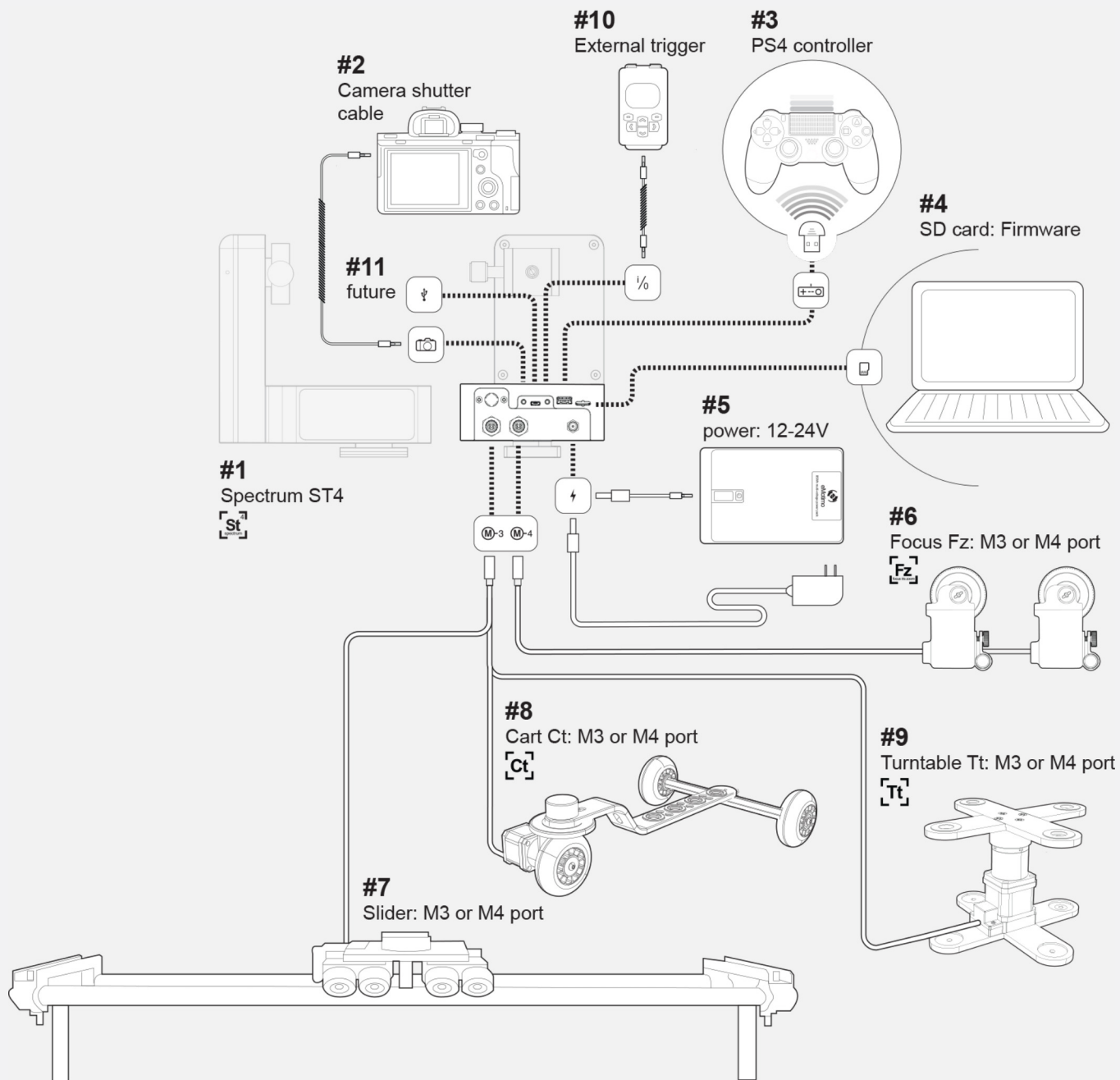

# Hardware Setup

**Step #1** Mount spectrum pan axis arca plate to arca clamp on tripod or slider.

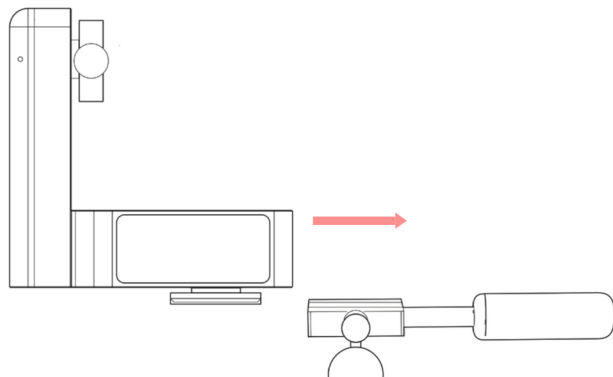

**Step #2** Mount camera to arca compatible L-plate.

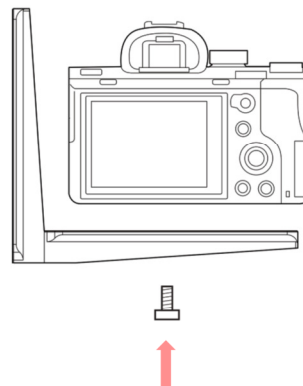

**Step #3** Mount camera and L-plate to tilt clamp.

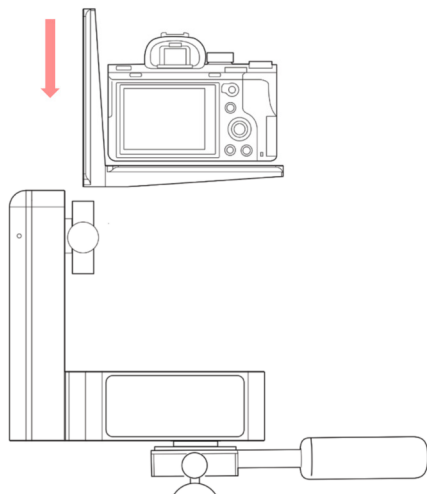

**Step #4** Optionally plug in camera triggering cables to camera port / camera.

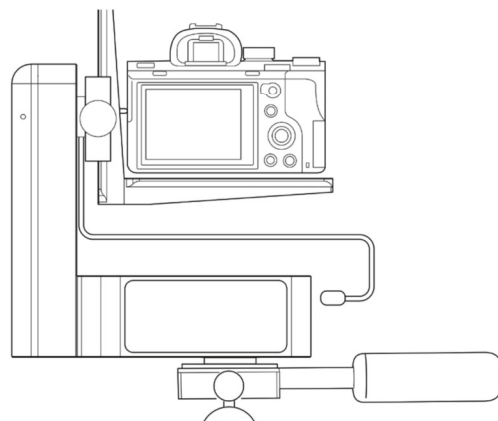

**Step #5** Plug in 12-24 volt power and immediately press and release the center PS button. Remote shows blue LED when connected.

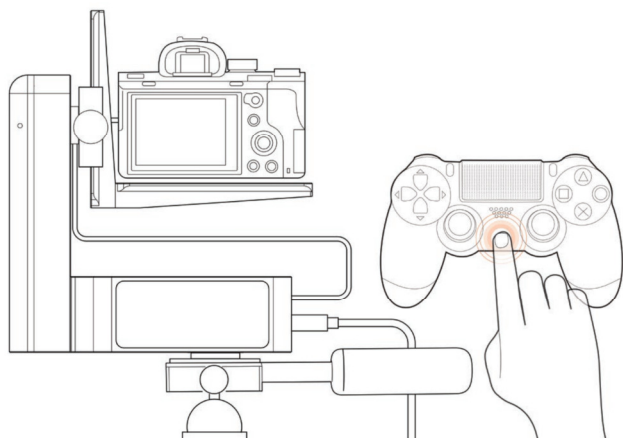

**Step #6** Shoot something amazing.

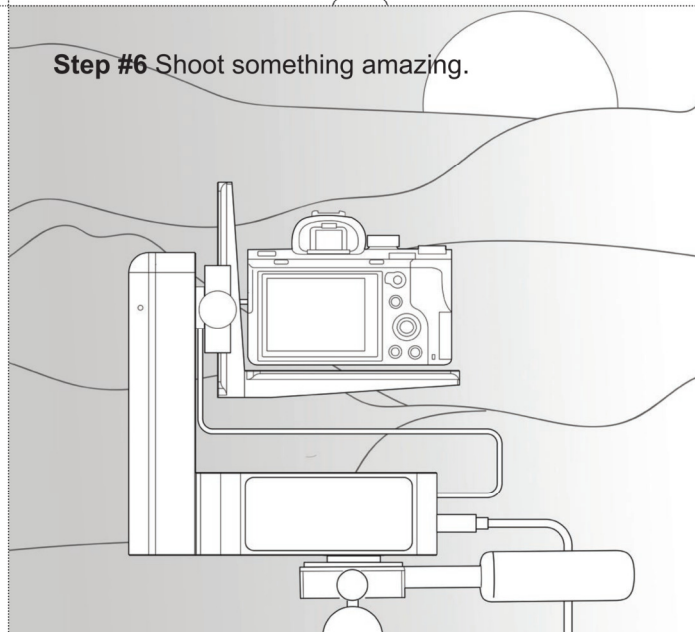

# Connections / Ports

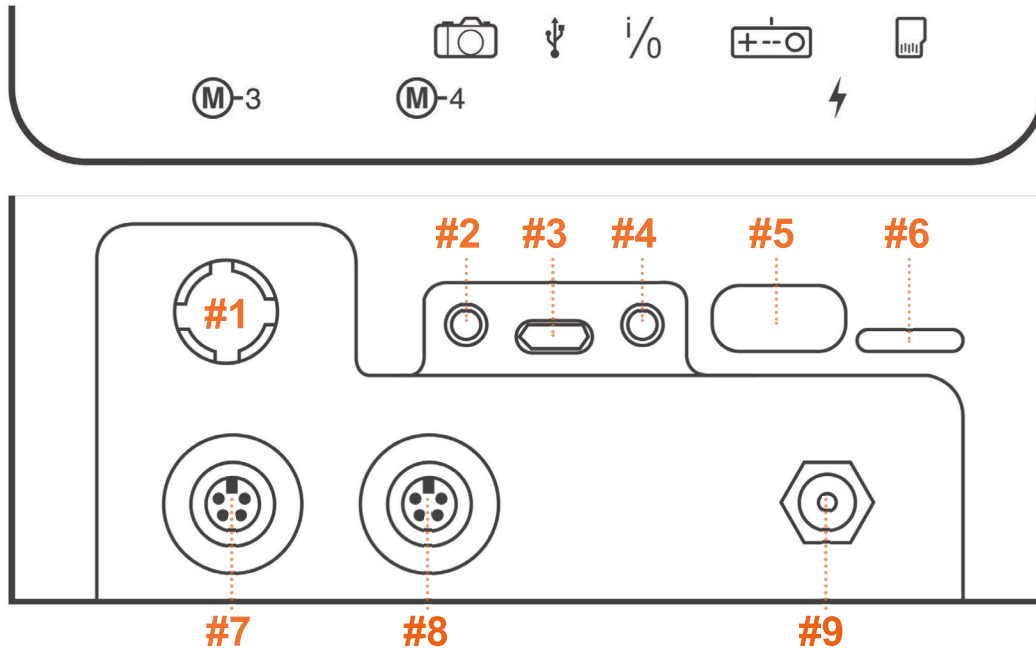

- 1. 8 way Navigation Stick (NavStick):** on spectrum control for navigation, selection and setting up programmed key-frame shots without a remote. See how to program a shot using only this controller - <https://vimeo.com/emotimo/spectrum-instructional-videos/video/189070569>
- 2. Camera shutter port:** Triggering your DSLR is accomplished by hooking up a camera specific shutter cable from the st4's camera port to your camera's shutter release port. During a timelapse sequence the st4 sends a focus signal and shutter signal to your camera at the same time for the duration of the Static Time setting. *Hint - Take Test Shots: The PS4 Controllers' right trigger (R2) will focus and fire the camera on most screens. A half press is focus, and a full press is shutter/ focus to trigger your camera to shoot.*
- 3. USB port:** Future functionality - Powering the spectrum for motor moves from any USB port is not supported.
- 4. i/o port:** The spectrum's i/o port is used for serial communication to external devices.
- 5. Remote control port:** This full-sized USB port is dedicated to hold the PS4 Controller's wireless dongle. If you remove the dongle for travel, keep it safe. You can't connect the remote without it!
- 6. uSD card slot:** The spectrum st4 ships with a uSD card. This card and port are used for firmware upgrades and future support of saved moves and settings.
- 7. M3 (motor 3) port:** The 3rd powered stepper port typically used for slider, but can be used for any approved stepper accessory. This port is controlled by the PS4's Left Joystick (**left/right**)
- 8. M4 (motor 4) port:** The 4th powered stepper port typically used for Fz, but can be used for any approved stepper accessory. This port is controlled by the PS4's triggers (**L2/R2**). **Did you know?** – Did you know the "4" in "st4" is for 4 axis control. The spectrum st4 is the first 4 axis powered controller of its type. We think having more axis give you more options to play increasing the palate of possibilities. Go tell better stories.
- 9. DC power in:** See [Powering your spectrum st4](#) below for details

# Powering spectrum ST4

Powering your spectrum ST4 is easy. You can use many off the shelf AC adapters and batteries. A 12V or 24V US AC adapter is included with most orders by default. The spectrum ST4 must be powered within the following specifications:

- Voltage – 10-24VDC.
- Current - Minimum 2Amps. 3.5A preferred.
- Connector for power port: 2.1mm x 5.5mm circular barrel connector – **center positive**.

**Warning** Powering the spectrum for motor moves from any USB port is not supported.

## V-Mount upgrade option

With the V-Mount upgrade, your spectrum ST4 will power on anytime you engage the battery. We are offering this upgrade with an IDX plate model P-V2. It includes a DTAP power port that allows you to power your camera from a single battery too!



# Controller

## PS4 Dualshock Wireless Remote

Your spectrum ST4 ships with an off the shelf PS4 Dualshock wireless remote for primary control. The analogue sticks have a great feel to them, the buttons are reactive and numerous, the sensors like gyros and touch-pads allow us creative options for control in the future and the rumble and light feedback allow for intuitive two-way communication.

When you are programming a shot, and driving a camera for live work, the only place you should be looking is the monitor. With a little practice, this controller allows you to intuitively move your spectrum without ever looking at your hands. Try to do that with an app!

We think the selection of this controller is key for capturing more organic shots, faster and more intuitively. See <https://vimeopro.com/emotimo/spectrum-instructional-videos/video/189012765> for video on how to pair and use your controller

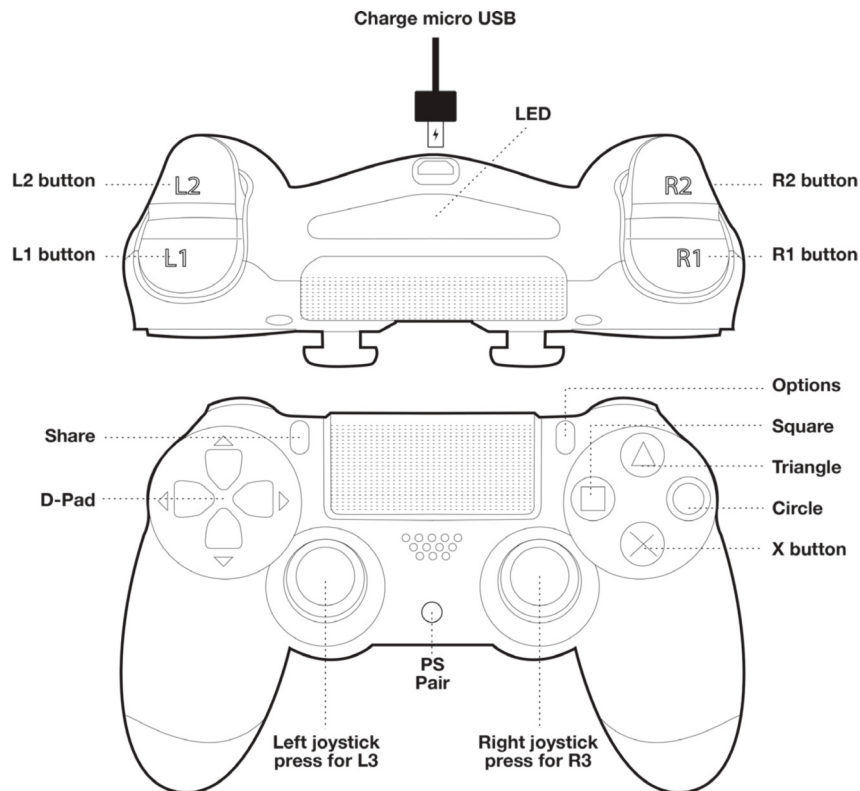

**D-Pad:** Navigate interface

**Left joystick:** Controls live motion

**Right joystick:** Controls live motion

**R2 and L2 Trigger:** Analogue Focus control

**X button:** Select/advance (hold for cancel shot while shooting)

**Circle, Triangle, L3, and R3:** GoTo Frames

**R1 and L1:** Set soft stops for Focus Fz (Motor port 4)

**Options:** Clear soft stops for Focus Fz (Motor port 4)

**PS button:** Press to pair. Hold button to disconnect.

# Remote LED Flash Indications



**Standard Condition:** Solid Blue



**Pairing Process:** Blue Flash



**ERROR: Fast Red Flash:** Error conditions over-voltage or under-voltage. Check power source.

**ERROR: Slow Red Flash:** Error conditions remote battery is low. Charge remote.



**Bloop Light:** On programmed video modes: Live Rec and Play, and Programmed Moves a visual preamble on PS Remote LED flashes Red, Yellow, Green, Go in a 1 second preamble. Also shows same condition afterwards.

**Hint Bloop Light:** *This is a pro tool for those who need “bloop lights” to line up multi-pass VFX shots.*

# Remote Information

## Quick Reconnection

Quick connection should be used unless your remote is new.

1. Power on the spectrum, wait until main menu shows on the screen.
2. Immediately Press and release the PS button (middle) of remote. The PS4 remote's LED will flash white in a slow even blinks while it is trying to connect. When the remote connects, the LED will show solid blue and is ready for use.
3. If the remote does not connect and stops flashing, press the PS button to retry the connection.
4. If the remote doesn't connect by indicating a solid BLUE on the second try, unplug the spectrum st4 from power, wait for the remote's LED to turn off and start the remote pairing procedure outlined above.

## Remote Charging

Make sure your remote is fully charged before you head out into the field.

1. Plug in a micro USB cable (not included, but typical of many phones / cameras) to the PS4 and then USB end to a computer.
2. Look for an orange glow on the back of the PS4 while it is charging. Once this turns off it is fully charged.

**Watch out!** Many field packs with USB ports will not charge the PS4. Use the orange glow as an indicator that the charging process is working.

## Disconnecting the remote while the rig is running

To save the remote's batteries once a program is running, you may disconnect the remote by pressing and holding the PS button for 1 second. or simply walk out of range and it will disconnect.

## Reconnecting the remote while the rig is running (in progress)

To reconnect, hit the PS button one and release. The remote will flash white slowly while trying to reconnect. If this process doesn't reconnect a power cycle of the unit may be required.

**Hint - NavStick**– even if reconnection is having troubles or your remote is out of batteries, you can still use the **NavStick** on the side of the spectrum to start or reverse a programmed move after a shot is complete.

## Resetting a remote

On rare occasions, a remote's battery gets really low or sits for a long period of time, it might not charge (indicated by orange glow). If it isn't charging or connecting, reset it. You can do this by using a thin tool to press the reset button on the bottom of the remote.

# Screen Map

## Live Motion / Programmed Shots

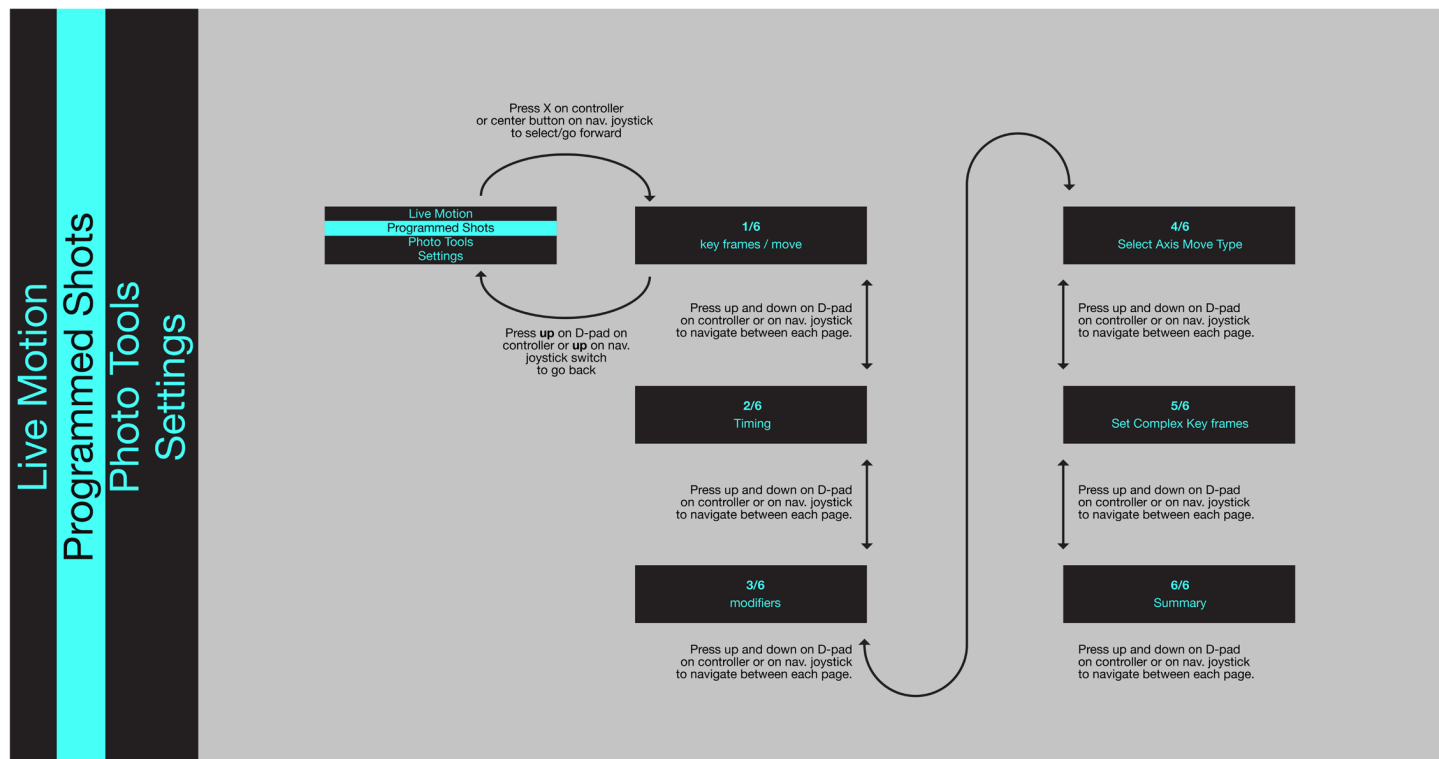
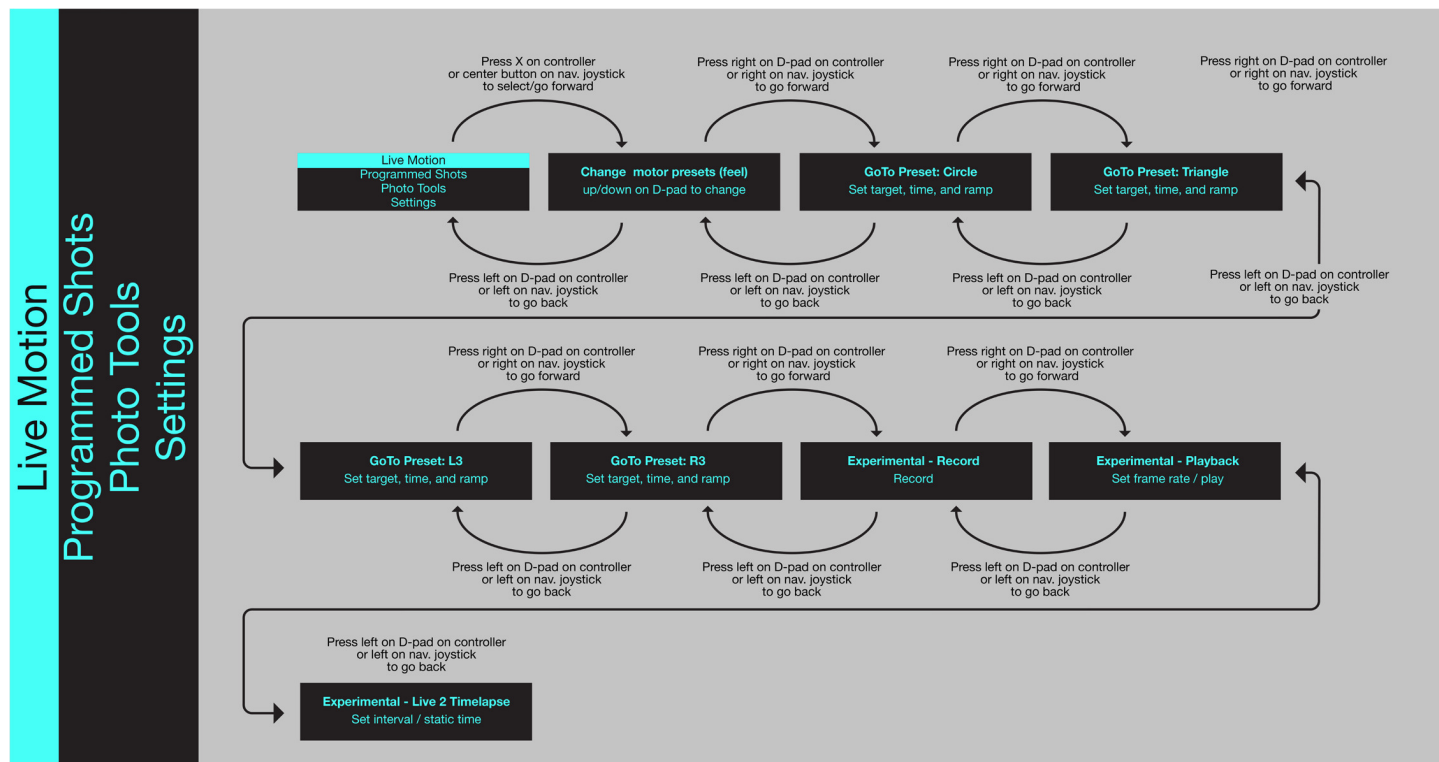

# Photo Tools / Settings

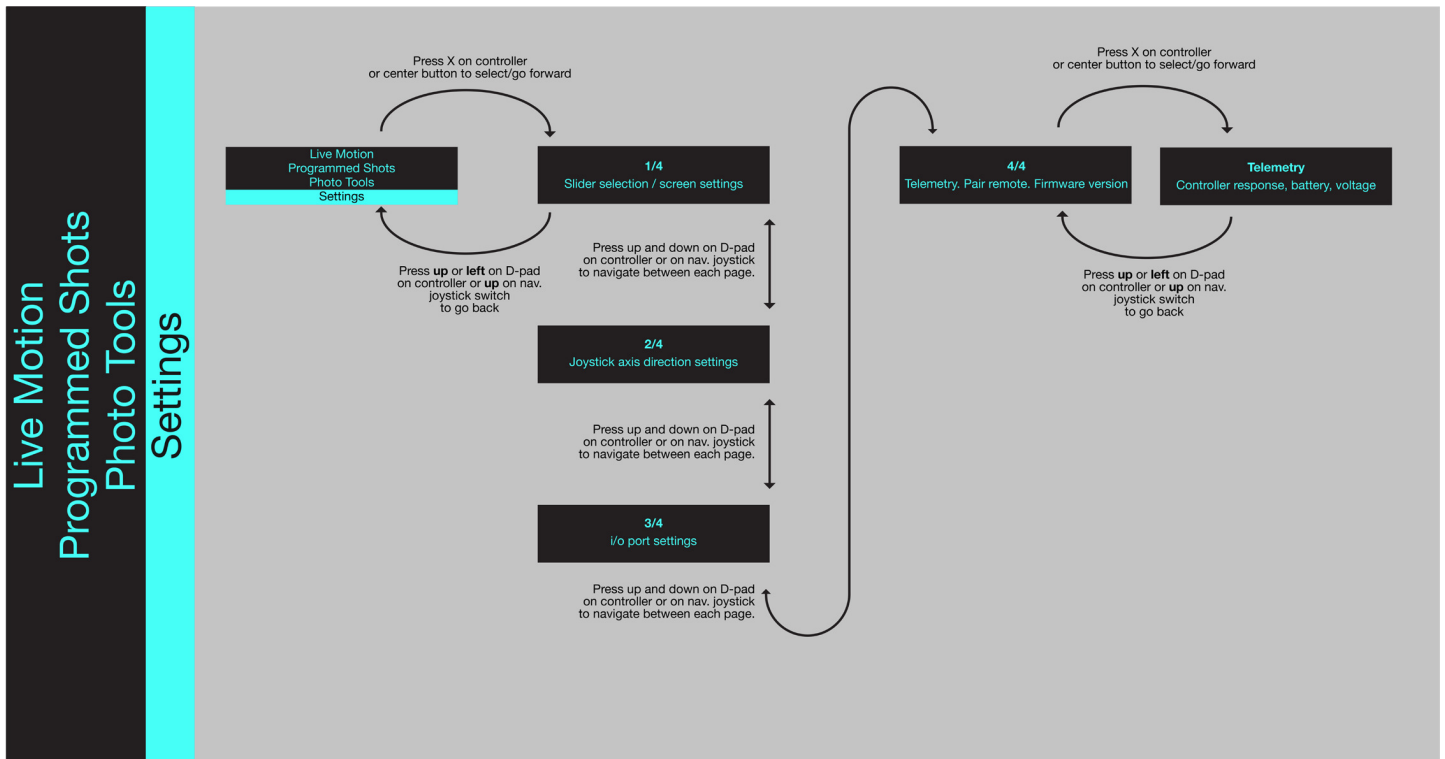
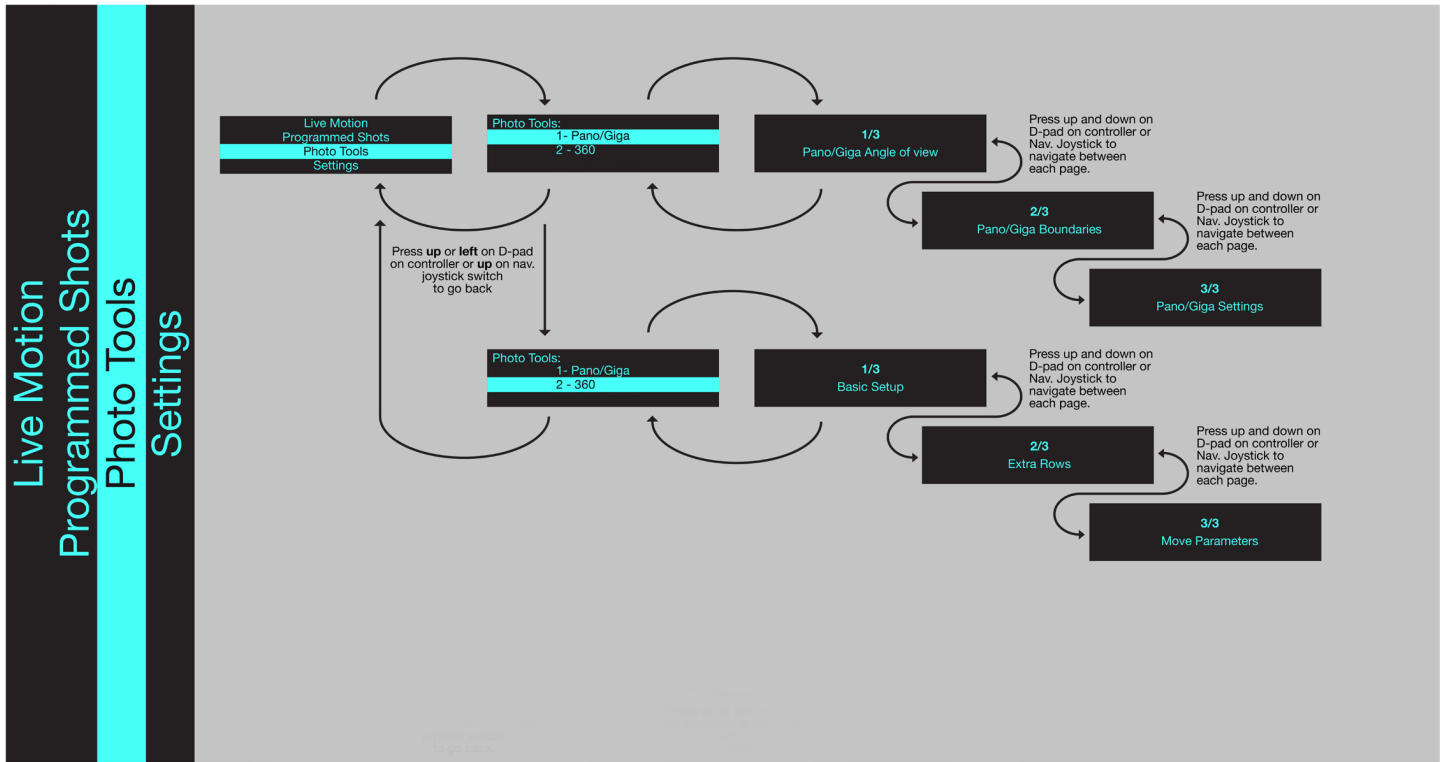

# Live Motion - Motor Preset (Feel)

Before moving motors, visit settings menu and select your slider:

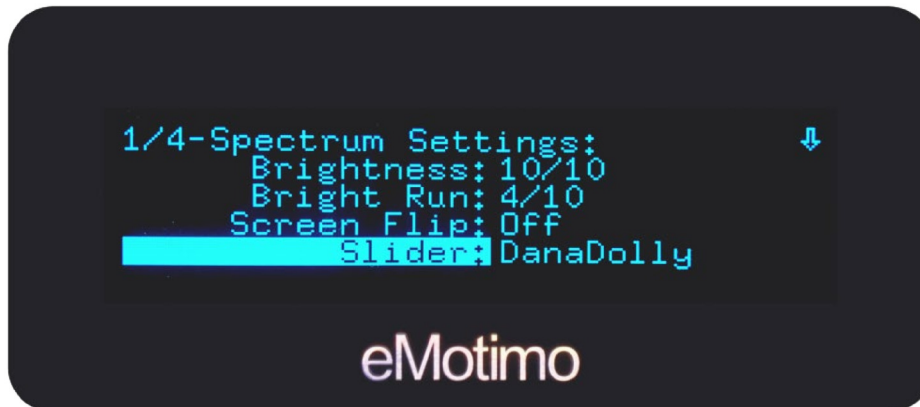

*\*If you're using Dynamic Perceptions, Rhino, or Kessler slider, please select iFootage slider.*

## The spectrum st4 is all about the feel.

Unlike our previous products and most other motion control on the market, the spectrum has outstanding live control through the remote. Because of this, we can live drive the head around for single pass with fewer jitters or unwanted movements that can show up with manual control. As you start to record moves, it becomes very important to tune your head for live control before you press the record button.

Power on the unit and select the first menu setting (Live Motion). Now you are on a motor presets page that allows you to drive the head around and experiment with some predefined motor move profiles. **Important Note –motor preset selection will restore after a power cycle.**

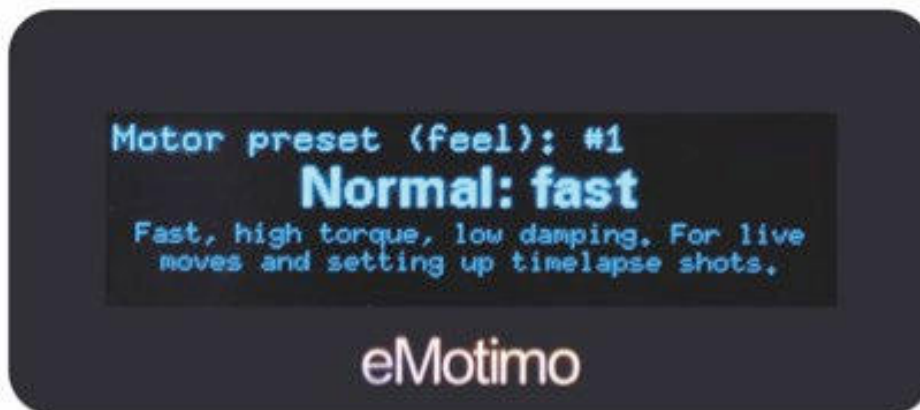

On this page, use the **Up/Down DPad** or **NavStick** to select a motor move profile. The names and general parameters for relative speeds and accelerations are shown, listed from 1-9. There are some motor profiles that are slow, some that are fast, some that are nearly silent, and some are super damped. Some are specifically meant for angled slider shots where power to lift a load is required. Play around and find what works for you with your camera/lens style combination.

## Dana Dolly Motor Presets

Preset:	Name:	Detail:	Best for:
#1	DD Normal: Quiet/Fast	Quiet, medium damping mode.	For fast live and programmed moves.
#2	DD Medium: Quiet/Medium	Near silent, medium damping mode.	For medium live and programmed moves.
#3	DD Medium: Quiet/Slow	Near silent, high damping mode.	For slow live and programmed moves.
#4	DD Medium: Timelapse	Fast setup, efficient power handling mode.	Long runs with SMS timelapse.
#5	DD Turbo	Fast, non-quiet mode	For VFX. Only use with 24V AC power.

## iFootage Motor Presets

Preset:	Name:	Detail:	Best for:
#1	Normal: Fast	Default high torque, high speed mode.	General time lapse and live moves
#2	Normal: fast/damped	Default high torque, high speed mode with damping.	Live video with smooth and damped starts and stops.
#3	Normal: slow/damped	Default high torque, slow speed mode with damping.	Fine control over small movements. Live video for smooth, slow, powerful shots.
#4	Quiet: fast	Quiet motors with high speed and low torque.	Lightweight cameras shooting video. Quiet modes are great for recording audio.
#5	Quiet: normal	Quiet motors with slow speed and normal torque and damping.	All cameras shooting video and recording audio that don't require high speed moves.
#6	Quiet: damped	Quiet motors with our slowest speed and high torque and high damping.	Heavier cameras shooting video with smooth, slow motion. Great for shooting macro and telephoto.
#7	Turbo	Fastest, lowest torque mode.	High speed shots. High motion/high frame video.
#8	Angled TL	Fast moves with high torque M3 motor port.	Time lapse and video moves on a slider that require torque. For example, moving up a slight angle on the slider M3 axis.
#9	Steep TL	Fast moves with the most torque for the M3 axis	Time lapse moves on a slider that require the most torque. For example, moving vertically on the slider M3 axis.
#10	Live Focus Normal	Normal slow/damped with slower focus motor.	Smooth live video moves with fine focus control where sound control isn't necessary.
#11	Live Focus Quiet	Normal slow/damped with slower focus motor in quiet modes	Smooth live video moves with fine focus control with quiet pan/tilt/focus motor.

# Live Motion - Motor Preset (Feel)

Watch video: <http://emotimo.com/project/st4202/>

**GoTo** positions are targets or presets for a position of the motors. When shooting live you can use these GoTo points to accurately hit the target that you preset in the time you set, with the cinematic feel that you set. These points are very useful for long lenses where hitting your targets is difficult manually, or for perfectly framing a shot. Using multiple GoTo positions are useful for setting up quick video moves and traversing between these points live.

There are three GoTo presets you can program. To set, scroll over to the GoTo positions pages. Do this from the main menu by selecting the top menu (Live Motion) and then pressing the right DPad button or right on the **NavStick** until you see the GoTo frames headers. The first heading you will see is the GoTo Presets: Circle. By moving right on the DPad or right on the **NavStick** you will find the GoTo Presets: Triangle, L3, and R3.

Programming a GoTo Frame:

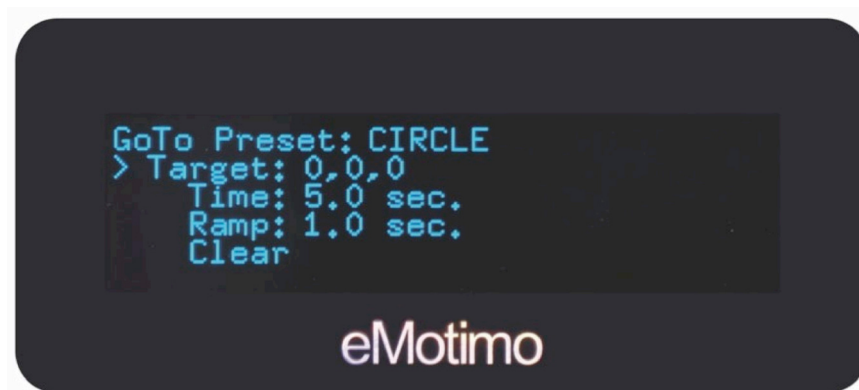

- 1.Target:** Set your target parameter by moving all 4-axis to a position you want to lock in as a preset. Press X to lock in this position.
- 2.Time:** Once Time is highlighted, scroll up and down to program the amount of time/duration you want your move to take to arrive at your target position.  
**Hint** – The further away your position is from the target, the faster the spectrum will have to move. This is an easy way to play with a target position. Set a start point and the head in many directions and distances to see how the move looks and feels. Each time, the spectrum will hit your target.
- 3.Ramp:** Program the acceleration and deceleration in seconds at the start and end of your move to the target position. Ramp is included in the overall duration of the shot. In other words, ramp time is not added to the overall time of the shot.
- 4.Clear:** Press X twice to clear your target position.

Once a preset is programmed, you can move the head around freely. When you hit the preset button, the head will drive all 4-axis to the preset (GoTo target position) with the qualities you programmed in to that preset. Any screen change will stop the move.

# Live Motion - Experimental

## Record / Playback / Live 2 Time lapse screens

**Record, Playback, and Live 2 Time lapse** screens allow you to record a move live and have the spectrum play / repeat that move back to you over again. You can also program it to play it back to you at different frame rates (speeds). You can also program it to play your move back in the form of a time lapse (Live 2 Time lapse). This function enables you to program incredibly organic time lapse moves.

To start, select the top menu (Live Motion) and then pressing the right **DPad** button or right on the **NavStick** until you see the **Experimental – Record** screen.

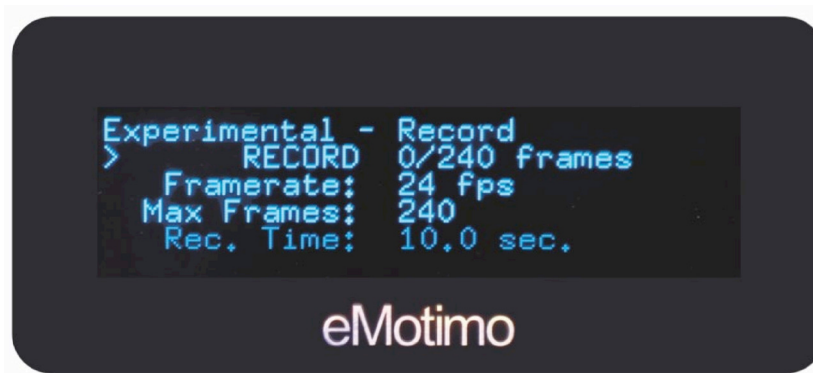

1. Get the head “feeling” the way you want for a shot. See [Live Motion – Motor Presets \(feel\) section](#)
2. Highlight and choose the **Frame-rate** for the spectrum’s record rate. Currently 24, 30, 60fps are selectable. This setting defined how many times a second the spectrum st4 records its live position. To start, we recommend that you select the frame rate to match what your final video’s frame rate will be. *Hint:* The Record Time will be calculated and shown below based on the Frame rate and Max Frames.
3. Highlight and choose the **Max Frames** for the total frames that spectrum will record. -The range is from 100 to 2880 frames in increments of 1. *Hint:* The Record Time will be calculated and shown below based on the Frame rate and Max Frames.
4. When ready, move the cursor to the first row, **RECORD**.
5. Press X immediately start recording. RECORD will highlight.
6. Move the head any way you want with live controls on all axis.
7. When the Record function is finished, your move is saved in memory.
8. You may choose to
  - a. Record – hit RECORD and the move will be overwritten
  - b. Change a Setting and rerecord
  - c. Move on to
9. Once you are satisfied, press right on **DPad** or **NavStick** to move to the Experimental – Playback screen

# Live Motion - Experimental

## Experimental - Play Screen

1. Use the **DPad** up and down to select **PLAY**. Once pressed, the spectrum will return to start and begin playing your move back.
2. You can play your move back at a different frame rate. To do so, scroll down to Frame rate, select and scroll up and down to adjust. You will notice your Play Time changing as you adjust your frame rate. You may playback the same move as many times as you want for visual effects.
3. Press right on **DPad** or **NavStick** to move to the Experimental – Live 2 Time lapse screen.

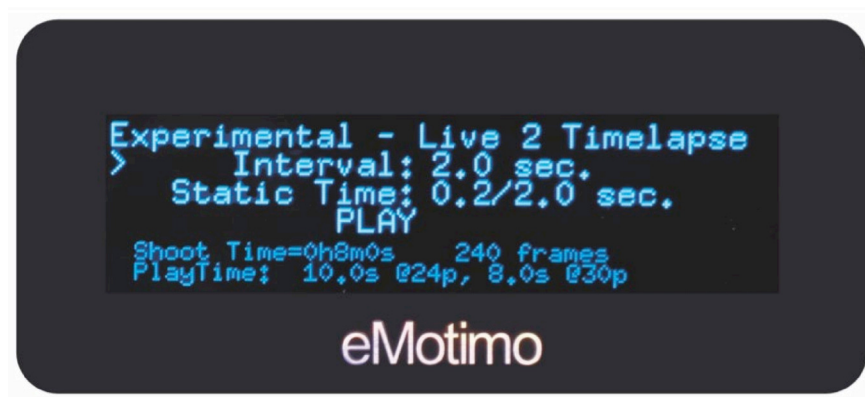

# Live Motion - Experimental

## Experimental - Live 2 Timelapse Screen

Once a move is recorded, the Live to Time lapse screen just enables you to play it back frame by frame with a set interval and static time like any other time lapse.

1. Use the **DPad** up and down to select **Interval**. The interval is the amount of time lapsing between each shot's start.
2. Use the **DPad** up and down to select static time. Your static time is the amount of time the spectrum remains stationary while your cameras shutter is open. As a rule of thumb, take your camera's exposure time and add 0.1 seconds onto it.
3. Connect a shutter cable to the spectrum and camera. Take a test shot
4. Use the **DPad** up and down to select Play. Your move will begin and your camera will start firing.

During a shot, you receive feedback like other time lapse shots, on frame, remaining time and status. Hitting X or the **NavStick** center button, will pause the time lapse. When paused, you can scrub the move by using the **DPad** or **NavStick** directions. The spectrum will move to the appropriate frame. Hitting X while paused, will resume the shot. Hitting Square will cancel the shot and return you to the Live 2 Time lapse screen (the move will not be erased)

### Known Issues / Behaviors for REC/Play;

- You cannot save these moves. No moves are saved after powering down.
- You cannot record less or more that the Max Frames.
- Playback engine not optimized yet. Changing frame-rates is encouraged for playback, but can result in footage that isn't a smooth as the original frame rate (working on it!)

### Hints for Live 2 Time lapse.

- Only shoot the frames you want for your final shot. If you only want 10 second of footage, only shoot 10 times your frame rate (240 for 24fps, 300 for 30fps, 600 for 60fps).
- Playback the footage to ensure you got what you want at the frame rate of your final composition (this is essentially a review of what a time lapse will look like)

# Programmed moves

## Programmed moves are how most motion control gear works.

You set up key-frames and parameters and then let the head define the trajectory between those key-frames. Programmed shots are easy to set up and run

*Did you know that . . . Back in 2010, the \$510 eMotimo PT was the only key-frame programmable motion control robot less than \$10K? It enabled setting up shots in the field without a computer in just a couple of minutes!*

### Setup is 2-point SMS or 2-Point Video or Multi-Key-framing Option:

Use the up and down D-Pad on the remote or the Spectrum **NavStick** to work your way through the 6 setup screens. Center button on the spectrum **NavStick** is the same as X on the remote.

You need to select (highlight) a value to change it. You do this by using the Center button on the spectrum **NavStick**, or the X on the remote.

During the setup process, when choosing values, the **DPad's** up/down buttons on the remote move values the smallest amount. Using the **DPad's** left right increments larger values. Or you can hold Up and Down (both **NavStick** and remote) to accelerate through many values.

Parameters defined:



1. **Type:**
  - a. **Timelapse:** This is a 2-9-point shoot-move-shoot timelapse shot. If you are shooting timelapse and want the spectrum to trigger your camera to shoot, select this shot type.
  - b. **Video:** This stands for a 2-9-point video shot. If you are shooting a continuous video move, select this shot type.
2. **Start Point:** This is where your move will start. Once highlighted, control and move all 4-axis at the same time using the included PS4 controller or control 2-axis at a time using the onboard **NavStick**. Move to the point where you would like your move to start and press X on the PS4

controller to continue. If using the **NavStick**, press center button once to advance to control your 3rd and 4th axis for programming. Once satisfied, press center button on your **NavStick** a second time to continue.

- 3. End Point** This is where your move will end. Once highlighted, control and move all 4-axis at the same time using the included PS4 controller or control 2-axis at a time using the onboard **NavStick**. Move to the point where you would like your move to end and press X on the PS4 controller to continue. If using the **NavStick**, press center button once to advance to control your 3rd and 4th axis for programming. Once satisfied, press center button on your **NavStick** a second time to continue.

**Hint** – if you are in a hurry, you can set up the End Point first and then the Start Point – this eliminates the time it takes for the rig to return to the start point. This is especially helpful if you are using a slow motor or slider. We used to call this Reverse Setup with previous products, but now, no special mode is needed.

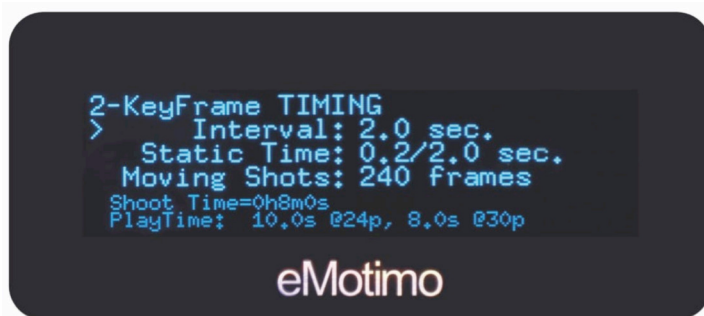

Timelapse



Video

- 4. Interval (SMS TL only):** Interval is your frame rate for time lapse or stop-frame animation. If you select a 2.0 second interval, the eMotimo spectrum will trigger your camera to start a shot every 2.0 seconds. If you want to speed time more, select a longer interval (good for shots taken over a long duration of time). If you want to speed time less, select a smaller interval (good for shots taken over a short duration of time). Interval time always needs to be set longer than the exposure time set on your camera. TIP: When shooting long exposures, set your interval to twice your camera's shutter speed.
- 5. Static Time (SMS TL only):** Static time is the amount of time the spectrum remains stationary and triggering your camera's shutter before it moves. For setting the correct static time, start with your camera's exposure time and add 0.1 or 0.2 seconds onto it. For example, if you are shooting a 2.0 second exposure, select a 2.2 second static time. If you are shooting daytime shots with 1/100th sec. exposure, use default of 0.2 second static time.
- 6. Moving shots (SMS TL only):** Select how many frames you want your move to take. Based on what you set your interval at and how many frames you want in your shot, the spectrum will calculate how long your shot will take to complete in real time at the bottom of the screen. **The max number of frames for timelapse is 2880.**
- 7. Duration (Video only):** In seconds, select how long you would like your move to take. The max duration for video moves is 12 hours.

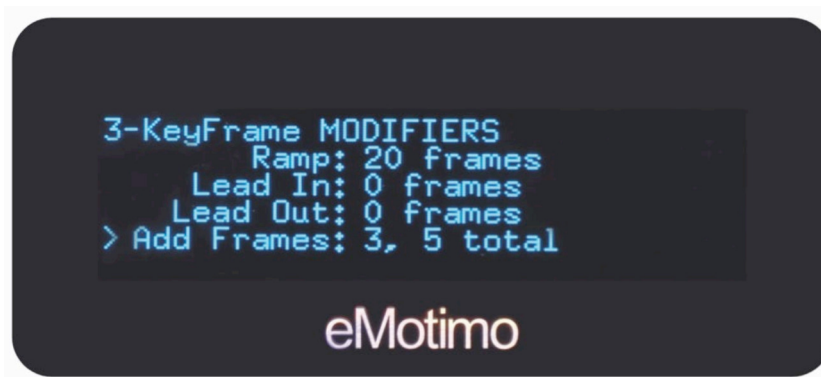

8. **Ramp (SMS TL and Video):** Ramp controls how smooth your starts and stops in your final footage are going to look. A low ramp means you are going to have an abrupt start and stop and a high ramp means you will have a very smooth start and stop. The number you select for your ramp in SMS TL is the number of frames in the final footage that show acceleration and deceleration. If you have 50 frames of ramp, you will have 50 frames at the beginning of your shot and 50 at the end of your shot where the footage shows acceleration and deceleration. If you are shooting in Video mode, your ramp will be represented as duration in seconds. This will be the time at the start and end of your shot that is ramped.
9. **Lead in and Lead out (SMS TL only):** Stationary lead-in/out is the number of stationary shots at the beginning and end of your programmed move. For example, if you set “24 in 48 out”, your program will fire your camera 24 shots at your set interval before any movement occurs. The ST4 will fire your camera 48 shots at the end of the shot, after movement has finished. If your final footage of your compiled shot is 24 FPS, then these “lead in/out” settings result in 1 second of stationary time at the start of your shot and 2 seconds of stationary time at the end of your shot.
10. **Add Frames (multi key-frames):** Watch video for more details here: <https://vimeo.com/185580976>. Here you can select how many additional key-frames you want to add to your two-point move. Add one for a 3-point shot, two for a 4-point shot, and so on.



11. **Select Axis Move Type:** Here, by axis, you select between a 2-point move (Start/End) and multi-key-frames (3-7 depending on what was selected for Add Frames on previous page) for each axis. If you select Pan, for example, and set it to start/end, then that axis will only move between the start point and end point. However, if you set Pan to multi-key-frame, the pan will transition from the start-point through all the middle key-frames and to the end-point smoothly. **Here you can also change Focus Fz motion from curved to linear.** As a result, your Fz will move directly to each key-frame without arcing the motion between points.

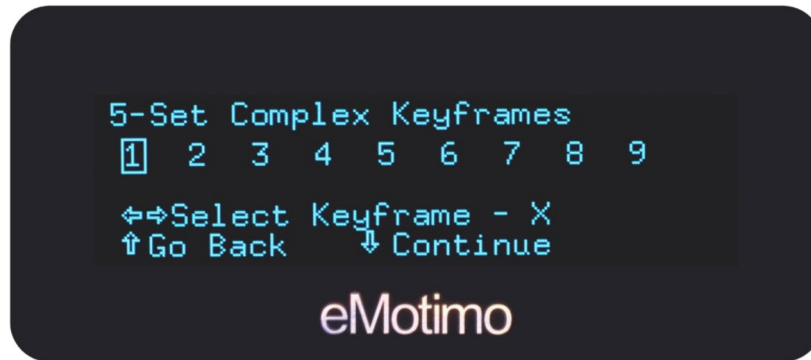

12. **Set Complex Key-frames:** By highlighting the key-frame number, all axis set as multi-key-frame (previous page) are live. If an axis is set as start/end, then it will not be live on all frames between the first and last frame. For example, on a 5 point move, it will not be live for frame 2,3, and 4.
13. **Shot Style (Video only):**
  - a. **Run Once:** In this style, your move will run once, meaning once your move completes, your move is over.
  - b. **Ping Pong:** In this style, your move will run continuously, meaning once your move reaches its end point it will return to its start point with the same ramp and duration and with continue this cycle over and over until prompted to stop

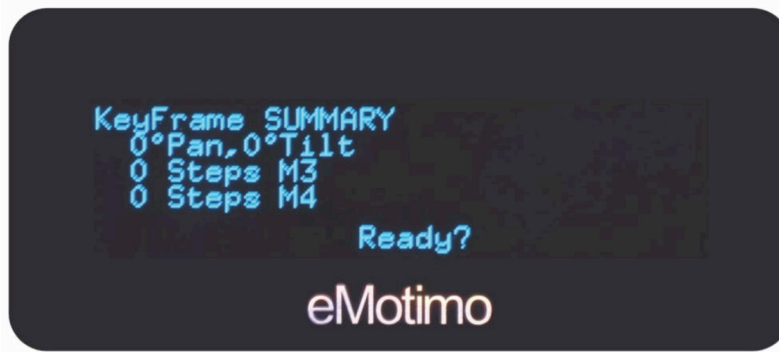

14. **Summary/ Review page:** If you are happy with your settings, then get to the last screen and hit the center button (or X on controller). It will go to start, and then tap it again to shoot.

**Hint – Backlash compensation:** When returning to start, spectrum will jog past the start point then return back the start point from the other direction. This is for backlash compensation. We always want our motors lined up on the same side of the motors backlash for every move.

**While Shooting,** pressing X on the remote or the center button on the spectrum will pause the move. While paused, using DPad’s up/down buttons you can scrub the move and go to a frame. As you scrub, you will notice the spectrum moving with you live to the frame you’re on. The spectrum will continue your move once you un-pause the shot by hitting the X button. You can also abort and return to the home screen by pressing Square once the shot is paused.

**After Shooting,** a menu to repeat, reverse, or reset will pop up. Select the option you want.

**Hint –** If you want to adjust timing or shot parameters, use the D-Pad to go back up into the setup process to change a value. You can even go back and adjust the start and end points. Start the shot back up by returning to the review screen.

# Using an external intervalometer

**Externally Triggering from the I/O port:** In special cases where you want to use external timing controlled by exposure ramping solution like the View, Ramper Pro, or DSLR dashboard here are some quick setup tips.

- a. Insert the i/o triggering cable to the side of the spectrum. This is the stereo port on the right under the i/o icon. Watch out, don't put this in the camera triggering port or it won't work.
- b. The other end of the trigger cable can be a manual external intervalometer, or a brammer solution like The View. If you are using the view, use their AUX2 port.
- c. On your ST4, set up a timelapse shot and start it.
- d. Pause the program by hitting the X button or the center of the onboard joystick. If you need to jog back to the start, use the left DPAD or joystick to scrub to the beginning of your shot.
- e. The I/O port is now "looking for a signal telling the spectrum the camera's shot is complete to allow it to move the next position. Once received, the spectrum will advance to its next position.

## Manually triggering a shot for stop motion from the PS4 Dualshock

- a. On your ST4, set up a timelapse shot and start it.
- b. Pause the program by hitting the X button or the center of the onboard joystick. If you need to jog back to the start, use the left DPAD or joystick to scrub to the beginning of your shot.
- c. By hitting the R1 button on the PS4 remote, the spectrum will send a shutter signal to your camera through the camera triggering port, and then advance to the next position and wait.
- d. Move Wallace or Grommit, or whatever other stop motion subject you are shooting.
- e. When ready, hit the R1 button again.
- f. Repeat.
- g. The I/O port is now "looking for a signal telling the spectrum the camera's shot is complete to allow it to move the next position. Once received, the spectrum will advance to its next position.

## Reasons to externally trigger

- Want to manually advance a shot (stop-motion).
- Want to use a ramping solution and need to time motion.
- Want to synchronize multiple motion control rigs.

**The i/o port is a triggering port AND a communications port for serial communication. We allow users to configure the port to use three ways:**

- Ext. Trigger, eMotimo API, or Dragonframe.
- Make sure have selected Ext.
- Trigger for the above modes.

# Photo Tools

## Pano/Giga

Photo Tools is extending your spectrum st4 to enable multi-row panorama or “gigapixel” photo capture. Unlike other modes in the spectrum, the end result of this mode after processing is a single

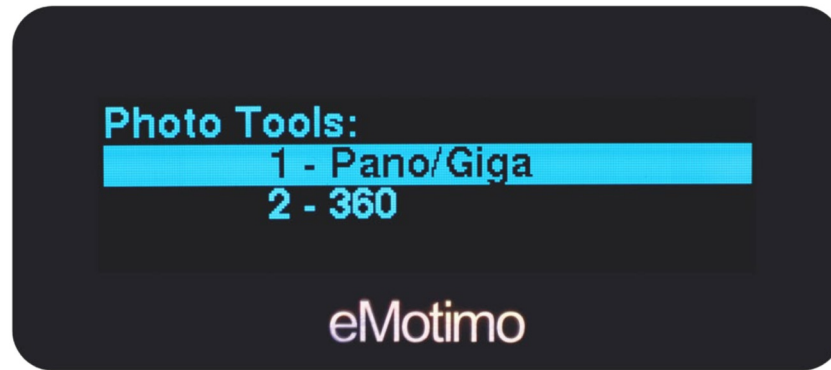

picture.

The process is pretty straightforward and can be summarized by the following steps:

1. **Pano/Giga Angle of view (AOV):** When shooting overlapping panorama images, we need to tell the spectrum what your camera can see. This term is called Angle of View. If you are shooting with a wide-angle fish eye, you might get an angle of view of 100 degrees or more horizontally. If you are shooting with a zoom lens on a crop-framed sensor, you might only get an angle of view of 2-3 degrees. Because of all the things that affect what your camera can see (sensor size, focal length of lens, % of viewfinder covers, camera manufacturer), it would be really hard to just enter a focal length and come close to accurately defining how much of the world you capture in a single frame.
  - a. **Viewfinder Corner 1:** Our solution is for you to define the Angle of View by looking through your camera’s lens to set a couple of points. Start by setting your Corner 1. To do this, highlight Viewfinder Corner 1 and move the camera so that we have something sharp that we can put at one corner of your viewfinder. The corner of a building, or a mountaintop in the distance works well. Press X to lock that corner in.
  - b. **Viewfinder Corner 2:** With this sharp point at one corner, highlight Viewfinder Corner 2 and move completely across the frame diagonally to put that sharp point in the opposite corner. Then press X to lock it in. By doing this you are telling the spectrum the pan and tilt Angle of View (AOV). As you are moving to the second point, the spectrum gives you feedback on how many angles you have moved for both Pan and Tilt as well as the calculated aspect ratio of the shot.

### TIPS and TRICKS:

- i. Use a sharp point far away from the camera like a house or mountaintop in the distance. If you use a fence post, 3 feet from you, it won’t be as accurate.
- ii. Turn on your Live View function. If you don’t have a 100% viewfinder, the corners will move slightly, making your angle of view less accurate.

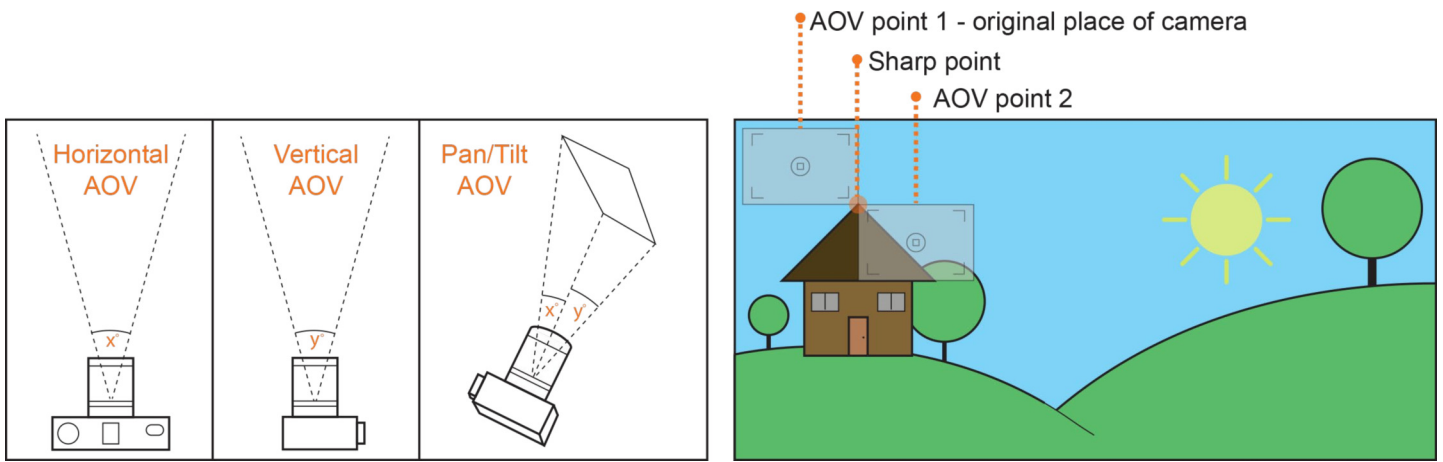

## 2. Pano/Giga Boundaries:

- a. **Min. Overlap:** Select the percent of overlap you hope to achieve with your photos in your panorama. Having your photos overlap will make stitching together these images in post more manageable. Please note that the percent of overlap you select (e.g. 25%) will be the minimum overlap percent between photos. Depending on how you frame your entire panorama, this overlap may be larger.

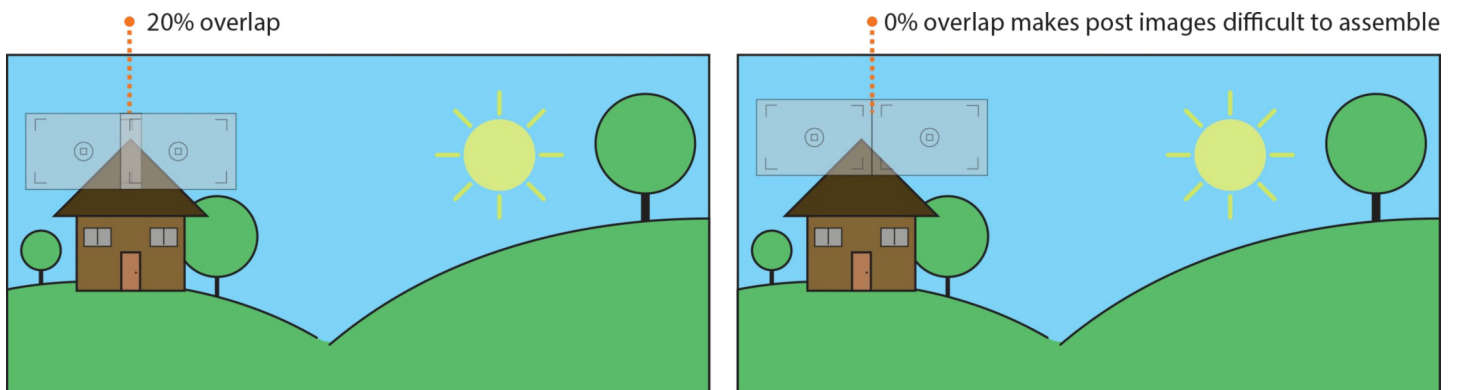

- b. **Boundary 1:** Use the remote to pan and tilt until you have framed the top left corner of your panorama. Once you are satisfied with the first frame, press X to continue.
- c. **Boundary 2:** Use the remote to pan and tilt until you have framed the bottom right corner of the panorama. By setting each corner of your panorama, you are defining the boundaries of your shot. Once you are satisfied with the last frame, press X to continue. Tip: the spectrum will give you live feedback on how many row, columns and total shots the required for the pano/giga as you program it.

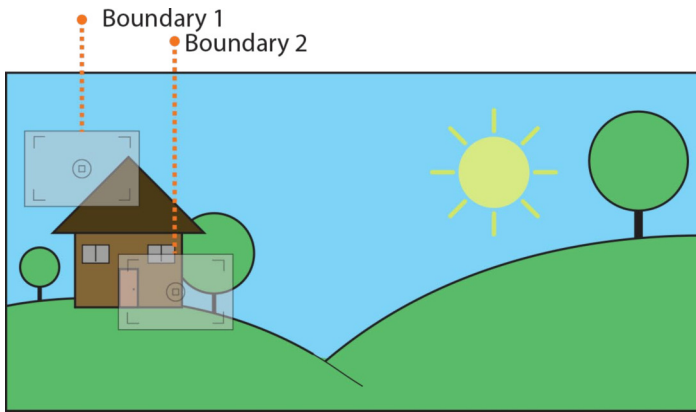

Once set, the spectrum will calculate how many photos, rows and columns your program will take upon completion

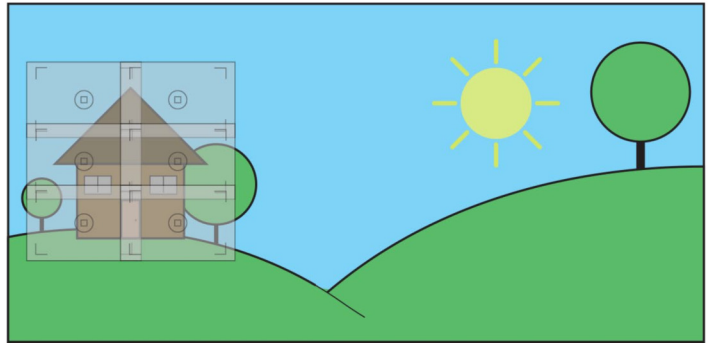

### 3. Pano/Giga Settings:

- a. **Cam. Exp. Time:** Enter your camera's exposure here. The spectrum will stay still for the entire length of your camera's exposure and move when complete.
- b. **Type:** The type is referring to how the spectrum will move through your boundaries. You can either:
  - i. **Zig Zag:** This type of movement will travel one direction along rows, then tilt to the next row and travel the opposite direction until complete. This method is the fastest.
  - ii. **Typewriter:** This type of movement will travel in rows in one direction, then advance to the next row by tilting while returning to the original pan position. This method, allows for easier stitching with certain types of pano programs.
- c. **Speed**
  - i. Slow- Slowest transition speeds between shots – good for long, heavy telephoto > 150 mm
  - ii. Normal: - Medium transition speeds between shots – try for 50->150mm
  - iii. Fast: F transition speeds between shots – try for wide angle up to 50mm
  - iv. Ludicrous – Great for high speed shots with fast exposures – play with it!
- d. **Run – Hit the X button to pause the shot.**  
The spectrum st4 will start at Boundary 2 and work its way through the shot back to Boundary 1.

## 360 VR / Spherical Pano

Although, setting up a 360 VR shot is made simple with spectrum, please note, we are a compact head where portrait shooting for zenith on node won't work for many camera body combinations. If Spherical pano shooting and the requirements are your main goal, we can get part of the way there, but will have limitations with physical geometry compared to taller solutions where a portrait shot can tuck in better for larger camera bodies.

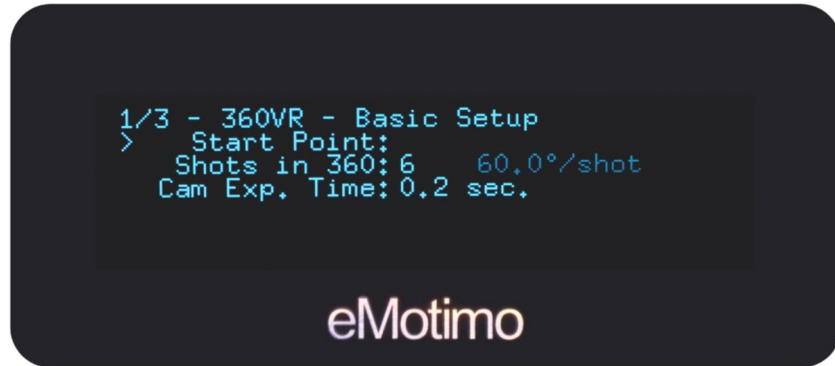

### 1. Basic Setup:

- a. **Start point:** Press X to select your start point. Move spectrum while looking through your cameras viewfinder to choose the frame in which you would like to start your 360 VR shot. Press X to lock it in.
- b. **Shots in 360:** Choose the number of frames you would like spectrum to trigger your camera to take per 360 degree rotation.
- c. **Cam Exp. Time:** How long is your cameras exposure? Set it here. Spectrum will then know how long to stay still while your shutter is open, before moving the next position.

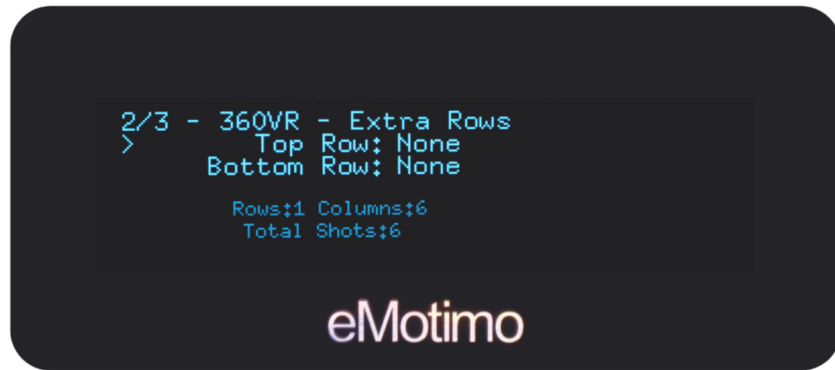

2. **Extra Rows:** The default is one row of shots. If you are interested in adding rows, you can do so here.

- a. **Top Row:** If you want to shoot a row above where your starting point is, then press X to highlight the Top Row prompt. Once selected, scroll up using the d-pad, to select the number of degrees of upward angle you would like your top row to be angled at above the starting point.
- b. **Bottom Row:** If you want to shoot a row below where your starting point is, then press X to highlight the Bottom Row prompt. Once selected, scroll up using the d-pad, to select the number of degrees of downward angle you would like your bottom row to be angled at below the starting point.

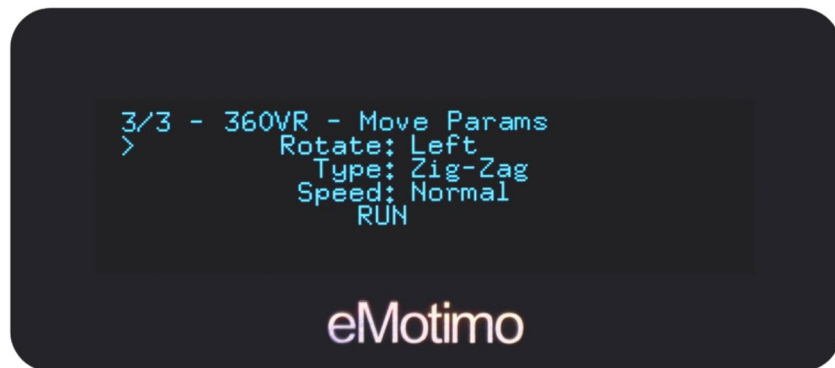

3. **Move Params:**

- a. **Rotate:** Press X to select the direction you would like spectrum to rotate in while triggering your camera.
- b. **Type:** Press X to select the style of movement you would like spectrum to perform between rows. Refer to page 30 for details.
- c. **Speed:** Press X to select the speed in which spectrum will move between frames. With longer lenses, slower speed modes are recommended.
- d. **Run:** Make sure your camera cable is plugged into spectrums camera port and your camera shutter release port. Press X to run your move.

# Settings:

Settings and motor preset selection will retain after a power down.

## Settings Page 1/4

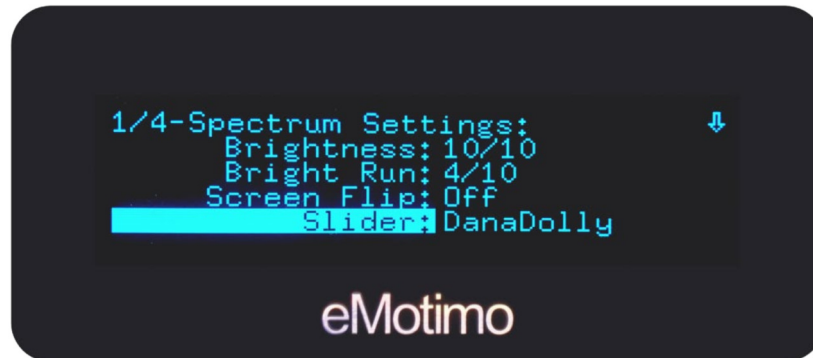

### Brightness:

Adjust your display brightness here by pressing X button on PS4 controller or center button on **NavStick** to select. This is the brightness of your display for normal operations (navigating menus, programming a move, etc.).

### Brightness Run:

Adjust the brightness of your display for the duration of a programmed move. This brightness setting only comes into play once you start your programmed move. Press X button on PS4 controller or center button on **NavStick** to select. Once selected move up and down to adjust. You can set this brightness to 0 and have your display turn off completely during a move to avoid any unwanted light.

### Screen Flip:

Are you under-slinging spectrum? Need to invert the screen to read it? Press X button on PS4 controller or center button on **NavStick** to select. Once selected move up and down to adjust. Press X to select.

### Slider:

What slider are you using? Select it here. This setting will change what motor profiles you can select under the Live Motion menu. If you are using a slider that is not listed out here, such as Dynamic Perception, Rhino, or Kessler, please select the iFootage slider. Please note, iFootage turbo mode will only work on Direct Drive motors on the iFootage slider. Press X button on PS4 controller or center button on **NavStick** to select. Once selected move up and down to adjust. Press X to select.

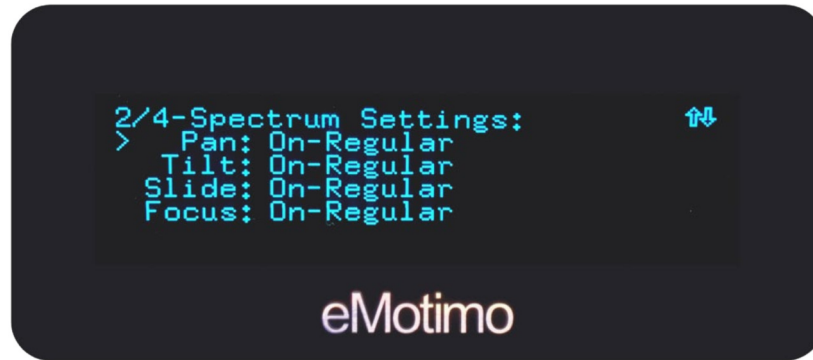

### Basic Axis settings:

Adjust the way your axes are controlled here. Press X button on PS4 controller or center button on **NavStick** to select. Once selected, move up and down to adjust and press X button on PS4 controller or center button on **NavStick** to deselect.

- a. **On-Regular:** This is the default regular setting
- b. **On-Reversed:** Invert the movement of an axis by selecting On-Reverse for that axis.
- c. **Hold:** Turn an axis off from movement, but continue to power it by selecting hold. This is helpful if an axis needs to support weight, but you don't want that axis to move at all.
- d. **Off:** Currently the same as hold. Future versions will completely depower the axis. Warning once you do this, that axis will no longer have power. As a result, this can cause your unit to slip and loose position.



**I/O Port:** The i/o port allows spectrum ST4 to take in communication from 3rd party devices. The options are:

- a. **Dragonframe computer software:** Dragonframe is great for programming complex key-frames and saving moves. For this integration you will need our USB to I/O port cable for spectrum ST4: <https://emotimo.com/products/usb-to-i-o-port-cable-for-spectrum-st4>. For more on this integration, please visit our support article here: <https://support.emotimo.com/hc/en-us/articles/360002057012-Experimental-Getting-Started-with-Dragonframe-4-1-and-spectrum-ST4-Real-Time-Interface>
- b. **eMotimo API:** We do have an API for spectrum If you're a developer interested in programming spectrum's movement through your software, please reach out to us directly at [sales@emotimo.com](mailto:sales@emotimo.com) for details.
- c. **Ext. Trig (refer to page 27):** If you are using spectrum with an external trigger (often times used for bulb ramping) select Ext. Trig. For details on setting up an Ext. Trig shot, please visit our Ext. Trig support article here: <https://support.emotimo.com/hc/en-us/articles/115002878923-External-Triggering-with-the-ST4>

### SMS Trigger Time:

Keep at default unless specifically directed to change. You may want to adjust if using DSLR dashboard, but be sure of what you're doing first.

SMS Trigger Time is how long spectrum holds the camera shutter down for. Normally (default) spectrum keeps shutter pressed for the entire static time. This setting allows you to change that. While we're triggering cameras can't communicate over USB. Therefore, this is helpful if you want to shorten your trigger time and give your camera more time to communicate over USB.

## Settings Page 4/4

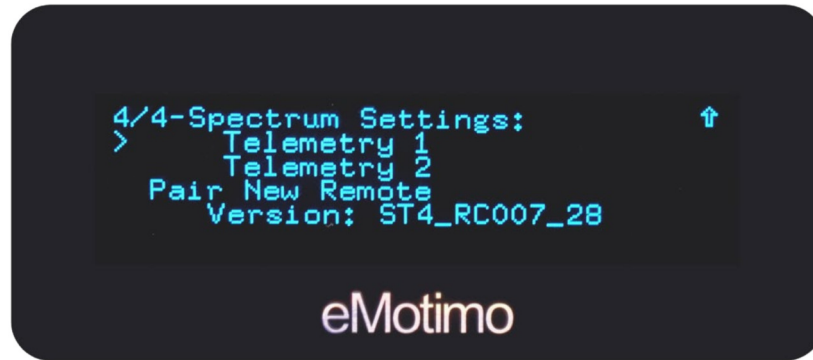

### Telemetry Menu

This screen displays live feedback from the PS4 and the **NavStick** can be read for diagnostic purposes. Nothing can be changed on this screen.

### Remote Pairing – For new remotes only

**When not to do it** – Your remote comes pre-paired from the factory. If the remote has been connected previously, please just use the quick reconnection by powering on your spectrum and pressing and releasing the remotes PS button. The remote will slow blink and turn blue, indicating a connection has been made.

**If you replace the remote.** with a new one or one that didn't ship with the spectrum, you will have to pair it once. To do that follow these steps:

- a. Power the spectrum. Using the **NavStick**, select the settings menu and move the pointer to **Pair New Remote**, but do **not** select it. The text will remain non-highlighted.
- b. On the PS4 remote, Press and hold the Share button. While still holding the share, press and hold the PS button.
- c. Watch the remote LED and once it starts a fast, short blink, release both buttons.
- d. On the spectrum, now select the Pair New Remote by hitting the NavStick center button. The selection will highlight for a moment.
- e. The remote is now pairing. When complete the LED will light blue on the remote, and the screen with “unhighlight” the text.
- f. The remote is now active. Note this procedure should not have to be run again unless the remote is paired to another system, or the remote is new, or the dongle was replaced.

### Version

This ST4 firmware version currently running is listed out here.





Learn more at:

[support.eMotimo.com](https://support.eMotimo.com)

[eMotimo.com](https://eMotimo.com)

[@eMotimo](#) [#eMotimo](#) [#spectrumST4](#) [#danadolly](#)

