

C5 Series

A/V credenza rack

unique design with integrated thermal management simplifies system design and minimize delays

features:

- Frame to Furniture™ design complements an integrator's installation workflow
- Fully assembled frames ship separately from furniture-grade panels
- Integrated, thermostatically controlled cooling quietly protects active electronics
- Available in 1, 2 and 3 bay models and two depths
- Unique design allows panels to be replaced quickly and easily
- Available in Moderno, Sota and Klasik Styles
- Standard finishes available: Veneer, High Pressure Laminate and Thermolaminate materials



specifications:

EIA Compliant 19" A/V Credenza Rack shall be Middle Atlantic Products model # C5FF-__ (refer to chart). Credenza Rack shall be available in 1, 2 or 3 bay configurations. Overall dimensions shall be 31-1/4" H x __W" x ___" D (refer to chart). Usable height shall be 14 rackspaces per bay. Rack frames shall ship fully assembled and be constructed of steel. Total weight capacity with Middle Atlantic finishing kit shall be 600 lbs., with a maximum of 350 lbs. to be placed on the top surface. Total weight capacity of the frame only (must take into account the weight of the customer supplied finishing kit) shall be 800 lbs. Each rack bay shall come equipped with 2 pairs of 11-gauge steel rackrail tapped with 10-32 mounting holes in universal EIA spacing, black e-coat finish and numbered rackspaces. Credenza rack shall have one 50 CFM thermostatically controlled proportional speed blower per bay. Exhaust air shall exit the front of the credenza for unrestricted air flow. Thermostatically controlled fans shall be powered on at 87°F and turn off at 85°F. Credenza rack shall require vent panel, model # C5-VENT-__ (refer to chart) and have venting on the top and bottom of the face of the rack. Credenza rack shall include two adjustable side mounted horizontal lacing bars for enhanced cable management. Credenza rack shall have a steel rear access panel. Credenza rack shall be finished in a durable black powder coat. Top, sides, and front doors shall ship separately from rack frame and be model # C5_K__-__DX. Top shall be constructed of 1-1/8" OR 1" thick triple refined MDF or Particle Board, sides shall be constructed of 3/4" OR 1" thick triple refined MDF or particle board, front doors shall be constructed of 3/4" thick triple refined MDF. Top, sides and front doors shall be available in a Moderno, Sota or Klasik styles. Front doors shall be solid or plexi. Top, sides and front doors shall be available in Veneer, High Pressure Laminate and Thermolaminate materials, visit middleatlantic.com for list of available finishes. Credenza rack shall include 4 fine floor casters. Credenza rack shall be GREENGUARD Gold Certified with the exception of Veneer finishes, which shall be GREENGUARD Certified. Credenza rack shall comply with the requirements of RoHS EU Directive 2002/95/EC. Credenza rack shall be manufactured by an ISO 9001 and ISO 14001 registered company. Credenza Rack frame shall be warrantied to be free from defects in material or workmanship under normal use and conditions for the lifetime of the rack, fans shall be warrantied for a period of three years and wood panels shall be warrantied for a period of 7 years.

Customizable specification clips available at middleatlantic.com

EIA/TIA COMPLIANT



PRODUCT CERTIFIED FOR
LOW CHEMICAL EMISSIONS
UL.COM/GG
UL 2818

options:

- Shelf System insert shall be model # C5-SH-SYS__ (refer to chart)
- Flip up side shelf shall be model # C5D-_F-S__-C (refer to chart)
- Slide out rotating rack bay shall have 12 rackspaces and be model C5D-SRSR12
- Adjustable Rail Bracket shall be model # C5-ARB__
- 1 bay rear door extender kit shall be model # C5-EXT-3
- Cable grommet shall be model # C5-CG-__
- Monitor mounts shall be part # C5MM1-__S-__
- Millwork kit shall be C5-MK__(frame depth - 27, 31)-__ (number of bays - 1,2,3)

what great systems are built on.™

A Group brand | legrand

Middle Atlantic Products

middleatlantic.com | middleatlantic.com

96-01195 / rev f / 3-10-15

C5 Series

basic dimensions

all dimensions in inches unless otherwise noted [all dimensions in brackets are in millimeters]

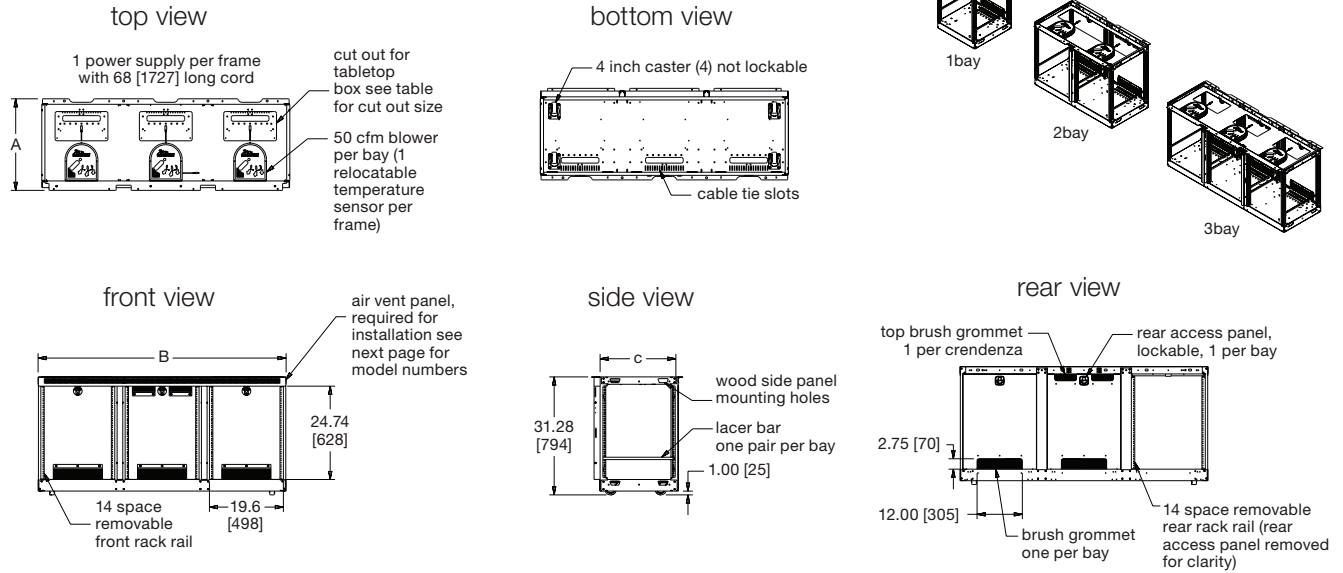

Frame Part Number	"A" Depth	"B" Width	"C" Useable Depth	Cut Out Size	Qty of Cut Outs	DbA	Fan Free Air Rated CFM	Actual Installed CFM
C5-FF27-1	24.27 [616]	21.05 [535]	20.08 [510]	7.75 [197] X 17.05 [433]	1	33	50	46
C5-FF27-2	24.27 [616]	43.39 [1102]	20.08 [510]	7.75 [197] X 39.39 [1001]	1	34	100	91
C5-FF27-3	24.27 [616]	65.75 [1670]	20.08 [510]	7.75 [197] X 14.00 [356]	3	36	150	138
C5-FF31-1	28.13 [714]	21.05 [535]	23.94 [608]	10.00 [254] X 17.05 [433]	1	33	50	46
C5-FF31-2	28.13 [714]	43.39 [1102]	23.94 [608]	10.00 [254] X 39.39 [1001]	1	43	100	91
C5-FF31-3	28.13 [714]	65.75 [1670]	23.94 [608]	10.00 [254] X 14.00 [356]	3	36	150	138

Cooling Capabilities			
Thermal Load	Temp Change (F) C5-FF27-1 / IC5-FF27-1 C5-FF31-1 / IC5-FF31-1	Temp Change (F) C5-FF27-2 / IC5-FF27-2 C5-FF31-2 / IC5-FF31-2	Temp Change (F) C5-FF27-3 / IC5-FF27-3 C5-FF31-3 / IC5-FF31-3
0.8A-100W	3.3	1.8	1.3
1.7A-200W	7.4	4.6	3.7
2.5A-300W	9.9	6.5	4.7
3.3A-400W	14.5	7.2	5.3
4.2A-500W	17.8	10.0	7.8
5.0A-600W	21.2	11.3	9.0
5.8A-700W	25.8	14.5	10.1
6.7A-800W	26.6	15.0	12.2
7.5A-900W	31.5	17.7	13.3
8.A-1000W	33.3	19.5	15.6

Note:

1. Amperage is based on actual amperage ratings, not on nameplate ratings, which have been proven to vary significantly
2. Ideal max. temp. change 15°F based on an ambient room temp. of 70°F
3. This data is made assuming that the credenza is placed against a wall in a room

what great systems are built on.™

C5 Series

basic dimensions

all dimensions in inches unless otherwise noted [all dimensions in brackets are in millimeters]

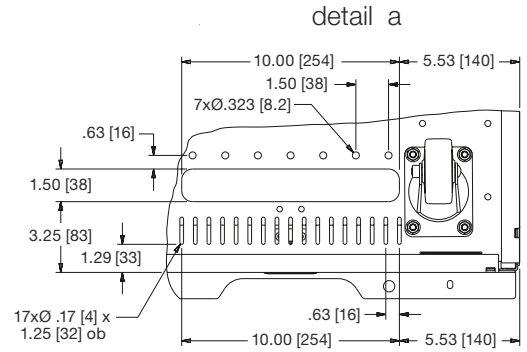
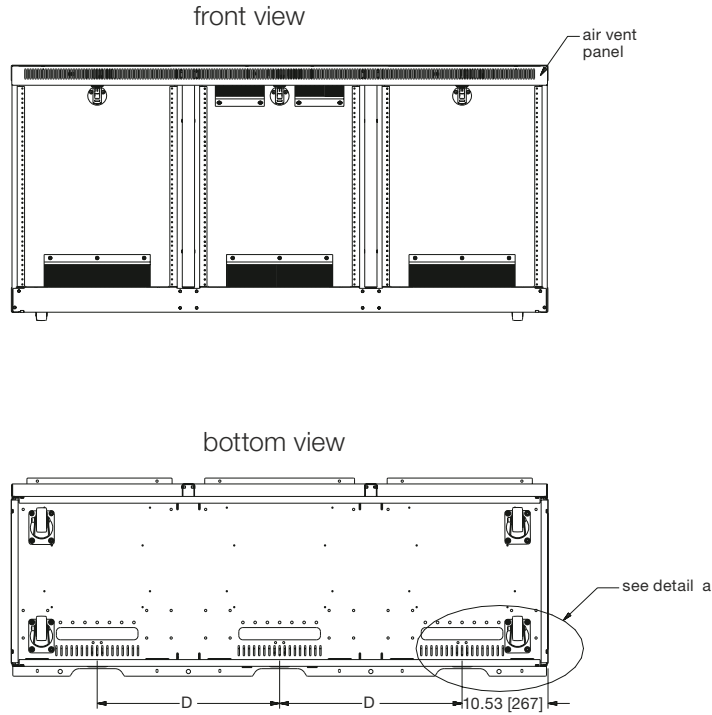

Note:
1. Air vent panel is removable and offered in different colors, required for installation.

Frame Part Number	"D" Center Distance	Air Vent Part Number	Color Code
C5-FF27-1	N/A	C5-VENT1-WH	WH White
		C5-VENT1-OW	OW Off White
		C5-VENT1-SM	SM Silver Metallic
C5-FF31-1	N/A	C5-VENT1-BK	BK Flat Black
		C5-VENT2-WH	
C5-FF27-2	22.35 [568]	C5-VENT2-OW	
		C5-VENT2-SM	
C5-FF31-2	22.35 [568]	C5-VENT2-BK	
		C5-VENT3-WH	
C5-FF27-3	22.35 [568]	C5-VENT3-OW	
		C5-VENT3-SM	
C5-FF31-3	22.35 [568]	C5-VENT3-BK	

what great systems are built on.™

C5 Series Sota Style: basic dimensions

all dimensions in inches unless otherwise noted [all dimensions in brackets are in millimeters]

Sota Style: HPL and Veneer

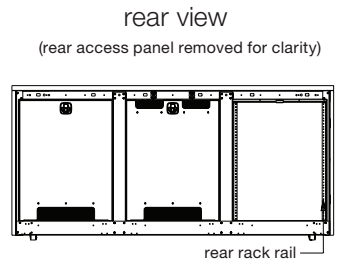
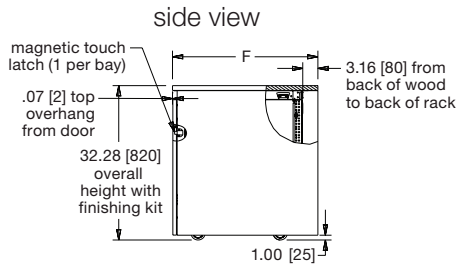
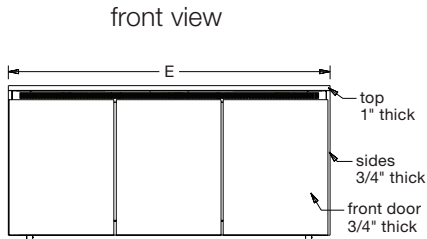
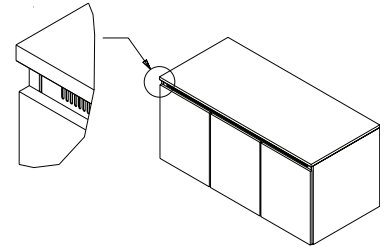
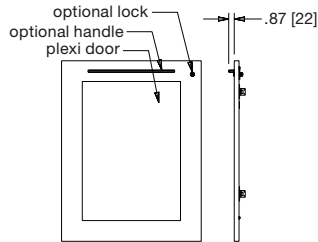
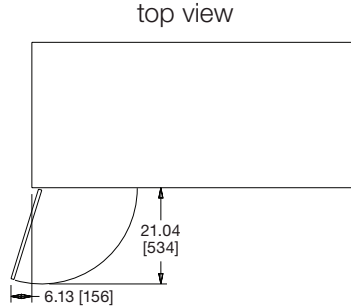

Sota Style: Thermolaminate

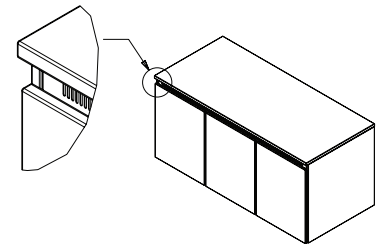
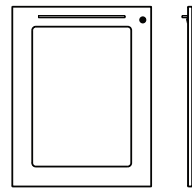
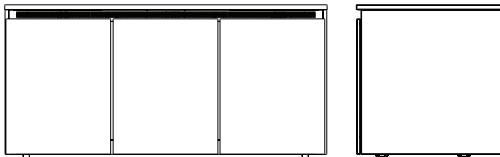

Finishing Kit Number	Door Type	"E" Width	"F" Depth	Compatible With
C5-SK27-1PDX	plexi	22.8 [580]	26.6 [676]	C5-FF27-1
C5-SK27-1SDX	solid			
C5-SK27-2PDX	plexi	45.1 [1146]	26.6 [676]	C5-FF27-2
C5-SK27-2SDX	solid			
C5-SK27-3PDX	plexi	67.5 [1715]	26.6 [676]	C5-FF27-3
C5-SK27-3SDX	solid			
C5-SK31-1PDX	plexi	22.8 [580]	30.4 [773]	C5-FF31-1
C5-SK31-1SDX	solid			
C5-SK31-2PDX	plexi	45.1 [1146]	30.4 [773]	C5-FF31-2
C5-SK31-2SDX	solid			
C5-SK31-3PDX	plexi	67.5 [1715]	30.4 [773]	C5-FF31-3
C5-SK31-3SDX	solid			

X = suffix with V for Veneer finish, suffix with H for HPL finish, suffix with T for Thermolaminate

Notes:

1. Finishing kits require a finish. Please refer to middleatlantic.com for finish options
2. 2 Bay credenzas have a left and right door by default, 3 and 1 bay credenzas have left doors by default.

Accessory Part Number	Accessory Type	Color Code
ACC-LOCK1-BKX	lock	Black
ACC-LOCK1-MAX	lock	Modern Aluminum (Matte Finish)
ACC-LOCK1-WHX	lock	White
ACC-HANDLE1-MAX	handle	Modern Aluminum (Matte Finish)

X = suffix with V for Veneer finish, suffix with H for HPL finish, suffix with T for Thermolaminate

what great systems are built on.™

C5 Series Moderno Style: basic dimensions

all dimensions in inches unless otherwise noted [all dimensions in brackets are in millimeters]

top view

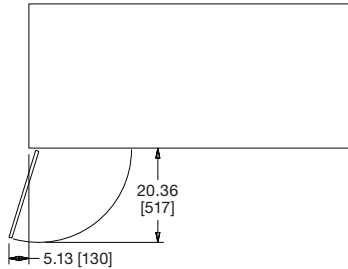

Moderno Style: HPL and Veneer

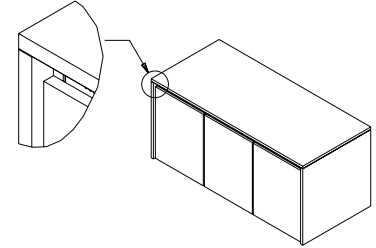
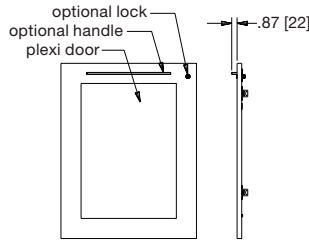

front view



side view

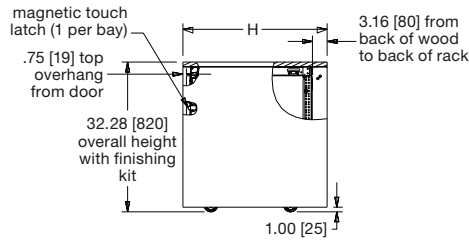

rear view

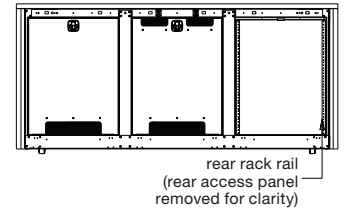

Moderno Style: Thermolaminate

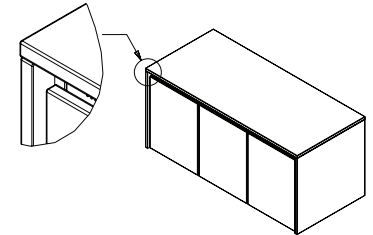
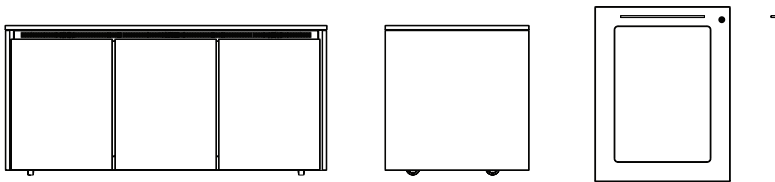

Finishing Kit Number	Door Type	"G" Width	"H" Depth	Compatible With
C5-MK27-1PDX	plexi	24.8 [630]	27.3 [694]	C5-FF27-1
C5-MK27-1SDX	solid			
C5-MK27-2PDX	plexi	47.1 [1197]	27.3 [694]	C5-FF27-2
C5-MK27-2SDX	solid			
C5-MK27-3PDX	plexi	69.5 [1766]	27.3 [694]	C5-FF27-3
C5-MK27-3SDX	solid			
C5-MK31-1PDX	plexi	24.8 [630]	31.1 [790]	C5-FF31-1
C5-MK31-1SDX	solid			
C5-MK31-2PDX	plexi	47.1 [1197]	31.1 [790]	C5-FF31-2
C5-MK31-2SDX	solid			
C5-MK31-3PDX	plexi	69.5 [1766]	31.1 [790]	C5-FF31-3
C5-MK31-3SDX	solid			

X = suffix with V for Veneer finish, suffix with H for HPL finish, suffix with T for Thermolaminate

Notes:

1. Finishing kits require a finish. Please refer to middleatlantic.com for finish options
2. 2 Bay credenzas have a left and right door by default, 3 and 1 bay credenzas have left doors by default.

Accessory Part Number	Accessory Type	Color Code
ACC-LOCK1-BKX	lock	Black
ACC-LOCK1-MAX	lock	Modern Aluminum (Matte Finish)
ACC-LOCK1-WHX	lock	White
ACC-HANDLE1-MAX	handle	Modern Aluminum (Matte Finish)

X = suffix with V for Veneer finish, suffix with H for HPL finish, suffix with T for Thermolaminate

what great systems are built on.™



A Group brand | Legrand



Middle Atlantic Products

middleatlantic.com | middleatlantic.ca

C5 Series Klasik Style:

basic dimensions

all dimensions in inches unless otherwise noted [all dimensions in brackets are in millimeters]

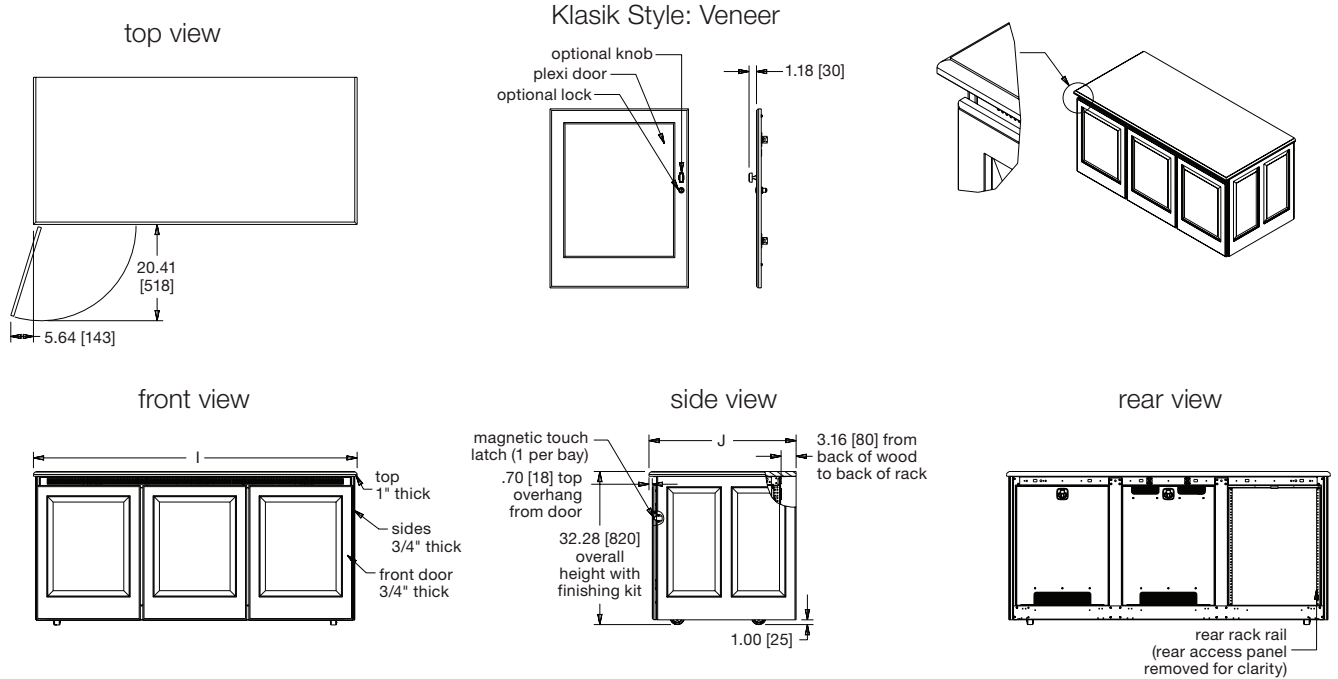

Klasik Style: Thermolaminate

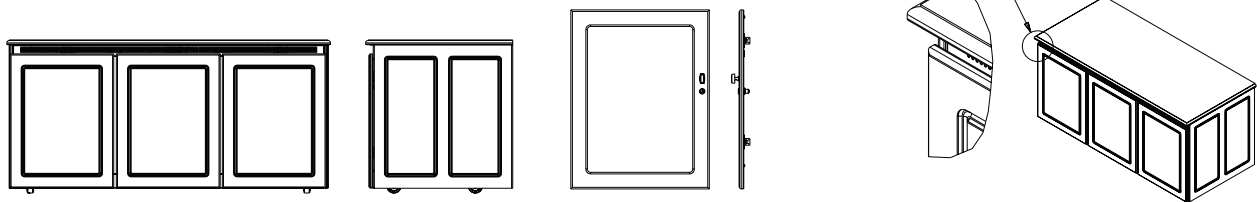

Finishing Kit Number	Door Type	"I" Width	"J" Depth	Compatible With
C5-KK27-1PDX	plexi	23.6 [600]	27.2 [691]	C5-FF27-1
C5-KK27-1SDX	solid			C5-FF27-1
C5-KK27-2PDX	plexi	46.0 [1169]	27.2 [691]	C5-FF27-2
C5-KK27-2SDX	solid			C5-FF27-2
C5-KK27-3PDX	plexi	68.3 [1735]	27.2 [691]	C5-FF27-3
C5-KK27-3SDX	solid			C5-FF27-3
C5-KK31-1PDX	plexi	23.6 [600]	31.1 [790]	C5-FF31-1
C5-KK31-1SDX	solid			C5-FF31-1
C5-KK31-2PDX	plexi	46.0 [1169]	31.1 [790]	C5-FF31-2
C5-KK31-2SDX	solid			C5-FF31-2
C5-KK31-3PDX	plexi	68.3 [1735]	31.1 [790]	C5-FF31-3
C5-KK31-3SDX	solid			C5-FF31-3

X = suffix with V for Veneer finish, suffix with H for HPL finish, suffix with T for Thermolaminate

Notes:

1. Finishing kits require a finish. Please refer to middleatlantic.com for finish options
2. 2 Bay credenzas have a left and right door by default, 3 and 1 bay credenzas have left doors by default.

Accessory Part Number	Accessory Type	Color Code
ACC-LOCK1-SNX	lock	satin nickel
ACC-LOCK1-CBX	lock	classic bronze
ACC-KNOB1-CNX	knob	classic nickel
ACC-KNOB1-CBX	knob	classic bronze

X = suffix with V for Veneer finish thermolaminate does not use an "X" suffix

what great systems are built on.™

C5 Series: basic dimensions

all dimensions in inches unless otherwise noted [all dimensions in brackets are in millimeters]

1" x 7" cable grommet on top and bottom of c5 extender (p/n: C5-EXT-3)

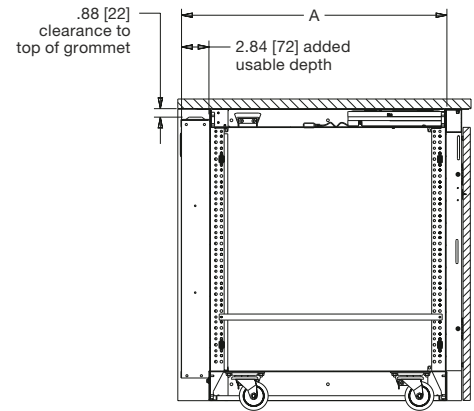
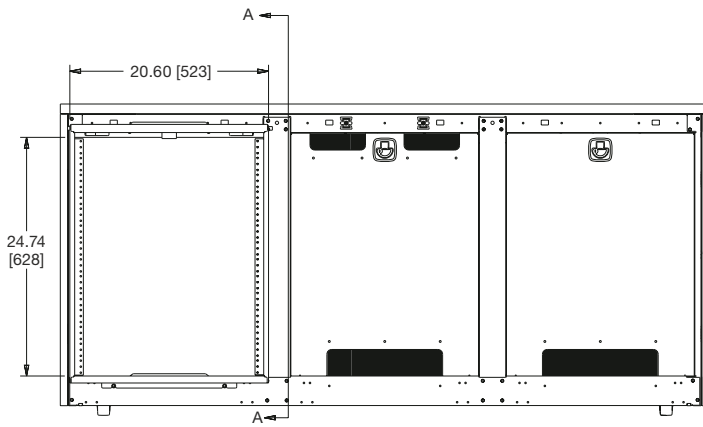
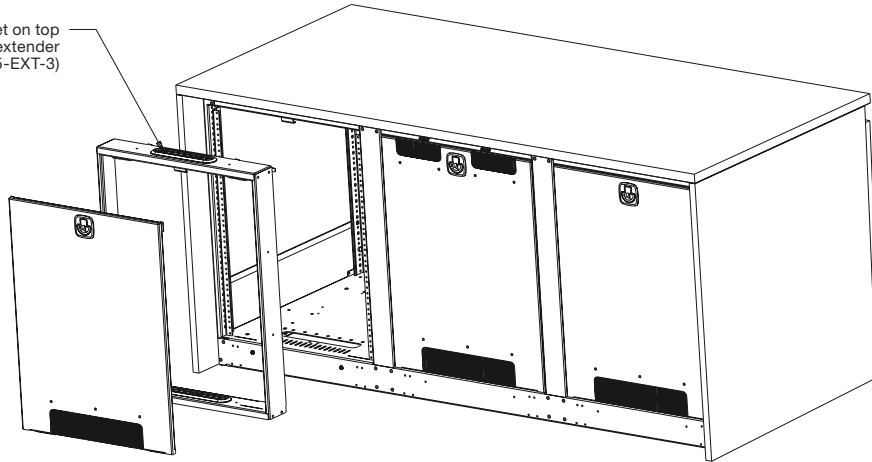

Frame Part Number	"A" Combined Depth
C5-FF27-1, C5-FF27-2, C5-FF27-3	23.65 [601]
C5-FF31-1, C5-FF31-2, C5-FF31-3	27.51 [699]

what **great systems** are built on.™



A Group brand | **legrand**



Middle Atlantic Products
middleatlantic.com | middleatlantic.ca

C5 Series: basic dimensions

all dimensions in inches unless otherwise noted [all dimensions in brackets are in millimeters]

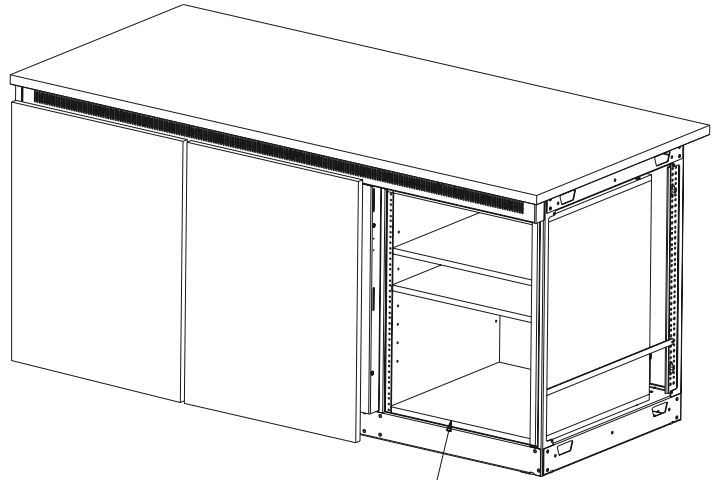
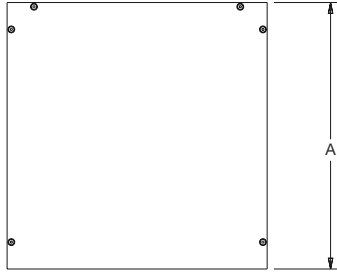

shelf shown installed in c5 credenza with door and side panel removed for clarity

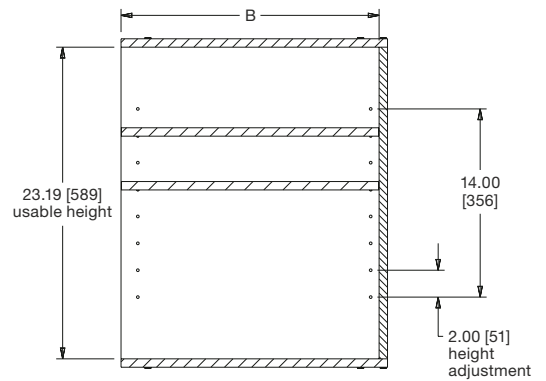
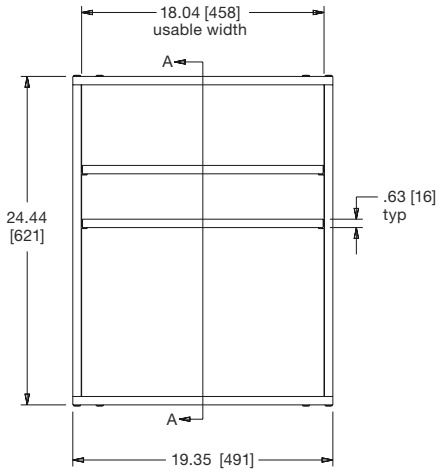

Part Number	"A" Depth	"B" Usable Depth	Compatible Frames
C5-SH-SYS27	15.97 [406]	15.34 [390]	C5-FF27-1, C5-FF27-2, C5-FF27-3
C5-SH-SYS31	19.83 [504]	19.20 [488]	C5-FF31-1, C5-FF31-2, C5-FF31-3

what **great systems** are built on.™

C5 Series: basic dimensions

all dimensions in inches unless otherwise noted [all dimensions in brackets are in millimeters]

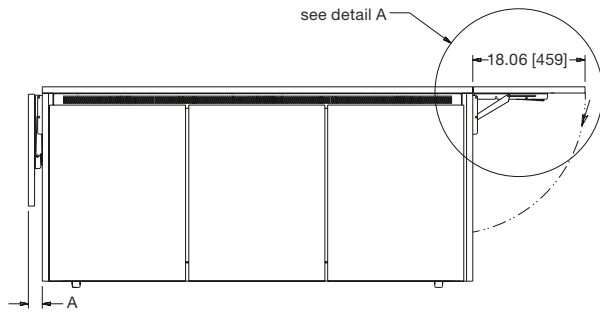

same shelf can be located on the left or right side of credenza

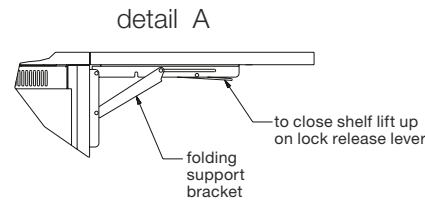
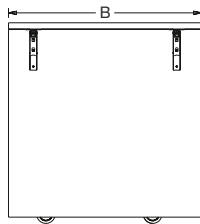
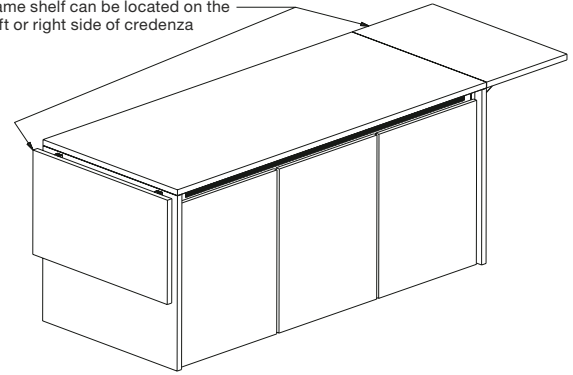

Part Number	Compatible Frames	Compatible Styles	Compatible Finish Type	"A" Overhang	"B" Depth
C5-MFS27-V	C5-FF27-1, C5-FF27-2, C5-FF27-3	Moderno	Veneer	2.25 [57.15]	27.3 [694]
C5-MFS31-V	C5-FF31-1, C5-FF31-2, C5-FF31-3	Moderno	Veneer	2.25 [57.15]	31.1 [790]
C5-MFS27-H	C5-FF27-1, C5-FF27-2, C5-FF27-3	Moderno	HPL	2.25 [57.15]	27.3 [694]
C5-MFS31-H	C5-FF31-1, C5-FF31-2, C5-FF31-3	Moderno	HPL	2.25 [57.15]	31.1 [790]
C5-MFS27-T	C5-FF27-1, C5-FF27-2, C5-FF27-3	Moderno	Thermolaminate	2.25 [57.15]	27.3 [694]
C5-MFS31-T	C5-FF31-1, C5-FF31-2, C5-FF31-3	Moderno	Thermolaminate	2.25 [57.15]	31.1 [790]
C5-SFS27-V	C5-FF27-1, C5-FF27-2, C5-FF27-3	Sota	Veneer	2.25 [57.15]	26.6 [676]
C5-SFS31-V	C5-FF31-1, C5-FF31-2, C5-FF31-3	Sota	Veneer	2.25 [57.15]	30.4 [773]
C5-SFS27-H	C5-FF27-1, C5-FF27-2, C5-FF27-3	Sota	HPL	2.25 [57.15]	26.6 [676]
C5-SFS31-H	C5-FF31-1, C5-FF31-2, C5-FF31-3	Sota	HPL	2.25 [57.15]	30.4 [773]
C5-SFS27-T	C5-FF27-1, C5-FF27-2, C5-FF27-3	Sota	Thermolaminate	2.25 [57.15]	26.6 [676]
C5-SFS31-T	C5-FF31-1, C5-FF31-2, C5-FF31-3	Sota	Thermolaminate	2.25 [57.15]	30.4 [773]
C5-KFS27-V	C5-FF27-1, C5-FF27-2, C5-FF27-3	Klasik	Veneer	2.25 [57.15]	27.2 [691]
C5-KFS31-V	C5-FF31-1, C5-FF31-2, C5-FF31-3	Klasik	Veneer	2.25 [57.15]	31.1 [790]
C5-KFS27-T	C5-FF27-1, C5-FF27-2, C5-FF27-3	Klasik	Thermolaminate	2.25 [57.15]	27.2 [691]
C5-KFS31-T	C5-FF31-1, C5-FF31-2, C5-FF31-3	Klasik	Thermolaminate	2.25 [57.15]	31.1 [790]

what great systems are built on.™

C5 Series: basic dimensions

all dimensions in inches unless otherwise noted [all dimensions in brackets are in millimeters]

top view

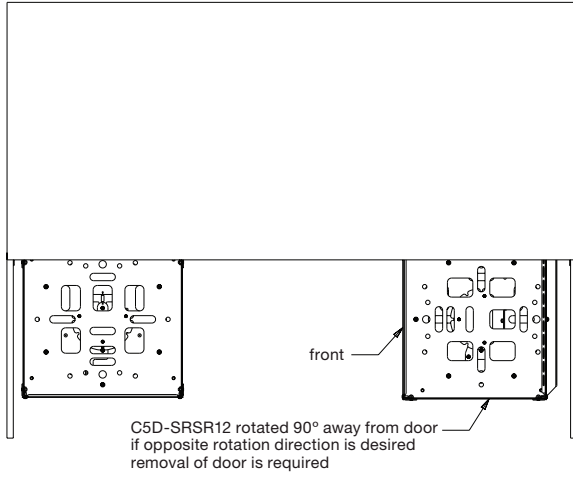

rack removes for easy integration

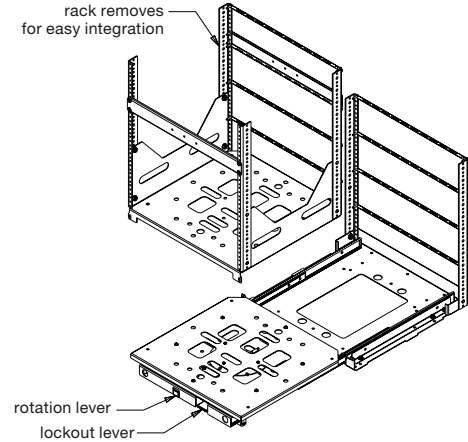

front view

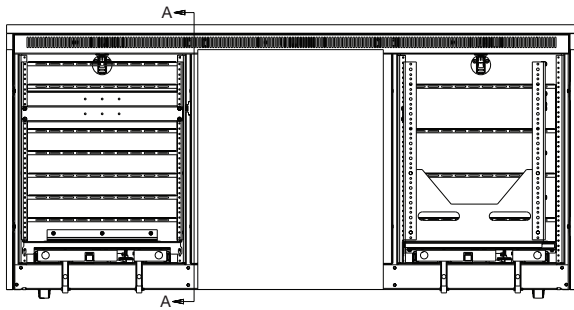

top view

for easy installation and servicing
locks in place 0°, 60° and 90°

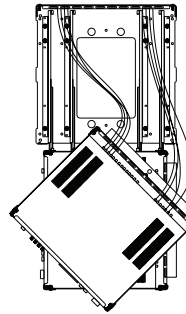

side view
closed position

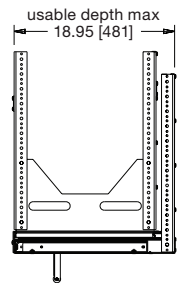

side view

fully extended position

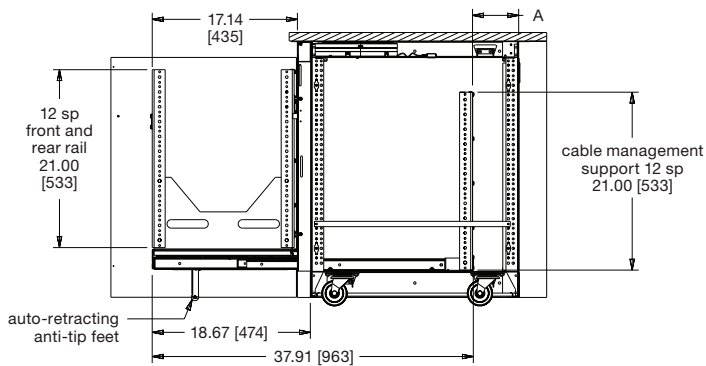

Frame Part Number	"A" Rack Rail & Rear Access Panel Distance
C5-FF27-3, C5-FF27-2, C5-FF27-1	1.55 [40]
C5-FF31-3, C5-FF31-2, C5-FF31-1	5.41 [138]

what great systems are built on.™

A Group brand | **legrand**

Middle Atlantic Products
middleatlantic.com | middleatlantic.ca

C5 Series: basic dimensions

all dimensions in inches unless otherwise noted [all dimensions in brackets are in millimeters]

top view 3 bay

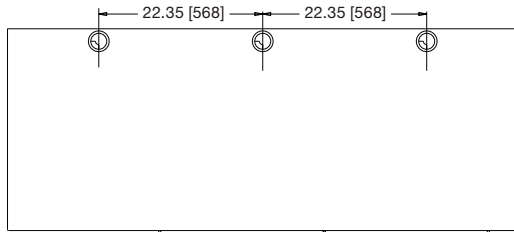

top view 2 bay

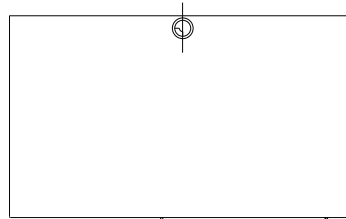

top view 1 bay

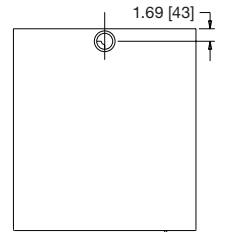

bottom view

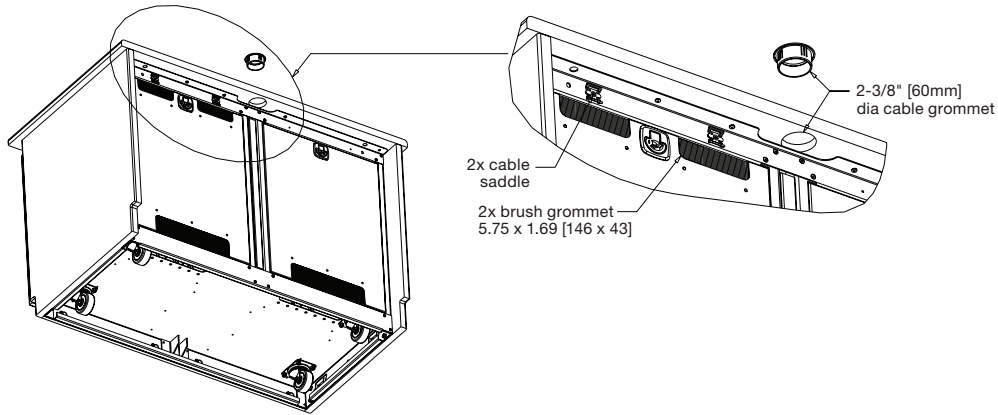

Note:
when optional monitor mount is used, CG locations are eliminated where monitor is placed

Part Number	Respective Wood Finish
C5-CG-H	HPL
C5-CG-T	Thermolaminate
C5-CG-V	Veneer

C5 Series: basic dimensions

all dimensions in inches unless otherwise noted [all dimensions in brackets are in millimeters]

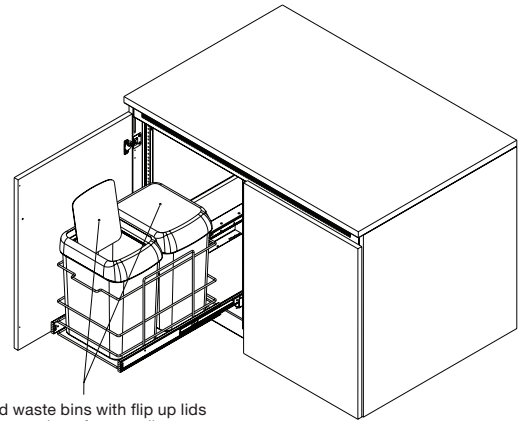
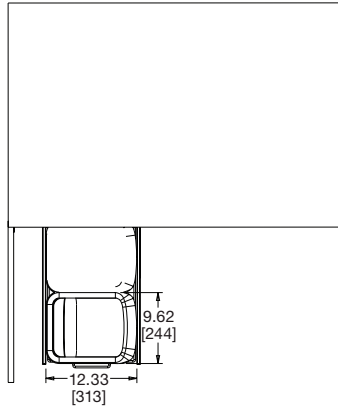

two contoured waste bins with flip up lids
color coded blue and tan for recycling ease
22 liter capacity each

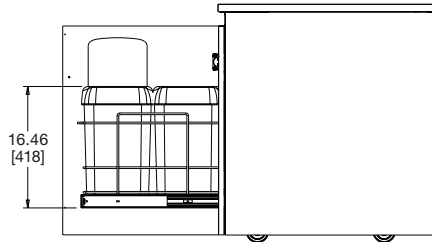
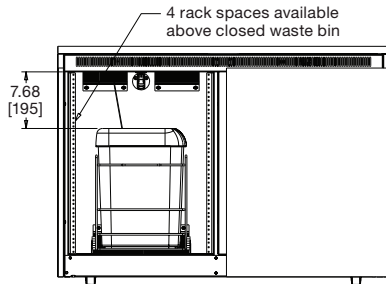

Note:
waste bin can be installed in any bay in all C5 credenzas

what **great systems** are built on.™

A Group brand | **legrand**

MA

Middle Atlantic Products

middleatlantic.com | middleatlantic.ca

C5 Series: Monitor Mount

basic dimensions

all dimensions in inches unless otherwise noted [all dimensions in brackets are in millimeters]

display mount bracket hole pattern

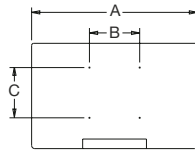
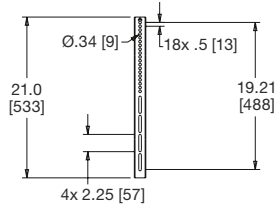

single monitor mount

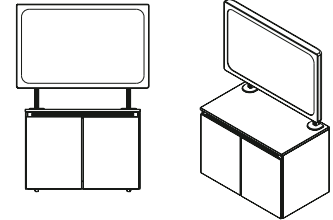

Part Number	A Display Width	B VESA Pattern Accommodation	C VESA Pattern Accommodation
C5MM1-80S-2BK C5MM1-80S-327BK C5MM1-80S-331BK	80 [2032] and under	up to VESA 900	up to VESA 400
C5MM1-55D-2BK C5MM1-55D-327BK C5MM1-55D-331BK	47 [1194] and under 55 [1397] and under	up to VESA 600 up to VESA 400	up to VESA 400 up to VESA 400
C5MM1-70D-327BK C5MM1-70D-331BK	63 [1600] and under 71 [1803] and under	up to VESA 600 up to VESA 400	up to VESA 400 up to VESA 400

Monitor Mount Part Number	Compatible w/ Frame Model No.
C5MM1-80S-2BK C5MM1-55D-2BK	C5-FF27-2 C5-FF31-2
C5MM1-80S-327BK C5MM1-55D-327BK C5MM1-70D-327BK	C5-FF27-3
C5MM1-80S-331BK C5MM1-55D-331BK C5MM1-70D-331BK	C5-FF31-3

dual monitor mount

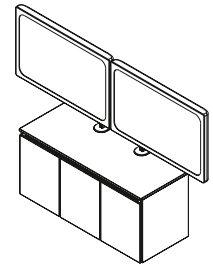
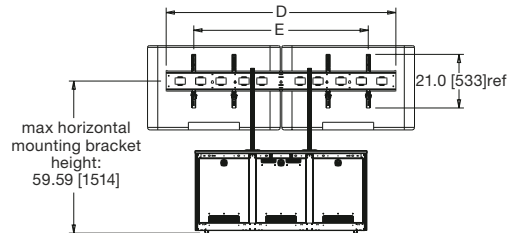
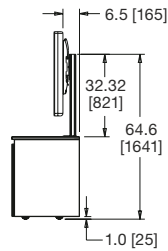
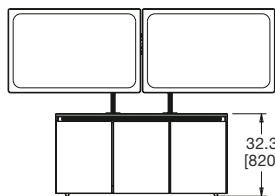

Part Number	Single or Dual Displays	Display Size	Max Display Weight Lb [Kg]	D Horizontal Length	E Max Distance Outer Verticals
C5MM1-80S-2BK C5MM1-80S-327BK C5MM1-80S-331BK	single	42 [1067] to 70 [1778]	225 [102]	38.00 [965]	35.75 [908]
C5MM1-55D-2BK C5MM1-55D-327BK C5MM1-55D-331BK	dual	42 [1067] to 55 [1397]	160 [72] (total: 320 [145])	74.00 [1880]	71.75 [1822]
C5MM1-70D-327BK C5MM1-70D-331BK	dual	56 [1422] to 65 [1651]	160 [72] (total: 320 [145])	90.00 [2286]	87.75 [2229]

C5 Series: Adjustable Rail Bracket

basic dimensions

all dimensions in inches unless otherwise noted [all dimensions in brackets are in millimeters]

front view

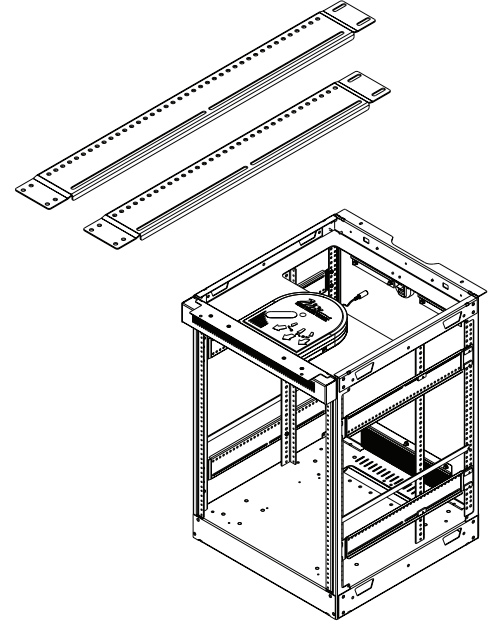
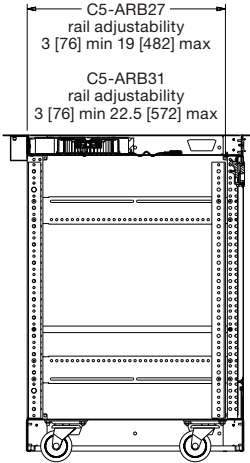
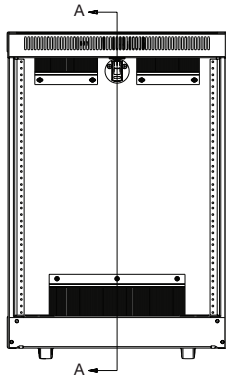

side view
rear rail shown in max position

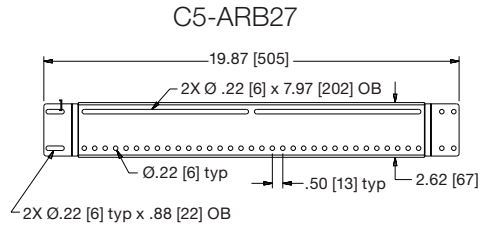
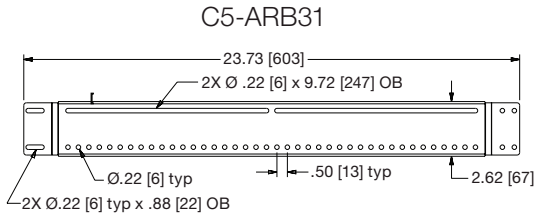

Part Number	Compatible With
C5-ARB27	C5-FF27-1 C5-FF27-2 C5-FF27-3
C5-ARB31	C5-FF31-1 C5-FF31-2 C5-FF31-3