

FUJIFILM

JA	冷却ファン
EN	Cooling Fan
FR	Ventilateur
DE	Kühlmodul
ES	Ventilador
IT	Ventola di Raffreddamento
FAN-001	

BL00005143-100

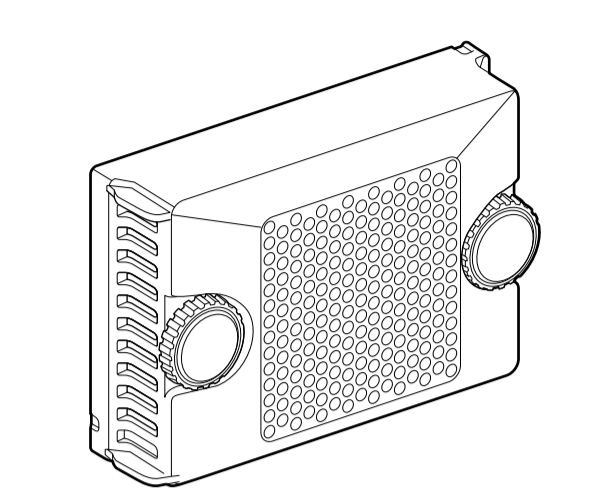

JA 使用説明書

このたびは弊社製品をお買い上げいただき、ありがとうございます。本製品はカメラ用空冷ファンです。本製品をカメラに取り付けて空冷ファンとしてご使用いただけます。保守、点検または修理が必要な場合は、お買い上げ店または修理サービスセンターにご依頼ください。

本製品が対応するカメラについては、以下の弊社 WEB サイトをご参照ください。

https://fujifilm-x.com/ja-jp/support/compatibility/accessories/

本製品を使用するときは、以下の弊社 WEB サイト上にあるカメラの「使用説明書」のうち、冷却ファンの項目をあわせてお読みください。





https://fujifilm-x.com/ja-jp/support/manual/cameras/





安全上のご注意（必ずお守りください）

●ご使用の前に必ずこの「使用説明書」、特に「安全上のご注意」と弊社 WEB サイト上にあるカメラの「使用説明書」をよくお読みの上、正しくお使いください。

●お読みになったあとは、いつでも見られるところに必ず保管してください。

絵表示について この使用説明書および製品への表示では、製品を安全に正しくお使いいただき、あなたや他の人々への危害や財産への損害を未然に防止するために、いろいろな絵表示をしています。その表示と意味は次のようになっています。内容をよく理解してから本文をお読みください。

 警告	 注意
この表示を無視して誤った取り扱いをすると、人が死亡または重傷を負う可能性が想定される内容を示しています。	この表示を無視して誤った取り扱いをすると、人が傷害を負う可能性が想定される内容および物的損害のみの発生が想定される内容を示しています。
 このような絵表示は、気を付けていただきたい「注意喚起」内容です。	
 このような絵表示は、してはけない「禁止」内容です。	
 このような絵表示は、必ず実行していただく「強制」内容です。	

 警告
 異常が起きたらカメラの電源を切り、カメラの電池を外す。 煙が出ている、異臭がするなど異常状態のまま使用すると、火災・感電の原因になります。お買上げ店にご相談ください。
 内部に水や異物を落とさない。 水・異物が内部に入ったら、カメラの電源を切ってください。そのまま使用すると、ショートして火災・感電の原因になります。お買上げ店にご相談ください。
 風呂、シャワー室では使用しない。 火災・感電の原因になります。

 **分解や改造は絶対にしない（ケースは絶対に開けない）。**
火災・感電の原因になります。

 **落下などによって破損し、内部が露出したときは、露出部に手を触れない。**
感電したり、破損だけがをする原因になります。感電やけがに注意して速やかに電池を取り出し、お買上げ店にご相談ください。

 **不安定な場所に置かない。**
バランスがくずれて倒れたり落下したりして、けがの原因になります。

 **移動中の使用はしない。**

 **雷が鳴りだしたら金属部分に触れない。**
落雷すると誘電雷により感電の原因になります。

 **化粧品や薬品の入った容器のそばで機器を使用しない。**
こぼれたり、機器の中に入った場合、火災、感電または傷害の原因になります。

 **引火性・可燃性・爆発性ガスがある場所や、工場など粉塵が発生する場所では、使用しない。**
爆発や火災の原因になります。







 **油煙、湯気、湿気、ほこりなどが多い場所に置かない。**
火災・感電の原因になることがあります。

 **異常な高温になる場所に置かない。**
直射日光や火などの高温にさらさない。
窓を閉めきった自動車の中や、直射日光が当たる場所に置かないでください。火災の原因になることがあります。

 **衝撃を与えない。**
運搬や使用の際に落下や転倒などの衝撃を与えないでください。製品故障や性能劣化のおそれがあります。

 **ファンの吸排気口をテープなどで塞がない。**
冷却性能の低下や、故障の原因になります。

 **小さいお子様の手の届くところに置かない。**
けがの原因になることがあります。

 注意
 本製品の上に重いものを置かない。 バランスがくずれて倒れたり、落下したりして、けがの原因になることがあります。
 温度が高くなる部分に直接触れない。
 ベンジン、シンナー、アルコールなどで拭かない。 火災・感電の原因になります。
 火のついたろうそくなど、いかなる発火源も機器の上には置かない。
 磁気の影響に注意。 本製品には、磁気カードや時計など磁気の影響を受けやすいものは近づけないでください。 近づけると、故障やデータ消失などの恐れがあります。
 本製品を廃棄する場合の処理方法については最寄りの自治体の手順に従うこと。

使用上のご注意

●**避けて欲しい保存場所**

次のような場所での本製品の使用・保管は避けてください。

- 雨天下、湿気やゴミ、ほこりの多いところ
- 直射日光の当たるところや夏場の密閉した自動車内など、高温になるところ
- 極端に寒いところ
- 振動の激しいところ
- 油煙や湯気の当たるところ
- 強い電磁場の発生するところ（放送塔、送電線、レーダー、モーター、トランス、磁石のそばなど）
- 防虫剤などの薬品やゴム、ビニール製品に長時間接触するところ

●**冠水、浸水、砂かぶりにご注意**

水や砂は本製品の天敵です。海辺、水辺などでは、水や砂がかからないようにしてください。また、水でぬれた場所の上に、本製品を置かないでください。水や砂が本製品の内部に入りますと、故障の原因になるほか、修理できなくなることもあります。

●**結露（つゆつき）にご注意**

本製品を寒いところから急に暖かいところに持ち込んだときなどに、本製品内外部やレンズなどに水滴がつくこと（結露）があります。このようなときは電源を切り、水滴がなくなつてからお使いください。

●**ファンが動作しているときに髪の手などを近づけないでください。** 巻き込まれる可能性があります。

●**ファンをカメラ本体に取り付けると、液晶モニターが開いた状態になりますので、液晶モニターへの過度な力、落下、衝撃には特に注意してください。**

●**ファンの吸排気口の近くに遮蔽物があると、冷却性能が低下します。**

●**ご使用の環境温度、使用時間により温度が高くなる場合があります。特に冷却ファンを取り外す時に高温になっている場合がありますので十分にご注意ください。**

●**ファンの端子には触らないようにしてください。** 持ち運ぶ際は、本製品の端子部に端子キャップをかぶせて保護してください。

カメラへの取り付け

取り付け方法は弊社 WEB サイト上にあるカメラの「使用説明書」のうち、冷却ファンの項目をご参照ください。

●ファンの取り付け、取り外しはカメラ本体の電源を切った状態で行ってください。感電や破損のおそれがあります。

●取り付けはしっかり行ってください。ネジの締め付けが十分でないと、ファンとカメラ本体の間に隙間が生じ、冷却性能が低下します。また、使用中にネジが緩んできた場合は、再度ネジを締め付けてください。

●本製品をカメラから取り外した時は、必ず「冷却ファン用端子カバー」をカメラに取り付けてください。

主な仕様	
外形寸法 (幅×高さ×厚み)	79.5 mm × 54.2 mm × 24.3 mm (突起物を除く)
本体質量	約 104 g
動作環境	・ 温度：-10℃～+40℃ ・ 湿度：10％～80％（結露しないこと）

*仕様、性能は、予告なく変更することがありますのでご了承ください。使用説明書の記載の誤りなどについての補償はご容赦ください。

EN ENGLISH

Thank you for purchasing this Fujifilm product, a camera cooling fan that can be mounted on the camera to provide air cooling. For inspection, maintenance, and repair, consult the original retailer or bring the unit to a Fujifilm service center.

For a list of compatible cameras, visit:
https://fujifilm-x.com/support/compatibility/accessories/
When using this product, refer both to this guide and to the section on cooling fans in the camera *Owner's Manual* available from the website below.
https://fujifilm-x.com/support/manual/cameras/

For Customers in the U.S. A.

FC

FCC Statement:
This device complies with part 15 of the FCC Rules. Operation is subject to the following two conditions:(1)This device may not cause harmful interference, and (2) this device must accept any interference received, including interference that may cause undesired operation.

This equipment has been tested and found to comply with the limits for a Class B digital device, pursuant to Part 15 of the FCC Rules. These limits are designed to provide reasonable protection against harmful interference in a residential installation. This equipment generates, uses, and can radiate radio frequency energy and, if not installed and used in accordance with the instructions, may cause harmful interference to radio communications. However it is not guaranteed that interference will not occur in a particular installation. If this equipment does cause harmful interference to radio or television reception, which can be determined by turning the equipment off and on, the user is encouraged to try to avoid the interference by one or more of the following measures;

- Reorient or relocate the receiving antenna.
- Increase the separation between the equipment and receiver.
- Connect the equipment into an outlet on a circuit different from the one to which the receiver is connected.
- Consult the dealer or an experienced radio/TV technician for help.

You are cautioned that any changes or modifications not expressly approved in this manual could void your warranty.

For Customers in Canada

CAUTION:
CANICES-3(B)/NMB-3(B)
This Class B digital apparatus meets all requirements of the Canadian interference-Causing Equipment Regulations.

Disposal of Electrical and Electronic Equipment in Private Households

In the European Union, Norway, Iceland and Liechtenstein: This symbol on the product, or in the manual and in the warranty, and/or on its packaging indicates that this product shall not be treated as household waste. Instead it should be taken to an applicable collection point for the recycling of electrical and electronic equipment.

By ensuring this product is disposed of correctly, you will help prevent potential negative consequences to the environment and human health, which could otherwise be caused by inappropriate waste handling of this product.

EC Declaration of Conformity





We
Name: FUJIFILM Europe GmbH
Address: Heesenstrasse 31, 40549 Dusseldorf, Germany

declare that the product
Manufacturer's Name: FUJIFILM Corporation
Manufacturer's Address: 7-3, AKASAKA 9-CHOME, MINATO-KU, TOKYO, 107-0052 JAPAN
following the provision of the EMC Directive (2014/30/EU) and Low Voltage Directive (2014/35/EU).



CE

















WARNINGS AND CAUTIONS (PLEASE OBSERVE.)







- Please read the operating instructions in this *Owner's Manual*, especially the warnings and cautions, as well as the operating instructions in the camera's *Owner's Manual* (available from the Fujifilm website) in order to operate this product correctly.
- After reading, be sure to keep this manual in a safe place where you can refer to it easily.
- In order to ensure that this product is used safely and correctly, and to prevent danger to yourself and other persons or damage to property, various icons are used in this *Owner's Manual* and on the product. These icons and their meanings are given here. Please read the explanations and get a good understanding of the meaning of each one before you read the main text of this manual.

 WARNING	 CAUTION
This icon indicates a situation which could result in death or severe injury to persons who disregard these instructions and handle the product incorrectly.	This icon indicates a situation which could result in injury to persons or physical damage to objects, if these instructions are disregarded and the product is handled incorrectly.
Example of Icons	
 Triangular icons tell you that this information requires attention ("Important").	 Circular icons with a diagonal bar tell you that the action indicated is prohibited ("Prohibited").
	 Filled circles with an exclamation mark indicate an action that must be performed ("Required").

The symbols on the product (including the accessories) represent the following:

	AC
	DC
	Class II equipment (The construction of the product is double-insulated.)

 WARNING
 Turn the camera off and remove the battery should you notice any abnormalities. Continuing to use the product when it is emitting smoke or unusual odors or otherwise functioning abnormally could result in fire or electric shock. Contact your Fujifilm dealer.
 Do not allow water or foreign objects to enter the product. Should water find or other foreign matter find its way in, turn the camera off. Continued use could cause fire or electric shock. Contact your Fujifilm dealer.
 Do not use the product in the bathroom or shower. This can cause a fire or electric shock.
 Do not disassemble or modify (never open the case). Failure to observe this precaution can cause fire or electric shock.
 Should the case break open as the result of a fall or other accident, do not touch the exposed parts. Failure to observe this precaution could result in electric shock or in injury from touching the damaged parts. Remove batteries immediately, taking care to avoid injury or electric shock, and take the product to the point of purchase for consultation.
 Do not place the product on an unstable surface. This could cause it to fall or tip over and cause injury.
 Never attempt to use the product while in motion.
 Do not touch any metal parts of the product during a thunderstorm. This can cause an electric shock due to induced current from the lightning discharge.
 Do not use the product in the vicinity of containers for cosmetics or pharmaceuticals. The contents could spill or otherwise find their way into the product, resulting in fire, electric shock, or injury.
 Do not use in the presence of flammable objects, explosive gases, or dust. Failure to observe this precaution could cause fire.
 Do not use the product in locations affected by oil fumes, steam, humidity or dust. This can cause a fire or electric shock.
 Do not leave the product in locations subject to extremely high temperatures. Do not expose the product to direct sunlight or flame or otherwise subject it to high temperatures. Do not leave the product in locations such as a sealed vehicle or in direct sunlight. This can cause a fire.
 Do not subject the product to physical shocks. Do not subject the product to physical shocks, for example by dropping or knocking it over during transport or use. Failure to observe this precaution could result in product malfunction or impaired performance.
 Do not obstruct the exhaust vent by covering it with tape or other objects. Failure to observe this precaution could interfere with cooling or cause product malfunction.
 Keep out of the reach of small children. This product could cause injury in the hands of a child.

 CAUTION
 Do not place heavy objects on the product. This can cause the heavy object to tip over or fall and cause injury.
 Avoid direct contact with areas of the product that become hot.
 Do not use alcohol, thinner, benzene, or other volatile chemicals to clean the product. This can cause fire or electric shock.
 No naked flame sources such as lighted candles should be placed on the apparatus.
 Keep away from equipment sensitive to magnetic fields. This product may affect watches, magnetic stripe cards, and other equipment sensitive to magnetic fields. Failure to observe this precaution could result in malfunction or loss of data.
 Dispose of the product in accord with location regulations.

Product Care

To ensure continued enjoyment of the product, observe the following precautions.

●**Storage and Use**

- Do not store or use the product in locations that are:
 - exposed to rain or extremely humid, dirty, or dusty
 - exposed to direct sunlight or very high temperatures, such as in a closed vehicle on a sunny day
 - extremely cold
 - subject to strong vibration
 - exposed to smoke or steam
 - exposed to strong magnetic fields, such as near a broadcasting antenna, power line, radar emitter, motor, transformer, or magnet
- expose the product to prolonged contact with rubber or vinyl or with volatile chemicals such as pesticides

●**Water and Sand**

Exposure to water and sand can also damage the product and its internal circuitry and mechanisms. When using the product at the beach or seaside, avoid exposing the product to water or sand. Do not place the product on a wet surface.

●**Condensation**
Sudden increases in temperature, such as occur when entering a heated building on a cold day, can cause condensation inside the product. If this occurs, turn the product off and wait for droplets to evaporate.

●**Keep hair and other objects away from product when the fan is operation. Failure to observe this precaution could result in objects becoming caught in the fan.**

●**Because the LCD monitor must kept in the open position while the fan is attached, you will need to be particularly careful not to drop the camera or otherwise subject the LCD monitor to excessive force or physical shocks.**

●**Obstructions in the vicinity of the fan's exhaust vent will interfere with cooling.**

●**The temperature of the camera may increase depending on the ambient temperature and length of use. The camera may become particularly hot when the fan is removed; due caution is advised.**

●**Be careful not to touch the product's connectors. Replace the connector cover to protect the connectors during transport.**

Attachment

For more information, see the section on cooling fans in the camera *Owner's Manual* available from the Fujifilm website.

- Turn the camera off before attaching or removing the fan. Failure to observe this precaution could result in electric shock or damage to the product.
- Be sure the product is securely attached. Failure to adequately tighten the locking screw could create a gap between the fan and the camera that could interfere with cooling. Be sure to tighten the screw if it loosens during use.
- Be sure to attach the cooling fan connector cover to the camera when the product is removed.

SPECIFICATIONS

Dimensions (W × H × D)	79.5 mm × 54.2 mm × 24.3 mm/3.13 in. × 2.13 in. × 0.96 in., excluding projections
Weight	Approx. 104 g/3.7 oz.
Operating conditions	• Temperature: −10 °C to +40 °C/+14 °F to +104 °F <ul style="list-style-type: none">Humidity: 10% to 80% (no condensation)

* These specifications are subject to change without notice. Fujifilm shall not be held liable for damages resulting from errors in this *Owner's Manual*.

FR FRANÇAIS

Merci d'avoir acheté ce produit Fujifilm. Il s'agit d'un ventilateur pour appareil photo qui peut être installé sur ce dernier afin de refroidir l'air. Pour tous travaux d'inspection, d'entretien et de réparation, consultez le revendeur d'origine ou apportez le flash à un centre de réparation Fujifilm.

Pour accéder à la liste des appareils photo compatibles, rendez-vous sur :
https://fujifilm-x.com/support/compatibility/accessories/
Lorsque vous utilisez ce produit, reportez-vous à la fois à ce guide et au chapitre sur les ventilateurs du *Manuel du propriétaire* de l'appareil photo, disponible sur le site Internet ci-dessous.
https://fujifilm-x.com/support/manual/cameras/

À l'attention des clients résidant aux États-Unis

FC

Réglementation de la FCC :

Cet appareil est conforme à la partie 15 de la réglementation de la FCC. Le fonctionnement est soumis aux deux conditions suivantes : (1) Cet appareil ne doit pas causer d'interférence nuisible et (2) Cet appareil doit accepter toute interférence reçue, y compris celle susceptible de provoquer un fonctionnement indésirable.

Cet appareil a été testé et déclaré conforme aux normes d'un appareil numérique de classe B, stipulées dans la partie 15 de la réglementation de la FCC. Ces normes sont destinées à assurer une protection suffisante contre les interférences dangereuses dans le cadre d'une installation résidentielle. Cet appareil génère, utilise et peut émettre des fréquences radio et peut, s'il n'est pas installé et utilisé conformément aux instructions, être à l'origine d'interférences dans les communications radio. Néanmoins, il n'est pas garanti que des interférences ne seront pas provoquées dans certaines installations particulières. Si cet appareil est effectivement à l'origine d'interférences nuisibles à la réception radio ou télévisuelle, ce qui peut être déterminé en éteignant et en allumant l'appareil, il est conseillé à l'utilisateur d'éviter les interférences en recourant à une ou plusieurs des mesures suivantes :

- Reorienter ou repositionner l'antenne de réception.
- Eloigner l'appareil du récepteur.
- Brancher l'appareil dans une prise appartenant à un circuit différent de celui sur lequel le récepteur est branché.
- Consulter le revendeur ou un technicien radio/télé qualifié pour obtenir de l'aide.

Tout changement ou modification apporté à l'appareil non approuvé expressément dans ce manuel pourrait annuler votre garantie.

À l'attention des clients résidant au Canada

ATTENTION :
CANICES-3(B)/NMB-3(B)
Cet appareil numérique de la classe B respecte toutes les exigences du Règlement sur le matériel brouilleur du Canada.

Élimination du matériel électrique et électronique chez les particuliers

Applicable à l'Union européenne, la Norvège, l'Islande et le Liechtenstein : Ce symbole sur le produit, ou dans le manuel et sur la garantie, et/ou sur son emballage, indique que l'appareil ne doit pas être traité comme un déchet ménager. Il doit être acheminé vers un point de collecte qui recycle le matériel électrique et électronique.

En vous assurant de la bonne élimination de ce produit, vous contribuerez à éviter des conséquences préjudiciables pour l'environnement et la santé de l'homme, qui peuvent être provoquées par l'élimination inappropriée de ce produit.

Déclaration de conformité de la CE



Nous
Nom: FUJIFILM Europe GmbH
Adresse : Heesenstrasse 31, 40549 Dusseldorf, Allemagne

déclarons que le produit
Nom du fabricant: FUJIFILM Corporation
Adresse du fabricant: 7-3, AKASAKA 9-CHOME, MINATO-KU, TOKYO, 107-0052 JAPON
selon les dispositions de la Directive CE (compatibilité électromagnétique) (2014/30/EU) et de la Directive Basse tension (2014/35/EU).

CE

AVERTISSEMENTS ET PRÉCAUTIONS (À OBSERVER)

- Afin d'utiliser ce produit correctement, lisez attentivement les instructions de fonctionnement de ce *Manuel du propriétaire*, en particulier les avertissements et les mises en garde, ainsi que les instructions de fonctionnement du *Manuel du propriétaire* de l'appareil photo (disponible sur le site Internet de Fujifilm).
- Après avoir lu ce manuel, le conserver dans un endroit sûr où il pourra facilement être consulté.
- Afin d'utiliser ce produit correctement et en toute sécurité, de ne pas vous mettre en danger et de ne pas mettre en danger d'autres personnes ou de ne pas provoquer de dommages matériels, diverses icônes sont utilisées dans ce *Manuel du propriétaire* et sur le produit. Ces icônes et leur signification sont indiquées ici. Lisez attentivement les explications et veillez à bien comprendre leur signification avant de lire le texte principal de ce manuel.

 AVERTISSEMENT	 ATTENTION
Cette icône indique un cas pouvant entraîner de graves blessures voire la mort de personnes qui ne respecteraient pas ces consignes et qui manipuleraient le produit incorrectement.	Cette icône indique un cas pouvant blesser des personnes ou endommager des objets en cas de non respect de ces consignes et de manipulation incorrecte du produit.
Exemple d'icônes	

