

User Guide

Kasa Smart Wi-Fi Light Switch, Single Pole
KS205

Contents

About This Guide	1
Introduction	2
Appearance	3
Wire Your Smart Switch	4
Set Up Your Smart Switch via Kasa	7
Set Up Your Smart Device via Matter	8
Authentication	11

About This Guide

This guide provides a brief introduction to Kasa Smart Wi-Fi Light Switch and regulatory information.

Features available in Kasa Smart may vary by model. All images, steps, and descriptions in this guide are only examples and may not reflect your actual Kasa Smart experience.

Conventions

In this guide, the following convention is used:

Convention	Description
Teal	Key information appears in teal, including management page text such as menus, items, buttons and so on.
<u>Underline</u>	Hyperlinks are in teal and underlined. You can click to redirect to a website.

More Info

- Specifications can be found on the product page at <https://www.tp-link.com>.
- Our Technical Support and troubleshooting information can be found at <https://www.tp-link.com/support>.
- A Technical Community is provided for you to discuss our products at <https://community.tp-link.com>.
- Setup Video can be found at <https://www.tp-link.com/support/setup-video/>.

Introduction

TP-Link Smart Wi-Fi Light Switch is a standard, single-pole, wall light switch that can be controlled via your iOS or Android devices. Control your home lighting or ceiling fans on your phone from anywhere, anytime with the Kasa Smart app. Turn fixtures on and off, set schedules, even group them with other Kasa Smart devices. The Kasa Smart app provides easy step-by-step installation instructions and convenient remote control from anywhere.



- **Matter-certified** - Integrate Matter-certified Kasa devices with other certified products into any Matter-certified ecosystem.
- **Control From Anywhere** - Control anything connected to your smart light switch, like lights, ceiling fans or other fixtures, from anywhere using the Kasa Smart app.
- **Voice Control** - With any Alexa, Siri or Google Assistant you can control any fixture connected to your Kasa Smart light switch with simple voice commands.
- **Grouping** - Use Grouping to combine your light switch with other Kasa Smart devices for seamless control with one single tap on your smartphone.
- **Away Mode** - Set your smart light switch to turn connected fixtures on and off at random intervals to make it appear as if you're home even while you're away.
- **Easy Installation** - No need to understand complex wiring, just follow the step-by-step wiring process in the Kasa Smart app for a guided installation of your smart light switch.
- **No Hub Required** - The Kasa Smart Wi-Fi Light Switch connects to your home's secure Wi-Fi network. No need for a hub or extra equipment.

Appearance

The Smart Switch is compatible with incandescent, LED, Halogen, and compact fluorescent light bulbs. The switch also includes a white backlight LED indicator to easily locate the switch at night. See the explanation below:

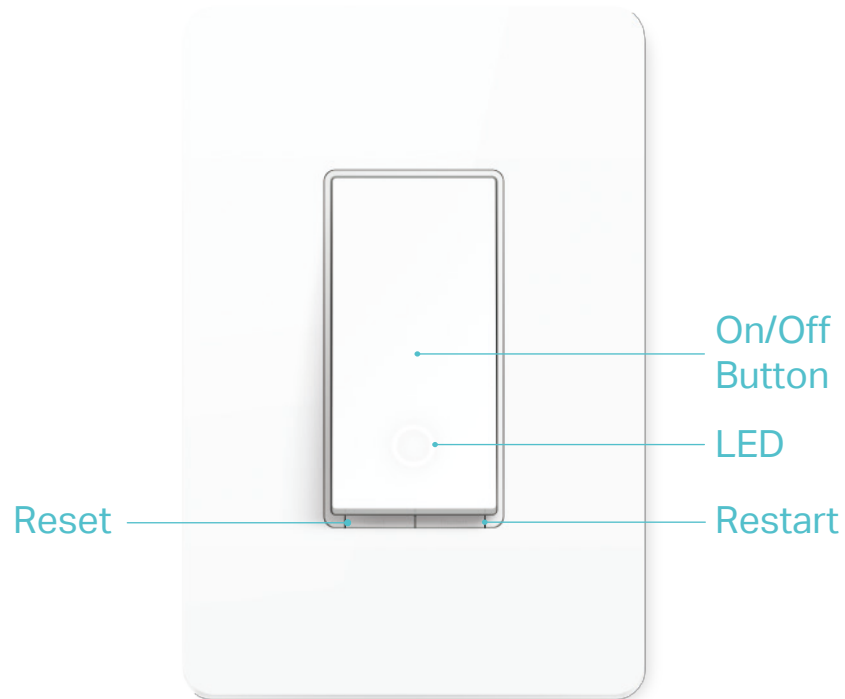

Button Explanations

Reset	Press and hold for about 5s to reset Wi-Fi while keeping other settings. Press and hold for about 10s to restore your switch to factory default settings.
Restart	Press to restart your switch.

LED Status

Solid amber	Starting up.
Blinking amber & green	Ready for setup.
Blinking green	Connecting to Wi-Fi.
Stay green for 30s	Connected to Wi-Fi.
Solid red	Disconnected from Wi-Fi.
Blinking amber	Device resetting.
White	Light fixture is off.

Wire Your Smart Switch

Follow the steps below to wire your Smart Wi-Fi Light Switch. If you are not familiar with basic electrical wiring, please consult an electrician.

Before You Start

1. Prepare Basic knowledge of Wiring

- **Ground:** Usually green or copper.
- **Neutral:** Usually white, not connected to the dumb switch.
- **Line:** Usually black, and connected to the dumb switch.
- **Load:** Usually black, and connected to the dumb switch.

Note: If you are unsure, consult a qualified electrician.

2. Prepare Your Tools

Prepare a philips and slotted screwdriver, pliers, wire strippers and a voltage detector.

3. Check Wi-Fi Strength

Make sure your switch is in a area with strong Wi-Fi signal.

Wire Your Smart Switch

Step 1. Turn Off Power and Remove the Wallplate

Turn off the circuit breaker. Then remove the old wallplate of the wall switch and label the wires.

CAUTION
Risk of Electric Shocks - High Voltage - Disconnect power supply at the circuit breaker before servicing.

MISE EN GARDE
Risque d'électrocution - Haute tension: débranchez l'alimentation électrique au niveau du disjoncteur avant l'utiliser.

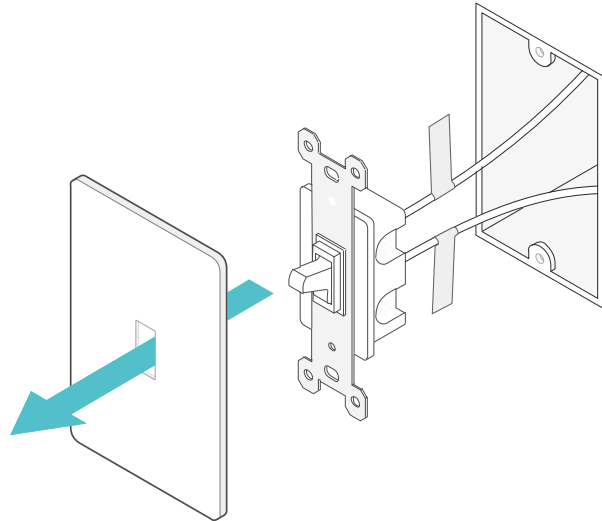

Step 2. Disconnect wires from the old switch

Gently pull the switch out and disconnect wires from the old switch.

Step 3. Connect the Wires

Use the labels and wire nuts to connect the wires to the smart switch as shown below. You can distinguish **Ground** and **Neutral** lines by their colors.

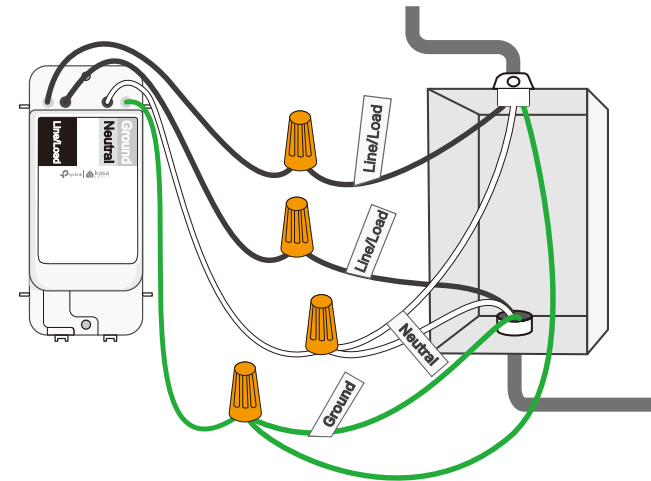

Note: No need to distinguish between Line and Load wires.

Step 4. Install Your Smart Switch

Gently fold all of the wires back into the wall box. Line up the switch with the mounting holes. Secure it with screws.

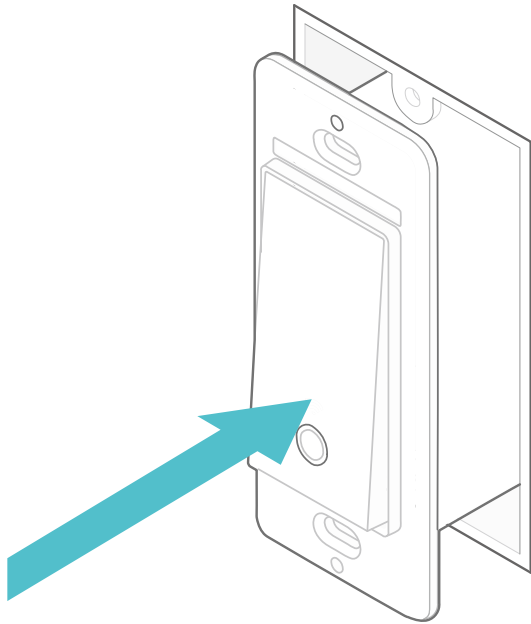

Step 5. Attach the Wallplate and Turn on Power

Attach the wallplate and turn on the circuit breaker. Then the wiring is finished.

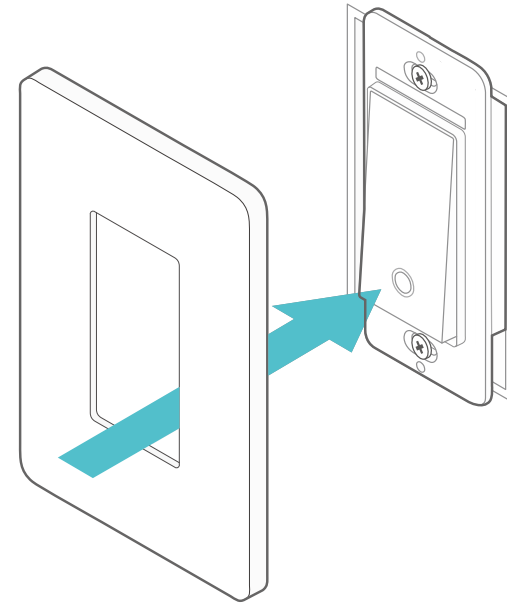

Set Up Your Smart Switch via Kasa

Follow the steps below to set up your Smart Light Switch via [Kasa Smart](#) app.

1. Download and install Kasa app

Go to Google Play or the App Store or scan the QR code below to download the **Kasa Smart** app on your Android or iOS smartphone or tablet.



OR



2. Log in or sign up with TP-Link ID

Open the app. Use your TP-Link ID to log in.

If you don't have a TP-Link ID, tap [Create Account](#) and the Kasa Smart app will guide you through the rest.

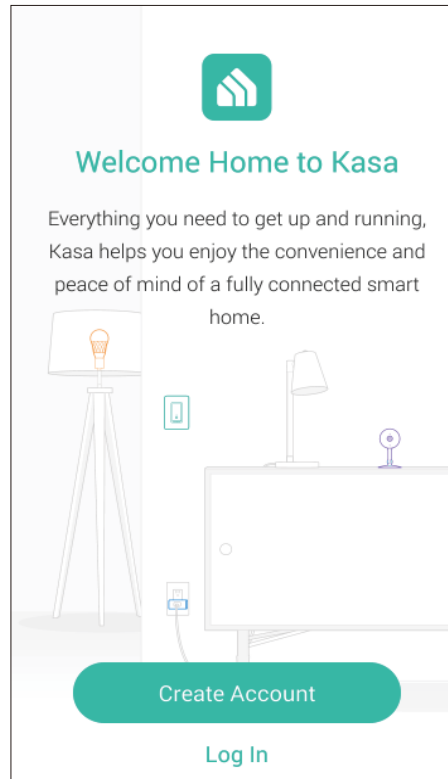

3. Add Device

Tap the + button in the Kasa Smart app, select [Smart Switch](#) > [Matter Smart Switch](#), and then follow step-by-step app instructions to complete the installation and setup.

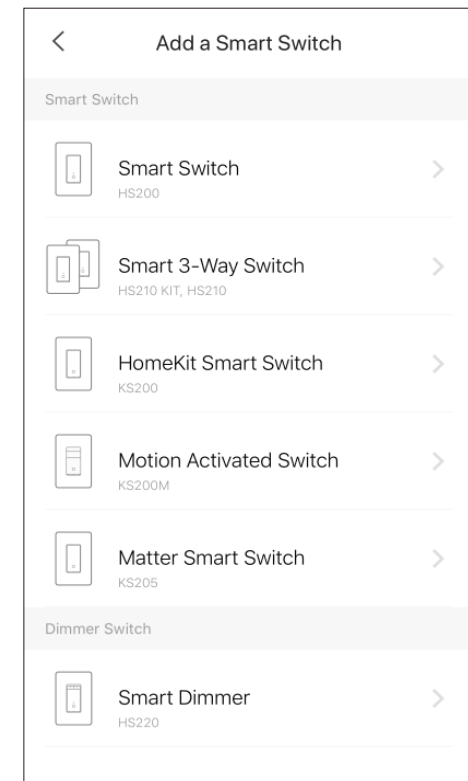

Set Up Your Smart Device via Matter

This is a Matter-certified device. You can integrate it into any Matter ecosystem you prefer for easy control, such as Alexa, Google, and Apple ecosystems. As IoT manufacturers are working to optimize the user experience of Matter setup, the setup process and user experience should improve over time. Follow the instructions below to set up your smart device via the Matter app.

Before You Start

- **Get a Matter Controller:** This is needed to connect and manage Matter devices on your home network. For instance, Apple TV and HomePod are examples of Matter controllers.
For details, please refer to the Part 3. General Questions for TP-Link Matter-enabled Devices at <https://www.tp-link.com/support/faq/3520/>.
- **Reset Your Device:** It's important to start with a fresh device. Here's how:
 - For most devices: Press and hold the 'Reset' button for 10 seconds.
 - For smart bulbs: Turn the light switch off and on five times, with a 2-second pause between each action.
- **Connect to Wi-Fi:** Connect your phone to the same Wi-Fi network as your Matter controller. Choose the 2.4 GHz network if 2.4 GHz and 5 GHz networks are separate.
- **Access Matter Setup Mode:** This mode turns off in 15 minutes after the device is powered up. To return to setup, simply turn your device off and then back on.
- **Locate Matter Setup Code:** Look for a QR code or a numeric code on your device or in its packaging. Snap a picture of it for future reference.
- **Regarding the Matter Code:** The original Matter code can only be used for setup in one app (you can reuse it after a device reset). If you wish to set it up in multiple apps, generate a new code using the first app for all subsequent ones.

How to Set Up

*Setup processes may vary between different apps.

1. Turn on Bluetooth on your phone.
2. Open the smart home app, and either scan the Matter QR code or input the given numeric code.
3. Connect your device to the same network as your controller.
4. Follow the instructions in the app to complete setup.

Failed to Set Up?

Refer to the following and you can resolve most setup issues.

1. **Update Firmware:** Make sure the firmware of your Matter hub and Smart Home app is updated to support Matter.
2. **Restart:** Try turning off and then turning back on your device and the controller. Restart your smartphone and clear the cache of the smart home app.
3. **Check IPv6:** Ensure that IPv6 is activated on your router. Visit our FAQ for step-by-step guidance at <https://www.tp-link.com/support/faq/1525/>.
4. **Enable Setup Mode:** Restart your device to re-enter setup mode since Bluetooth should be turned off in 15 minutes after the device is powered up.
5. **Regarding the Matter Code:** The original Matter code can only be used for setup in one app (you can reuse it after a device reset). If you wish to set it up in multiple apps, generate a new code using the first app for all subsequent ones.
6. **Stay on the Code-Generating Page:** Do not close the pairing code-generating page in the multi-admin setup. Otherwise, this may lead to exiting the setup mode. If you accidentally close the page after generating the pairing code before adding the device to another ecosystem, you can try to reopen it. If the reopening fails, it is recommended to restart the device and try to generate the pairing code again.
7. **Factory Reset Your Device:** Try to factory reset the device. For most devices: Press and hold the 'Reset' button for 10 seconds. For smart bulbs: Turn the light switch off and on five times, with a 1-second pause between each action.
8. If the Matter-enabled device has already been added to another ecosystem, you will need to get a new setup code for pairing according to FAQ [how to integrate your device into another ecosystem](#).

If the above steps did not help solve your problem, it's recommended that you try to factory reset the Matter-enabled device or use another smartphone to configure it.

More Information of Matter

- For matter setup guides for Alexa, Google and Apple, please refer to <https://www.tp-link.com/support/faq/3564/>
- For Matter setup troubleshooting, please refer to <https://www.tp-link.com/support/faq/3574/>
- For general questions and troubleshooting about Matter, please refer to <https://www.tp-link.com/support/faq/3520/>
- For the third-party setup video, please visit https://youtu.be/JS_7KmENSbo
- For Matter multi-admin setup and demo video, please visit <https://youtu.be/C3t4kgIK6tc>



The development of Matter is ongoing, with progress varying across platforms. Device performance and bugs can occur unrelated to the device itself. TP-Link, along with other CSA members, is committed to enhancing user experiences and service quality.



Our expert Technical Support team is ready to assist you. Please don't hesitate to reach out with any questions. Your feedback is vital to us!



EMAIL

support.usa@tp-link.com



CALL

+1 866 225 8139 (Toll Free)



CHAT

<https://livechat.tp-link.com/us/smart/>



Authentication

FCC Compliance Information Statement



Product Name: Kasa Smart Wi-Fi Light Switch, Single Pole

Model Number: KS205

Responsible party:

TP-Link USA Corporation

Address: 10 Mauchly, Irvine, CA 92618

Website: <http://www.tp-link.com/us/>

Tel: +1 626 333 0234

Fax: +1 909 527 6804

E-mail: sales.usa@tp-link.com

This equipment has been tested and found to comply with the limits for a Class B digital device, pursuant to part 15 of the FCC Rules. These limits are designed to provide reasonable protection against harmful interference in a residential installation. This equipment generates, uses and can radiate radio frequency energy and, if not installed and used in accordance with the instructions, may cause harmful interference to radio communications. However, there is no guarantee that interference will not occur in a particular installation. If this equipment does cause harmful interference to radio or television reception, which can be determined by turning the equipment off and on, the user is encouraged to try to correct the interference by one or more of the following measures:

- Reorient or relocate the receiving antenna.
- Increase the separation between the equipment and receiver.
- Connect the equipment into an outlet on a circuit different from that to which the receiver is connected.
- Consult the dealer or an experienced radio/ TV technician for help.

This device complies with part 15 of the FCC Rules. Operation is subject to the following two conditions:

1. This device may not cause harmful interference.
2. This device must accept any interference received, including interference that may cause undesired operation.

Any changes or modifications not expressly approved by the party responsible for compliance could void the user's authority to operate the equipment.

Note: The manufacturer is not responsible for any radio or TV interference caused by unauthorized modifications to this equipment. Such modifications could void the user's authority to operate the equipment.

FCC RF Radiation Exposure Statement

This equipment complies with FCC RF radiation exposure limits set forth for an uncontrolled environment. This device and its antenna must not be co-located or operating in conjunction with any other antenna or transmitter.

"To comply with FCC RF exposure compliance requirements, this grant is applicable to only Mobile Configurations. The antennas used for this transmitter must be installed to provide a separation distance of at least 20 cm from all persons and must not be co-located or operating in conjunction with any other antenna or transmitter."

We, **TP-Link USA Corporation**, has determined that the equipment shown as above has been shown to comply with the applicable technical standards, FCC part 15. There is no unauthorized change is made in the equipment and the equipment is properly maintained and operated.

Issue Date: 2023-07-25

Canadian Compliance Statement

This device contains licence-exempt transmitter(s)/receiver(s) that comply with Innovation, Science and Economic Development Canada's licence-exempt RSS(s). Operation is subject to the following two conditions:

- (1) This device may not cause interference.
- (2) This device must accept any interference, including interference that may cause undesired operation of the device.

L'émetteur/récepteur exempt de licence contenu dans le présent appareil est conforme aux CNR d'Innovation, Sciences et Développement économique Canada applicables aux appareils radio exempts de licence. L'exploitation est autorisée aux deux conditions suivantes :

- 1) L'appareil ne doit pas produire de brouillage;
- 2) L'appareil doit accepter tout brouillage radioélectrique subi, même si le brouillage est susceptible d'en compromettre le fonctionnement.

Radiation Exposure Statement:

This equipment complies with IC radiation exposure limits set forth for an uncontrolled environment. This equipment should be installed and operated with minimum distance 20cm between the radiator & your body.

Déclaration d'exposition aux radiations:

Cet équipement est conforme aux limites d'exposition aux rayonnements IC établies pour un environnement non contrôlé. Cet équipement doit être installé et utilisé avec un minimum de 20 cm de distance entre la source de rayonnement et votre corps

Industry Canada Statement

CAN ICES-3 (B)/NMB-3(B)

Safety Information



Before installing, servicing or removing the switch, read and follow all safety precautions including the following:

- Follow all national and local safety regulations and practices. If you are uncertain or uncomfortable when performing the installation, consult a qualified electrician.
- CAUTION – Risk of Electric Shock – More than one disconnect switch may be required to de-energize the equipment and luminaire before servicing. A circuit breaker which disconnects the Line and Neutral conductor simultaneously is suitable.
- CAUTION – High Voltage – Disconnect power supply before servicing. Ensure power is off at the circuit breaker before removing or installing any switch. Use a non-contact voltage tester to ensure the power is off.
- Do not install the Smart Switch with wet hands or when standing on wet or damp surfaces.

- Keep the device away from water, fire, humidity or hot environments.
- Do not attempt to disassemble, repair, or modify the device. If you need service, please contact us.
- Do not use the device where wireless devices are not allowed.
- Rating: 100-120 V~ 50/60 Hz
- Supported Load: 15 A General Use, 600 W Incandescent, 120 W Max Ceiling Fan, 1/6 HP Motor.
- Operation temperature: 0~40°C (32~104°F)
- Install only in a suitable UL Listed outlet box (suitable dimensions: H > 2.95 in./75 mm, W > 1.81 in./46 mm, D > 2 in./51 mm).

	CAUTION
Electrical switch integrated in this product is only intended for functional purposes. De-energized the product at the circuit breaker before servicing.	

Explanation of the symbols on the product label

Symbol	Explanation
	Alternating current
	Indoor use only
	<p>RECYCLING</p> <p>This product bears the selective sorting symbol for Waste electrical and electronic equipment (WEEE). This means that this product must be handled pursuant to European directive 2012/19/EU in order to be recycled or dismantled to minimize its impact on the environment.</p> <p>User has the choice to give his product to a competent recycling organization or to the retailer when he buys a new electrical or electronic equipment.</p>