

Stereo Line Out 1U System

Stereo Balanced Line Audio Output



+

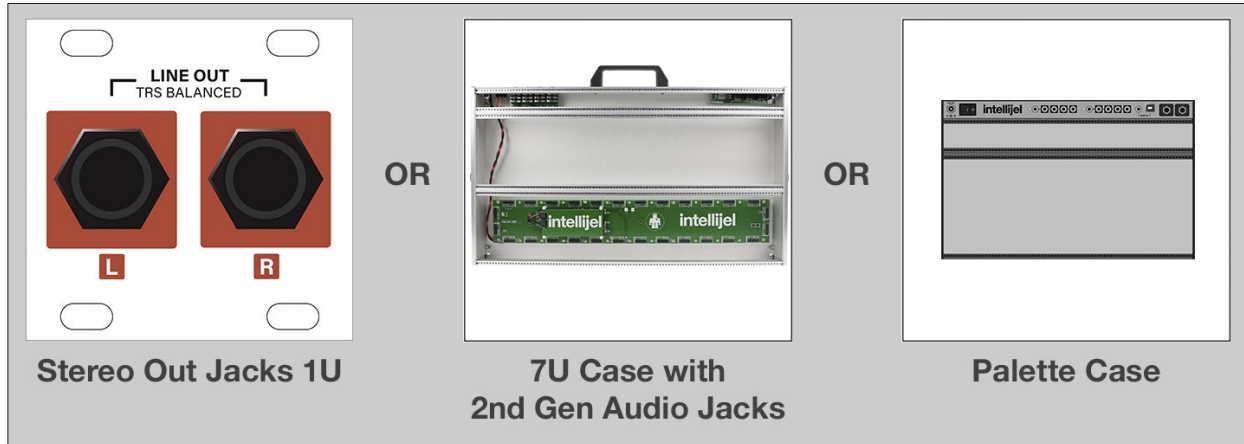

TABLE OF CONTENTS

COMPLIANCE	2
SYSTEM OVERVIEW	2
INSTALLATION	4
Before You Start	4
Installing Your Module	5
Connecting a Stereo Line Out 1U to a Stereo Out Jacks 1U	7
Connecting a Stereo Line Out 1U to the ¼” Jacks on a 7U Case	8
Connecting Two Stereo Line Out 1U’s to the ¼” Jacks on a 7U Case	9
Connecting a Stereo Line Out 1U to a Palette Case’s ¼” Jacks	10
Using The 3-Pin Link Connector	11
Connecting Stereo Line Out 1U to a v2 Headphones 1U Module	11
FRONT PANEL (Stereo Line Out 1U)	13
Controls	13
Inputs & Outputs	14
FRONT PANEL (Stereo Out Jacks 1U)	15
Inputs & Outputs	15
TECHNICAL SPECIFICATIONS	16
Stereo Line Out 1U	16
Stereo Out Jacks	16



COMPLIANCE



This device complies with Part 15 of the FCC Rules. Operation is subject to the following two conditions: (1) this device may not cause harmful interference, and (2) this device must accept any interference received, including interference that may cause undesired operation.

Changes or modifications not expressly approved by Intellijel Designs, Inc. could void the user's authority to operate the equipment.

Any digital equipment has been tested and found to comply with the limits for a Class A digital device, pursuant to part 15 of the FCC Rules. These limits are designed to provide reasonable protection against harmful interference when the equipment is operated in a commercial environment. This equipment generates, uses, and can radiate radio frequency energy and, if not installed and used in accordance with the instruction manual, may cause harmful interference to radio communications.



This device meets the requirements of the following standards and directives:

EMC: 2014/30/EU
EN55032:2015 ; EN55103-2:2009 (EN55024) ; EN61000-3-2 ;
EN61000-3-3

Low Voltage: 2014/35/EU
EN 60065:2002+A1:2006+A11:2008+A2:2010+A12:2011

RoHS2: 2011/65/EU

WEEE: 2012/19/EU

SYSTEM OVERVIEW

Use the Stereo Line Out 1U system to send audio from your modular synth into power amplifiers, mixers, audio interfaces, DAWs, and other such audio gear. The system works with both balanced +4 dBu professional audio products; and with -10dBV unbalanced gear.

The Stereo Line Out 1U system comprises two components:

[1] The **Stereo Line Out 1U** module:

	<p>This module has 1/8" jacks to accept either mono or stereo audio signals from your modular gear. It features input level indicator LEDs, and contains all the gain control circuitry necessary to drive external audio gear at the proper levels.</p> <p>A ribbon cable is included for connecting it to either the Stereo Out Jacks 1U module, or a compatible Intellijel case with 1/4" jacks.</p>
--	--

[2] Either a **Stereo Out Jacks 1U** module, or a case with built-in 1/4" audio jacks, such as Intellijel's **Palette** or **7U cases** (with a 2nd generation **Audio Jacks board**):

	<p>Stereo Out Jacks 1U Module</p> <p>If you don't own an Intellijel case with built-in compatible 1/4" jacks, then you need to purchase a Stereo Out Jacks 1U module, which connects via ribbon cable to the Stereo Line Out 1U module to provide 1/4" TRS output jacks for interfacing with other studio or stage gear.</p>
	<p>Palette Case</p> <p>If you own an Intellijel Palette case, you can connect the Stereo Line Out 1U module directly to a built-in pair of 1/4" jacks, rather than purchasing a Stereo Out Jacks 1U.</p>
	<p>7U Case w/ 2nd Generation Audio Jacks Board</p> <p>If you own an Intellijel 7U case with a 2nd generation Audio Jacks Board (distinguished by the row of shrouded headers along its bottom edge), you can use its jacks rather than purchasing a Stereo Out Jack 1U module.</p> <p>If your 7U case has a 1st generation Audio Jacks Board, you can purchase a 2nd generation board to replace your old board.</p>

INSTALLATION

This module is designed for use within an Intellijel-standard 1U row, such as contained within the Intellijel 4U and 7U Eurorack cases. Intellijel's 1U specification is derived from the Eurorack mechanical specification set by Doepfer that is designed to support the use of lipped rails within industry standard rack heights.

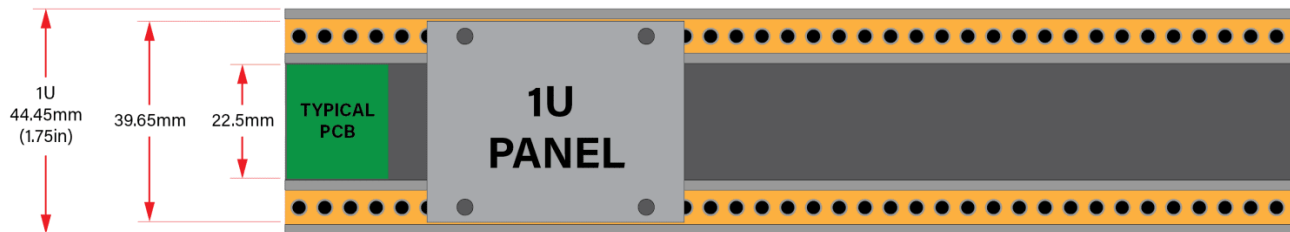
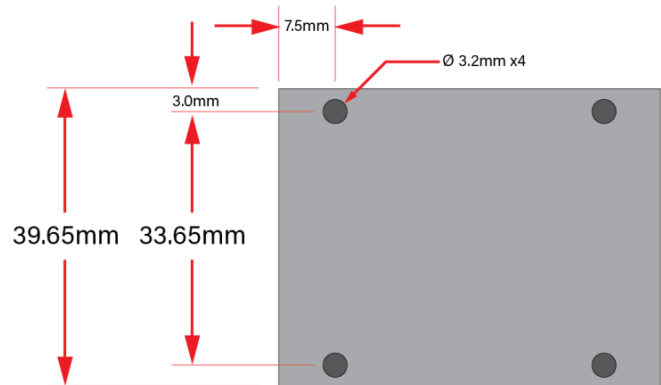

Before You Start

Intellijel Eurorack modules are designed to be used with a Eurorack-compatible case and power supply. We recommend you use Intellijel cases and power supplies.

Before installing a new module in your case, you must ensure your power supply has a free power header and sufficient available capacity to power the module:

- Sum up the specified +12V current draw for all modules, including the new one. Do the same for the -12 V and +5V current draw. The current draw will be specified in the manufacturer's technical specifications for each module.
- Compare each of the sums to specifications for your case's power supply.
- Only proceed with installation if none of the values exceeds the power supply's specifications. Otherwise you must remove modules to free up capacity or upgrade your power supply.

You will also need to ensure your case has enough free space (hp) to fit the new module. To prevent screws or other debris from falling into the case and shorting any electrical contacts, do not leave gaps between adjacent modules, and cover all unused areas with blank panels. Similarly, do not use open frames or any other enclosure that exposes the backside of any module or the power distribution board.

You can use a tool like [ModularGrid](#) to assist in your planning. Failure to adequately power your modules may result in damage to your modules or power supply. If you are unsure, please [contact us](#) before proceeding.

Installing Your Module

When installing or removing a module from your case always turn off the power to the case and disconnect the power cable. Failure to do so may result in serious injury or equipment damage.

Ensure the 10-pin connector on the power cable is connected correctly to the module before proceeding. The red stripe on the cable must line up with the -12V pins on the module's power connector. Different modules use different ways to indicate the -12V pins. Some may be labeled with "-12V;" a white stripe next to the -12V pins; the words "red stripe;" or some combination of these. Additionally, some modules may have shrouded headers, thus preventing backward connections.

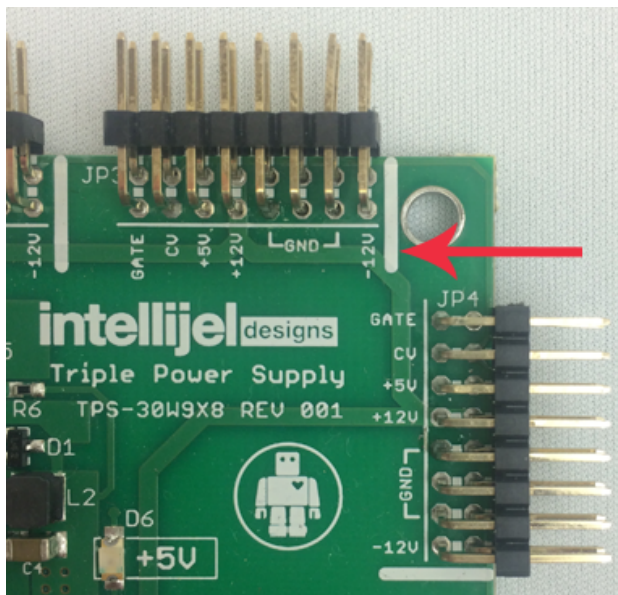
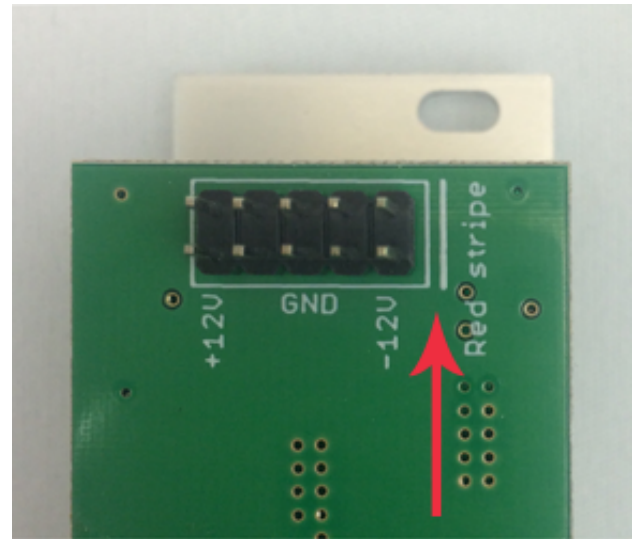

Most modules will come with the cable already connected but it is good to double check the orientation. Be aware that some modules may have headers that serve other purposes so ensure the power cable is connected to the right one.

The other end of the cable, with a 16-pin connector, connects to the power bus board of your Eurorack case. Ensure the red stripe on the cable lines up with the -12V pins on the bus board. On Intellijel power supplies the pins are labeled with the label "-12V" and a thick white stripe:

If you are using another manufacturer's power supply, check their documentation for instructions.

Once connected, the cabling between the module and power supply should resemble the picture below:

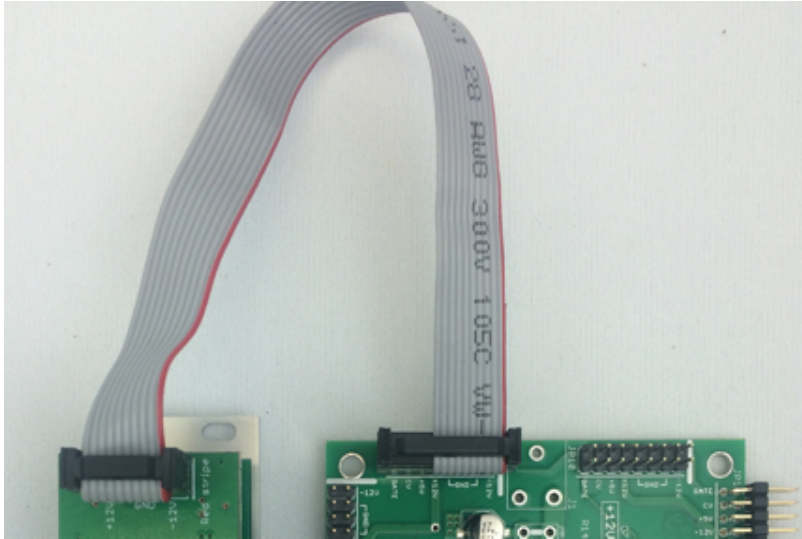

Before reconnecting power and turning on your modular system, double check that the ribbon cable is fully seated on both ends and that all the pins are correctly aligned. If the pins are misaligned in any direction or the ribbon is backwards you can cause damage to your module, power supply, or other modules.

After you have confirmed all the connections, you can reconnect the power cable and turn on your modular system. You should

immediately check that all your modules have powered on and are functioning correctly. If you notice any anomalies, turn your system off right away and check your cabling again for mistakes.

Connecting a Stereo Line Out 1U to a Stereo Out Jacks 1U

The *Stereo Line Out 1U* module ships with a ribbon cable for connecting to a pair of ¼" TRS audio jacks — either those built-in to the 2nd generation *Audio Jacks Board* installed in *Intellijel 7U* cases; an *Intellijel Palette* case, or those contained within the separately available *Stereo Out Jacks 1U* module.

To connect the *Stereo Line Out 1U* module to the *Stereo Out Jacks 1U* module:

1. Connect one end of the supplied ribbon cable to the keyed 6-pin connector on the *Stereo Line Out 1U* module and the other end to the *Stereo Out Jacks 1U*'s lone keyed 6-pin connector.

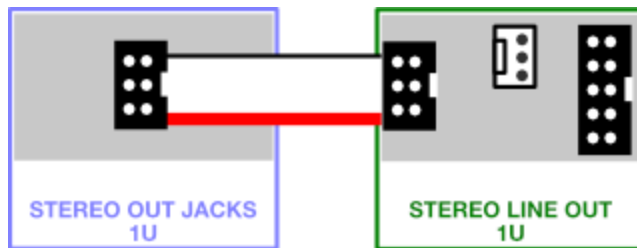

The output signal appears on the *Stereo Out Jacks*' ¼" TRS jacks.

Connecting a Stereo Line Out 1U to the ¼" Jacks on a 7U Case

The *Stereo Line Out 1U* module ships with a ribbon cable for connecting to a pair of ¼" TRS audio jacks — either those built-in to the 2nd generation *Audio Jacks Board* installed in *Intellijel 7U* cases; an *Intellijel Palette* case, or those contained within the separately available *Stereo Out Jacks 1U* module

To connect the *Stereo Line Out 1U* module to the jacks installed in your 7U case:

1. Determine whether your case uses a 1st or 2nd generation Audio Jacks Board.

1st generation boards (included with cases built before early 2019) have a single connector along the bottom. 2nd generation boards have a large shrouded header flanked by two smaller shrouded headers, flanked by two link connectors.

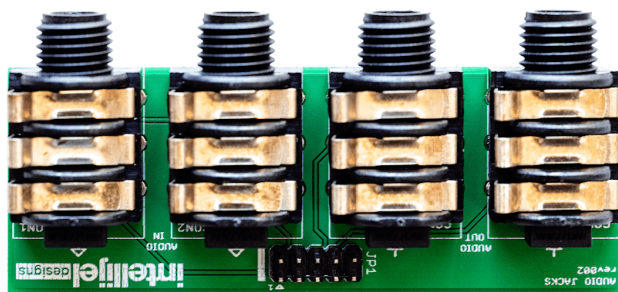

1st GENERATION AUDIO JACKS

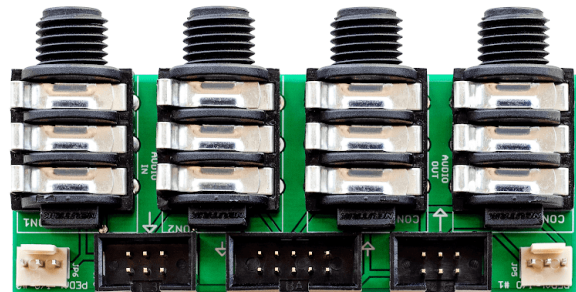

2nd GENERATION AUDIO JACKS

IMPORTANT: You can only connect the *Stereo Line Out 1U* module to 7U cases with 2nd generation Audio Jacks Boards. If you have a 1st generation board, you can purchase a 2nd generation board to replace your original Audio Jacks Board.

2. Connect one end of the supplied ribbon cable to the keyed 6-pin connector on the Stereo Line Out 1U module and the other end to one of the two keyed 6-pin connectors on the Audio Jacks Board.

The Stereo Line Out's signal appears on the corresponding pair of ¼" output jacks on the Audio Jacks Board.

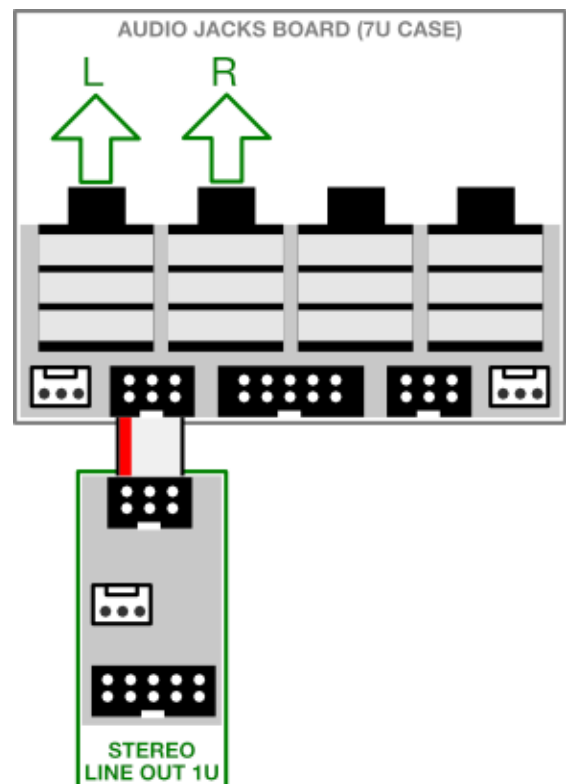

Connecting Two Stereo Line Out 1U's to the ¼" Jacks on a 7U Case

If you wish, you can connect a second Stereo Line Out 1U module to the other 6-pin connector on the Audio Jacks board, giving you four audio outputs in a 7U case.

1. Using the ribbon cable supplied with the *Stereo Line Out 1U* module, connect it to one of the two keyed 6-pin connectors on the 2nd generation Audio Jacks Board.
2. Connect the other *Stereo Line Out 1U* module to the remaining keyed 6-pin connector on the Audio Jacks board.

The output of each *Stereo Line Out 1U* module appears at the corresponding set of ¼" jacks on the Audio Jacks board.

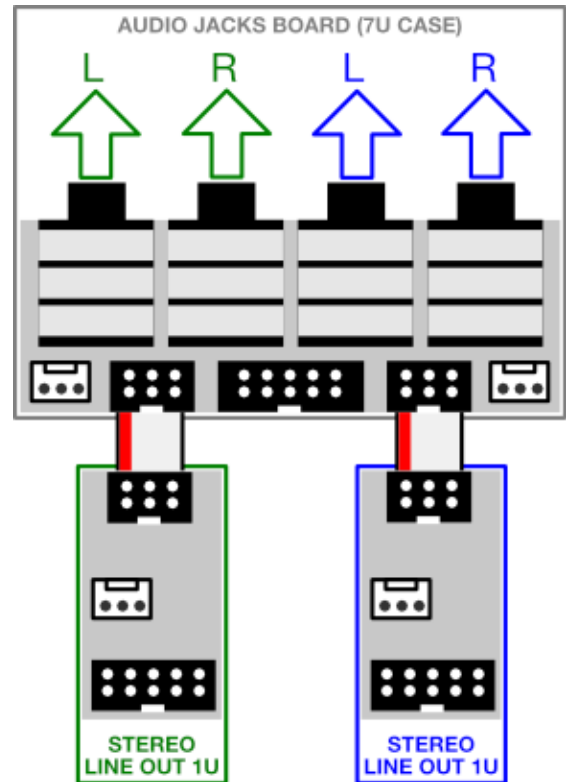

Connecting a Stereo Line Out 1U to a Palette Case's ¼" Jacks

The *Stereo Line Out 1U* module ships with a ribbon cable for connecting to a pair of ¼" TRS audio jacks — either those built-in to the 2nd generation *Audio Jacks Board* installed in *Intellijel 7U* cases; an *Intellijel Palette case*, or those contained within the separately available *Stereo Out Jacks 1U* module.

To connect the *Stereo Line Out 1U* module to the jacks installed in your *Intellijel Palette case*:

1. Connect one end of the supplied ribbon cable to the keyed 6-pin connector on the *Stereo Line Out 1U* module and the other end to the one keyed 6-pin connector on the Palette case's built-in circuit board.

The Stereo Line Out's signal appears on the Palette case's ¼" output jacks.

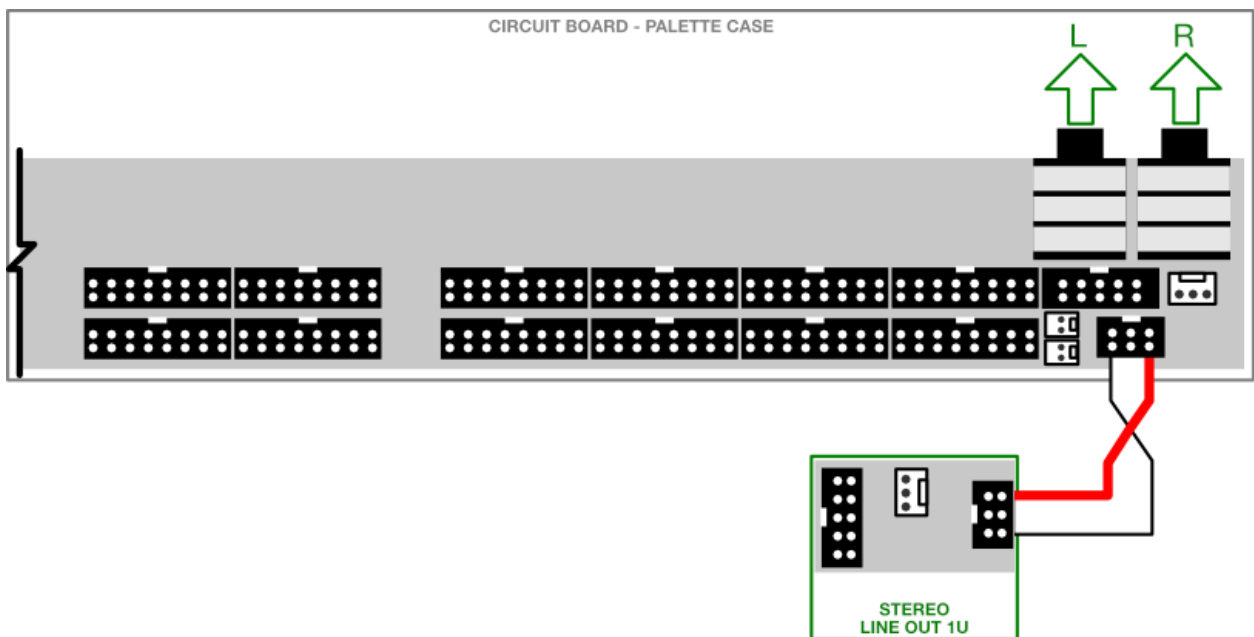
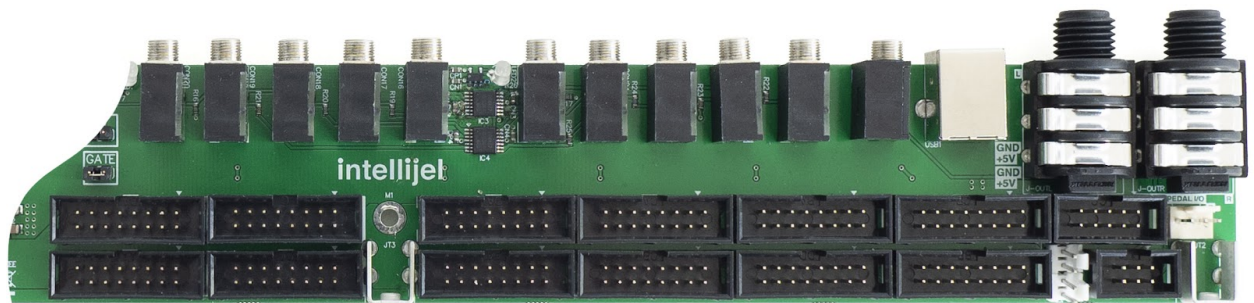

Using The 3-Pin Link Connector

Use the 3-pin *output* Link connector on the back of the Stereo Line Out 1U module to connect to the 3-pin *input* Link connector on another module, eliminating the necessity of patching them through their front panels.

*NOTE: The 3-pin Link connector on the back of the Stereo Line Out 1U module is **NOT** an input connector, and is therefore **NOT** meant for connecting to the 3-pin outputs of modules such as the Intellijel Mixup.*

Connecting Stereo Line Out 1U to a v2 Headphones 1U Module

If you own an Intellijel Headphones 1U module (version 2 only), you can connect it directly to the Stereo Line Out 1U using the included link cable. To do so:

1. Confirm you have a “version 2” Headphones 1U module.

Version 2 Headphones 1U modules, in production since August 2019, have a 3-pin Link connector and a jumper on the rear panel. Version 1 modules do not.

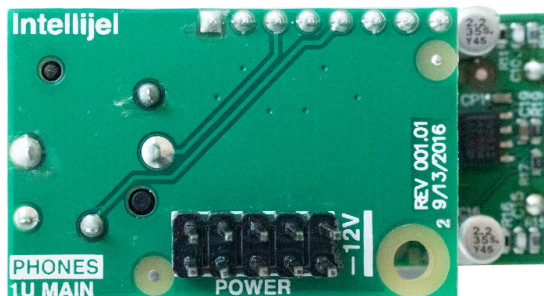

VERSION 1 variations have only a single power connector on the rear panel

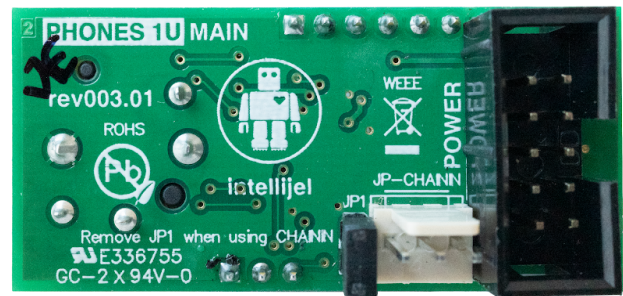

VERSION 2 has power, plus a 3-pin Link Connector (and normalizing jumper) on the rear panel

2. Using the 3-wire Link cable provided with your module, connect one end of it to the 3-pin output Link connector on the Stereo Line Out 1U module, and the other end to the 3-pin input Link connector on the Headphones 1U module.

- IMPORTANT!** On the back of the Headphones 1U module, **remove the JP1 jumper connector and put it in a safe place.**

This jumper is what normally the Headphones 1U module's Left input to its Right input. Since the Stereo Line Out 1U module has its own Left-to-Right normaling, 3-pin Link connections require removal of this jumper to achieve expected operation and optimum sonic fidelity.

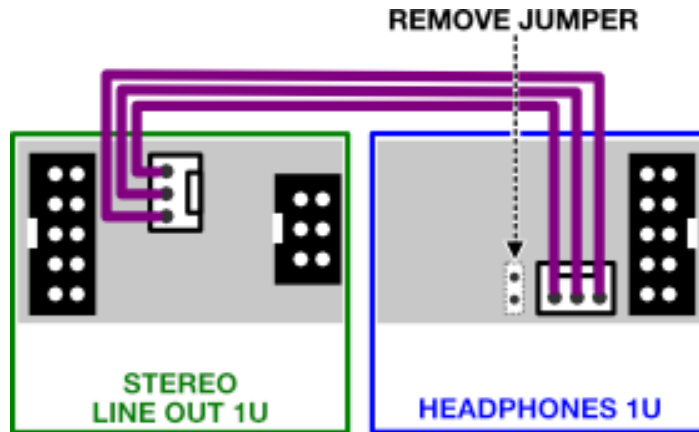

Once connected through their 3-pin Link cables, the Stereo Line Out 1U L and R outputs are sent directly to the left and right inputs on your Headphones 1U module without patching the front panels — duplicating the signal that the Stereo Line Out 1U module sends to the ¼" output jacks.

FRONT PANEL (Stereo Line Out 1U)

Controls

[A] STEREO OUT GAIN (L+R)

Adjusts the signal level being sent out whichever pair of ¼" jacks you've connected to the rear of this module (ie. a *Stereo Line Out 1U* module, a *Palette* case, or a *7U* case with 2nd generation Audio Jacks board).

When set straight up (12 o'clock position) and fed with a 1kHz, 10 V peak-to-peak sine wave, the module outputs approximately +4 dBu to the connected ¼" jacks.

Above 12:00 o'clock, the module outputs voltages in excess of +4 dBu, reaching a top-of-spec limit of +21 dBu at maximum clockwise rotation.

When set to the 10 o'clock position and fed with a 1kHz, 10 V peak-to-peak sine wave, the module sends approximately a -10dBV unbalanced level to the connected ¼" jacks.

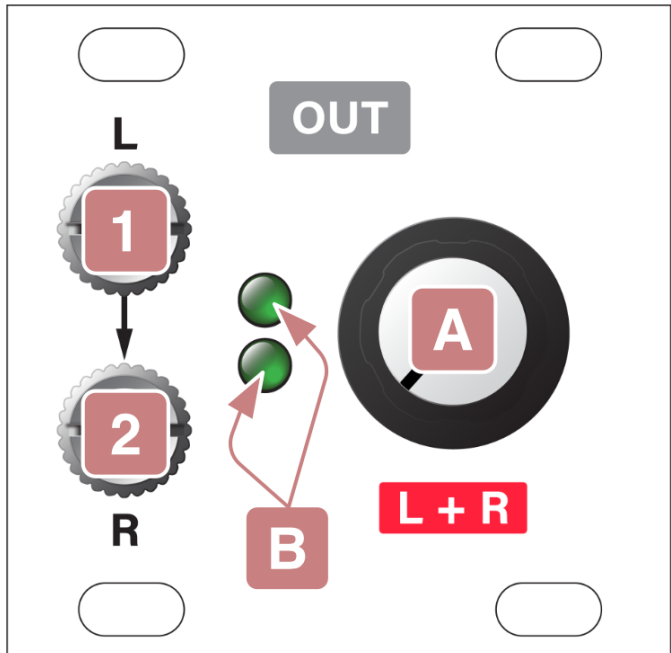

[B] INPUT ACTIVITY LEDs

These two LEDs indicate the presence of a signal at the **L Input [1]** and **R Input [2]** jacks, respectively. The LEDs first light with about 400mV of input signal, and become increasingly brighter as the input level increases.

Because the **L Input** jack is normalled to the **R Input** jack, both LEDs will light if you send a signal to only the **L Input**.

Inputs & Outputs

[1] L Input

Eurorack-level audio sent into this jack is scaled by the **Stereo Out Gain** knob [A] to support both +4 dBu or -10 dBV external audio gear, then sent to the left 1/4" output jack on whichever jacks circuit is connected to the back of the *Stereo Line Out 1U* (ie. a *Stereo Out Jacks 1U* module, a *Palette* case, or a *7U* case with 2nd generation Audio Jacks board).

[2] R Input

Eurorack-level audio sent into this jack is scaled by the **Stereo Out Gain** knob [A] to support both +4 dBu or -10 dBV external audio gear, then sent to the right 1/4" output jack on whichever jacks circuit is connected to the back of the *Stereo Line Out 1U* (ie. a *Stereo Out Jacks 1U* module, a *Palette* case, or a *7U* case with 2nd generation Audio Jacks board).

NOTE: The **L Input** jack is normalled to the **R Input** jack. If nothing is connected to the **R Input** jack, then a mono signal fed into the **L Input** jack will feed both of the 1/4" output jacks.

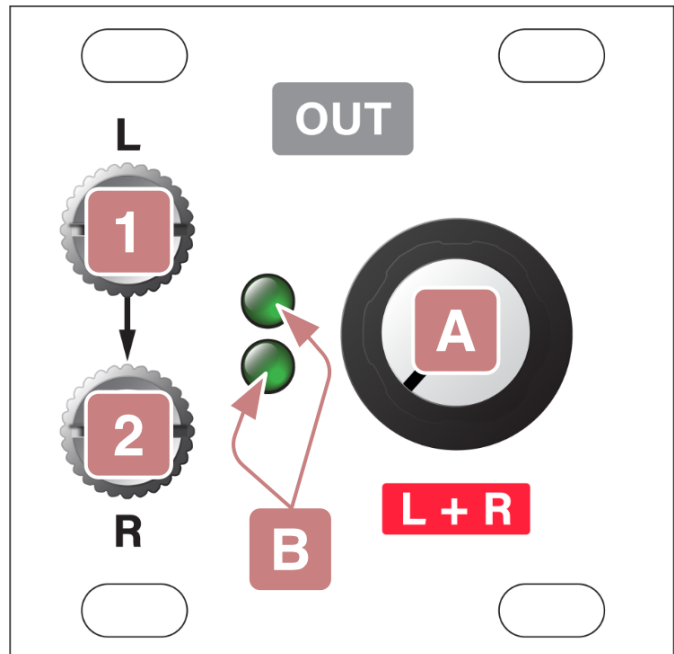

FRONT PANEL (Stereo Out Jacks 1U)

Inputs & Outputs

[1] LINE OUT (L)

The scaled output of your *Stereo Line Out 1U's 1/8" L Input* jack appears at this balanced 1/4" TRS jack for mixing with other studio-level gear, or for recording into your DAW. This output supports both professional, balanced +4 dBu equipment and prosumer, unbalanced -10 dBV level gear.

[2] LINE OUT (R)

The scaled output of your *Stereo Line Out 1U's 1/8" R Input* jack appears at this balanced 1/4" TRS jack for mixing with other studio-level gear, or for recording into your DAW. This output supports both professional, balanced +4 dBu equipment and prosumer, unbalanced -10 dBV level gear.

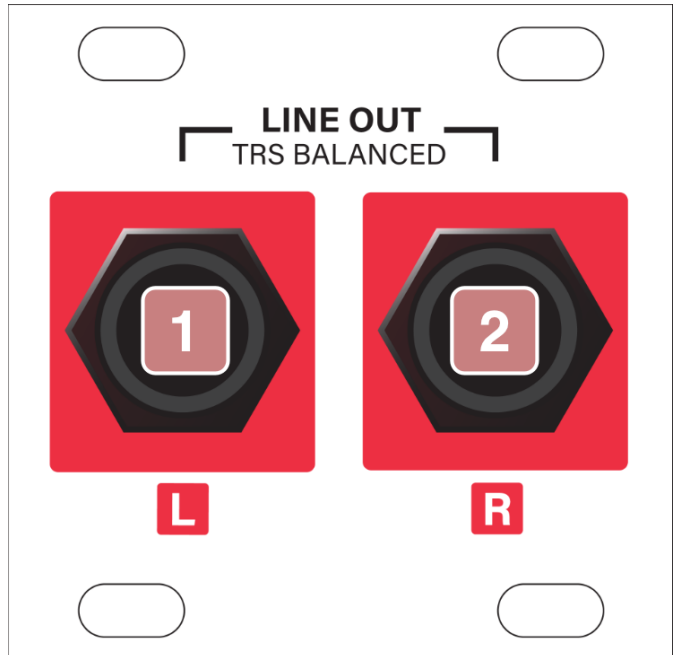

TECHNICAL SPECIFICATIONS

Stereo Line Out 1U

Width	8 hp
Maximum Depth	29 mm
Current Draw	19 mA @ +12V 12 mA @ -12V (at maximum amplification)

Stereo Out Jacks

Width	8 hp
Maximum Depth	34 mm
Current Draw	0 mA (passive module)