



**Computer Sharing Device  
CS231 / CS231TK User Manual**



## EMC Information

### FEDERAL COMMUNICATIONS COMMISSION INTERFERENCE

**STATEMENT:** This equipment has been tested and found to comply with the limits for a Class B digital service, pursuant to Part 15 of the FCC rules. These limits are designed to provide reasonable protection against harmful interference in a residential installation. Any changes or modifications made to this equipment may void the user's authority to operate this equipment. This equipment generates, uses, and can radiate radio frequency energy. If not installed and used in accordance with the instructions, may cause harmful interference to radio communications. However, there is no guarantee that interference will not occur in a particular installation. If this equipment does cause harmful interference to radio or television reception, which can be determined by turning the equipment off and on, the user is encouraged to try to correct the interference by one or more of the following measures:

- ◆ Reorient or relocate the receiving antenna.
- ◆ Increase the separation between the equipment and receiver.
- ◆ Connect the equipment into an outlet on a circuit different from that to which the receiver is connected.
- ◆ Consult the dealer or an experienced radio/TV technician for help.

**FCC Caution:** Any changes or modifications not expressly approved by the party responsible for compliance could void the user's authority to operate this equipment.

This device complies with Part 15 of the FCC Rules. Operation is subject to the following two conditions:

- (1) this device may not cause harmful interference, and
- (2) this device must accept any interference received, including interference that may cause undesired operation.

### KCC Statement

유선 제품용 / B 급 기기 (가정용 방송 통신 기기)  
이 기기는 가정용 (B 급) 전자파적합기기로서 주로 가정에서 사용하는 것을 목적으로 하며, 모든 지역에서 사용할 수 있습니다.



## **RoHS**

---

This product is RoHS compliant.

## User Information

---

### Online Registration

Be sure to register your product at our online support center:

---

International	<a href="http://eservice.aten.com">http://eservice.aten.com</a>
---------------	---

---

### Telephone Support

For telephone support, call this number:

---

International	886-2-8692-6959
China	86-400-810-0-810
Japan	81-3-5615-5811
Korea	82-2-467-6789
North America	1-888-999-ATEN ext 4988 1-949-428-1111

---

### User Notice

All information, documentation, and specifications contained in this manual are subject to change without prior notification by the manufacturer. The manufacturer makes no representations or warranties, either expressed or implied, with respect to the contents hereof and specifically disclaims any warranties as to merchantability or fitness for any particular purpose. Any of the manufacturer's software described in this manual is sold or licensed as *is*. Should the programs prove defective following their purchase, the buyer (and not the manufacturer, its distributor, or its dealer), assumes the entire cost of all necessary servicing, repair and any incidental or consequential damages resulting from any defect in the software.

The manufacturer of this system is not responsible for any radio and/or TV interference caused by unauthorized modifications to this device. It is the responsibility of the user to correct such interference.

The manufacturer is not responsible for any damage incurred in the operation of this system if the correct operational voltage setting was not selected prior to operation. PLEASE VERIFY THAT THE VOLTAGE SETTING IS CORRECT BEFORE USE.

## Package Contents

---

### CS231

- 1 CS231 Computer Sharing Device
- 1 USB KVM Cable
- 1 Power Adapter
- 1 Firmware Upgrade Cable
- 1 DIP Switch Sticker
- 1 User Instructions\*

### CS231TK

- 1 CS231 Computer Sharing Device
- 1 USB KVM Cable
- 1 Power Adapter
- 1 Firmware Upgrade Cable
- 1 DIP Switch Sticker
- 1 2XRT-0015G KVM over IP Access Control Box
- 1 User Instructions\* (2XRT-0015G KVM over IP Access Control Box only)

- 
- Note:** 1. \* Features may have been added to the KVM over IP console station since the user instructions were created. Please visit our website to download the most up-to-date version of the user manual
2. Make sure that all of the components are present and in good order. If anything is missing or was damaged in shipping, contact your dealer.
  3. Read this manual thoroughly and follow the installation and operation procedures carefully to prevent any damage to the unit, and/or any of the devices connected to it.
-

# Table of Contents

---

EMC Information . . . . .	ii
RoHS . . . . .	iii
User Information . . . . .	iv
Online Registration . . . . .	iv
Telephone Support . . . . .	iv
User Notice . . . . .	iv
Package Contents . . . . .	v
About this Manual . . . . .	viii
Conventions . . . . .	ix
Product Information . . . . .	ix
<b>1. Introduction</b>	
Overview . . . . .	1
Features . . . . .	2
CS231 / CS231TK . . . . .	2
2XRT-0015G KVM over IP Access Control Box . . . . .	2
System Requirements . . . . .	3
Operating System: . . . . .	3
Cables . . . . .	3
Components . . . . .	4
CS231 / CS231TK Front View . . . . .	4
CS231 / CS231TK Rear View . . . . .	5
2XRT-0015G KVM over IP Access Control Box Front View . . . . .	6
<b>2. Hardware Setup</b>	
Before You Begin . . . . .	7
Installation Diagram . . . . .	8
<b>3. Basic Operation</b>	
Overview . . . . .	9
2XRT-0015G KVM over IP Access Control Box . . . . .	9
LED statuses . . . . .	9
<b>4. Operation</b>	
Overview . . . . .	11
Auto Mode . . . . .	11
Timeout . . . . .	12
Private Mode (Console 1) . . . . .	12
Screen Saver . . . . .	12
DIP Switch Settings Table . . . . .	13
Manual Mode . . . . .	13
Hotkey Setting Mode . . . . .	14
HSM Summary Table . . . . .	14

Keyboard Emulation Mapping . . . . .	15
Apple Keyboard . . . . .	15

## **5. The Firmware Upgrade Utility**

Introduction . . . . .	17
Before You Begin . . . . .	17
Starting the Upgrade . . . . .	17
Upgrade Succeeded . . . . .	19
Upgrade Failed . . . . .	20

## **Appendix**

Safety Instructions . . . . .	21
General . . . . .	21
Technical Support . . . . .	23
International . . . . .	23
North America . . . . .	23
Specifications . . . . .	24
Troubleshooting . . . . .	25
Limited Warranty . . . . .	26

## About this Manual

---

This user manual is provided to help you get the most from the CS231 / CS231TK unit. It covers all aspects of installation, configuration, and operation. An overview of the information found in the manual is provided below.

**Chapter 1, Introduction**, introduces you to the CS231 / CS231TK system. Its purpose, features, and benefits are presented, and its front and back panel components are described.

**Chapter 2, Hardware Setup**, describes the steps that are necessary to quickly and safely set up your installation.

**Chapter 3, Basic Operation**, explains the fundamental concepts involved in operating the CS231 / CS231TK.

**Chapter 4, Operation**, explains the CS231 / CS231TK's operating and hotkey settings mode as well as the EDID selection feature.

**Chapter 5, The Firmware Upgrade Utility**, explains how to use this utility to upgrade the CS231 / CS231TK firmware to the latest available version.

**An Appendix**, provides a list of safety instructions and precautions, contact information for ATEN technical support, product specifications, and other technical information.

---

### Note:

- ◆ Read this manual thoroughly and follow the installation and operation procedures carefully to prevent any damage to the unit or any connected devices.
- ◆ ATEN regularly updates its product documentation for new features and fixes. For an up-to-date CS231 / CS231TK documentation, visit

<http://www.aten.com/global/en/>

---

## Conventions

---

This manual uses the following conventions:

- `Monospaced` Indicates text that you should key in.
- [ ] Indicates keys you should press. For example, [Enter] means to press the **Enter** key. If keys need to be chorded, they appear together in the same bracket with a plus sign between them: [Ctrl+Alt].
1. Numbered lists represent procedures with sequential steps.
- ◆ Bullet lists provide information, but do not involve sequential steps.
- Indicates selecting the option (on a menu or dialog box, for example), that comes next. For example, Start → Run means to open the *Start* menu, and then select *Run*.
-  Indicates critical information.

## Product Information

---

For information about all ATEN products and how they can help you connect without limits, visit ATEN on the Web or contact an ATEN Authorized Reseller. Visit ATEN on the Web for a list of locations and telephone numbers:

International	<a href="http://www.aten.com">http://www.aten.com</a>
North America	<a href="http://www.aten-usa.com">http://www.aten-usa.com</a>

This Page Intentionally Left Blank

# Chapter 1

## Introduction

### Overview

---

The CS231 / CS231TK is a powerful, micro-processor controlled computer sharing device. It is a multi-user, single-tasking device that enables two users to share the use of a single USB or PS/2 computer from two separate consoles (USB keyboard, USB mouse, and monitor).

The CS231 / CS231TK is ideal for small office and home office (SOHO) environments. All programs, files and resources on the computer can be easily accessed and shared by both users without the bother and expense of setting up a costly network environment.

CS231TK is CS231 that bundled with KVM over IP Access Control Box. The 2XRT-0015G KVM over IP Access Control Box allows users to enable or disable remote over IP control privilege by simply pressing a control button.

It's fast and easy to set up the 2XRT-0015G. Simply plug the 2XRT-0015G's cables to the CS231 / CS231TK. There is no need to install software or configure devices - just plug and play,.

In addition, the cable length of the 2XRT-0015G reaches 5 meters, enabling connection to the transmitter over longer distances for more flexible installation.

## Features

---

### **CS231 / CS231TK**

- ◆ Single computer shared by two USB consoles
- ◆ Supports USB and PS/2 computers
- ◆ Multiplatform support (Windows, Mac, Unix, and Linux)
- ◆ Manual or Auto console selection
- ◆ Control the system with Hotkeys
- ◆ Firmware upgradable
- ◆ Private Mode for a privileged user
- ◆ Screen Saver function
- ◆ Choose from four Timeout settings
- ◆ Supports VGA, SVGA, and MultiSync monitors
- ◆ No software required

### **2XRT-0015G KVM over IP Access Control Box**

- ◆ Users at the Tx local console can enable / disable Rx control privilege by simply pressing a control button
- ◆ Plug and play - no software installation required on either side
- ◆ USB bus-powered design - no external power adapter required
- ◆ Easy to operate
- ◆ Cable length reaches 5m for more flexible installation

---

**Note:** 2XRT-0015G KVM over IP Access Control Box only comes in the CS231TK package.

---

## **System Requirements**

---

### **Operating System:**

- ◆ Microsoft® Windows® 98SE, ME, 2000, XP, 2003 or later
- ◆ Red Hat Linux 7.1, 7.2, 7.3, 8.0 or later
- ◆ Mandriva Linux 9.0 or later
- ◆ SUSE 8.2 or later
- ◆ FreeBSD 4.2, 4.3, 4.5 or later
- ◆ Netware 6.0 or later
- ◆ Netware 5.0 (PS/2 computers only)
- ◆ Mac OS 8.6, 9.0, 9.1, X, 10.1, 10.2, 10.3, 10.4 or later

### **Cables**

Use ATEN's high-quality, custom cables to ensure reliable switching among consoles. To purchase ATEN's custom cables contact your dealer.

Description	Part Number
PS/2 KVM Cables	2L-5202P (1.8 m)
	2L-5203P (3 m)
	2L-5206P (6 m)
USB KVM Cables	2L-5201U (1.2 m)
	2L-5202U (1.8 m)
	2L-5203U (3 m)
	2L-5205U (5 m)

## Components

### CS231 / CS231TK Front View



No.	Component	Description
1	MANUAL/AUTO Selection Button	This button is used to switch between Manual and Auto Modes. The default is Auto Mode. Repeatedly pressing the button cycles through the modes in the following order: Auto Mode -> Console 1 (Manual) -> Console 2 (Manual) -> Auto Mode.
2	C1 LED*	Lights when Console 1 accesses the computer. Turns off when Console 2 accesses the computer.
3	C2 LED*	Lights when Console 2 accesses the computer. Turns off when Console 1 accesses the computer.
4	MANUAL LED	Lights to indicate that the CS231 / CS231TK is set to Manual Mode. In Auto Mode the LED does not illuminate.

\* In Auto Mode, when neither console is accessing the computer, both Console LEDs are illuminated.

## CS231 / CS231TK Rear View

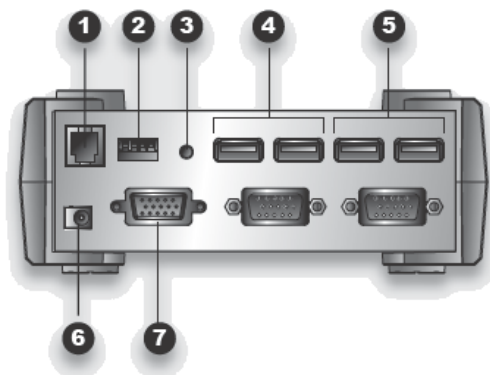

No.	Component	Description
1	Firmware Upgrade Port	The firmware upgrade cable connects here and to the administrator's computer to upgrade the firmware (see <i>The Firmware Upgrade Utility</i> , page 17).
2	DIP Switch	This is a 4-pin DIP switch. Use it to set the Timeout, Private Mode, and Screen Saver functions (see <i>DIP Switch Settings Table</i> , page 13).
3	Reset Button	Press this semi-recessed button to reset the system.
4	Console 2 Ports	The cables from the VGA monitor and USB keyboard and mouse of Console 2 plug in here.
5	Console 1 Ports	The cables from the VGA monitor and USB keyboard and mouse of Console 1 plug in here.
6	Power Jack	The power adapter cable plugs in here.
7	PC Port*	The 15-pin SPHD connector on the provided KVM cable plugs in here. At the other end of the cable, the HDB-15 and USB connector plug into the corresponding ports on the computer. If the computer does not have an available USB port, a KVM cable with PS/2 keyboard and mouse connectors may be purchased separately.

\* The shape and pin assignment of this 15-pin SPHD connector has been specifically modified so that only KVM cables designed to work with this switch may be used. Do NOT attempt to use a cable with ordinary 15-pin VGA connectors to link this port to the computer.

## **2XRT-0015G KVM over IP Access Control Box Front View**

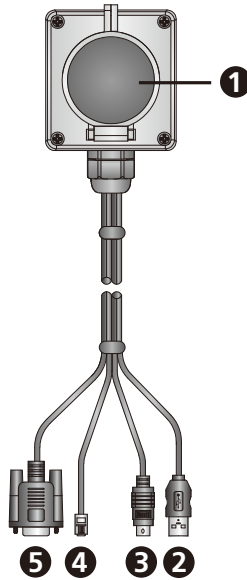

No.	Component	Description	Indication
1	Control Button / LED	Press the button to enable or disable remote over IP control access.	Lights red
2	USB Connector	Connects to a USB port to power on the device.	
3	PS/2 Connector	Connects to the PS/2 port for control access.	
4	RJ-11 Connector	Connects to the RJ-11 port for control access.	
5	RJ-232 Connector	Connects to the RS-232 port for control access.	

**Note:** 2XRT-0015G KVM over IP Access Control Box only comes in the CS231TK package.

# Chapter 2

## Hardware Setup

### Before You Begin

---



1. To prevent damage to your installation from power surges or static electricity. It is important that all connected devices are properly grounded.
2. Make sure that power to all the devices you will be connecting up have been turned off. You must unplug the power cords of any computers that have the Keyboard Power On function.

Installing your new CS231 / CS231TK involves the following seven steps (refer to the diagram on the following page):

1. Connect the 15-pin SPHD connector on the KVM cable to the PC port on the CS231 / CS231TK.
2. Connect the VGA video connector on the KVM cable to the VGA video output port on the computer. Plug the USB connector into any available USB port.
3. Plug the keyboard, mouse and monitor for the console that you want to designate as Console 1 into the Console 1 ports.
4. Plug the keyboard, mouse and monitor for the console that you want to designate as Console 2 into the Console 2 ports.
5. Set the DIP switch (see *DIP Switch Settings Table*, page 13, for details).
6. Plug the RJ-11 connector of the 2XRT-0015G to the Firmware Upgrade Port on the rear side of the CS231TK.

---

**Note:** This step is only for CS231TK that includes 2XRT-0015G KVM over IP Access Control Box in the CS231TK package. If your package is CS231, you can omit this step.

---

7. Plug the power adapter into an AC power source; plug the power adapter cable into the power jack on the CS231 / CS231TK.
8. Power on the computer and monitors.

## Installation Diagram

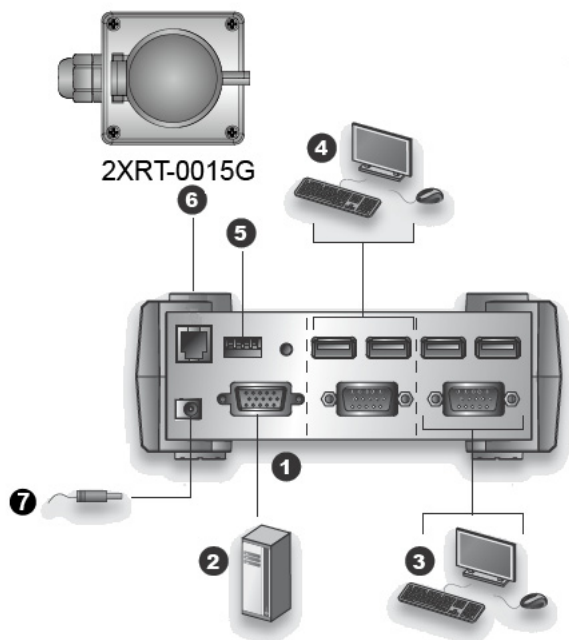

# Chapter 3

## Basic Operation

### Overview

---

For CS231TK that comes with the CS231 package including the 2XRT-0015G KVM over IP Access Control Box. The 2XRT-0015G KVM over IP Access Control Box allows users to enable or disable remote over IP control privilege by simply pressing a control button.

### 2XRT-0015G KVM over IP Access Control Box

---

**Note:** 2XRT-0015G KVM over IP Access Control Box only comes in the CS231TK package.

---

2XRT-0015G KVM over IP Access Control Box is a control button accessory to enable / disable remote KVM over IP access.

### LED statuses

Button Status	LED	Function
Pressed	Red Light	Disable remote access
Released	Dim	Enable remote access

This Page Intentionally Left Blank

# Chapter 4

## Operation

### Overview

---

The CS231 / CS231TK features two operation modes: Auto Mode and Manual Mode.

### Auto Mode

Auto Mode operates according to the following rules:

1. When the CS231 / CS231TK is turned on it starts in Auto Mode, and operates on a first-come-first-served basis. Both Console LEDs are On; the Manual LED is Off.
2. The first user to strike the keyboard or move the mouse gains control of the computer. As soon as this occurs:
  - ◆ The Console LED that corresponds to the user's console turns On.
  - ◆ The Console LED for the other console turns Off.
  - ◆ The CS231 / CS231TK locks onto that user's console.
  - ◆ A message appears on the other user's monitor indicating that the system is in use. After 10 seconds, the message disappears and the user can view the computer display. If the user strikes the keyboard or moves the mouse, the OSD message is displayed again.
  - ◆ The user who has control of the computer can prevent the other user from viewing the computer display by entering the following Hotkey combination:  
[Num Lock]+[-],[D]  
If the other user strikes the keyboard or moves the mouse, a message appears indicating that the system is in use. After 10 seconds, the message disappears and the monitor displays a black background. If the user strikes the keyboard or moves the mouse, the OSD message is displayed again.
3. If the user who has access does not strike the keyboard or move the mouse before the Timeout Period (set with DIP switch pins 1 and 2) elapses:
  - ◆ The CS231 / CS231TK unlocks from that user's console;
  - ◆ Then, the CS231 / CS231TK switches to Auto Mode;
  - ◆ Both Console LEDs turn On;
  - ◆ The Manual LED is Off (since the CS231 / CS231TK is in Auto Mode);
  - ◆ Either console may take control of the computer.

4. To terminate Auto Mode access, repeatedly press the MANUAL/AUTO Button until the desired console controls the device.

### **Timeout**

In Auto Mode, the setting of DIP switch pins 1 and 2 determines the amount of time that passes from the last input by the controlling console to when the console lock is released. Refer to the *DIP Switch Settings Table*, page 13 for the pin settings and their corresponding Timeout lengths. (See page 11 for more information about Auto Mode.)

---

**Note:** For best results, set the DIP switch pins BEFORE turning on either the CS231 / CS231TK or the computer.

---

### **Private Mode (Console 1)**

Private Mode operates within Auto Mode. In Private Mode, the Console 1 user can control the computer, while preventing the Console 2 user from viewing and controlling the computer. The Timeout Period does not apply in Private Mode.

To enter Private Mode:

1. Make sure that the device is in Auto Mode and that DIP switch pin 3 is set to the On position.
2. Wait for the Timeout period to expire.
3. From the keyboard of Console 1, press the Shift key six times within two seconds.

After the Timeout Period expires, Console 1 will display the computer desktop and have control of the computer. A message appears on the monitor of Console 2 indicating that the system is in use. After 10 seconds, the message disappears and the monitor displays a black background. If the Console 2 user strikes the keyboard or moves the mouse, the OSD message is displayed again.

To exit Private Mode:

1. From the keyboard of Console 1, press the Shift key six times within 2 seconds; or, press the MANUAL/AUTO Button.

### **Screen Saver**

To protect the screen phosphors, when the CS231 / CS231TK is in Auto Mode and no one is accessing the computer, a stripe image can scroll down the screen. To enable this function, set DIP switch pin 4 to the On position.

## DIP Switch Settings Table

DIP Switch Pins				Function
1	2	3	4	
On	On	X	X	5 Second Timeout
Off	On	X	X	60 Second Timeout
On	Off	X	X	125 Second Timeout
Off	Off	X	X	255 Second Timeout
X	X	On	X	Private Mode Enabled
X	X	Off	X	Private Mode Disabled
X	X	X	On	Screen Saver Enabled
X	X	X	Off	Screen Saver Disabled

**Note:** Press a DIP switch pin down to turn it on, up to turn it off.

## Manual Mode

Manual Mode is used to access the computer for a longer period of time. It is invoked by repeatedly pressing the MANUAL/AUTO Button to bring the focus to the desired console as follows:

Auto Mode > Console 1 > Console 2 > Auto Mode

- ◆ When Manual Mode is invoked, the CS231 / CS231TK switches to the selected console and prohibits the other console from controlling the computer. The selected console retains control until the MANUAL/AUTO Button is pressed again.
- ◆ A message appears on the other user's monitor indicating that the system is in use. After 10 seconds, the message disappears and the user can view the computer display. If the user strikes the keyboard or moves the mouse, the OSD message is displayed again.
- ◆ The user who has control of the computer can prevent the other user from viewing the computer display by entering the following Hotkey combination:

[Num Lock] + [-], [D]

If the other user strikes the keyboard or moves the mouse, a message appears indicating that the system is in use. After 10 seconds, the message disappears and the monitor displays a black background. If the user strikes the keyboard or moves the mouse, the OSD message is displayed again.

To switch to the other console, repeatedly press the Manual/Auto Mode Button until the desired console controls the device, or enter the following hotkey combination:

[Scroll Lock], [Scroll Lock], [Enter]

---

**Note:** 1. This hotkey combination is for CS231 only.

2. If using the Scroll Lock key conflicts with other programs running on the computer, the Ctrl key can be used instead. See *HSM Summary Table*, page 14, for details.
- 

## Hotkey Setting Mode

---

Hotkey Setting Mode is used to configure your CS231 / CS231TK switch. All operations begin with invoking Hotkey Setting Mode (HSM).

Invoking HSM

To invoke HSM do the following:

1. Press and hold down the **Num Lock** key.
  2. Press and release the **minus [-]** key.
  3. Release the **Num Lock** key.
- 

**Note:** 1. The minus key must be released within one-half second, otherwise Hotkey invocation is canceled.

2. There is an alternate key combination to invoke HSM. See *HSM Summary Table*, page 14, for details.
- 

## HSM Summary Table

After invoking HSM (see **page 14**), key in one of the following keys to perform the corresponding function:

Key	Function
[F1]	Sets the PC keyboard layout.
[F2]	Sets the Apple keyboard layout. (Set this before turning on the Mac computer.)
[F4]	Lists the current hotkey settings via the <i>Paste</i> function of a text editor.
[F5]	Performs a USB reset.

---

[D]	Turn the other console's monitor off or on. (This setting applies until changed or until the device is powered off.)
[H]	Toggles between the default and alternate HSM invocation keys. The alternate HSM invocation keys are [Ctrl] + [F12].
[R], [Enter]	Restores the default Hotkey settings.
[T]	Toggles between the default and alternate console switching keys. The default console switching keys are [Scroll Lock] [Scroll Lock] [Enter]. The alternate console switching keys are [Ctrl] [Ctrl] [Enter].
[upgrade], [Enter]*	Invokes Firmware Upgrade Mode.







\* Key in the letters u-p-g-r-a-d-e, and then press [Enter].

## Keyboard Emulation Mapping

### Apple Keyboard

The PC compatible (101/104 key) keyboard can emulate the functions of the Apple keyboard. The corresponding functions are shown in the table below.

**Note:** When using hotkey combinations, press and release the first key, then press and release the second one.

PC Keyboard	Mac Keyboard
[Shift]	Shift
[Ctrl]	Ctrl
	
[Ctrl], [1]	
[Ctrl], [2]	
[Ctrl], [3]	
[Ctrl], [4]	
[Alt]	Alt
[Print Screen]	F13
[Scroll Lock]	F14
	=

[Enter]	Return
[Backspace]	Delete
[Insert]	Help
[Ctrl], 	F15

# Chapter 5

## The Firmware Upgrade Utility

### Introduction

---

The Windows-based Firmware Upgrade Utility (FWUpgrade.exe) provides a smooth, automated process for upgrading the computer sharing device's firmware.

The Utility comes as part of a Firmware Upgrade Package that is specific for each device. New firmware upgrade packages are posted on our Website as new firmware revisions become available. Check our Website regularly to find the latest packages and information relating to them.

### Before You Begin

To prepare for the firmware upgrade, do the following:

1. From a computer that is not part of your installation, go to our Website and choose the model name that relates to your device (CS231 / CS231TK) to get a list of available Firmware Upgrade Packages.
2. Choose the Firmware Upgrade Package you want to install (usually the most recent) and download it to your computer.
3. Shut down the computer(s) on your CS231 / CS231TK installation.
4. Connect the provided firmware upgrade cable to the firmware upgrade port on the CS231 / CS231TK and to a COM port on the computer you used to download the Firmware Upgrade Package.
5. From the console connected to the CS231 / CS231TK, invoke HSM (see page 14). Key in the letters u-p-g-r-a-d-e, and then press [Enter]. When in firmware upgrade mode the front panel LEDs flash in unison.

### Starting the Upgrade

To upgrade your firmware:

1. Run the downloaded Firmware Upgrade Package file - either by double clicking the file icon, or by opening a command line and entering the full path to it.

The Firmware Upgrade Utility *Welcome* screen appears:

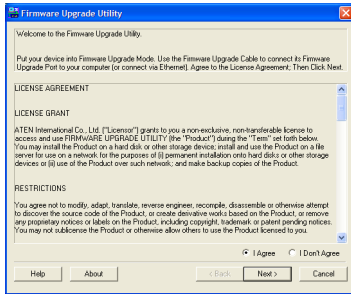

2. Read and *Agree* to the License Agreement (enable the I Agree radio button).
3. Click Next to continue. The Firmware Upgrade Utility main screen appears:

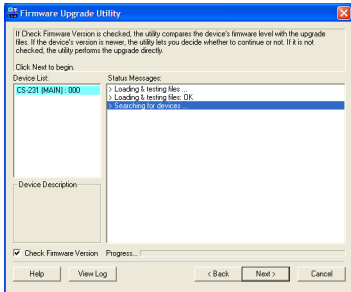

The Utility inspects your installation. All the devices capable of being upgraded by the package are listed in the *Device List* panel.

4. As you select a device in the list, its description appears in the *Device Description* panel.

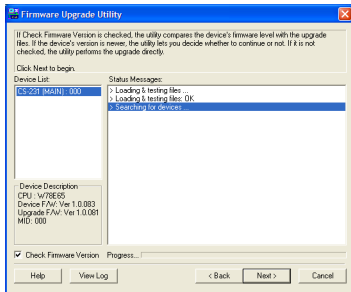

5. After you have made your device selection(s), Click **Next** to perform the upgrade.

If you enabled *Check Firmware Version*, the Utility compares the device's firmware level with that of the upgrade files. If it finds that the device's version is higher than the upgrade version, it brings up a dialog box informing you of the situation and gives you the option to Continue or Cancel.

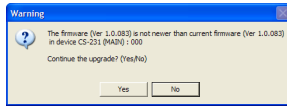

If you did not enable *Check Firmware Version*, the Utility installs the upgrade files without checking whether or not they are a higher level.

As the Upgrade proceeds, status messages appear in the Status Messages panel, and the progress toward completion is shown on the *Progress* bar.

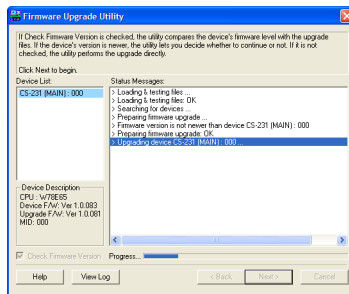

## Upgrade Succeeded

After the upgrade has completed, a screen appears to inform you that the procedure was successful:

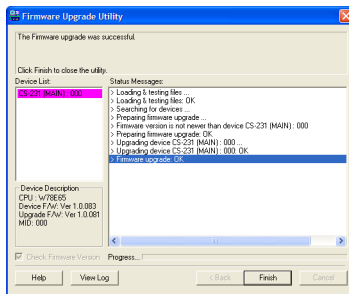

Click **Finish** to close the Firmware Upgrade Utility.

After a successful completion, the switches exit Firmware Upgrade Mode.

## **Upgrade Failed**

If the *Upgrade Succeeded* screen does not appear, then the upgrade failed to complete successfully. You should repeat the upgrade procedure from the beginning.

## Safety Instructions

---

### General

- ◆ This product is for indoor use only.
- ◆ Read all of these instructions. Save them for future reference.
- ◆ Follow all warnings and instructions marked on the device.
- ◆ Do not place the device on any unstable surface (cart, stand, table, etc.). If the device falls, serious damage will result.
- ◆ Do not use the device near water.
- ◆ Do not place the device near, or over, radiators or heat registers.
- ◆ The device cabinet is provided with slots and openings to allow for adequate ventilation. To ensure reliable operation, and to protect against overheating, these openings must never be blocked or covered.
- ◆ The device should never be placed on a soft surface (bed, sofa, rug, etc.) as this will block its ventilation openings. Likewise, the device should not be placed in a built in enclosure unless adequate ventilation has been provided.
- ◆ Never spill liquid of any kind on the device.
- ◆ Unplug the device from the wall outlet before cleaning. Do not use liquid or aerosol cleaners. Use a damp cloth for cleaning.
- ◆ The device should be operated from the type of power source indicated on the marking label. If you are not sure of the type of power available, consult your dealer or local power company.
- ◆ The device is designed for IT power distribution systems with 230V phase-to-phase voltage.
- ◆ To prevent damage to your installation it is important that all devices are properly grounded.
- ◆ The device is equipped with a 3-wire grounding type plug. This is a safety feature. If you are unable to insert the plug into the outlet, contact your electrician to replace your obsolete outlet. Do not attempt to defeat the purpose of the grounding-type plug. Always follow your local/national wiring codes.
- ◆ Do not allow anything to rest on the power cord or cables. Route the power cord and cables so that they cannot be stepped on or tripped over.

- ◆ If an extension cord is used with this device make sure that the total of the ampere ratings of all products used on this cord does not exceed the extension cord ampere rating. Make sure that the total of all products plugged into the wall outlet does not exceed 15 amperes.
- ◆ To help protect your system from sudden, transient increases and decreases in electrical power, use a surge suppressor, line conditioner, or uninterruptible power supply (UPS).
- ◆ Position system cables and power cables carefully; Be sure that nothing rests on any cables.
- ◆ Never push objects of any kind into or through cabinet slots. They may touch dangerous voltage points or short out parts resulting in a risk of fire or electrical shock.
- ◆ Do not attempt to service the device yourself. Refer all servicing to qualified service personnel.
- ◆ If the following conditions occur, unplug the device from the wall outlet and bring it to qualified service personnel for repair.
  - ◆ The power cord or plug has become damaged or frayed.
  - ◆ Liquid has been spilled into the device.
  - ◆ The device has been exposed to rain or water.
  - ◆ The device has been dropped, or the cabinet has been damaged.
  - ◆ The device exhibits a distinct change in performance, indicating a need for service.
  - ◆ The device does not operate normally when the operating instructions are followed.
- ◆ Only adjust those controls that are covered in the operating instructions. Improper adjustment of other controls may result in damage that will require extensive work by a qualified technician to repair.
- ◆ Do not connect the RJ-11 connector marked “UPGRADE” to a public telecommunication network.

## Technical Support

---

### International

- ◆ For online technical support – including troubleshooting, documentation, and software updates: <http://support.aten.com>
- ◆ For telephone support, see *Telephone Support*, page iv:

### North America

Email Support		<a href="mailto:support@aten-usa.com">support@aten-usa.com</a>
Online Technical Support	Troubleshooting Documentation Software Updates	<a href="http://www.aten-usa.com/support">http://www.aten-usa.com/support</a>
Telephone Support		1-888-999-ATEN ext 4988

When you contact us, please have the following information ready beforehand:

- ◆ Product model number, serial number, and date of purchase
- ◆ Your computer configuration, including operating system, revision level, expansion cards, and software
- ◆ Any error messages displayed at the time the error occurred
- ◆ The sequence of operations that led up to the error
- ◆ Any other information you feel may be of help

## Specifications

Function		CS231	
Computer Connections		1	
Console Connections		2	
Console Selection		Hotkey, Pushbutton	
Connectors	Console Port	Keyboard	2 x USB Type A Female (White)
		Video	2 x HDB-15 Female (Blue)
		Mouse	2 x USB Type A Female (White)
	Computer Port		1 x SPHD-15 Female (Green)
	F/W Upgrade		1 x RJ-11 Female (Black)
	Power		1 x DC Jack (Black)
	Switches	Mode Selection	
Reset		1 x Semi-recessed Pushbutton	
DIP		1 x 4-pin	
LEDs	Mode		1 (Orange)
	Selected		2 (Green)
Video		1920x1440@60Hz; DDC2B	
Timeout Settings		5, 60, 125, 255 Seconds	
Power Consumption		DC 5.3V, 1.6W, 16BTU	
Environment	Operating Temp.		0–50° C
	Storage Temp.		-20–60° C
	Humidity		0–80% RH, Non-condensing
Physical Properties	Housing		Metal
	Weight		0.56 kg (1.23 lb)
	Dimensions (L x W x H)		14.00 x 8.80 x 5.55 cm (5.51 x 3.46 x 2.19 in.)

Function	2XRT-0015G
<b>Connectors</b>	
Link	USB, PS/2, RJ-11, RS-232

Function	2XRT-0015G
<b>LEDs</b>	
Status	Pressed: Red Light Released: Dim
<b>Physical Properties</b>	
Housing	Plastic
Weight	0.43 kg (0.95 lb)
Dimensions (L x W x H)	7.2 x 10.39 x 11.00 cm (2.83 x 4.09 x 4.33 in.)

**Note:** 2XRT-0015G KVM over IP Access Control Box only comes in the CS231TK package.

## Troubleshooting

Problem	Solution
Nothing happens when I move the mouse or press keys on the keyboard.	<ol style="list-style-type: none"> <li>1. Ensure that the KVM cable connectors are firmly secured to the computer port on the CS231 / CS231TK and to the keyboard and mouse ports on the computer before connecting the power cable or turning on the computer.</li> <li>2. Press the Manual/Auto Mode Button to switch the console.</li> </ol>
I am using two monitors with differing screen resolutions. Why can't I see the entire desktop on the monitor with the higher resolution?	The monitor with the lowest screen resolution sets the maximum screen resolution that can be used. Choose a screen resolution in the computer's graphics card that is supported by both monitors.
After setting a PC keyboard to emulate the Apple keyboard layout, it still is not emulating the Mac keyboard.	Restart the computer.

## Limited Warranty

---

ATEN warrants its hardware in the country of purchase against flaws in materials and workmanship for a Warranty Period of two [2] years (warranty period may vary in certain regions/countries) commencing on the date of original purchase. This warranty period includes the LCD panel of ATEN LCD KVM switches. Select products are warranted for an additional year (see *A+ Warranty* for further details). Cables and accessories are not covered by the Standard Warranty.

### **What is covered by the Limited Hardware Warranty**

ATEN will provide a repair service, without charge, during the Warranty Period. If a product is defective, ATEN will, at its discretion, have the option to (1) repair said product with new or repaired components, or (2) replace the entire product with an identical product or with a similar product which fulfills the same function as the defective product. Replaced products assume the warranty of the original product for the remaining period or a period of 90 days, whichever is longer. When the products or components are replaced, the replacing articles shall become customer property and the replaced articles shall become the property of ATEN.

To learn more about our warranty policies, please visit our website:

<http://www.aten.com/global/en/legal/policies/warranty-policy/>