



USER MANUAL

MODEL:

WP-SW2-EN7
4K AVoIP Encoder



Contents

Introduction	3
Getting Started	3
Overview	4
Typical Applications	5
Defining WP-SW2-EN7	6
Mounting WP-SW2-EN7	8
Connecting WP-SW2-EN7	9
Connecting to WP-SW2-EN7 via RS-232	10
Operating and Controlling WP-SW2-EN7	11
Configuring the Network Switch	11
Configuring the WP-SW2-EN7	11
Operating via Ethernet	12
Connecting Ethernet Port Directly to a PC	12
Using WP-SW2-EN7 Embedded Web Pages	15
Opening the WP-SW2-EN7 Web Pages	15
Setting AV Routing Parameters	17
Defining Switching Mode	18
Defining Signal Loss Timeouts	19
Activating HDCP Protection	20
Defining Audio Settings	21
Managing EDID	22
Defining General Settings	23
Defining Network Settings	26
Defining an NTP Time and Date Server	29
Setting WP-SW2-EN7 Security	30
Controlling User Access	32
Defining WP-SW2-EN7 Gateway Settings	35
Viewing WP-SW2-EN7 Status	37
Viewing WP-SW2-EN7 Connections Status	38
Viewing the WP-SW2-EN7 Logs	39
Viewing the About Page	40
Upgrading Firmware	41
Technical Specifications	42
Default Communication Parameters	43
Default EDID	43
Default Parameters	46
Protocol 3000	47
Understanding Protocol 3000	47
Protocol 3000 Commands	48
Result and Error Codes	58

Introduction

Welcome to Kramer Electronics! Since 1981, Kramer Electronics has been providing a world of unique, creative, and affordable solutions to the vast range of problems that confront the video, audio, presentation, and broadcasting professional on a daily basis. In recent years, we have redesigned and upgraded most of our line, making the best even better!

Getting Started

We recommend that you:

- Unpack the equipment carefully and save the original box and packaging materials for possible future shipment.
- Review the contents of this user manual.



Go to www.kramerav.com/downloads/WP-SW2-EN7 to check for up-to-date user manuals, application programs, and to check if firmware upgrades are available (where appropriate).

Achieving Best Performance

- Use only good quality connection cables (we recommend Kramer high-performance, high-resolution cables) to avoid interference, deterioration in signal quality due to poor matching, and elevated noise levels (often associated with low quality cables).
- Do not secure the cables in tight bundles or roll the slack into tight coils.
- Avoid interference from neighboring electrical appliances that may adversely influence signal quality.
- Position your Kramer **WP-SW2-EN7** away from moisture, excessive sunlight and dust.

Safety Instructions



Caution:

- This equipment is to be used only inside a building. It may only be connected to other equipment that is installed inside a building.
- For products with relay terminals and GPIO ports, please refer to the permitted rating for an external connection, located next to the terminal or in the User Manual.
- There are no operator serviceable parts inside the unit.



Warning:

- Use only the power cord that is supplied with the unit.
- To ensure continuous risk protection, replace fuses only according to the rating specified on the product label which is located on the bottom of the unit.

Recycling Kramer Products

The Waste Electrical and Electronic Equipment (WEEE) Directive 2002/96/EC aims to reduce the amount of WEEE sent for disposal to landfill or incineration by requiring it to be collected and recycled. To comply with the WEEE Directive, Kramer Electronics has made arrangements with the European Advanced Recycling Network (EARN) and will cover any costs of treatment, recycling and recovery of waste Kramer Electronics branded equipment on arrival at the EARN facility. For details of Kramer's recycling arrangements in your particular country go to our recycling pages at www.kramerav.com/quality/environment.

Overview

Congratulations on purchasing your Kramer **WP-SW2-EN7 4K AVoIP Encoder**.

WP-SW2-EN7 is an auto switcher and advanced encoder for streaming 4K@60Hz (4:2:0) a selected video signal, RS-232, or CEC signals via Ethernet over copper cable in unicast (one-to-one) or multicast (one-to-many) configurations.

WP-SW2-EN7 encodes and streams the video signal from one of two selectable inputs, and transmits USB, RS-232, or CEC signals over an IP network. The Kramer **WP-DEC7** decodes the video signal and receives USB, RS-232, or CEC signals.

WP-SW2-EN7 provides exceptional quality, advanced and user-friendly operation, and flexible control.

Exceptional Quality

- Instantaneous Switching Time – 1 second switching time between video inputs.
- Video Streaming Transmitter/receiver - Streams up to 4K@60Hz (4:2:0) resolution signals over a 1G network interface.
- HDR Support – HDR10 up to 4K@30Hz 4:2:2 12bits.
- Supports HDCP 2.2.
- Streaming Support – Provides unicast and multicast streaming.
- Flexible Analog Audio Embedding – Embed analog audio into the streaming audio signal and HDMI output, using the unbalanced 3.5mm stereo connector.

Advanced and User-friendly Operation

- Convenient and Comprehensive Control – Control the unit using intuitive embedded web pages, Protocol 3000 API commands via Ethernet, or the front panel channel display and recessed navigation buttons (on the US model access to the recessed buttons requires removal of the frame).
- PoE Support – Device power is supplied by a PoE (Power over Ethernet) connection from a PoE LAN switch.
- Control Gateway – Users can control/communicate with connected devices using P3K commands, a TCP connection with RS-232 or CECs.
- Separate Service LAN Port – A second LAN port is available for physical separation

between AV and command streams to improve security and reliability.

Flexible Connectivity

- Selectable Inputs – 1 HDMI and 1 USB-C input.
- Analog/embedded audio input.
- Plug-and-play with Netgear M4250 AVoIP switches, Kramer Control, KDS-USB2, etc.

Typical Applications

WP-SW2-EN7 is ideal for the following typical applications:

- Real-time essential installations such as command and control rooms.
- Large scale AV content sharing installations using existing wires and infrastructure in corporate offices and government applications.
- AV distribution systems with one or more sources and multiple displays in schools, universities, and public venues.

Controlling your WP-SW2-EN7

Control your **WP-SW2-EN7** via:

- The Ethernet using built-in user-friendly web pages.
- Protocol commands.

Defining WP-SW2-EN7

EU/UK

US

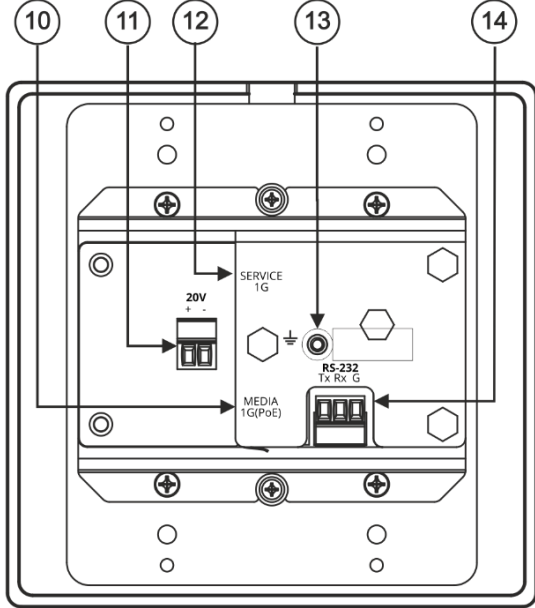
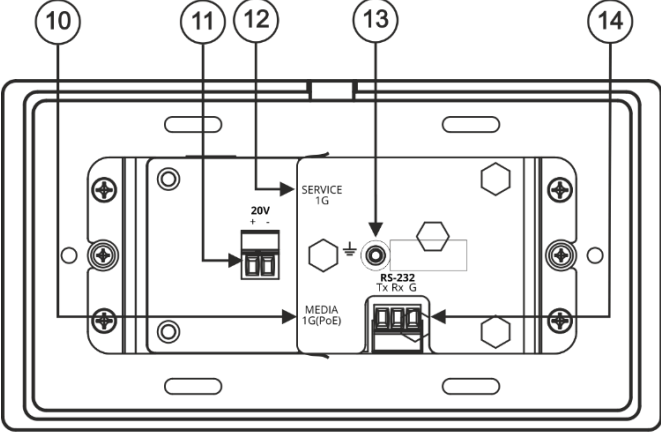
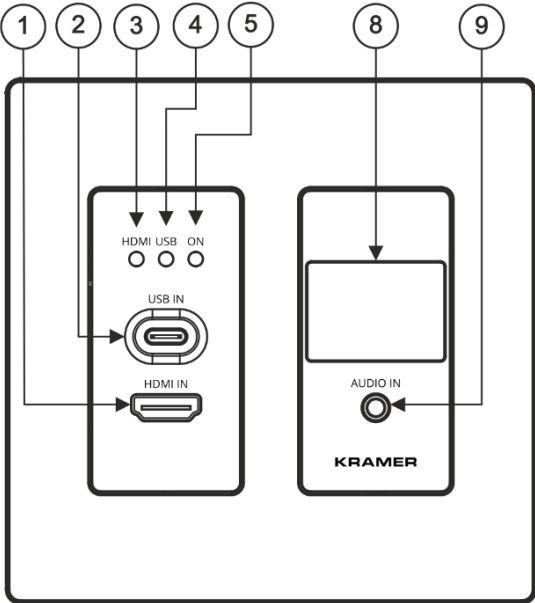
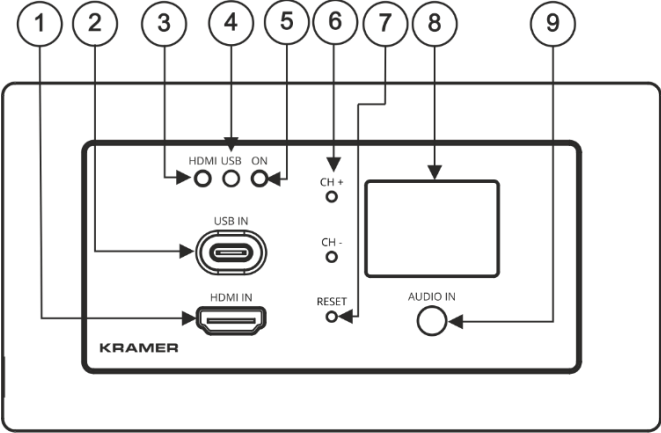

Figure 1: WP-SW2-EN7 4K AVoIP Encoder

#	Feature	Function	
①	HDMI IN Connector	Connect to an HDMI source.	
②	USB-C IN Port	Connect to a USB-C source. When powered by a Kramer 20V power supply (optional), charges sources (that support USB Power Delivery 2.0) up to 60W.	
③	HDMI LED	Lights Green	HDMI input is selected, HDMI is connected, and signal is received.
		Flashes Green	HDMI input is selected, HDMI is connected, and no signal is received.
		Off	The HDMI is not selected or not connected.
④	USB LED	Lights Green	USB-C input is selected, USB-C is connected, and signal is received.
		Flashes Green	USB-C input is selected, USB-C is connected, no signal is received.
		Off	USB-C is not selected or not connected.
⑤	ON LED	Flashes Red	On fallback address acquiring, device 'ON' LED flashes continuously in slow 0.5/10sec cadence.
		Lights Green	When power is on.
		Flashes Green Fast	Firmware is downloaded in the background.
		Flashes Green Very Fast (for 60sec)	A device identification command is sent (Flag me).
		Lights Orange	The default IP address 192.168.1.39 is in use, device is using fall back IP addresses in range 192.168.0.0 to 192.168.0.16.
⑥	CH+ / CH-	Click the recessed CH buttons to configure the channel ID. The selected channel ID is shown in the display panel (8). On the US model, access to these buttons requires removal of the frame.	
⑦	RESET	Press and hold for 10 seconds to reset the device to its factory default values. All LEDs flash. On the US model, access to this button requires removal of the frame.	
⑧	Display Panel	Shows the number of the channel used by WP-SW2-EN7 for streaming.	
⑨	AUDIO IN 3.5mm Mini Jack	Connect to an audio source.	
⑩	LAN MEDIA 1G(PoE) RJ-45 Port	Unicast: connect for streaming either directly to a decoder or via LAN. Multicast: connect to multiple decoders or connect to one decoder to which multiple decoders are daisy-chained via SERVICE (1G) port.	
⑪	20V/6A DC Connector	Connect to the power adapter (purchased separately).	
⑫	LAN SERVICE 1G RJ-45 Port	Used optionally for physical separation between AV and command streams to separate LAN for security and reliability purposes.	
⑬	Ring Tongue Terminal Grounding Screw	Connect to grounding wire (optional).	
⑭	RS-232 3-pin Terminal Block Connector	Connect to an RS-232 device to use as a Gateway and bi-directional signal extension (even when no AV signal is extended).	

Mounting WP-SW2-EN7

This section provides instructions for mounting **WP-SW2-EN7**. Before installing, verify that the environment is within the recommended range:



- Operation temperature – 0° to 40°C (32 to 104°F).
- Storage temperature – -40° to +70°C (-40 to +158°F).
- Humidity – 10% to 90%, RHL non-condensing.



Caution:

- Mount **WP-SW2-EN7** before connecting any cables or power.



Warning:

- Ensure that the environment (e.g., maximum ambient temperature & air flow) is compatible for the device.
- Avoid uneven mechanical loading.
- Appropriate consideration of equipment nameplate ratings should be used for avoiding overloading of the circuits.
- Reliable earthing of rack-mounted equipment should be maintained.
- Maximum mounting height for the device is 2 meters.

Insert the device into the in-wall box (first connect the RS-232 and LAN/POE RJ-45 Connector cables and/or power) and connect the parts as shown in the illustration:

EU/UK Version

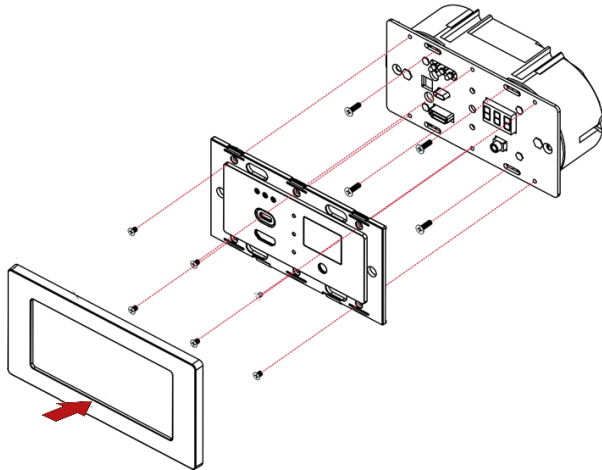

US-D Version

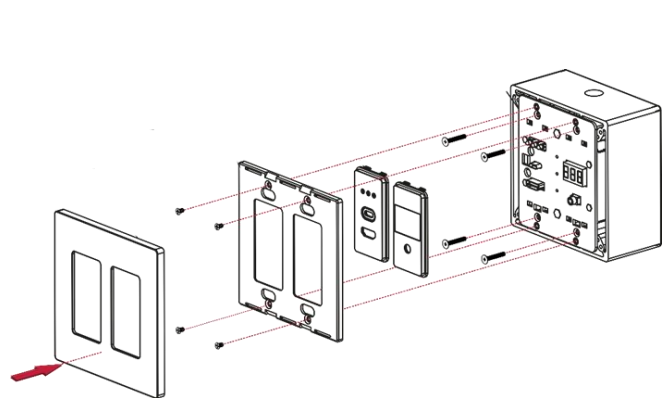

DECORA® design frames are included in US-D models.

We recommend that you use standard 2 gang in-wall junction boxes (or their equivalent):

US-D: 2 gang US electrical junction boxes.

EU: 2 gang in-wall junction box, with a cut-hole diameter of 2x68mm and depth that can fit in both the device and the connected cables (DIN 49073).

UK: 2 gang in-wall junction box (BS 4662), 135x75mm (W, H) and depth that can fit in both the device and the connected cables.

EU/UK: 2 gang in-wall junction box (use the recommended Kramer in-wall box available at www.kramerav.com/product/WP-SW2-EN7).

Connecting WP-SW2-EN7



By-default, this device uses PoE (Power over Ethernet) for powering the device. Optionally, you can separately purchase a power adapter to connect to the product and plug into the mains electricity.

Always switch off the power to a device before connecting it to your **WP-SW2-EN7**. After connecting your devices, connect their power and then switch on the power to each device.

In this example, **WP-SW2-EN7** is connected to **WP-DEC7**, but it can be connected to any compatible decoder.

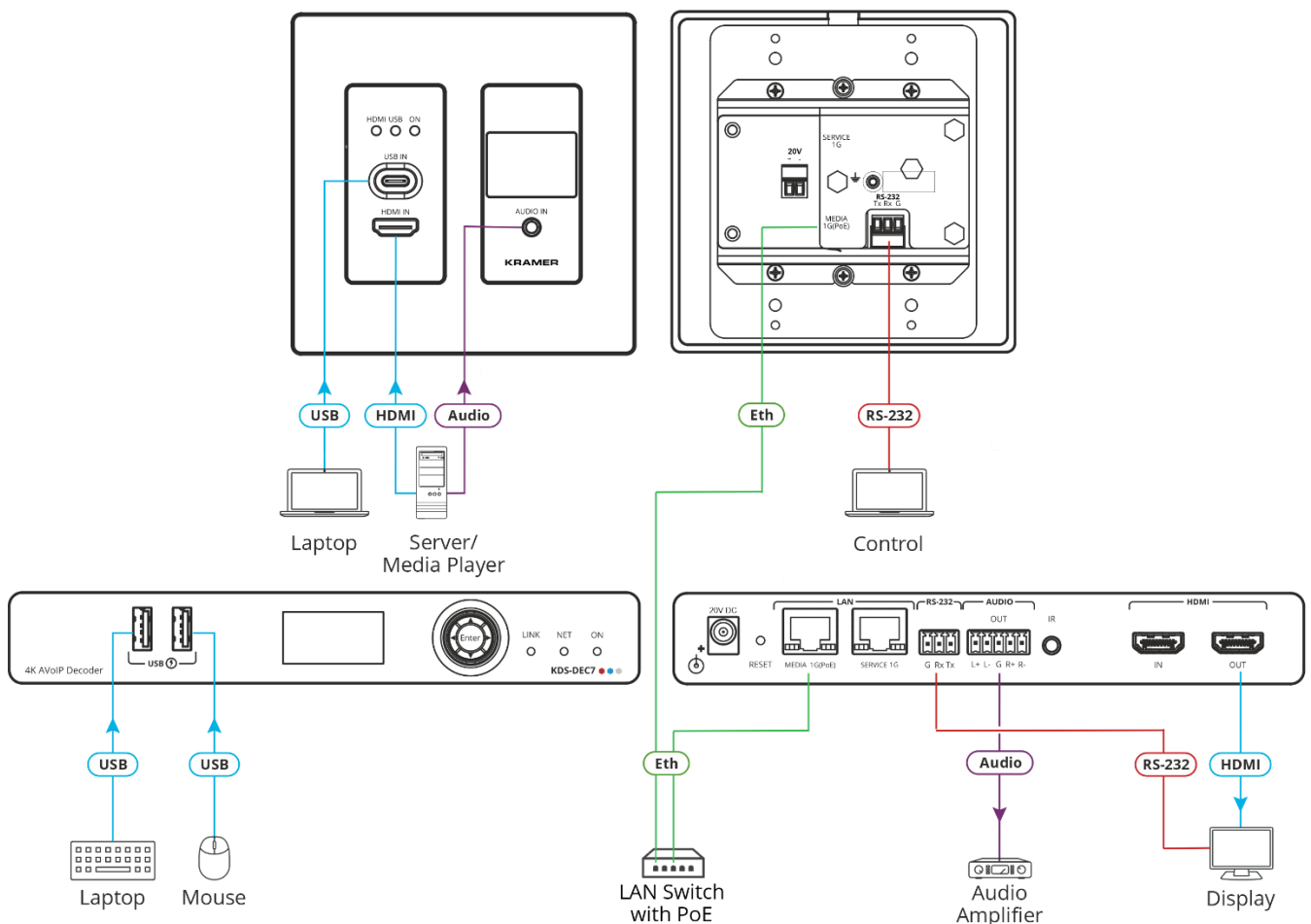

Figure 2: Connecting the WP-SW2-EN7 and WP-DEC7

To connect WP-SW2-EN7 as illustrated in the example in [Figure 2](#):

1. Either connect an HDMI source (for example, a server or a media player) to the HDMI IN connector (1) on the **WP-SW2-EN7**, or connect a video source (for example, a laptop) to the USB IN connector (2) on the **WP-SW2-EN7**.
2. Connect a stereo audio source (for example, the server audio connector) to the AUDIO IN connector (9) on the **WP-SW2-EN7**.
3. Connect the LAN MEDIA 1G(PoE) RJ-45 port (10) on the **WP-SW2-EN7** to a LAN switch with PoE and connect the LAN MEDIA 1G(PoE) RJ-45 port on the Kramer **WP-DEC7** decoder to the same LAN switch.

4. Connect the HDMI OUT connector on the **WP-DEC7** to an HDMI acceptor (for example, a display).
5. On **WP-DEC7**, connect a mouse and a keyboard to the two USB type A ports.
6. Connect RS-232 3-pin terminal block connectors:
 - On the **WP-SW2-EN7**, connect the RS-232 port ⑭ to a laptop/controller.
 - On the **WP-DEC7**, connect RS-232 to the display.



RS-232 bidirectional signals can be sent between the display and the laptop connected to the HDMI OUT connector on the **WP-DEC7**.

Connecting to WP-SW2-EN7 via RS-232

You can connect to **WP-SW2-EN7** via an RS-232 connection ⑭ using, for example, a PC. **WP-SW2-EN7** features an RS-232 3-pin terminal block connector allowing the RS-232 to control **WP-SW2-EN7**.

Connect the RS-232 terminal block on the rear panel of **WP-SW2-EN7** to a PC/controller, as follows:

From the RS-232 9-pin D-sub serial port, connect:

- Pin 2 to the TX pin on the **WP-SW2-EN7** RS-232 terminal block
- Pin 3 to the RX pin on the **WP-SW2-EN7** RS-232 terminal block
- Pin 5 to the G pin on the **WP-SW2-EN7** RS-232 terminal block

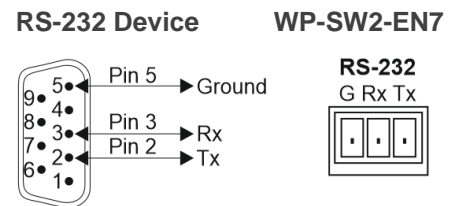

Operating and Controlling WP-SW2-EN7

This section describes the following actions:

- [Configuring the Network Switch](#) on page [11](#).
- [Configuring the WP-SW2-EN7](#) on page [11](#).
- [Operating via Ethernet](#) on page [12](#).
- [Connecting Ethernet Port Directly to a PC](#) on page [12](#).

Configuring the Network Switch

Before setting the system, make sure that your AV over IP network switch meets the following minimum requirements:

- Support for PoE, if it is being used to power **WP-SW2-EN7**.
- Jumbo Frames – On. (at least 8000 bytes).
- IGMP Snooping – On.
- IGMP Querier – On.
- IGMP Immediate/Fast Leave – On.



WP-SW2-EN7 supports multicast IGMPv2 version.

- Unregistered Multicast Filtering – On.

Configuring the WP-SW2-EN7

To start operating the **WP-SW2-EN7**:

- Use the recessed CH+/- buttons (6) to set the channel on which the encoded output is streamed. When reset or started for the first time, the device assigns a unique channel number for streaming, which is $n + 1$, where n is the highest channel number in use on the network.
- If **WP-SW2-EN7** detects a video signal from the HDMI port or the USB-C port that video is automatically streamed. By default, **WP-SW2-EN7** streams the USB-C input when a video signal is detected on both input ports.
- When video is streamed, the USB-C LED or HDMI LED light green, depending on the input port being streamed; The LEDs will flash green if no valid video is detected.

Use the Web UI to configure **WP-SW2-EN7** (see [Using WP-SW2-EN7 Embedded Web Pages](#) on page [15](#)).

Operating via Ethernet

The **WP-SW2-EN7**'s embedded Web UI provides high-level configuration options. Access to this UI requires an ethernet connection to the **WP-SW2-EN7** and that you identify its IP address.

To identify the device's IP address, use any of the following methods:

- Connect the **WP-SW2-EN7** ethernet port directly to a PC.

For instructions, see [Connecting Ethernet Port Directly to a PC](#) on page [12](#).

When connected to a PC, the **WP-SW2-EN7** is given the default static IP address: 192.168.1.39. If this IP address is already in use, the system will provide a random unique IP in the range of 192.168.X.Y

- Connect the Ethernet port of **WP-SW2-EN7** to the Ethernet port to a network hub, switch or router using a straight-through cable with RJ-45 connectors.

Make sure your PC is connected to the same LAN as the **WP-SW2-EN7**.

By default, the **WP-SW2-EN7** is DHCP-enabled. Make sure that there is a DHCP server in the network so the device can obtain a valid IP address.

You can change the Ethernet parameters via the embedded web pages (see [Using WP-SW2-EN7 Embedded Web Pages](#) on page [15](#)).

- Use the Kramer **KDS-7-MNGR** to discover the IP address, see www.kramerav.com/product/KDS-7-MNGR.

Connecting Ethernet Port Directly to a PC

You can connect the Ethernet port of **WP-SW2-EN7** directly to the Ethernet port on your PC using a crossover cable with RJ-45 connectors.



This type of connection is recommended for identifying **WP-SW2-EN7** with the factory configured default IP address.

After connecting **WP-SW2-EN7** to the Ethernet port, configure your PC as follows:

1. Click **Start > Control Panel > Network and Sharing Center**.
2. Click **Change Adapter Settings**.
3. Highlight the network adapter you want to use to connect to the device and click **Change settings of this connection**.

The Local Area Connection Properties window for the selected network adapter appears as shown in [Figure 3](#).

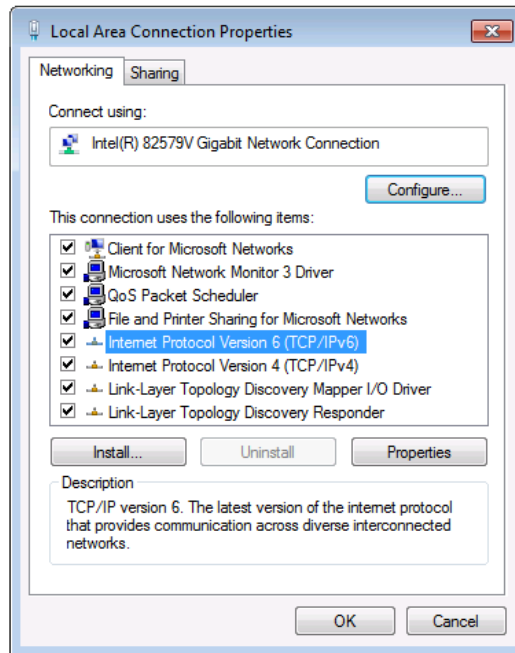

Figure 3: Local Area Connection Properties Window

4. Highlight either **Internet Protocol Version 6 (TCP/IPv6)** or **Internet Protocol Version 4 (TCP/IPv4)** depending on the requirements of your IT system.
5. Click **Properties**.

The Internet Protocol Properties window relevant to your IT system appears as shown in [Figure 4](#) or [Figure 5](#).

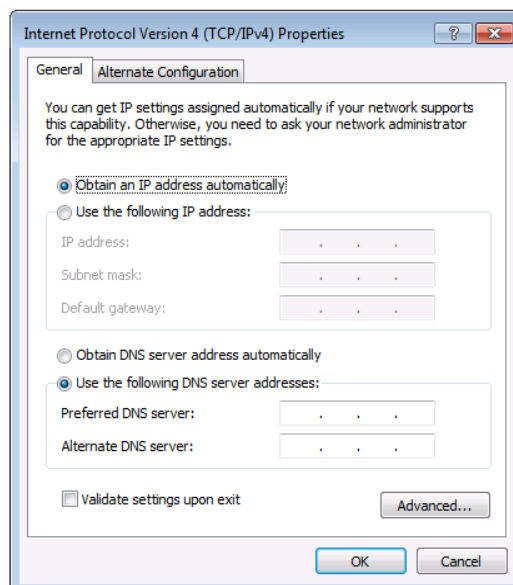

Figure 4: Internet Protocol Version 4 Properties Window

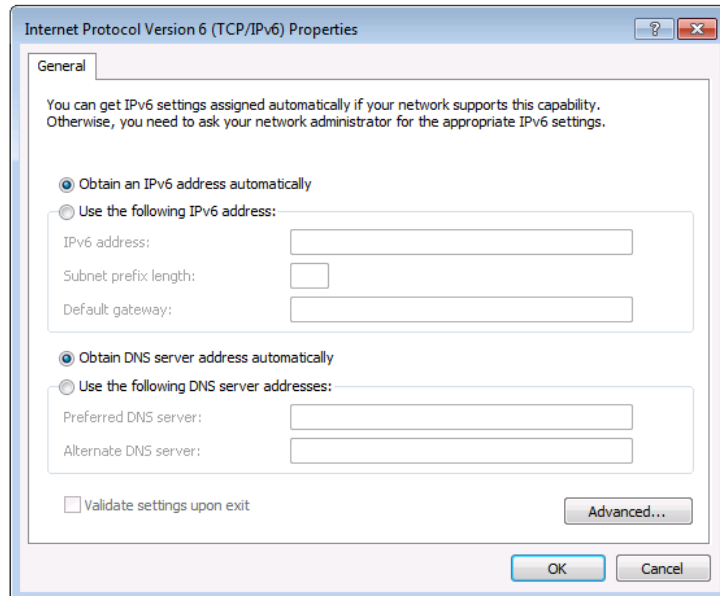

Figure 5: Internet Protocol Version 6 Properties Window

6. Select **Use the following IP Address** for static IP addressing and fill in the details as shown in [Figure 6](#).

For TCP/IPv4 you can use any IP address in the range 192.168.1.1 to 192.168.1.255 (excluding 192.168.1.39) that is provided by your IT department.

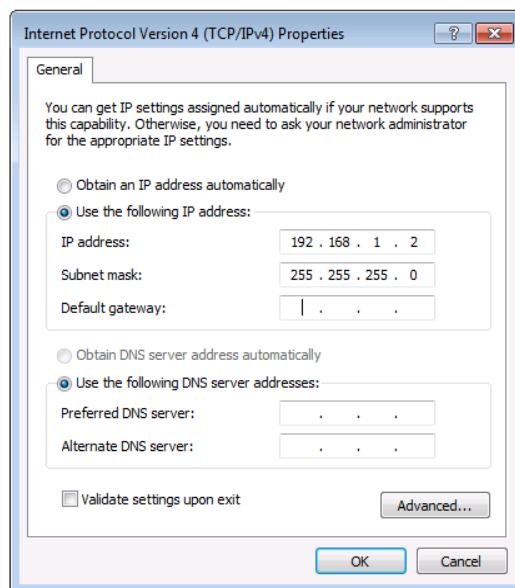

Figure 6: Internet Protocol Properties Window

7. Click **OK**.
8. Click **Close**.
9. Continue with [Using WP-SW2-EN7 Embedded Web Pages](#) on page [15](#).

Using WP-SW2-EN7 Embedded Web Pages

WP-SW2-EN7 can be operated remotely using the embedded web pages. Access to the web pages requires a Web browser and an Ethernet connection.

Before attempting to connect:

- Perform the procedures in [Operating via Ethernet](#) on page 12.
- Ensure that your browser is supported.

The following operating systems and Web browsers are supported:

Operating Systems	Browser
Windows 7	Firefox
	Chrome
	Safari
Windows 10	Edge
	Firefox
	Chrome
Mac	Safari
iOS	Safari
Android	N/A

 If a web page does not update correctly, clear your Web browser’s cache.

Opening the WP-SW2-EN7 Web Pages

To Browse the WP-SW2-EN7 Web Pages:

1. Open your Internet browser.
2. Type the IP number of the device in the Address bar of your browser. For example, the default IP number: .
3. If your device is password-protected, the Login window appears.

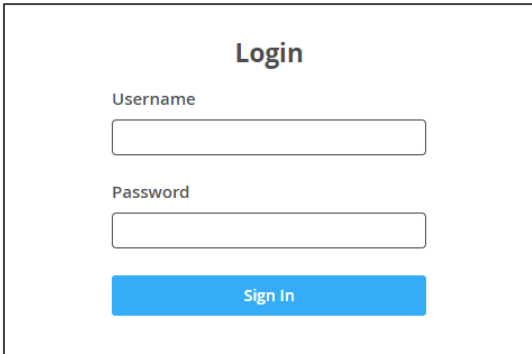

Figure 7: Login Window

- Enter the Username and Password (admin/admin, by default).
The WP-SW2-EN7 Main page (AV Routing tab) opens.

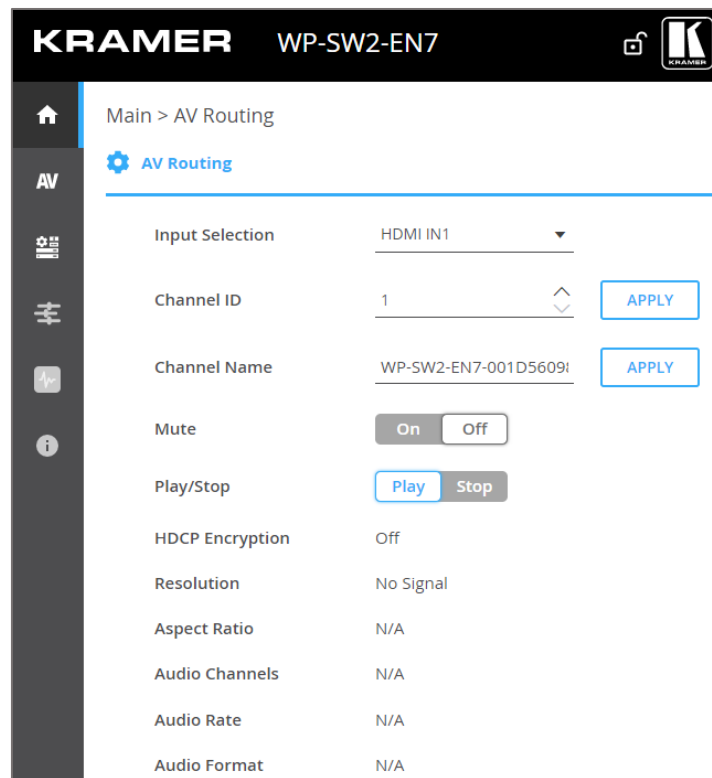



Figure 8: Controller Application Page with Navigation List on Left

- The Web UI has six pages, accessed from the Navigation menu on the left side. The Navigation menu has the following options:

 **Main** page: AV routing tab.

 **AV Settings** page: Auto Switch tab, Video tab, Audio tab and EDID tab.

 **Device Settings** page: General tab, Network tab, Time & Date tab, Security tab and Users tab.

 **Control** page: Settings tab (CEC and RS-232 parameters).

 **Diagnostics** page: Status tab, Connections tab and Advanced tab.

 **About** page.

Use the embedded web pages to perform the following actions:

- [Setting AV Routing Parameters](#) on page [17](#).
- [Activating HDCP Protection](#) on page [20](#).
- [Defining Audio Settings](#) on page [21](#).
- [Managing EDID](#) on page [22](#).
- [Defining General Settings](#) on page [23](#).
- [Defining Network Settings](#) on page [26](#).
- [Defining an NTP Time and Date Server](#) on page [29](#).
- [Setting WP-SW2-EN7 Security](#) on page [30](#).

- [Controlling User Access](#) on page [32](#).
- [Defining WP-SW2-EN7 Gateway Settings](#) on page [35](#).
- [Viewing WP-SW2-EN7 Status](#) on page [37](#).
- [Viewing WP-SW2-EN7 Connections Status](#) on page [38](#).
- [Viewing the WP-SW2-EN7 Logs](#) on page [39](#).
- [Viewing the About Page](#) on page [40](#).

Setting AV Routing Parameters

Set the WP-SW2-EN7 input port and streaming channel.

To set AV routing parameters:

1. Open the  **Main** page, (default) **AV Routing** tab.

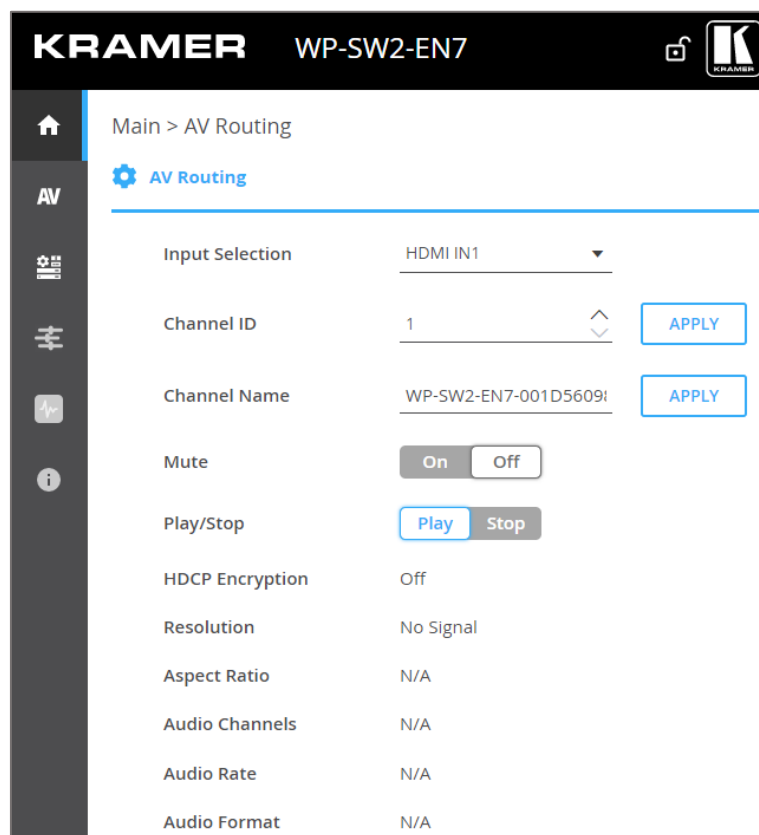

Figure 9: Controller Application Page with Navigation List on Left

2. Select an input from the drop-down box (HDMI IN1 or USB IN2).
3. Define the following settings:
 - **Channel ID:** Set Channel ID and click **APPLY**. Channel ID defines the device input ID (1 to 999).
 - **Channel Name:** Enter the Stream Name and click **APPLY**. Stream name is identical to Host name (see [Defining General Settings](#) on page [23](#)) can include up to 24 characters; “-” and “_” are allowed. The default name is the model name and MAC address connected by “-”.

- **Volume:** Use the slider to adjust the analog audio output volume (0 to 100%). Default is 80, 100% is 12dB and 0 is mute.
 - **Mute:** Mute/unmute all audio outputs (HDMI OUT and MEDIA port).
 - **Play/Stop:** Start or stop streaming of video, audio, IR, RS-232 and USB signals.
4. View the streaming parameters: HDCP Encryption (digital copyright protection), Resolution, Aspect Ratio, Audio Channels, Audio Rate and Audio Format.

AV routing parameters are defined.

Defining Switching Mode

Configure how the system switches between the input ports when both HDMI and USB-C have valid video sources.

To define auto switching settings:

1. Open the **AV** **AV Settings** page, Auto Switch tab.

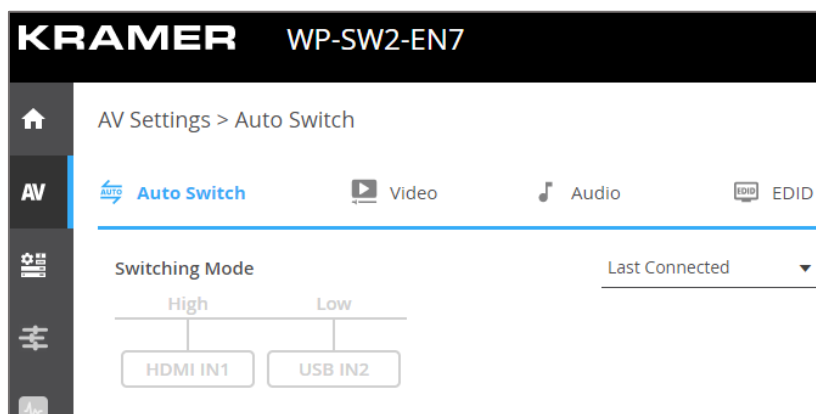

Figure 10: AV Settings Page – Auto Switch Tab

2. Set the **Switching Mode:**

- **Last Connected** (default) – **WP-SW2-EN7** streams the last used input port. The device automatically switches input if the video source is disconnected.
- **Priority** – **WP-SW2-EN7** streams the input port with the highest priority. The device automatically switches input if the video source is disconnected.
- **Manual** – The input port is set manually and does not change automatically.

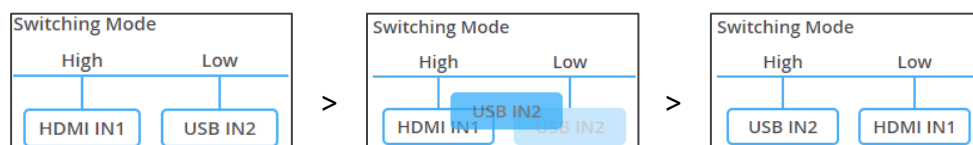

Figure 11: Setting Priority Auto Switching

3. Click **SAVE**.



If you need to reboot the device after changing the switching mode, wait at least 30 seconds. Switching mode settings will be lost if the device is rebooted less than 30 seconds after the change.

Auto switching mode is defined.

Defining Signal Loss Timeouts

Set waiting times (timeouts) for **WP-SW2-EN7** when a signal is lost or a cable is disconnected.

To define signal loss timeouts:

1. Open the **AV** **AV Settings** page, Auto Switch tab.

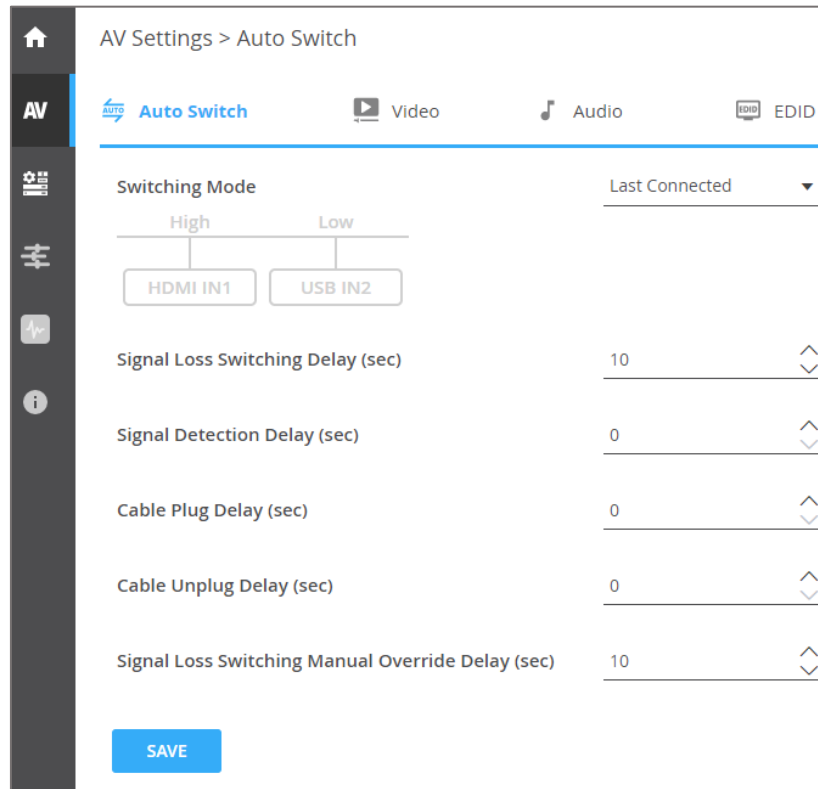

Figure 12: AV Settings Page – Auto Switch Tab

2. Set the following timeouts (in seconds):
 - **Signal Loss Switching Delay** – The length of time from when **WP-SW2-EN7** detects a signal loss, to when it switches to a different input (default 10).
 - **Signal Detection Delay** – The length of time from when **WP-SW2-EN7** detects a signal, to when it switches to that input (default 0).
 - **Cable Plug Delay** – The length of time from when **WP-SW2-EN7** detects a cable connected, to when it switches to that input (default 0).
 - **Cable Unplug Delay** – The length of time from when **WP-SW2-EN7** detects a disconnected cable to when it switches to a different input (default 0).
 - **Signal Loss Switching Power Off Delay** – The length of time from detection of a signal loss to turning off the 5V power output (default 900).
 - **Signal Loss Switching Manual Override Delay** – The length of time from manual override's signal loss to the system switching to a different input (default 10).
3. Click **SAVE**.

Signal loss timeouts are defined.

Activating HDCP Protection

High-bandwidth Digital Content Protection (HDCP) encrypts video content to prevent unauthorized copying. You can enable or disable this feature.

To activate / deactivate HDCP control:

1. Open the **AV** AV Settings page, Video tab.

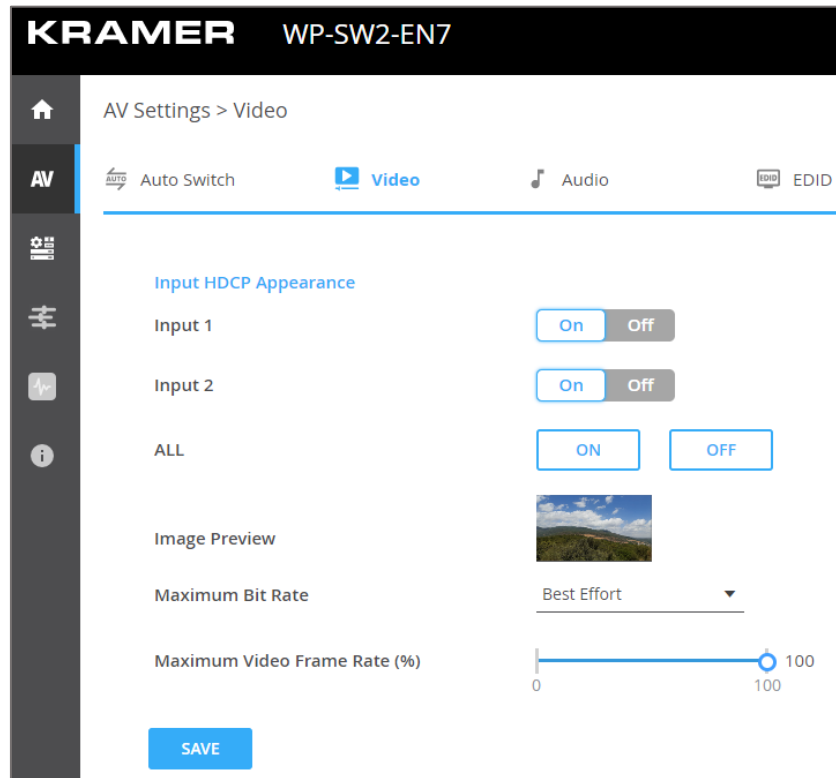

Figure 13: AV Settings Page – Video Tab

2. Define the following settings:

- **Input 1** and **Input 2:** enable (**ON**)/disable (**OFF**) HDCP support for the input port.
- **Image Preview:** shows a preview of the video stream.
- **Maximum Bit Rate:** select the maximum transmission bandwidth. Select bandwidth (10Mbps, 50Mbps, 100Mbps, 150Mbps and 200Mbps) or Best Effort (default) to set bandwidth for best video quality output, allowing the peak bandwidth to reach 850Mbps.



After setting the maximum bit rate you need to restart the device.

- **Maximum Video Frame Rate (%):** use the slider to configure the maximum frame rate in proportion. 100% (default) means zero compression on the frame rate.

3. Click **SAVE**.

HDCP protection is activated.

Defining Audio Settings

The WP-SW2-EN7 output stream can take the audio from an analog input (14) the 3.5mm mini-jack) or stream the digital audio associated with the active HDMI or USB-C input.

To define Audio settings:

1. Open the **AV** AV Settings page, Audio tab.

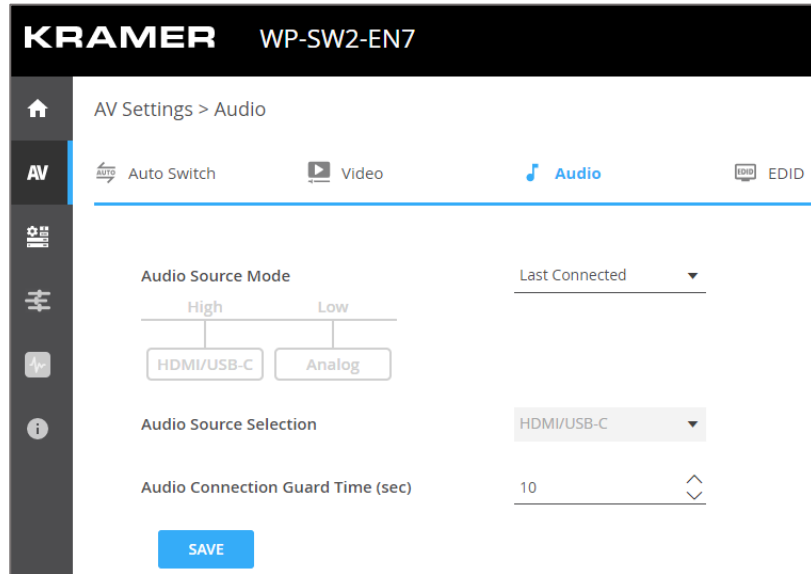

Figure 14: AV Settings Page – Audio Tab

2. Define the **Audio Source Mode** selection:

<p>Last Connected: the device uses the last connected audio source for the output stream.</p>	<p>Audio Source Mode</p> <p>High Low</p> <p>HDMI Analog</p>	<p>Last Connected ▼</p>
<p>Priority: The device uses the highest priority audio input for the output stream; set the connection priority by clicking and dragging the input.</p>	<p>Audio Source Mode</p> <p>High Low</p> <p>HDMI Analog</p>	<p>Priority ▼</p>
<p>Manual: The device does not switch the audio source unless it is manually selected in this screen or set by a Protocol 3000 command.</p>	<p>Audio Source Mode</p> <p>High Low</p> <p>HDMI Analog</p>	<p>Manual ▼</p>
	<p>Audio Source Selection</p>	<p>HDMI ▲</p> <p>HDMI</p> <p>Analog</p> <p>None</p>

3. Set the Audio Connection Guard Time (10 seconds, by default), which is the audio signal timeout period for the Last Connected or Priority modes. For example, if the active audio signal is lost (either becomes silent or is unplugged), after 10 seconds the second available audio source is automatically selected.
4. Click **SAVE**: Audio settings are updated.

Managing EDID

Extended Display Identification Data (EDID) are used by video transmitters to define the display device capabilities. This information may be transmitted by display devices. **WP-SW2-EN7** can manually load a specific EDID definition and can be locked to that EDID definition.

To manage EDID:

1. Open the **AV** **AV Settings** page, EDID tab.

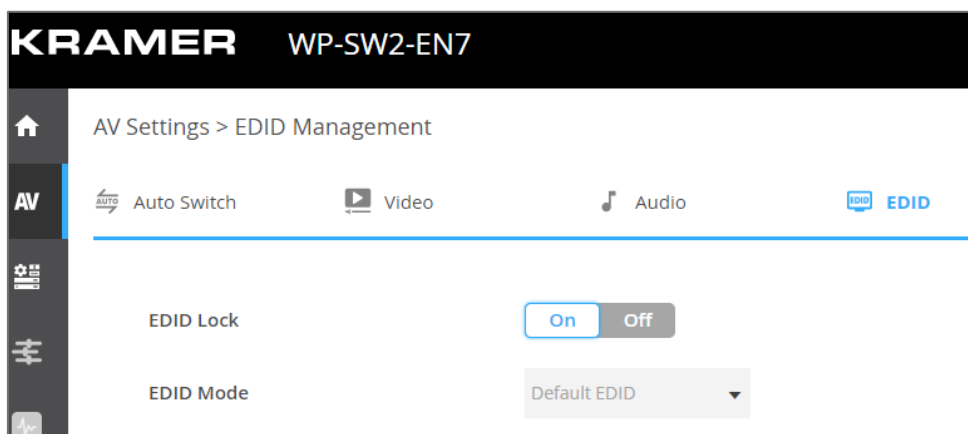

Figure 15: AV Settings Page – EDID Management Tab

2. Set the EDID Lock:
 - Click **ON**, to lock to the last acquired EDID.
 - Click **OFF**, to unlock and acquire a new EDID.

3. After setting the **EDID Lock** to OFF, select an **EDID Mode** from the drop-down box:

Default EDID: Use the default built-in EDID.

EDID Lock: On Off

EDID Mode: Default EDID

Passthrough: Acquire the EDID from a specific decoder:

- Enter the decoder's IP address.
- Click **READ**.

The EDID is copied from the decoder to the encoder.

EDID Lock: On Off

EDID Mode: Passthrough

Read EDID from Specific Decoder: 0.0.0.0 READ

Custom: download the EDID file from an external source.

To remove an EDID from the list:

- Select an EDID file from the list.
- Click **REMOVE**.

To upload an EDID file:

- Click **UPLOAD**.
- Select an EDID file from the Open window.
- Click **UPLOAD**. the EDID file is added to the list.
- Select the file and click **UPLOAD**.

EDID Mode: Custom

User EDID:

- default.bin
- 4K30_2.0CH_SDR.bin
- 4K30_Dolby_DTS7.1_SDR.bin
- 1080P50_Dolby_DTS7.1_SDR.bin
- 720P50_2.0CH_SDR.bin
- 720P50_Dolby_DTS7.1_SDR.bin

UPLOAD REMOVE APPLY



You can load up to 8 EDID files. If 8 files are loaded, you need to remove a file from the list. default.bin cannot be deleted.

The list returns to its default list upon factory reset.

Defining General Settings

The  **Device Setting** page's (default) **General** tab enables performing the following actions:

- [Changing the Device's Host Name](#) on page [23](#).
- [Hiding the Channel Number on the Front Panel](#) on page [24](#).
- [Importing/Exporting Device Settings](#) on page [24](#).
- [Locating the Device \(making the LEDs flash\)](#) on page [25](#).
- [Managing the Firmware](#) on page [25](#).
- [Restarting or Resetting the Device](#) on page [26](#).

Changing the Device's Host Name

To change the device's network ID (also known as the host name):

1. Open the **General** tab of the  **Device Setting** page.

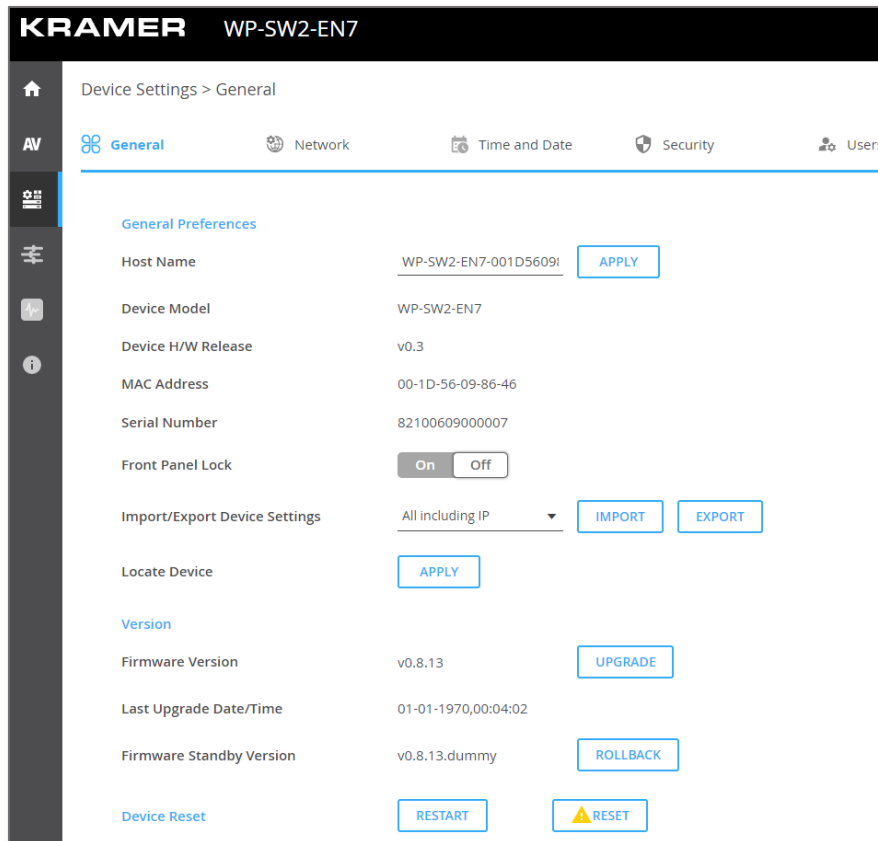

Figure 16: Device Settings – General Tab

2. Enter a new Host Name and click **Apply**.

The Host Name has a maximum 24 characters and can include the special characters hyphen “-” and underscore “_”, but not at the start or end of the name.

The default host name is **WP-SW2-EN7-xxxxxxxxxxxx** (“xxxxxxxxxxxx” = MAC address).

Host name is changed.

Hiding the Channel Number on the Front Panel

The front panel display (8) of the **WP-SW2-EN7** shows the ethernet channel number on which the video is streamed. The display can be locked, hiding the channel number from users.

To hide the channel number:

1. Open the **Device Settings** page, General tab.
2. Set **Front Panel Lock** to ON.

The channel number is no longer visible on the front panel.

Importing/Exporting Device Settings

Device settings can be exported to a backup file and uploaded to the device. Settings are imported/exported in a series of JSON files zipped into a single tar.gz file. Use the **Export** button to output examples.

To export the device settings:

1. Open the  **Device Setting** page's (default) **General** tab.
2. Select the type of information you want to export or import:
 - **All without IP** – Outputs all the settings, including the logs but without network settings.
 - **Streams** – Outputs the content of the channel definitions set on the Main page, AV Routing tab.
 - **AV Settings Only** – Outputs the content of the AV Settings page: Auto-Switch, Video, Audio and EDID tabs.
 - **All including IP** – Outputs all the settings including the logs and network settings.

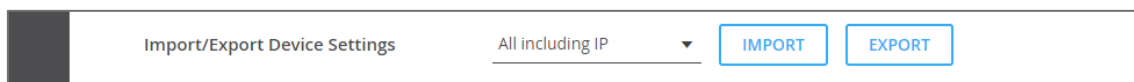



Figure 17: Device Settings page – Import/Export Device Settings

3. Click **Export** to output a list of JSON files compressed into a single **tar.gz** file.
Device settings exported.

Locating the Device (making the LEDs flash)

To make the LEDs on the **WP-SW2-EN7** front panel flash for 60 seconds, so that you can identify the device:

1. Open the  **Device Setting** page's default **General** tab.
2. Click **Apply** on the **Locate Device** field.

The LEDs flash for 60 seconds and device is located.

Managing the Firmware

To view or upgrade the firmware version:

1. Open the  **Device Setting** page's default **General** tab.
2. Click **Upgrade** to run a firmware upgrade. For a detailed procedure, see [Upgrading Firmware](#) on page [41](#).

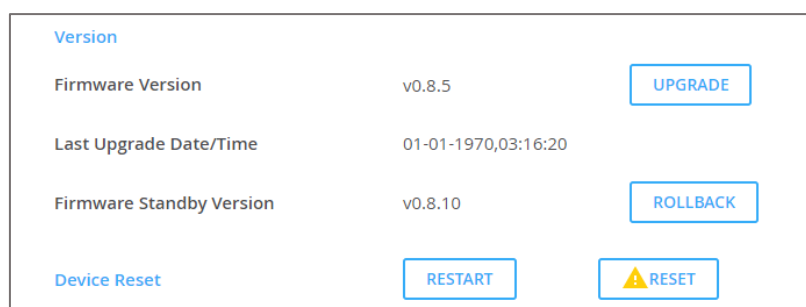

Figure 18: Device Settings Page – Firmware

3. The system saves the **Last Upgrade Date/Time** and previous firmware version (the **Standby Version**) in memory:
 - Click **Rollback** to roll back the firmware to the last loaded version.

For example, if the current firmware version is v0.8.5, and the standby version is v0.8.10; After “Rollback”, the device will update the firmware to the v0.8.10 version.

4. Click **RESTART** to reboot the device and activate the firmware.
Firmware is managed.

Restarting or Resetting the Device

To reboot the device or restore it to default factory settings:

1. Open the  **Device Setting** page's default **General** tab.
2. Next to Device Reset:
 - Click **RESTART** to reboot the device.
 - Click **RESET** to restore default factory settings.
3. Refresh the page to see the new settings.

Device is restarted / reset.

Defining Network Settings

The  **Device Settings** page, **Network Settings** tab controls the Ethernet port and IP settings of the WP-SW2-EN7 and provides the following capabilities:

- [Using the Service Port for P3K & Gateway transmissions](#) on page [26](#).
- [Defining IP Casting Mode Setting and TTL](#) on page [28](#).
- [Managing TCP/UDP Ports](#) on page [28](#).

Using the Service Port for P3K & Gateway transmissions

WP-SW2-EN7 has two Ethernet ports (SERVICE 1G and MEDIA 1G). By default, all network connections go to the MEDIA port with DHCP enabled and 802.1Q disabled.

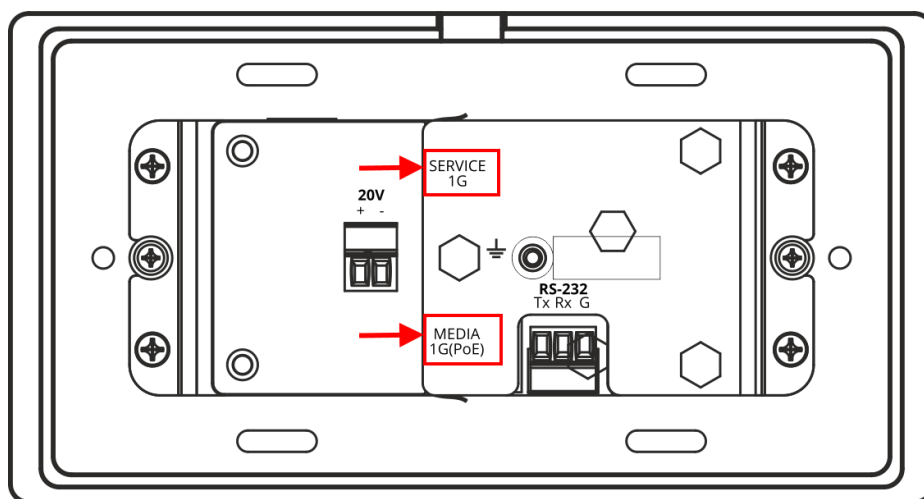

Figure 19: Ethernet Ports on the Rear of the WP-SW2-EN7

WP-SW2-EN7 can use the Service port (with a separate IP address) for P3K & Gateway traffic. Video and other types of streaming always use the MEDIA port.

To separate P3K & Gateway from the AV streams:

1. Open the  **Device Setting** page's default General tab and select the **Network** tab.

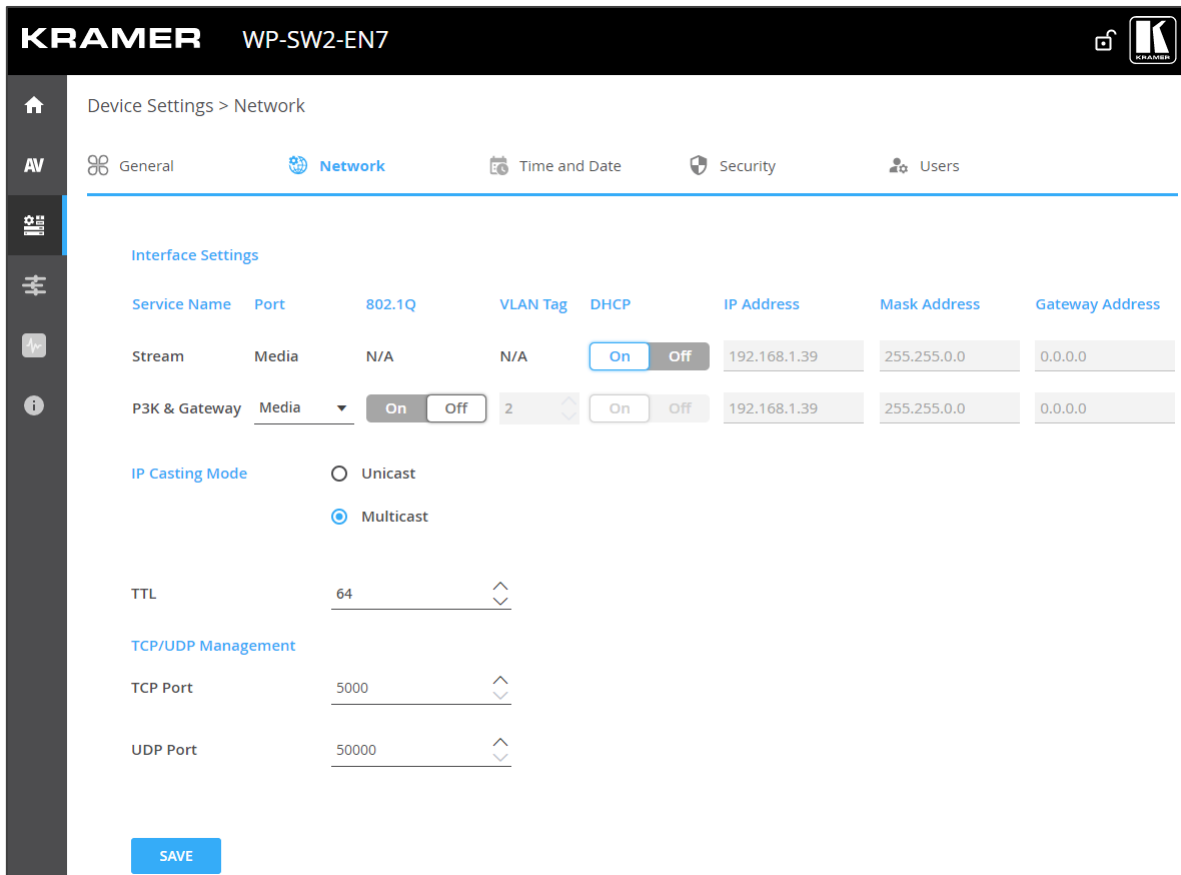



Figure 20: Device Settings Page – Network Tab

2. Change the following settings in the **Interface Settings** section of the **Network** tab (**Device Settings** page):

- In the **Port** column select **Service** and set **802.1Q** to **On**.
- In the **VLAN ID** column, enter an integer number (2 – 4093) for P3K & Gateway services.
This separates the P3K & Gateway packets.

 802.1Q and VLAN are not required for the Media port.

3. If you want the P3K & Gateway port to have a static IP, set DHCP to **Off** and enter a subnet mask and gateway address.
If there is no valid DHCP server in the system, it will look for the random unique IP in the range of 169.254.X.Y. The allocated IP address is shown in the IP address field.

4. Click **SAVE**.
a RESTART Message appears. Click **RESTART** to apply the change.

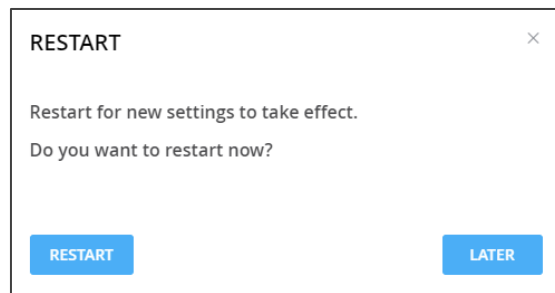

Figure 21: Device Settings Page – RESTART Message

Gateway and p3K are separated from AV streams.

Defining IP Casting Mode Setting and TTL

The **IP Casting Mode** is set by the Encoder. The setting on this field needs to be the same as that on the encoder:

- **Unicast** – The encoded stream is intended for a specific decoder.
- **Multicast** (default) – Any decoder can access the encoded stream.

TTL (time to live) limits the lifetime of the streamed data in the computer network. It prevents the IP packet from propagating endlessly through the network. The default value is 64, which means that after 64 hops the data packet is dropped.

To define casting mode and TTL:

1. Open the  **Device Setting** page's default General tab and select the **Network** tab.
2. In the IP casting area, check **Unicast** or **Multicast** (default) mode.
3. Set TTL (default, 64).
4. Click **SAVE**.
a RESTART Message appears (see [Figure 21](#)). Click **RESTART** to apply the change.

IP Casting and TTL are defined.

Managing TCP/UDP Ports

TCP and UDP are protocols that define how data is streamed. The port on which the data is received must be defined in the system.

To manage TCP and UDP ports:

1. Open the  Device Settings page, Network tab.
2. Set TCP/UDP port number.
The default values are **TCP Port** – 5000 and **UDP Port** – 50000.
3. Click **SAVE**.
a RESTART Message appears (see [Figure 21](#)). Click **RESTART** to apply the change.

TCP/UDP ports are managed.

Defining an NTP Time and Date Server

You can sync the device time and date to a network time protocol (NTP) server.

To sync device time and date to a server:

1. Open the  **Device Settings** page, **Time and Date** tab.

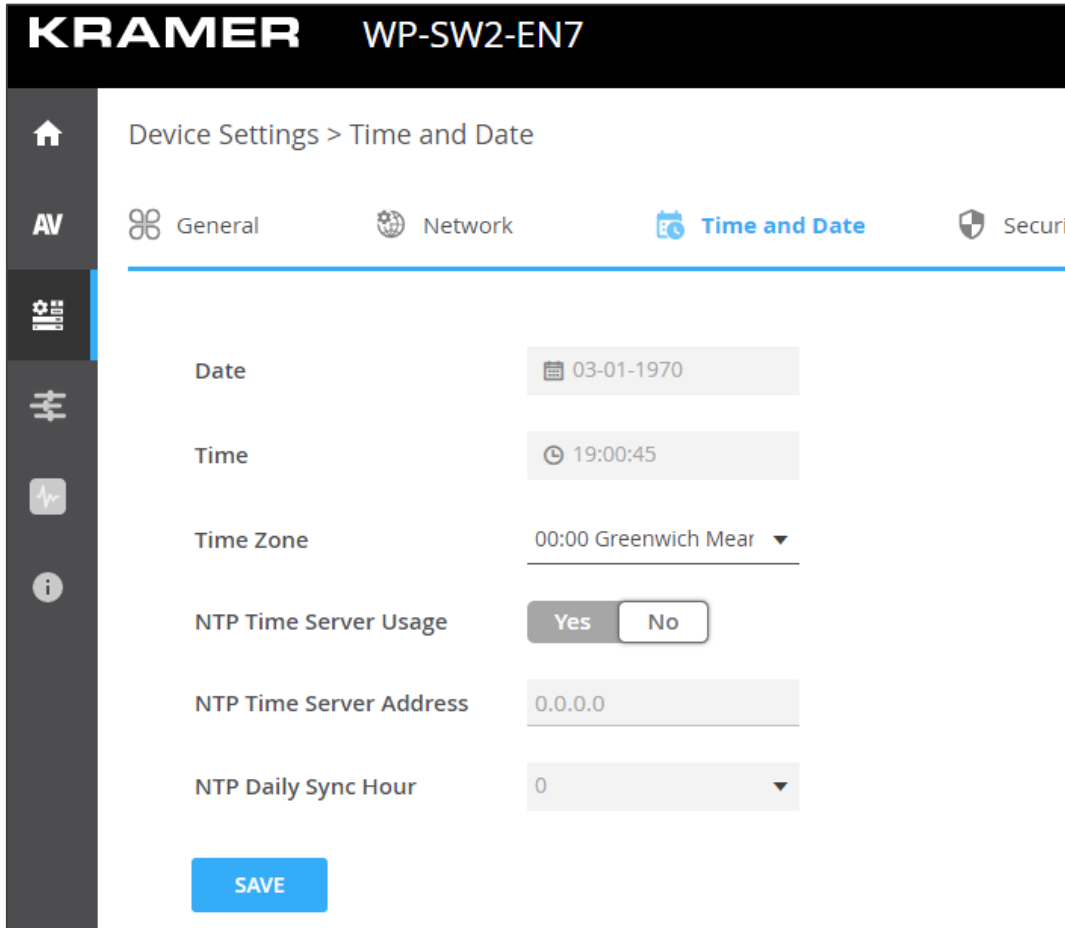

The screenshot shows the 'Time and Date' configuration page for a Kramer WP-SW2-EN7 device. The page has a dark header with the Kramer logo and device ID. A sidebar on the left contains navigation icons. The main content area has a breadcrumb 'Device Settings > Time and Date' and tabs for 'General', 'Network', 'Time and Date', and 'Security'. The 'Time and Date' tab is active. The settings are as follows:

Date	03-01-1970
Time	19:00:45
Time Zone	00:00 Greenwich Mean
NTP Time Server Usage	Yes (selected) / No
NTP Time Server Address	0.0.0.0
NTP Daily Sync Hour	0

A blue 'SAVE' button is located at the bottom of the settings area.

Figure 22: Device Settings Page – Time and Date Tab

2. Set **NTP Time Server Usage** to **Yes**. This enables the NTP fields.
3. Enter the NTP time server address and set a daily sync hour.
4. Click **SAVE**.

The date and time are synchronized to the time server.

Setting WP-SW2-EN7 Security

The  **Device Settings** page's Security tab enables HTTPS/TLS to encrypt communication with authenticated peers over the network and enables 802.1x authentication to prevent unauthorized access.

This section describes the following actions:

- [Configuring HTTPS](#) on page [30](#).
- [Defining 802.1x Authentication](#) on page [31](#).



Contact your IT administrator for the network access authentication.

Configuring HTTPS

HTTPS encrypts communication with the **WP-SW2-EN7**.

To configure HTTPS:

1. Open the  **Device Settings** page, **Security** tab.

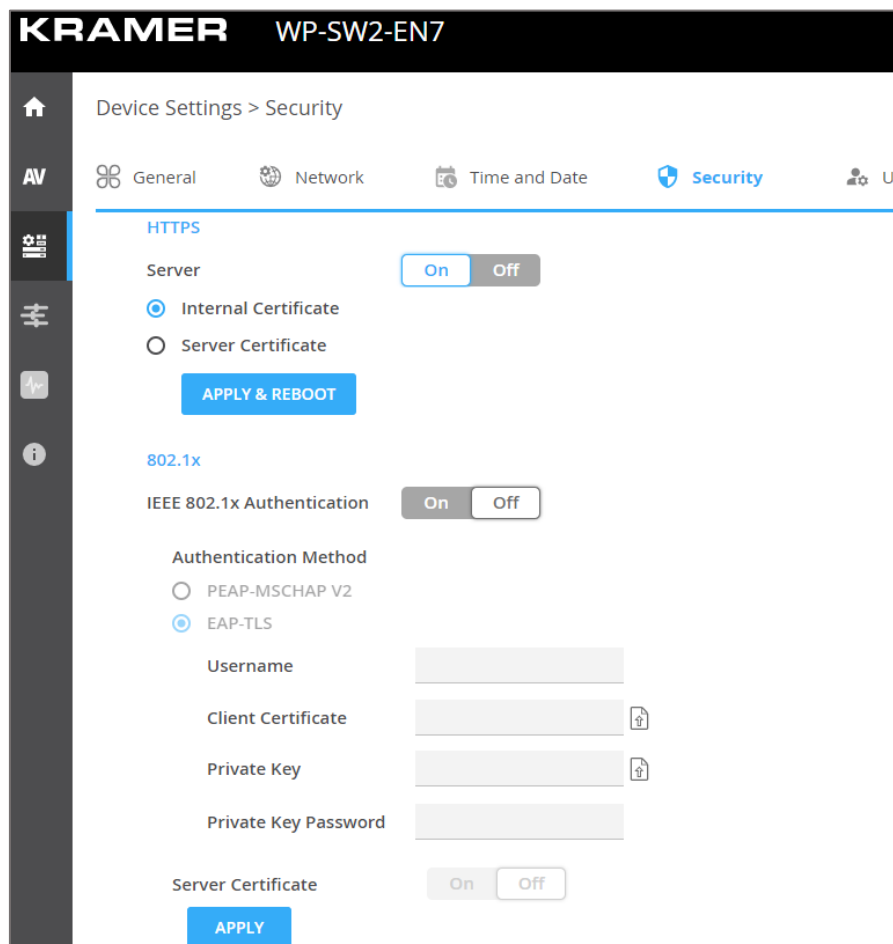



Figure 23: Device Settings Page – Security Tab

2. For HTTPS server, click **On** to enable HTTPS authentication service (default) or **Off** to disable HTTPS authentication.

3. When set to On, select one of the following:
 - **Internal Certificate** – To use the factory default certificate for authentication.
 - **Server Certificate** – To submit a certificate from the server for authentication. To do so, click  to upload the certificate. Enter the private key password (assigned by the IT administrator).

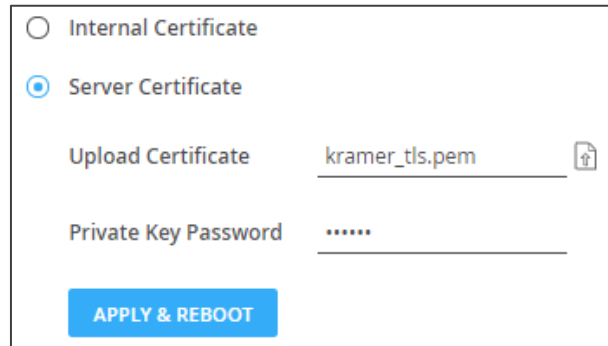



Figure 24: Security Tab – Server Certificate

4. Click **APPLY & REBOOT**.

HTTPS is configured.

Defining 802.1x Authentication

To configure security for the WP-SW2-EN7:

1. Open the  **Device Settings** page, **Security** tab.
2. Click **ON** to enable the 802.1x authentication service. 802.1x supports authentication based on port and MAC address.
3. Select one of the following:
 - **PEAP-MSCHAP V2** – Enter a Username (up to 24 alphanumeric characters, including “_” and “-” characters within the username) and Password (up to 24 ASCII characters):

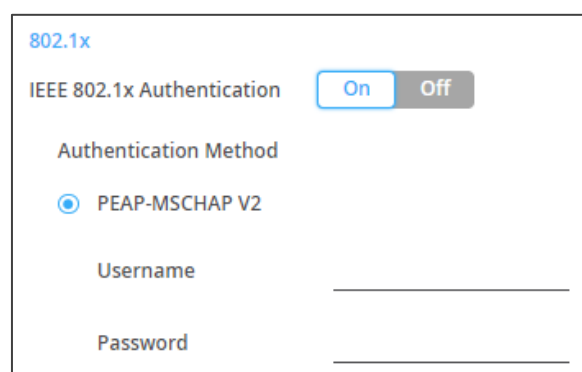



Figure 25: Security Tab – EAP-MSCHAP V2 Authentication

- **EAP-TLS** – Enter a Username, click  to upload the certificates and keys and enter the private key password (assigned by IT administrator).

4. Set Server Certificate **On**.

802.1x

IEEE 802.1x Authentication On Off

Authentication Method

PEAP-MSCHAP V2

EAP-TLS

Username _____

Client Certificate _____ 

Private Key _____ 

Private Key Password _____

Server Certificate On Off

Figure 26: EAP-TLS – Certificates and Password

5. Click **APPLY**.

Security is configured.

Controlling User Access

The  **Device Settings, Users** tab activates password-based device security and inactivity locking on the **WP-SW2-EN7**, preventing unauthorized access to the embedded web pages. The default password is **admin** (the user is always "admin"). By default, this security is disabled.

- [Activating Password-Based Device Security](#) on page [33](#).
- [Inactivity Locking](#) on page [34](#).
- [Changing the Password](#) on page [34](#).

Activating Password-Based Device Security

To enable password-based device security:

1. Open the  **Device Settings** page, **Security** tab.



Figure 27: Device Settings Page – Users Tab

2. Set **Security Status** to On (Off by default). The following message appears.

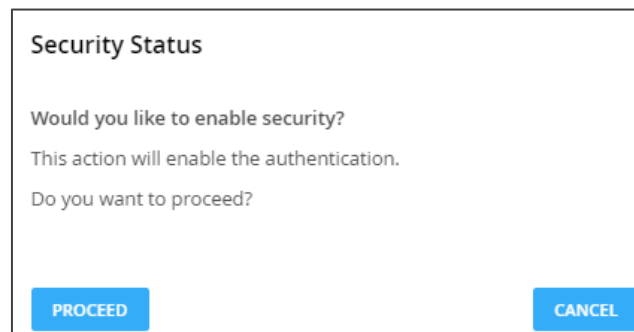



Figure 28: Security Tab – Security Status

3. Click **PROCEED** and enter a password. The default user is "admin" and the default password is "admin".

Security is enabled and access requires authentication.

Changing the Password

To change the password:

1. Open the  **Device Settings** page, **Security** tab.
2. Set **Security Status** to On (this activates password use).

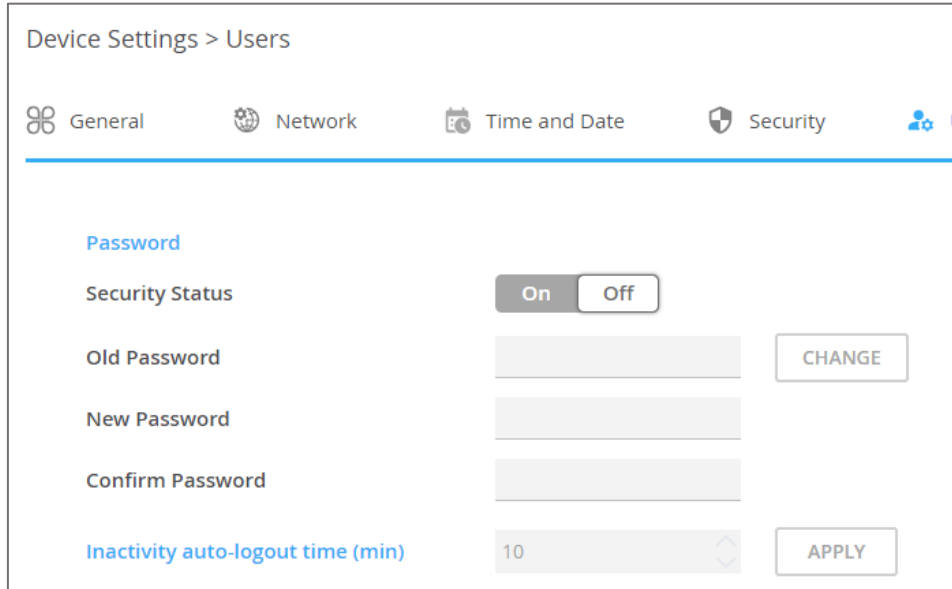

The screenshot shows the 'Device Settings > Users' interface. At the top, there are navigation tabs: General, Network, Time and Date, Security (selected), and Users. Below the tabs, the 'Password' section is visible. It includes a 'Security Status' toggle switch currently set to 'On'. Below this are three input fields: 'Old Password', 'New Password', and 'Confirm Password'. To the right of the 'Old Password' field is a 'CHANGE' button. At the bottom of the section, there is an 'Inactivity auto-logout time (min)' dropdown menu set to '10' and an 'APPLY' button.

Figure 29: Device Settings – Users Tab

3. Enter the **Old Password** and the **New Password**.

 The new password must include at least one number, one special character (excluding spaces or commas), one uppercase and one lowercase letter and should be 8 to 24 characters long.

4. **Confirm** the new password.
5. Click **CHANGE**.

The password has changed.

Inactivity Locking

Set the Inactivity auto-logout time (in minutes), to cause the page to log out automatically. This option requires password-controlled access to the embedded web-pages (Security Status set to On). The default password is **admin** (the user is always "admin").

To set inactivity locking:

1. Open the  **Device Settings** page, **Security** tab.
2. Set **Security Status** to On (this activates password use).

By default, the device locks after 10 minutes. If necessary, enter a new time in minutes.

Defining WP-SW2-EN7 Gateway Settings

WP-SW2-EN7 enables configuring CEC or RS-232 gateway Control. You can perform the following actions:

- [Configuring CEC Settings](#) on page [35](#).
- [Configuring RS-232 Settings](#) on page [36](#).

Configuring CEC Settings

Consumer Electronics Control (CEC) is a feature of HDMI that enables users of remote devices to control them from a single source. WP-SW2-EN7 can send CEC commands to remote devices connected to the decoder, via the WP-SW2-EN7 built-in control gateway.

To set the CEC Gateway:

1. Open the  **Control** page (Settings tab).

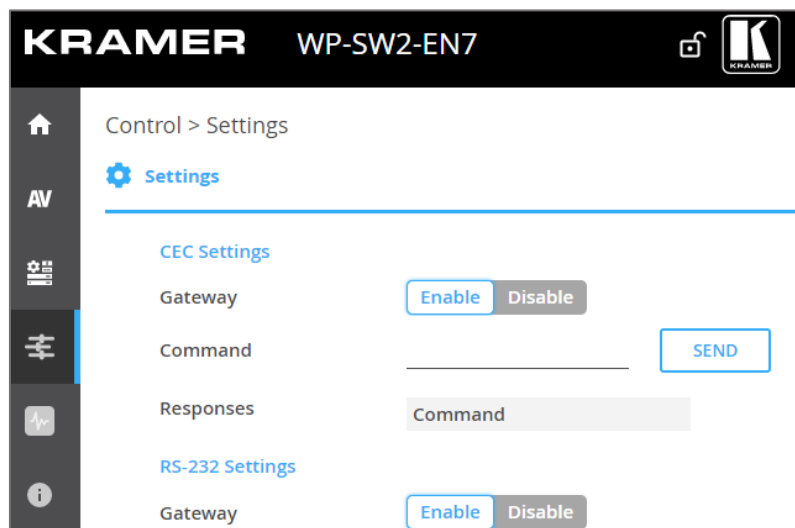

Figure 30: Control > Settings Page – CEC Settings

2. **Enable** the CEC gateway.
3. Enter a CEC command in hex format, up to 32 hex digits.
4. Click **SEND**.
5. View the CEC-enabled device response.

CEC Gateway is configured.

Configuring RS-232 Settings

Control systems connected by LAN to the **WP-SW2-EN7**, can transmit RS-232 commands to devices connected to the **WP-SW2-EN7** RS-232 port. The RS-232 Gateway must be enabled for this feature.

To set RS-232 Gateway:

1. Open the  **Control** page, (default) Settings tab.

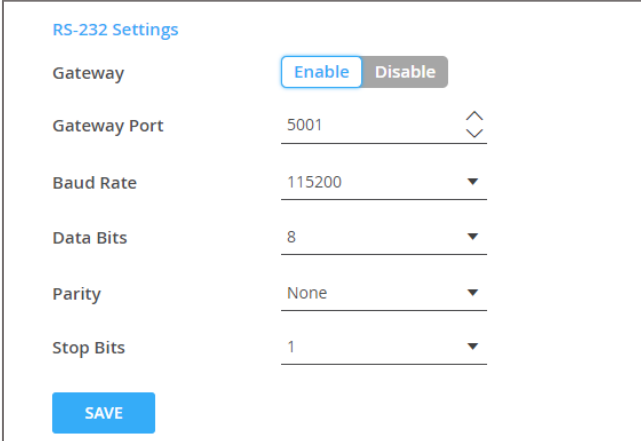

RS-232 Settings	
Gateway	<input checked="" type="button" value="Enable"/> <input type="button" value="Disable"/>
Gateway Port	5001 <input type="button" value="^"/> <input type="button" value="v"/>
Baud Rate	115200 <input type="button" value="v"/>
Data Bits	8 <input type="button" value="v"/>
Parity	None <input type="button" value="v"/>
Stop Bits	1 <input type="button" value="v"/>
<input type="button" value="SAVE"/>	

Figure 31: Control > Settings Page – RS-232 Settings

2. **Enable** the RS-232 Settings **Gateway**.
3. Set the RS-232 **Gateway Port** (5001, by default).
4. Enter the **Baud Rate**: 9600, 19200, 38400, 57600 or 115200 (default).
5. Enter the **Data Bits**: 5, 6, 7 or 8 (default).
6. Enter **Parity**: None (default), Odd or Even.
7. Enter **Stop Bits**: 1 (default) or 2.
8. Click **SAVE**.

RS-232 Gateway is configured.

Viewing WP-SW2-EN7 Status

The  **Diagnostics** page's **Status** tab displays general status information for the device:

To view the device status:

1. Open the  **Diagnostics page**, the (default) Status tab appears.

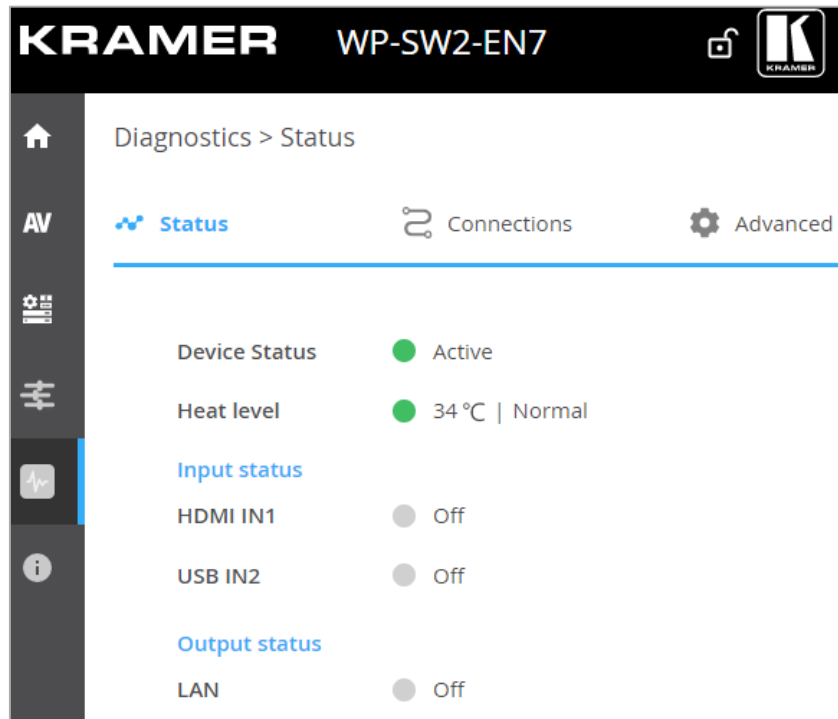

Figure 32: Diagnostics – Status Tab

2. View the device status:
 - **Active**, for normal operation (green circle).
 - **Standby**, device is powered Off, booting or in standby mode (yellow circle).
3. View the device's heat status:
 - **Normal**, for temperatures under 45°C (green circle).
 - **High**, for temperatures between 45°C and 60°C (orange circle).
 - **Overheat**, for temperatures higher than 60°C (red circle).
4. View the status of each input port:
 - **On**, when the input has a valid signal and is transmitting a signal (green circle).
 - **Off**, when an input is not connected or there is no valid signal (gray circle).
5. View the LAN output status:
 - **On**, when the LAN is transmitting a signal (green circle).
 - **Off**, when the LAN has no signal output (gray circle).

Device status is viewed.

Viewing WP-SW2-EN7 Connections Status

View the IP addresses of the devices connected to the WP-SW2-EN7.

To view Connections status:

1. Open the  **Connections** page, Connections tab.

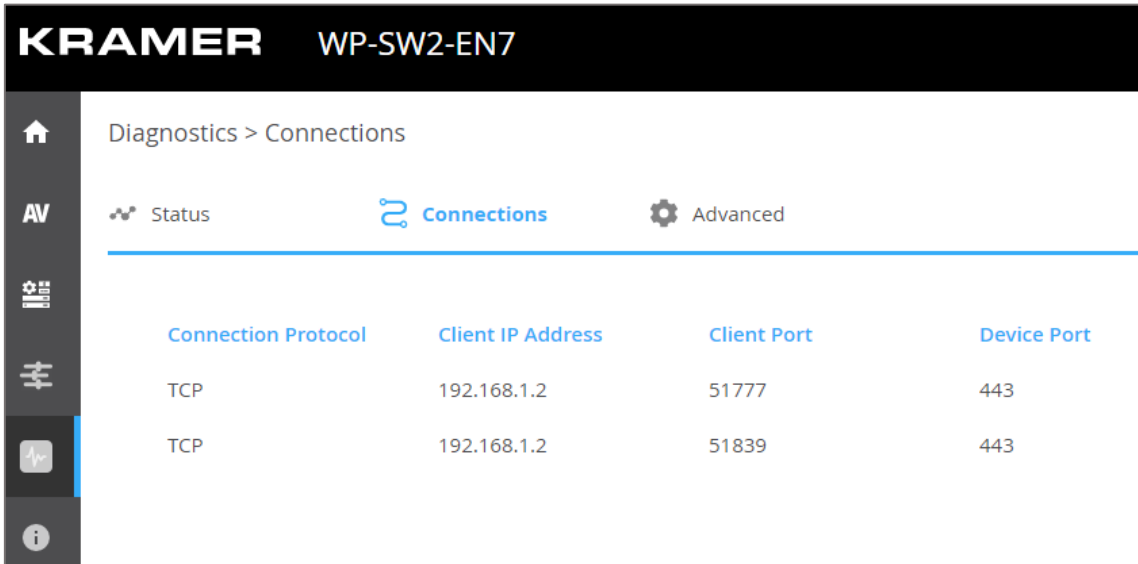

Connection Protocol	Client IP Address	Client Port	Device Port
TCP	192.168.1.2	51777	443
TCP	192.168.1.2	51839	443

Figure 33: Diagnostics – Status Tab

2. View the active connections, including the communication protocol, client's IP address and port, and the device port.

You have viewed the IP connections.

Viewing the WP-SW2-EN7 Logs

View the system log and gateway messages counter.

To view the log and a count of RS-232 and CEC messages:

1. Open the  **Diagnostics page**, Advanced tab.

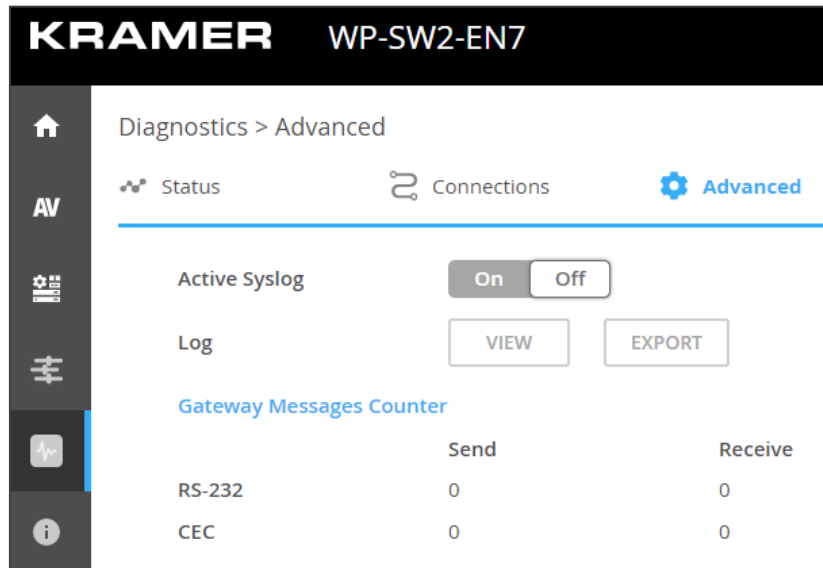

Figure 34: Diagnostics – Advanced Tab

2. To activate the log:
 - **On**, enables the **WP-SW2-EN7** system log.
 - **Off** (default), disables the system log.
3. Click **VIEW** to view the system log online.
4. Click **EXPORT** to copy the system log to a (.txt) file.
5. View the **Gateway Messages Counter** to see a count of the RS-232 or CEC Messages. This shows the number of sent and received RS-232 and CEC messages.

Viewing the About Page

The **i** **About** page shows the device model name, the hardware version, the firmware version and the Kramer Electronics Ltd details.

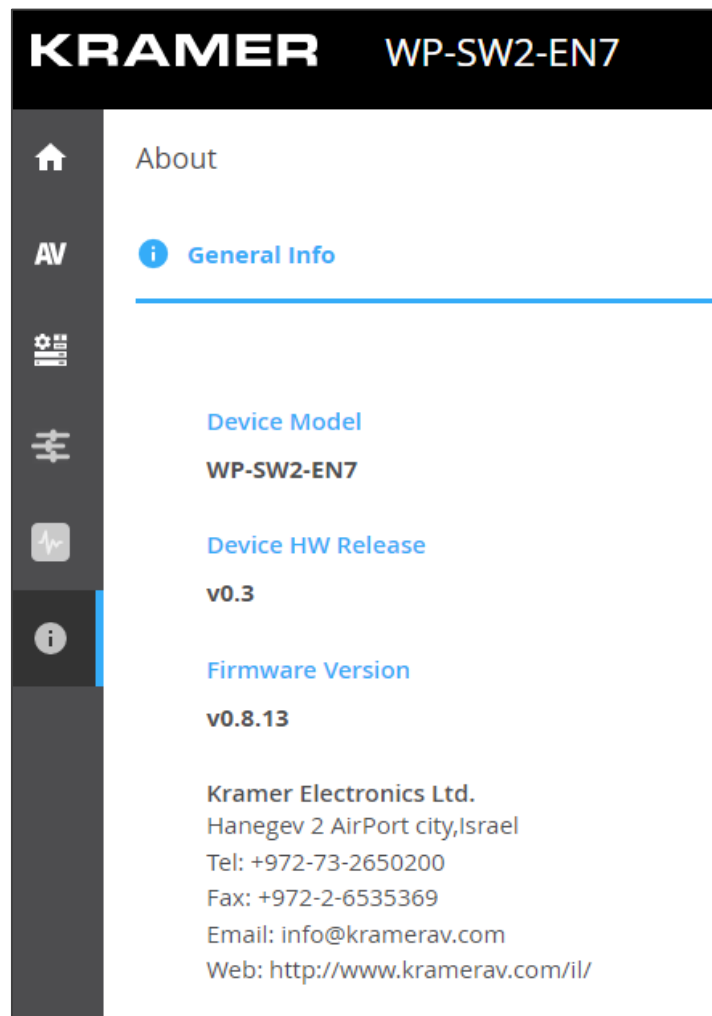

Figure 35: About Page

Upgrading Firmware

Upgrade the firmware, view the date of the last upgrade, or rollback to the previous firmware revision in case of a problem.



Click **ROLLBACK** to update to the previous FW version.



If the device firmware version is lower than 0.6.3, contact Kramer tech support team at support@kramerav.com or go to our Web site at k.kramerav.com/support/downloads.asp.

To upgrade the firmware:

1. Open the **Device Setting** page's default **General** tab.

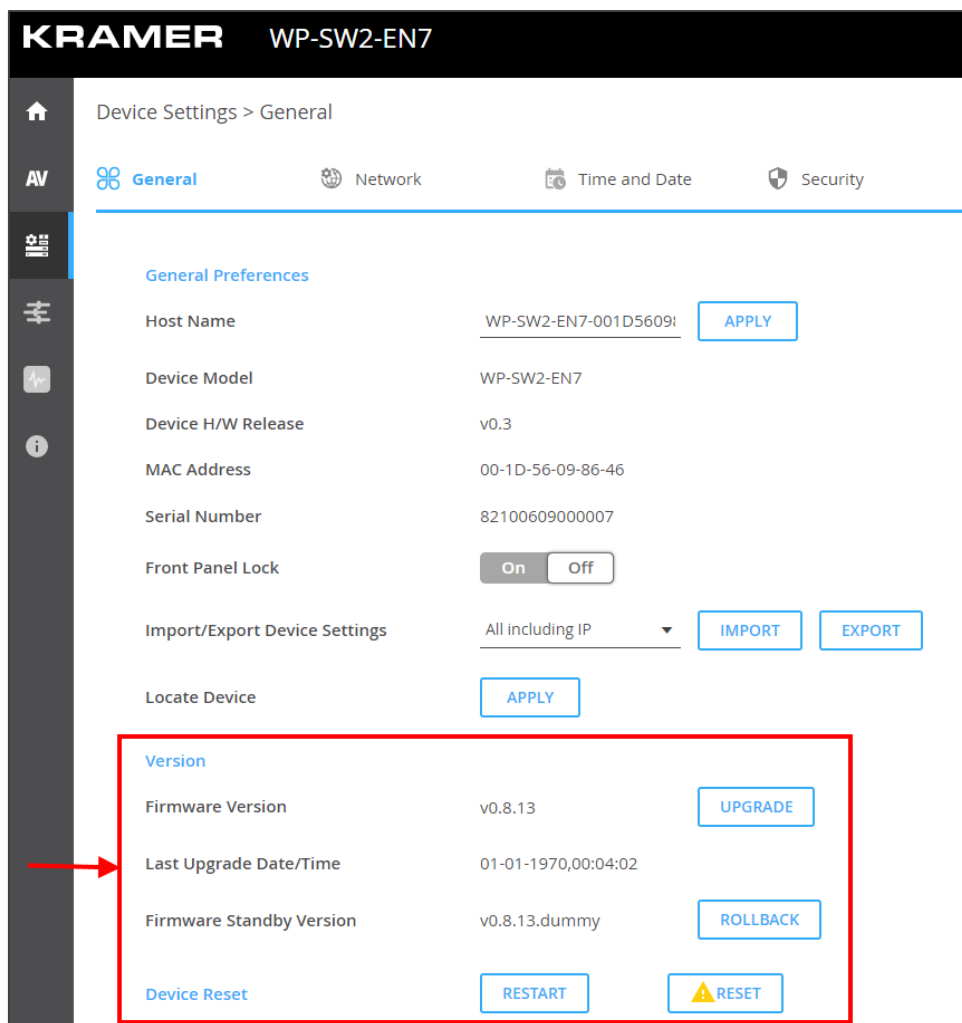

Figure 36: General Tab – Upgrading the Firmware

2. In the **Version** section, click **UPGRADE**. The Open window appears.
3. Select the firmware file and click **Open**. The firmware upgrade pop-up window appears. Wait for upgrade completion.
4. Once completed, refresh the web page and log-In.

The Firmware is updated.

Technical Specifications

Inputs	1 HDMI	On a female HDMI connector
	1 USB	On a USB-C connector
	1 Audio	On a female 3.5mm mini jack
Ports	2 Ethernet	On RJ-45 female connectors
	1 RS-232	On a 3-pin terminal block connector
Video	Compression Standard	JPEG based, private stream
	Max Resolution	4K@60Hz (4:2:0) or 3K@30 (4:4:4)
Audio	Supported Formats	LPCM upto 7.1/24-bit/192kHz Dolby Atmos™, Dolby TrueHD, Dolby Digital Plus™, Dolby Digital EX, Dolby Digital 5.1, Dolby Digital 2/0 Surround, Dolby Digital 2/0 DTS-HD Master Audio™, DTS-HD, DTS-ES Discrete 6.1, DTS-ES Matrix 6.1, DTS Digital Surround 5.1
User Interface	Indicators	HDMI, USB and ON LEDs, front panel channel display.
	Recessed Buttons	CH+, CH- and factory reset button
Power	PoE	37V to 57V, maximum power consumption 12W
	Optional power supply	20V DC, 6A Max.
Environmental Conditions	Operating Temperature	0° to +45°C (32° to 113°F)
	Storage Temperature	-20° to +70°C (-4° to 158°F)
	Humidity	10% to 90%, RHL non-condensing
Regulatory Compliance	Safety	CE, FCC
	Environmental	RoHs, WEEE
Enclosure	Size	2 Gang
	Type	SGCC (galvanized steel) and PC (polycarbonate)
	Cooling	Convection Ventilation
Dimensions	EU & UK Net Dimensions (H, W, D)	15.1cm x 4.6cm x 8.6cm (5.9" x 1.8" x 3.4")
	US Net Dimensions (H, W, D)	12.1cm x 4.6cm x 12.1cm (4.8" x 1.6" x 4.5")
	EU & UK Shipping Dimensions (W, D, H)	23.8cm x 13.7cm x 7.5cm (9.4" x 5.4" x 2.95")
	US Net Dimensions (W, D, H)	20cm x 13.7cm x 7.5cm (7.9" x 5.4" x 2.95")
Weight	Net Weight	EU version: 0.42kg (0.9lb) approx. US version: 0.44kg (0.97lb) approx.
	Shipping Weight	EU version: 0.65 (1.4lb) approx. US version: 0.7 (1.5lb) approx.
Specifications are subject to change without notice at www.kramerav.com		

Default Communication Parameters

P3K	
Example (stop encoder decoder activity)	#KDS-ACTION 0<CR>
Ethernet	
Opens the embedded webpage's Main page, (default) AV Routing tab.	
DHCP	Default
IP Address:	192.168.1.39
Subnet mask:	255.255.0.0
Default gateway:	0.0.0.0
TCP Port #:	5000
UDP Port #:	50000
Default username:	admin
Default password:	admin
Full Factory Reset	
Embedded web pages	Device Settings > General > RESET
Front panel buttons	Press the recessed RESET button on the front panel for 10 seconds. On the US model, access to this button requires removal of the frame.

Default EDID

Block 0

	0	1	2	3	4	5	6	7	8	9	A	B	C	D	E	F
00	00	FF	FF	FF	FF	FF	FF	00	2D	B2	00	00	01	00	00	00
10	25	1F	01	03	80	59	32	78	0A	EE	91	A3	54	4C	99	26
20	0F	50	54	21	08	00	81	00	A9	C0	01	01	01	01	01	01
30	01	01	01	01	01	01	02	3A	80	D0	72	38	2D	40	10	2C
40	45	80	20	C2	31	00	00	1E	E7	31	80	A0	70	B0	1D	40
50	30	20	36	00	59	32	00	00	00	1A	00	00	00	F7	00	0A
60	00	4A	A2	24	02	00	00	00	00	00	00	00	00	00	00	FC
70	00	4B	44	53	37	20	45	6E	63	6F	64	65	72	0A	01	36

Block Type: Base EDID

Checksum verified

Version 1 header verified

Manufacturer: KMR

Product Code: 0 (0000h)

Serial #: 1 (00000001h)

Date of Manufacture: Week 37 of 2021

EDID Version 1, Revision 3

Number of additional blocks: 1

Basic Display Parameters and Features

•Video Input Definition: Digital
VESA DFP 1.x Compatible (1.3)

Horizontal Screen Size: 89 cm

Vertical Screen Size: 50 cm

Display Transfer Characteristics (Gamma) 2.20

Active off: No

Suspend: No

Standby: No

RGB color display

sRGB is not used as default

Preferred Timing is native

Display is non-continuous frequency (multi-mode)

Chromaticity

Red: (0.640, 0.330)

Green: (0.300, 0.600)

Blue: (0.150, 0.060)

White: (0.313, 0.329)

Established Timings I

640 x 480 @ 60Hz

800 x 600 @ 60Hz

Established Timings II

1024 x 768 @ 60Hz

Manufacturer's Timings:

None

Standard Timings

Timing 1: 1280 x 800 @ 60 Hz (16:10)
 Timing 2: 1600 x 900 @ 60 Hz (16:9)
 Timing 3: Not Used
 Timing 4: Not Used
 Timing 5: Not Used
 Timing 6: Not Used
 Timing 7: Not Used
 Timing 8: Not Used

Descriptor Block: Detailed Timing (DTD)

Pixel clock: 148.500 MHz
 Refresh Rate: 50.000 Hz (approx.)
 Scan type: Progressive
 Horz Active: 1920
 Vert Active: 1080
 Horz Blank: 720
 Vert Blank: 45
 HSync Delay: 528
 HSync Width: 44
 VSync Delay: 4
 VSync Width: 5
 Image size: 800 mm x 450 mm
 Border: 0 pixels x 0 lines
 Stereo mode: Normal display, no stereo
 Sync: Digital Separate, VSYNC+, HSYNC+

Descriptor Block: Detailed Timing (DTD)

Pixel clock: 127.750 MHz
 Refresh Rate: 49.98 Hz (approx.)
 Scan type: Progressive
 Horz Active: 1920
 Vert Active: 1200
 Horz Blank: 160
 Vert Blank: 29
 HSync Delay: 48
 HSync Width: 32
 VSync Delay: 3
 VSync Width: 6
 Image size: 89 mm x 50 mm
 Border: 0 pixels x 0 lines
 Stereo mode: Normal display, no stereo
 Sync: Digital Separate, VSYNC-, HSYNC+

Descriptor Block: Established Timings III

Version: 10
 Supported Timings
 1280 x 768 @ 60 Hz
 1280 x 960 @ 60 Hz
 1280 x 1024 @ 60 Hz
 1360 x 768 @ 60 Hz
 1440 x 900 @ 60 Hz
 1400 x 1050 @ 60 Hz
 1680 x 1050 @ 60 Hz
 1600 x 1200 @ 60 Hz
 1920 x 1200 @ 60 Hz (RB)

Descriptor Block: Display Product Name

Value: KDS7 Encoder

Block 1

	0	1	2	3	4	5	6	7	8	9	A	B	C	D	E	F
00	02	03	40	F3	4F	9F	10	21	20	14	05	5F	5E	5D	64	63
10	62	04	02	11	23	09	07	01	83	01	00	00	6E	03	0C	00
20	10	00	38	3C	20	00	80	01	02	03	04	67	D8	5D	C4	01
30	3C	80	00	E5	0E	60	61	65	66	E2	00	F9	E3	05	E0	00
40	66	21	56	AA	51	00	1E	30	46	8F	33	00	59	32	00	00
50	00	9E	00	00	00	00	00	00	00	00	00	00	00	00	00	00
60	00	00	00	00	00	00	00	00	00	00	00	00	00	00	00	00
70	00	00	00	00	00	00	00	00	00	00	00	00	00	00	00	1D

Block Type: CTA 861

Checksum verified
 E-EDID CTA Extension Version 3
 Reserved data block offset 64

- Native DTDs in EDID: 3
- Y: Supports underscan
- Y: Supports basic audio
- Y: Supports YCbCr 4:4:4
- Y: Supports YCbCr 4:2:2

CTA Data Block: Tag 2, bytes 15: Video Data

Number of Descriptors: 15

SVD #001: (31) 1920x1080p @ 50 Hz 16:9 Native
 SVD #002: (16) 1920x1080p @ 60 Hz 16:9
 SVD #003: (33) 1920x1080p @ 25 Hz 16:9
 SVD #004: (32) 1920x1080p @ 24 Hz 16:9
 SVD #005: (20) 1920x1080i @ 50 Hz 16:9
 SVD #006: (5) 1920x1080i @ 60 Hz 16:9
 SVD #007: (95) 3840x2160p @ 30 Hz 16:9
 SVD #008: (94) 3840x2160p @ 25 Hz 16:9
 SVD #009: (93) 3840x2160p @ 24 Hz 16:9
 SVD #010: (100) 4096x2160p @ 30 Hz 256:135
 SVD #011: (99) 4096x2160p @ 25 Hz 256:135

SVD #012: (98) 4096x2160p @ 24 Hz 256:135
 SVD #013: (4) 1280x720p @ 60 Hz 16:9
 SVD #014: (2) 720x480p @ 60 Hz 4:3
 SVD #015: (17) 720x576p @ 50 Hz 4:3

CTA Data Block: Tag 1, bytes 3: Audio Data

Number of Descriptors: 1

Audio Format Code: LPCM (IEC 60958 PCM [30, 31])
 Channels: 2
 Sampling Freq: 32 kHz, 44.1 kHz, 48 kHz
 Sampling Size (bit): 16

CTA Data Block: Tag 4, bytes 3: Speaker Allocation

- Front Left/Front Right (FL/FR)

CTA Data Block: Tag 3, bytes 14: Vendor Specific

24-bit IEEE Registration ID: 0x000C03

HDMI 1.4b Vendor Specific Data Block

- CEC Physical Address: 1.0.0.0
- ISRC/ACP: Not supported
- Deep Color
 - 36 bits per color
 - 30 bits per color
 - YCbCr 4:4:4 supported
- DVI dual-link: Not supported
- Max TMDS clock: 300 MHz
- Content types: None
- Latency: Not Present
- Interlaced Latency: Not Present
- Basic 3D: Not supported
- Image Size: No additional information.
- 4K x 2K Support:
 - 3840x2160 30Hz
 - 3840x2160 25Hz
 - 3840x2160 24Hz
 - 4096x2160 24Hz

CTA Data Block: Tag 3, bytes 7: Vendor Specific

24-bit IEEE Registration ID: 0xC45DD8

HDMI Forum Vendor Specific Data Block

- Version: 1
- Max_TMDS_Character_Rate: 300 MHz
- Max_FRL_Rate: Not Supported

Y: SDCD_Present
 N: RR_Capable
 N: CABLE_STATUS
 N: CCBPCI
 N: LTE_340MHz_scramble
 N: Independent_view
 N: Dual_View
 N: 3D_OSD_Disparity
 N: UHD_VIC
 N: DC_48bit_420
 N: DC_36bit_420
 N: DC_30bit_420

CTA Data Block: Extended Tag 14, bytes 5: Y420 Video Data

Number of Descriptors: 4

SVD #016: (96) 3840x2160p @ 50 Hz 16:9
 SVD #017: (97) 3840x2160p @ 60 Hz 16:9
 SVD #018: (101) 4096x2160p @ 50 Hz 256:135
 SVD #019: (102) 4096x2160p @ 60 Hz 256:135

CTA Data Block: Extended Tag 0, bytes 2: Video Capability

CE: Always overscanned
 IT: Always underscanned
 PT: Supports over and underscan
 RGB Quantization: Selectable (via AVI Q)
 YCC Quantization: Selectable (via AVI YQ)

CTA Data Block: Extended Tag 5, bytes 3: Colorimetry

BT.2020-cYCC
 BT.2020-YCC
 BT.2020-RGB

Descriptor Block: Detailed Timing (DTD)

Pixel clock: 85.500 MHz
 Refresh Rate: 59.790 Hz (approx.)
 Scan type: Interlace
 Horz Active: 1366
 Vert Active: 768
 Horz Blank: 426
 Vert Blank: 30
 HSync Delay: 70
 HSync Width: 143
 VSync Delay: 3
 VSync Width: 3
 Image size: 89 mm x 50 mm
 Border: 0 pixels x 0 lines
 Stereo mode: Normal display, no stereo
 Sync: Digital Separate, VSYNC+, HSYNC+

Default Parameters

Page Name	Tab Name	Fields	Editable Field	Exportable Field	Default Values	
Main	AV Routing	Channel ID	Yes	Yes	An unused ethernet channel number is automatically assigned.	
		Channel Name	Yes	Yes	WP-SW2-EN7-xxxxxxxxxxxx "xxxxxxxxxxxx" is the MAC address.	
		Volume	Yes	Yes	80	
		Mute	Yes	Yes	Off	
		Play/Stop	Yes	Yes	Play	
AV Settings	Auto Switch	Switching Mode	Yes	Yes	Last Connected	
		Signal Loss Switching Delay (sec)	Yes	Yes	10	
		Signal Detection Delay (sec)	Yes	Yes	0	
		Cable Plug Delay (sec)	Yes	Yes	0	
		Cable Unplug Delay (sec)	Yes	Yes	0	
		Signal Loss Switching Manual Override Delay (sec)	Yes	Yes	0	
		Video	Input HDCP Appearance Port 1	Yes	Yes	On
	Input HDCP Appearance Port 2		Yes	Yes	On	
	Maximum Bit Rate		Yes	Yes	Best Effort	
	Maximum Video Frame Rate (%)		Yes	Yes	100	
	Audio	Audio Source Mode	Yes	Yes	Last Connected	
		Audio Source Selection	Yes	Yes	HDMI/USB-C	
		Audio Connection Guard Time (sec)	Yes	Yes	10	
	EDID Management	EDID Lock	Yes	Yes	On	
		EDID Mode	No	Yes	Default Mode	
Device Settings	General	Host Name	Yes	Yes	WP-SW2-EN7-xxxxxxxxxxxx ("xxxxxxxxxxxx" is the MAC address)	
		Front Panel Lock	Yes	Yes	Off	
		Import/Export Device Settings	Yes	Yes	All including IP	
	Network	Stream Port	No	Yes	Media	
		Stream 802.1Q	No	Yes	N/A	
		Stream VLAN Tag	No	Yes	N/A	
		Stream DHCP	Yes	Yes	On	
		P3K & Gateway Port	Yes	Yes	Media	
		P3K & Gateway 802.1Q	Yes	Yes	Off	
		P3K & Gateway VLAN Tag	Yes	Yes	N/A	
		P3K & Gateway DHCP	Yes	Yes	N/A	
		IP Casting Mode	Yes	Yes	Multicast	
		TTL	Yes	Yes	64	
		TCP Port	Yes	Yes	5,000	
	UDP Port	Yes	Yes	50,000		
	Time and Date	Date	No	Yes	01-01-1970	
		Time	No	Yes	N/A	
		Time Zone	Yes	Yes	00:00 Greenwich	
		NTP Time Server Usage	Yes	Yes	No	
		NTP Time Server Address	Yes	Yes	N/A	
		NTP Daily Sync Hour	Yes	Yes	N/A	
	Security	HTTPS Server	Yes	Yes	On; Internal Certificate	
		IEE 802.1x Authentication	Yes	Yes	Off	
	Users	Security Status	Yes	Yes	Off	
		Inactivity auto-logout time	Yes	Yes	10	
	Control	Settings	CEC Gateway	Yes	Yes	Enable
			RS-232 Gateway	Yes	Yes	Enable
RS-232 Port			Yes	Yes	5001	
RS-232 Baud rate			Yes	Yes	115200	
RS-232 Data Bits			Yes	Yes	8	
RS-232 Parity			Yes	Yes	None	
RS-232 Stop Bits			Yes	Yes	1	
Diagnostics	Advanced	Active Syslog	Yes	Yes	Off	

Protocol 3000

Kramer devices can be operated using Kramer Protocol 3000 commands sent via serial or Ethernet ports.

Understanding Protocol 3000

Protocol 3000 commands are a sequence of ASCII letters, structured according to the following.

- **Command format:**

Prefix	Command Name	Constant (Space)	Parameter(s)	Suffix
#	Command	_	Parameter	<CR>

- **Feedback format:**

Prefix	Device ID	Constant	Command Name	Parameter(s)	Suffix
~	nn	@	Command	Parameter	<CR><LF>

- **Command parameters** – Multiple parameters must be separated by a comma (.). In addition, multiple parameters can be grouped as a single parameter using brackets ([and]).
- **Parameters attributes** – Parameters may contain multiple attributes. Attributes are indicated with pointy brackets (<...>) and must be separated by a period (.).

The command framing varies according to how you interface with **WP-SW2-EN7**. The following figure displays how the # command is framed using terminal communication software (such as Hercules):

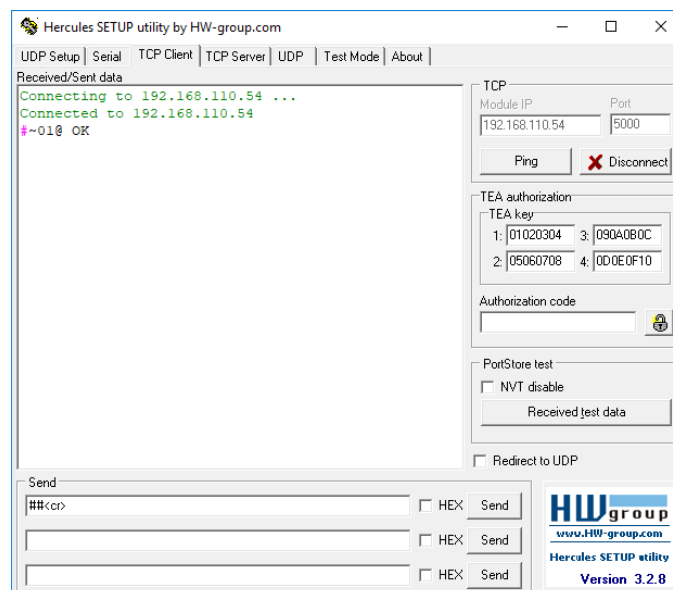

Protocol 3000 Commands

Function	Description	Syntax	Response	Parameters/Attributes	Example
#	Protocol handshaking. NOTE: Validates the Protocol 3000 connection and gets the machine number. Step-in master products use this command to identify the availability of a device.	#<CR>	~nn@_OK<CR><LF>		#<CR>
BEACON-EN	Set beacon rate.	#BEACON-EN port_id,status,rate< CR>	~nn@BEACON-EN port_id,status,rate<CR ><LF>	port_id – ID of the Ethernet port 0 – Media Port 1 – Service Port status – Enable/Disable beacon 0 – Disable (default) 1 – Enable rate – Repetition rate in seconds 1 – 1 second (minimum) 10 – 10 seconds (default) 1800 – 30 minutes (maximum)	Set beacon information: #BEACON-EN_0,1,10<CR>
#BEACON-EN?	Get beacon rate.	#BEACON-EN? <CR>	~nn@BEACON-EN port_id,status,rate<CR ><LF>	port_id – ID of the Ethernet port: 0 – Media Port 1 – Service Port status – Enable/Disable beacon: 0 – Disable (default) 1 – Enable rate – Repetition rate in seconds: 1 – 1 second (minimum) 10 – 10 seconds (default) 1800 – 30 minutes (maximum)	Get beacon information: #BEACON-EN?<CR>
BEACON-INFO?	Get beacon information, including IP address, UDP control port, TCP control port, MAC address, model, name. NOTE: + There is no Set command. Get command initiates a notification. + 'port_id' must be same as '#KDS-GW-ETH' used	#BEACON-INFO? port_id<CR>	~nn@BEACON-INFO port_id,ip_string,udp_p ort,tcp_port,mac_addr ess,model,name<CR> <LF>	port_id – ID of the Ethernet port: 0 – Media Port 1 – Service Port ip_string – Dot-separated representation of the IP address: udp_port – UDP control port tcp_port – TCP control port mac_address – Dash-separated mac address model – Device model name – Device name	Get beacon information: #BEACON-INFO?_0<CR>
BUILD-DATE?	Get device build date	#BUILD-DATE?<C R>	~nn@BUILD-DATE date, time <CR><LF>	date – Format: YYYY/MM/DD time – Format: hh:mm:ss	Get the device build date: #BUILD-DATE?<CR>
CEC-GW-PORT-ACTIVE	Set CEC Gateway mode - Whether CEC commands coming from HDMI stream to LAN	#CEC-GW-PORT-ACTIVE gw_mode<CR>	~nn@CEC-GW-PORT-ACTIVE gw_mode<CR><LF>	gw_mode: 0 – CEC Passthrough mode 1 – CEC Gateway mode – command to be sent to HDMI Input. 2 – CEC Gateway mode – command to be sent to HDMI Output. (KDS-DEC7 & WP-DEC7) 3 – CEC Gateway mode – command to be sent to HDMI Loop Through (KDS-EN7, KDS-SW2-EN7)	Set CEC Gateway mode: #CEC-GW-PORT-ACTIVE 1<CR>
CEC-GW-PORT-ACTIVE?	Get CEC Gateway mode - Whether CEC commands coming from HDMI stream to LAN	#CEC-GW-PORT-ACTIVE? <CR>	~nn@CEC-GW-PORT-ACTIVE gw_mode<CR><LF>	gw_mode: 0 – CEC Passthrough mode 1 – CEC Gateway mode – command to be sent to HDMI Input. 2 – CEC Gateway mode – command to be sent to HDMI Output. (KDS-DEC7 & WP-DEC7) 3 – CEC Gateway mode – command to be sent to HDMI Loop Through (KDS-EN7, KDS-SW2-EN7)	Get CEC Gateway mode: #CEC-GW-PORT-ACTIVE?<CR>
CEC-NTFY	Notify about CEC command retrieved from bus. NOTE: Notification is sent to all com ports upon CEC message retrieval from CEC bus	N/A	~nn@CEC-NTFY port_index,len,<cec_c ommand...><CR><LF >	port_index – CEC port notifying the command len – 1–16 cec_command – CEC format command (in HEX format, no leading zeros, no '0x' prefix)	Notify about CEC command retrieved from bus.: -01@CEC-NTFY 1,2,0F36<CR>
CEC-SND	Send CEC command to port.	#CEC-SND port_index,sn_id,cmd _name,cec_len,cec _command<CR>	~nn@CEC-SND port_index,sn_id,cmd _name,cec_mode<CR> <LF>	port_index – CEC port transmitting the command (1 – number of ports) sn_id – serial number of command for flow control and response commands from device cmd_name – command name cec_len – 1–16 cec_command – CEC format command (in HEX format, no leading zeros, no '0x' prefix) cec_mode – CEC mode 0 – Sent (Only support Sent, other error feedback with common P3K error code)	Send CEC command to port: #CEC-SND 1,1,1,2,E004<CR>
COM-ROUTE-ADD	Add a communication route tunnel connection	#COM-ROUTE-ADD com_id,port_type,p ort_id,eth_rep_en,ti meout<CR>	~nn@COM-ROUTE-ADD com_id,port_type,port _id,eth_rep_en,timeou t<CR><LF>	com_id – Machine dependent (number of ports, only 1 accepted) port_type – TCP: 0 – TCP port_id – port number (5000 to 5999) eth_rep_en – Ethernet Reply 0 – COM port does not send replies to new clients 1 – COM port sends replies to new clients. timeout – Keep alive timeout in seconds (1 to 3600)	Add a communication route tunnel connection: #COM-ROUTE-ADD 1,0,5001,1,1<CR>
COM-ROUTE-REMOVE	Remove a communication route tunnel connection.	#COM-ROUTE-RE MOVE com_id<CR>	~nn@COM-ROUTE-R EMOVE com_id<CR><LF>	com_id – Machine dependent (number of ports, only 1 accepted)	Remove a communication route tunnel connection: #COM-ROUTE-REMOVE 1<CR>

Function	Description	Syntax	Response	Parameters/Attributes	Example
COM-ROUTE?	Get communication route tunnel connection state	#COM-ROUTE? com_id<CR>	~nn@COM-ROUTE com_id,port_type,port_id,eth_rep_en,timeout<CR><LF>	com_id – Machine dependent (number of ports, only 1 accepted), * (get all route tunnels) port_type – TCP/UDP 0 – TCP 1 – UDP port_id – TCP/UDP port number eth_rep_en – Ethernet Reply 0 – COM port does not send replies to new clients 1 – COM port sends replies to new clients. timeout – Keep alive timeout in seconds (1 to 3600)	Get tunneling port routing for all route tunnels: #COM-ROUTE?_*<CR>
EDID-ACTIVE	Activate specific EDID Note: only valid in custom mode. in other modes will return error.	#EDID-ACTIVE Input_id, Index<CR>	~nn@EDID-ACTIVE Input_id,Index<CR><LF>	Input_id – 1 Index - Index in EDID List	Set custom EDID #1 active on input 1; If not in CUSTOM mode, return ERROR #EDID-ACTIVE_1,1<CR>
EDID-ACTIVE?	Get current active EDID Note: only valid in custom mode. in other modes will return error.	#EDID-ACTIVE? Input_id<CR>	~nn@EDID-ACTIVE Input_id,Index<CR><LF>	Input_id – 1 Index - Index in EDID List	Get active custom EDID index on Input 1; If not in CUSTOM mode, return ERROR #EDID-ACTIVE?_1<CR>
EDID-LIST?	Get a list of currently existing EDID's (Get only)	#EDID-LIST?<CR>	~nn@EDID-LIST [port_idx,"name"],...<CR><LF>	port_idx – HDMI port index, only 1 is accepted name – EDID file name	Get EDID list #EDID-LIST?<CR> Return: ~nn@EDID-LIST [0,"DEFAULT"],[2,"SONY"],[5,"PANASONIC"]<CR><LF>
EDID-MODE	Set EDID work mode	#EDID-MODE Input_id,Mode,Index<CR>	~nn@EDID-MODE Input_id,Mode,Index<CR><LF>	Input_id – 1 Mode: PASSTHRU (get from decoder) CUSTOM DEFAULT Index: CUSTOM should have an 'index' taken from 'EDID-LIST?'	Set EDID to custom mode, idx is 1 #EDID-MODE 1,CUSTOM,1<CR>
EDID-MODE?	Get EDID work mode Add New Command for KDS-7	#EDID-MODE? Input_id<CR>	~nn@EDID-MODE Input_id,Mode,Index<CR><LF>	Input_id – 1 Mode: PASSTHRU (get from decoder) CUSTOM DEFAULT Index: CUSTOM should have an 'index' taken from 'EDID-LIST?'	Get EDID Mode #EDID-MODE?_1<CR>
EDID-NET-SRC	Set MAC on net device to be EDID source. It is only valid when EDID-MODE is set as PASSTHRU	#EDID-NET-SRC input_id,src_ip<CR>	~nn@EDID-NET-SRC input_id,src_ip<CR><LF>	input_id – 1 src_ip – DEC IP address	Set MAC on net device for Input 1 #EDID-NET-SRC 1,192.168.1.40<CR>
EDID-NET-SRC?	Get MAC on net device of EDID source	#EDID-NET-SRC? input_id<CR>	~nn@EDID-NET-SRC input_id,src_ip<CR><LF>	input_id – 1 src_ip – DEC IP address	Get MAC on Net device for Input 1 #EDID-NET-SRC?_1<CR>
EDID-RM	Remove custom EDID from EDID list. Note: should return ERR if this EDID is in USE.	#EDID-RM Index<CR>	~nn@EDID-RM Index<CR><LF>	Index: 1...N - EDID index to remove. Taken from 'EDID-LIST?'. index 0 (Default) is not removable.	remove EDID from slot 3 and delete the file #EDID-RM 3<CR>
ETH-PORT	Set Ethernet port protocol. NOTE: If the port number you enter is already in use, an error is returned. The port number must be within the following range: 0-(2^16-1).	#ETH-PORT port_type, port_id <CR>	~nn@ETH-PORT port_type, port_id <CR><LF>	port_type: TCP UDP port_id – port_type TCP in range 5000-5099 and port_type UDP in range 50000-50999	Set the Ethernet port protocol for TCP to port 5000: #ETH-PORT TCP,5000<CR>
ETH-PORT?	Get Ethernet port protocol.	#ETH-PORT? port_type<CR>	~nn@ETH-PORT port_type,port_id<CR><LF>	port_type: TCP UDP port_id – port_type TCP in range 5000-5099 and port_type UDP in range 50000-50999	Get the Ethernet port protocol for TCP: #ETH-PORT?_TCP<CR>
ETH-TUNNEL?	Get an open tunnel's parameters.	#ETH-TUNNEL? tunnel_id<CR>	~nn@ETH-TUNNEL [[tunnel_id,com_id,port_type,port_id,eth_ip,remote_port_id,eth_rep_en,connection_type],...] <CR><LF>	tunnel_id – Tunnel ID number, * (get all open tunnels) com_id – Machine dependent 1 – First COM Port port_type – TCP/UDP 0 – TCP port_id – TCP/UDP port number eth_ip – Client IP address remote_port_id – Remote port number eth_rep_en – Ethernet Reply 0 – COM port does not send replies to new clients 1 – COM port sends replies to new clients connection_type – Connection type 1 – wired connection	Get all open tunnel parameters: #ETH-TUNNEL?_*<CR>
FACTORY	Reset device to factory default configuration NOTE: This command deletes all user data from the device. The deletion can take some time. Your device may require powering off and powering on for the changes to take effect.	#FACTORY<CR>	~nn@FACTORY ok<CR><LF>		Reset the device to factory default configuration: #FACTORY<CR>
GTW-MSG-NUM?	Get Control Gateway Messages Counter from the device boot done. Add Recv_Count and Send_Count NOTE: <date> is legacy parameter, for KDS7 always be ignored	#GTW-MSG-NUM? message_type,date <CR>	~nn@GTW-MSG-NUM message_type,date,recv_counter,send_counter<CR><LF>	message_type - where 1 =CEC 3 = RS232 date – Format: DD-MM-YYYY. recv_counter – counter of receive messages send_counter – counter of send messages	Get Control Gateway Messages Counter from certain period #GTW-MSG-NUM?_1,01-01-1970<CR>
HDCP-MOD	Set HDCP mode. NOTE: Set HDCP working mode on the device input: HDCP supported - HDCP_ON [default]. HDCP not supported - HDCP OFF.	#HDCP-MOD in_index, mode <CR>	~nn@HDCP-MOD in_index,mode<CR><LF>	in_index – Number that indicates the specific input: 1-N (N= the total number of inputs) mode – HDCP mode: 0 – HDCP Off 1 – HDCP On	Set the input HDCP-MODE of IN 1 to Off: #HDCP-MOD_1,0<CR>

Function	Description	Syntax	Response	Parameters/Attributes	Example
HDCP-MOD?	Get HDCP mode.NOTE: Set HDCP working mode on the device input: HDCP supported - HDCP_ON [default]. HDCP not supported - HDCP OFF. HDCP support changes following detected sink - MIRROR OUTPUT.	#HDCP-MOD? in_index<CR>	~nn@HDCP-MOD in_index,mode<CR><LF>	in_index – Number that indicates the specific input: 1-N (N= the total number of inputs) mode – HDCP mode: 0 – HDCP Off 1 – HDCP On 3 – HDCP Mirror Mode - used by KDS-7 decoder to allow an HDCP 2.2 source connected to the encoder to play on an HDCP 1.4 TV/display connected to the decoder.	Get the input HDCP-MODE of IN 1 HDMI: #HDCP-MOD?_1<CR>
HDCP-STAT?	Get HDCP signal status. NOTE: io_mode =1 – get the HDCP signal status of the sink device connected to the specified output. io_mode =0 – get the HDCP signal status of the source device connected to the specified input.	#HDCP-STAT? io_mode,in_index<CR>	~nn@HDCP-STAT io_mode,in_index,status<CR><LF>	io_mode – Input/Output 0 – Input 1 – Output in_index – 1-N (N=total number of inputs or outputs) status – Signal encryption status - valid values On/Off where 0 = HDCP Off, 1 = HDCP On	Get the output HDCP-STATUS of IN 1: #HDCP-STAT?_0,1<CR>
HELP	Get command list or help for specific command.	#HELP<CR>	1. Multi-line: ~nn@Device cmd_name,cmd_name<CR><LF>	cmd_name – Name of a specific command	Get the command list: #HELP<CR>
HW-TEMP?	Get device heat	#HW-TEMP? region_id,mode<CR>	~nn@HW-TEMP region_id,temperature<CR><LF>	region_id – Always 0 mode – Celsius or Fahrenheit 0 – Celsius 1 – Fahrenheit temperature – Temperature of the HW region, rounded down to the closest integer	Get temperature in Celsius of first cpu #HW-TEMP?_0,0<CR>
HW-VERSION?	Get hardware version	#HW-VERSION?<CR>	~nn@HW-VERSION hardware_version<CR><LF>	hardware_version – XX.XX.XXXX where the digit groups are: major.minor.version	Get hardware version #HW-VERSION?<CR>
IDV	Set visual indication from device. NOTE: Using this command, some devices can light a sequence of buttons or LEDs to allow identification of a specific device from similar devices.	#IDV<CR>	~nn@IDV ok<CR><LF>		#IDV<CR>
KDS-ACTION	Set action to perform by encoder/decoder.	#KDS-ACTION kds_mode<CR>	~nn@KDS-ACTION kds_mode<CR><LF>	kds_mode – Action (state) for encoder/decoder 0 – Stop 1 – Play 2 – Save config	Stop the encoder/decoder: #KDS-ACTION_0<CR>
KDS-ACTION?	Get last action (state) performed by encoder/decoder.	#KDS-ACTION?<CR>	~nn@KDS-ACTION kds_mode<CR><LF>	kds_mode – Action (state) for encoder/decoder 0 – Stop 1 – Play 2 – Save config	Get the last action performed by the encoder/decoder: #KDS-ACTION?<CR>
KDS-AUD	Set audio source/destination. + Only available on Encoder	#KDS-AUD mode<CR>	~nn@KDS-AUD mode<CR><LF>	mode – Encoder/decoder audio mode Streamer Audio Encoder 0 – Digital (HDMI or USB-C) input 1 – Analog input 2 – None Streamer Audio Decoder 0 – HDMI output 1 – Analog output 2 – Both 3 – None	Set audio source/destination: #KDS-AUD_1<CR>
KDS-AUD?	Get audio source/destination. + Only available on Encoder	#KDS-AUD?<CR>	~nn@KDS-AUD mode<CR><LF>	mode – Encoder/decoder audio mode Streamer Audio Encoder 0 – Digital (HDMI or USB-C) input 1 – Analog input 2 – None Streamer Audio Decoder 0 – HDMI output 1 – Analog output 2 – Both 3 – None	Get audio source/destination: #KDS-AUD?<CR>
KDS-GW-ETH	Set gateway network port	#KDS-GW-ETH gw_type,netw_id<CR>	~nn@KDS-GW-ETH gw_type,netw_id<CR><LF>	gw_type: 0 – Control netw_id – Network ID–the device network interface (if there is more than one): 0 – Media Port 1 – Service Port	Set Dante port to eth1 #KDS-GW-ETH_1,1<CR>
KDS-GW-ETH?	Get gateway network port.	#KDS-GW-ETH? gw_type<CR>	~nn@KDS-GW-ETH gw_type,netw_id<CR><LF>	gw_type: 0 – Control netw_id – Network ID–the device network interface (if there is more than one). 0 – Media Port 1 – Service Port	Get Dante port #KDS-GW-ETH?_1<CR>
KDS-METHOD	Set unicast / multicast . Add Set Command ; Add Multicast	#KDS-METHOD 1<CR>	~nn@KDS-METHOD method<CR><LF>	method – Streaming method 1 - Unicast 2 - Multicast	Set current streaming method of encoder/decoder: #KDS-METHOD_1<CR>
KDS-METHOD?	Get unicast / multicast Add Multicast.	#KDS-METHOD?<CR>	~nn@KDS-METHOD method<CR><LF>	method – Streaming method 1 – Unicast 2 – Multicast	Get current streaming method of encoder/decoder: #KDS-METHOD<CR>
KDS-MULTICAST	Set multicast group address and TTL value.	#KDS-MULTICAST group_ip,ttl<CR>	~nn@KDS-MULTICAST group_ip,ttl<CR><LF>	group-ip – Ignored ttl - Time to Live of the streamed packets.	Set multicast group address and TTL value #KDS-MULTICAST 0.0.0.64<CR>
KDS-MULTICAST?	Get multicast group address and TTL value.	#KDS-MULTICAST?<CR>	~nn@KDS-MULTICAST group_ip,ttl<CR><LF>	group-ip –Ignored ttl - Time to Live of the streamed packets.	Get multicast group address and TTL value #KDS-MULTICAST?<CR>
KDS-RATIO?	Get aspect ratio.	#KDS-RATIO?<CR>	~nn@KDS-RATIO value<CR><LF>	value – Streamer Decoder Aspect Ratio width:height, for example "16:9"	Get Aspect Ratio #KDS-RATIO?<CR>

KDS-RESOL?	Get actual AV stream resolution.	#KDS-RESOL? io_mode,io_index,is_native<CR>	~nn@KDS-RESOL? io_mode,io_index,is_native,resolution<CR><LF>	io_mode – Input/Output 0 – Input 1 – Output io_index – Number that indicates the specific input or output port: 1-N (N= the total number of input or output ports) is_native – Native resolution flag 0 – Off 1 – On resolution – Resolution index: 0=No Signal 1=640x480p@59.94Hz/60Hz 2=720x480p@59.94Hz/60Hz 3=(Reserved) 4=1280x720p@59.94Hz/60Hz 5=1920x1080i@59.94Hz/60Hz 6=720(1440)x480i@59.94Hz/60Hz 7-15=(Reserved) 16=1920x1080p@59.94Hz/60Hz 17=720x576p@50Hz 18=(Reserved) 19=1280x720p@50Hz 20=1920x1080i@50Hz 21-30=(Reserved) 31=1920x1080p@50Hz 32=1920x1080p@23.97Hz/24Hz 33=1920x1080p@25Hz 34=1920x1080p@29.97Hz/30Hz 35-38=(Reserved) 39=1920x1080i@50Hz 40-64=(Reserved) 65=800x600p@60Hz 66=1024x768@60Hz 67=1280x768p@60Hz 68=1280x1024p@60Hz 69=1600x1200p@60Hz 70=1680x1050p@60Hz 71=1920x1200@60Hz 72=3840x2160p@24Hz 73=3840x2160p@25Hz 74=3840x2160p@30Hz 75=3840x2160p@50Hz 76=3840x2160p@60Hz 77-97=(Reserved) 98=4096x2160p@24Hz 99=4096x2160p@25Hz 100=4096x2160p@30Hz 101=4096x2160p@50Hz 102=4096x2160p@60Hz 103-1000=(Reserved) 1000=640x350@85Hz 1001=640x400p@85Hz 1002=720x400p@85Hz 1003=(Reserved) 1004=640x480p@72Hz 1005=640x480p@75Hz 1006=640x480p@85Hz 1007=(Reserved) 1008=(Reserved) 1009=800x600p@72Hz 1010=800x600p@75Hz 1011=800x600p@85Hz 1012=848x480p@60Hz 1013=1024x768i@43Hz 1014=(Reserved) 1015=1024x768p@70Hz 1016=1024x768p@75Hz 1017=1024x768p@85Hz 1018=1152x864p@75Hz 1019=(Reserved) 1020=(Reserved) 1021=1280x768p@85Hz 1022=1280x800p@60Hz 1023=1280x800p@75Hz 1024=1280x800p@85Hz 1025=1280x800p@120Hz 1026=1280x960p@60Hz 1027=1280x960p@85Hz 1028=(Reserved) 1029=1280x1024p@75Hz 1030=1280x1024p@85Hz 1031=1360x768p@60Hz 1032=1366x768p@60Hz 1033=1400x1050p@60Hz 1034=1400x1050p@75Hz 1035=1400x1050p@85Hz 1036=1440x900p@60Hz 1037=1440x900p@75Hz 1038=1440x900p@85Hz 1039=1600x900p@60Hz 1040=(Reserved) 1041=1600x1200p@65Hz 1042=(Reserved) 1043=1600x1200p@75Hz 1044=1600x1200p@85Hz 1045=(Reserved) 1046=1680x1050p@75Hz 1047=1680x1050p@85Hz 1048=1792x1344p@60Hz 1049=1792x1344p@75Hz 1050=1856x1392p@60Hz 1051=1856x1392p@75Hz 1052=1920x1200p@50Hz 1053=(Reserved) 1054=1920x1200p@75Hz
------------	----------------------------------	---	---	--

Function	Description	Syntax	Response	Parameters/Attributes	Example										
				1055=1920x1200p@85Hz 1056=1920x1440p@60Hz 1057=1920x1440p@75Hz 1058=(Reserved) 1059=2048x1152p@60Hz 1060=2560x1600p@60Hz 1061=2560x1600p@75Hz 1062=2560x1600p@80Hz											
LDFW	Load new firmware file. NOTE: In most devices, firmware data is saved to flash memory, but the memory does not update until receiving the "UPGRADE" command and is restarted.	Step 1: #LDFW size<CR> Step 2: If ready was received, send FIRMWARE_DATA	Response 1: ~nn@LDFW_size ready<CR><LF> Response 2: ~nn@LDFW_size_ok <CR><LF>	size – Size of firmware data that is sent firmware_data – HEX or KFW file in protocol packets Using the Packet Protocol Send a command: LDRV, LOAD, LDEDID Receive Ready or ERR### If Ready: a. Send a packet, b. Receive OK on the last packet, c. Receive OK for the command Packet structure: Packet ID (1, 2, 3...) (2 bytes in length) Length (data length + 2 for CRC) – (2 bytes in length) Data (data length -2 bytes) CRC – 2 bytes <table border="1"> <tr> <td>01</td> <td>02</td> <td>03</td> <td>04</td> <td>05</td> </tr> <tr> <td>Packet ID</td> <td>Length</td> <td>Data</td> <td colspan="2">CRC</td> </tr> </table> Response: ~nnn_ok<CR><LF> (Where NNNN is the received packet ID in ASCII hex digits.)	01	02	03	04	05	Packet ID	Length	Data	CRC		
01	02	03	04	05											
Packet ID	Length	Data	CRC												
LOCK-EDID	Lock last read EDID.	#LOCK-EDID in_index,lock_mode <CR>	~nn@LOCK-EDID in_index,lock_mode<CR> R><LF>	in_index – 1 lock_mode – On/Off 0 – Off unlocks EDID 1 – On locks EDID	Lock the last read EDID from the HDMI In 1 input #LOCK-EDID_1,1<CR>										
LOCK-EDID?	Get EDID lock state.	#LOCK-EDID? in_index<CR>	~nn@LOCK-EDID in_index,lock_mode<CR> R><LF>	in_index – 1 lock_mode – On/Off 0 – Off unlocks EDID 1 – On locks EDID	Get EDID lock state for Input 1 #LOCK-EDID?_1,1<CR>										
LOCK-FP	Lock the front panel.	#LOCK-FP lock/unlock<CR>	~nn@LOCK-FP lock/unlock<CR><LF>	Lock/Unlock – On/Off 0 – (Off) Unlocks EDID 1 – (On) Locks EDID	Unlock front panel: #LOCK-FP_0<CR>										
LOCK-FP?	Get the front panel lock state.	#LOCK-FP?<CR>	~nn@LOCK-FP lock/unlock<CR><LF>	Lock/Unlock – On/Off Off – Unlocks EDID On – Locks EDID	Get the front panel lock state: #LOCK-FP?<CR>										
LOG-ACTION	Reset events log.	#LOG-ACTION action,period<CR>	~nn@LOG-ACTION action,period<CR><LF> >	action - 1 - Start, start logging 2 - Pause, pause logging but keep log content 3 - Resume, resume the logging 4 - Reset, clear all current logs, keep logging period - Ignored	Reset events log : #LOG-ACTION_4,1<CR>										
LOG-ACTION?	Get log state.	#LOG-ACTION? <CR>	~nn@LOG-ACTION action,period<CR><LF> >	action - One of 1 - Start, start logging 2 - Pause, pause logging but keep log content 3 - Resume, resume the logging 4 - Reset, clear all current logs, keep logging period - Ignored	Get log state: #LOG-ACTION?<CR>										
LOG-TAIL?	Get the last "n" lines of message logs. NOTE: Used for advanced troubleshooting. Helps find error root causes and gets details not displayed in the error code number.	#LOG-TAIL? line_num<CR>	Get: ~nn@LOG-TAILnn<CR> R><LF> Line content #1<CR><LF> Line content #2<CR><LF>Etc...	line_num – Optional, default line_num is 10	Get the last "2" lines of message logs: #LOG-TAIL?_2<CR>										
LOGIN	Set protocol permission. NOTE: The permission system works only if security is enabled with the "SECUR" command. LOGIN allows the user to run commands with an End User or Administrator permission level. When the permission system is enabled, LOGIN enables running commands with the User or Administrator permission level. When set, login must be performed upon each connection. It is not mandatory to enable the permission system in order to use the device. In each device, some connections allow logging in to different levels. Some do not work with security at all. Connection may logout after timeout.	#LOGIN login_level,password d<CR>	~nn@LOGIN login_level,password ok<CR><LF>	login_level – Level of permissions required (only 'admin' is acceptable) password – Predefined password (by PASS command). Default password is 'admin'.	Set the protocol permission level to Admin (when the password defined in the PASS command is 33333): #LOGIN admin,33333<CR>										
LOGIN?	Get current protocol permission level.NOTE: The permission system works only if security is enabled with the "SECUR" command. For devices that support security, LOGIN allows the user to run commands with an End User or Administrator permission level. In each device, some connections allow logging in to different levels. Some do not work with security at all. Connection may logout after timeout.	#LOGIN?<CR>	~nn@LOGIN login_level<CR><LF>	login_level – Level of permissions required (only 'admin' is acceptable).	Get current protocol permission level: #LOGIN?<CR>										

Function	Description	Syntax	Response	Parameters/Attributes	Example
LOGOUT	Cancel current permission level.NOTE: Logs out from End User or Administrator permission levels to Not Secure.	#LOGOUT<CR>	~nn@LOGOUTok<CR><LF>		#LOGOUT<CR>
LOGOUT-TIMEOUT	Set inactivity auto-logout time.	# LOGOUT-TIMEOUT time<CR>	~nn@ LOGOUT-TIMEOUT time<CR><LF>	time – minutes of inactivity that causes automatic logout.	Set Inactivity auto-logout time to 10 #LOGOUT-TIMEOUT 10<CR>
LOGOUT-TIMEOUT?	Get inactivity auto-logout time.	#LOGOUT-TIMEOUT?<CR>	~nn@LOGOUT-TIMEOUT time<CR><LF>	time – minutes of inactivity that causes automatic logout.	Get Inactivity auto-logout time #LOGOUT-TIMEOUT?<CR>
MODEL?	Get device model. NOTE: This command identifies equipment connected to WP-SW2-EN7 and notifies of identity changes to the connected equipment. The Matrix saves this data in memory to answer REMOTE-INFO requests.	#MODEL?<CR>	~nn@MODEL model_name <CR><LF>	model_name – String of up to 24 printable ASCII chars.	Get the device model: #MODEL?<CR>
NAME	Set machine name. NOTE: The machine name is not the same as the model name. The machine name is used to identify a specific machine or a network in use (with DNS feature on).	#NAME interface_id,host_name<CR>	~nn@NAME interface_id,host_name<CR><LF>	interface_id – always 0 host_name – String of up to 24 alpha-numeric chars (can include hyphen, underscore, not at the beginning or end).	Set the machine DNS name of the device to room-442: #NAME_0,room-442<CR>
NAME?	Get machine or DANTE (DNS) name. NOTE: The machine name is not the same as the model name. The machine name is used to identify a specific machine or a network in use (with DNS feature on).	#NAME? interface_id<CR>	~nn@NAME interface_id,host_name<CR><LF>	interface_id – always 0 host_name – String of up to 24 alpha-numeric chars (can include hyphen, underscore, not at the beginning or end).	Get the DNS name of the device: #NAME?_0<CR>
NAME-RST	Reset machine (DNS) name to factory default.NOTE: Factory default of machine (DNS) name is "KRAMER_" + 4 last digits of device serial number.	#NAME-RST<CR>	~nn@NAME-RST OK<CR><LF>		Reset the machine name (S/N last digits are 0102): #NAME-RST<CR>
NET-CONFIG	Set a network configuration. NOTE: For Backward compatibility, the id parameter can be omitted. In this case, the Network ID, by default, is 0, which is the Ethernet control port. NOTE: If the gateway address is not compliant to the subnet mask used for the host IP, the command will return an error. Subnet and gateway compliancy specified by RFC950. NOTE: This set the device to DHCP OFF automatically.	#NET-CONFIG netw_id,net_ip,net_mask,gateway<CR>	~nn@NET-CONFIG netw_id,net_ip,net_mask,gateway<CR><LF>	netw_id – Network ID–ID of the Ethernet port: 0 – Media Port 1 – Service Port net_ip – Network IP net_mask – Network mask gateway – Network gateway	Set the device network parameters to IP address 192.168.113.10, net mask 255.255.0.0, and gateway 192.168.0.1: #NET-CONFIG 0,192.168.113.10,255.255.0.0,192.168.0.1<CR>
NET-CONFIG?	Get a network configuration.	#NET-CONFIG? netw_id<CR>	~nn@NET-CONFIG netw_id,net_ip,net_mask,gateway<CR><LF>	netw_id – Network ID–ID of the Ethernet port: 0 – Media Port 1 – Service Port net_ip – Network IP net_mask – Network mask gateway – Network gateway	Get network configuration: #NET-CONFIG?_0<CR>
NET-DHCP	Set DHCP mode.NOTE: Only 1 is relevant for the mode value. To disable DHCP, the user must configure a static IP address for the device. Connecting Ethernet to devices with DHCP may take more time in some networks. To connect with a randomly assigned IP by DHCP, specify the device DNS name (if available) using the NAME command. You can also get an assigned IP by direct connection to USB or RS-232 protocol port, if available. For proper settings consult your network administrator. NOTE: For Backward compatibility, the id parameter can be omitted. In this case, the Network ID, by default, is 0, which is the Ethernet control port.	#NET-DHCP netw_id,dhcp_state<CR>	~nn@NET-DHCP netw_id,dhcp_state<CR><LF>	netw_id – Network ID–the device network interface (if there are more than one). Counting is 0 based, meaning the control port is '0', additional ports are 1,2,3.... dhcp_state – 1 – Try to use DHCP. (If unavailable, use the IP address set by the factory or the net-ip command).	Enable DHCP mode for port 1, if available: #NET-DHCP_1,1<CR>
NET-DHCP?	Get DHCP mode NOTE: For Backward compatibility, the id parameter can be omitted. In this case, the Network ID, by default, is 0, which is the Ethernet control port.	#NET-DHCP? netw_id<CR>	~nn@NET-DHCP netw_id,dhcp_state<CR><LF>	netw_id – Network ID–the device network interface (if there are more than one). Counting is 0 based, meaning the control port is '0', additional ports are 1,2,3.... dhcp_state – 1 – Try to use DHCP. (If unavailable, use the IP address set by the factory or the net-ip command).	Get DHCP mode for port 1, if available: #NET-DHCP?_1<CR>
NET-MAC?	Get MAC address.	#NET-MAC?<CR>	~nn@NET-MAC mac_address<CR><LF>	mac_address – Unique MAC address. Format: XX-XX-XX-XX-XX-XX where X is hex digit	#NET-MAC?<CR>
NET-STAT?	Get net connection list of this machine. NOTE: The response is returned in one line and terminated with<CR><LF>. The response format lists signal IDs separated by commas. This is an Extended Protocol 3000 command.	#NET-STAT?<CR>	~nn@NET-STAT [(<port_type>:<port_index>,<client_ip>:<client_port>),state],...<CR><LF>	port_type – TCP/UDP 0 – TCP 1 – UDP port_index - Device port client_ip – Dot-separated representation of the IP address client_port - Client port state – listen or established	Get net connection list of this machine: #NET-STATE?<CR> -01@NETSTAT [(TCP:80,0.0.0.0:0),LISTEN],[TCP:5000,0.0.0.0:0),LISTEN], [(TCP:80,192.168.114.3:52400),ESTABLISHED],[TCP:5000,192.168.1.100:51647),ESTABLISHED]<CR><LF>

Function	Description	Syntax	Response	Parameters/Attributes	Example
NET-IP?	Get a network IP address. This is an UDP protocol only.	#NET-IP?<CR>	~nn@NET-IP net_ip<CR><LF>	net_ip – Network IP	Get network ip address: #NET-IP?<CR>
PASS	Set password for login level. The default password is "admin".	#PASS login_level,password d<CR>	~nn@PASS login_level,Password< CR><LF>	login_level – Level of login to set (admin support only). password – Password for the login_level. 8 to 24 characters (letters, numbers, and symbols without spaces or commas), at least including one number, one symbols without spaces or commas, one uppercase letter and one lowercase letter.	Set the password for the admin protocol permission level to 33333: #PASS_admin,33333<CR>
PASS?	Get password for login level. The default password is "admin".	#PASS? login_level<CR>	~nn@PASS login_level,password< CR><LF>	login_level – Level of login to set (End User or Administrator). password – Password for the login_level.	Get the password for the admin protocol permission level: #PASS?_admin<CR>
PORT-DIRECTION	Set port direction as input or output.	#PORT-DIRECTION <direction_type>.<port_format>.<port_index>.<signal_type>,<direction><CR>	~nn@PORT-DIRECTION <direction_type>.<port_format>.<port_index>.<signal_type>,<direction><CR><LF>	The following attributes comprise the signal ID: <direction_type> – Direction of the port: IN – Input OUT – Output BOTH – Bi-directional <port_format> – Type of signal on the port: ANALOG_AUDIO <port_index> – The port number as printed on the front or rear panel <signal_type> – Signal ID attribute: AUDIO <direction> – Direction of the port: IN – Input OUT – Output	Set audio analog port direction as input #PORT-DIRECTION both.analog.1.audio,IN<CR>
PORT-DIRECTION?	Get port direction.	#PORT-DIRECTION? <direction_type>.<port_format>.<port_index>.<signal_type>><CR>	~nn@PORT-DIRECTION <direction_type>.<port_format>.<port_index>.<signal_type>,<direction><CR><LF>	The following attributes comprise the signal ID: <direction_type> – Direction of the port: IN – Input OUT – Output BOTH – Bi-directional <port_format> – Type of signal on the port: ANALOG_AUDIO IR <port_index> – The port number as printed on the front or rear panel <signal_type> – Signal ID attribute: AUDIO IR <direction> – Direction of the port: IN – Input OUT – Output	Get audio analog port direction #PORT-DIRECTION? both.analog.1.audio<CR>
PORTS-LIST?	Get the port list of this machine. NOTE: The response is returned in one line and terminated with<CR><LF>. The response format lists port IDs separated by commas. This is an Extended Protocol 3000 command.	#PORTS-LIST?<CR>	~nn@PORTS-LIST [<direction_type>.<port_format>.<port_index>,<...>]<CR><LF>	The following attributes comprise the port ID: <direction_type> – Direction of the port: IN OUT BOTH <port_format> – Type of signal on the port: HDMI ANALOG_AUDIO STREAM RS-232 USB_C <port_index> – The port number as printed on the front or rear panel	Get the ports list: #PORTS-LIST?<CR>
RESET	Reset device NOTE: To avoid locking the port due to a USB bug in Windows, disconnect USB connections immediately after running this command. If the port was locked, disconnect and reconnect the cable to reopen the port.	#RESET<CR>	~nn@RESET ok<CR><LF>		Reset the device: #RESET<CR>
ROLLBACK	Rollback firmware to standby version.	#ROLLBACK<CR>	~nn@ROLLBACK ok<CR><LF>		Perform firmware rollback: #ROLLBACK<CR>
SECUR	Start/stop security. NOTE: The permission system works only if security is enabled with the "SECUR" command.	#SECUR security_state<CR>	~nn@SECUR security_state<CR><LF>	security_state – Security state 0 – OFF (disables security) 1 – ON (enables security)	Enable the permission system: #SECUR_0<CR>
SECUR?	Get security state.	#SECUR?<CR>	~nn@SECUR security_state<CR><LF>	security_state – Security state 0 – OFF (disables security) 1 – ON (enables security)	Get security state: #SECUR?<CR>
SIGNALS-LIST?	Get signal ID list of this machine. NOTE: The response is returned in one line and terminated with<CR><LF>. The response format lists signal IDs separated by commas. This is an Extended Protocol 3000 command.	#SIGNALS-LIST?<CR><LF>	~nn@SIGNALS-LIST [<direction_type>.<port_format>.<port_index>.<signal_type>.<index>,<...>]<CR><LF>	The following attributes comprise the signal ID: <direction_type> – Direction of the port: IN – Input OUT – Output BOTH – Bi-directional (e.g. for RS-232) <port_format> – Type of signal on the port: HDMI ANALOG_AUDIO STREAM RS-232 USB_C <port_index> – The port number as printed on the front or rear panel <signal_type> – Signal ID attribute: VIDEO AUDIO RS232 USB <index> – Indicates a specific channel number when there are multiple channels of the same type	Get signal ID list: #SIGNALS-LIST?<CR>

Function	Description	Syntax	Response	Parameters/Attributes	Example
SN?	Get device serial number.	#SN? <CR>	~nn@SN_serial_num <CR><LF>	serial_num – 14 decimal digits, factory assigned	Get the device serial number: #SN?<CR>
STANDBY-VERSION?	Get standby firmware version.	#STANDBY-VERSION?<CR>	~nn@STANDBY-VERSION? standby_version<CR> <LF>	standby_version – XX.XX.XXXX where the digit groups are: major.minor.build version	Get standby version #STANDBY-VERSION?<CR>
TIME	Set device time and date. NOTE: The year must be 4 digits. The device does not validate the day of week from the date. Time format - 24 hours. Date format - Day, Month, Year.	#TIME day_of_week,date,d ata<CR>	~nn@TIME day_of_week,date,d ata<CR><LF>	day_of_week – One of {SUN,MON,TUE,WED,THU,FRI,SAT} date – Format: DD-MM-YYYY where YYYY = Year MM = Month DD = Day data – Format: hh:mm:ss where hh = hours mm = minutes ss = seconds	Set device time and date to December 5, 2018 at 2:30pm: #TIME_mon_05-12-2018,14:30:00<CR>
TIME?	Get device time and date. NOTE: The year must be 4 digits. The device does not validate the day of week from the date. Time format - 24 hours. Date format - Day, Month, Year.	#TIME?<CR>	~nn@TIME day_of_week,date,d ata<CR><LF>	day_of_week – One of {SUN,MON,TUE,WED,THU,FRI,SAT} date – Format: YYYY/MM/DD where YYYY = Year MM = Month DD = Day data – Format: hh:mm:ss where hh = hours mm = minutes ss = seconds	Get device time and date: #TIME?<CR>
TIME-LOC	Set local time offset from UTC/GMT. NOTE: If the time server is configured, device time calculates by adding UTC_off to UTC time (that it got from the time server) + 1 hour if daylight savings time is in effect. TIME command sets the device time without considering these settings. NOTE: Daylight saving time not supported. NOTE: Restart unit to take effect.	#TIME-LOC utc_off,dst_state<C R>	~nn@TIME-LOC utc_off,dst_state<CR> <LF>	utc_off – Offset of device time from UTC/GMT (without daylight time correction), format HH:MM (:MM is optional) HH – Hours, -12 to 13 MM – Minutes, 00 to 59 dst_state – Daylight saving time state, 0 = no daylight saving time.	Set local time offset to 3 with no daylight-saving time: #TIME-LOC_3,0<CR> Or #TIME-LOC_03:00,0<CR>
TIME-LOC?	Get local time offset from UTC/GMT. NOTE: If the time server is configured, device time is calculated by adding UTC_off to UTC time (taken from the time server) + 1 hour if daylight savings time is in effect. TIME command sets the device time without considering these settings. NOTE: Daylight saving time not supported.	#TIME-LOC?<CR>	~nn@TIME-LOC utc_off,dst_state<CR> <LF>	utc_off – Offset of device time from UTC/GMT (without daylight time correction), format HH:MM HH – Hours, -12 ~ 13 MM – Minutes, 00 ~ 59 dst_state – Daylight saving time state, 0 = no daylight saving time	Get local time offset from UTC/GMT: #TIME-LOC?<CR>
TIME-SRV	Set time server. NOTE: This command is needed for setting UDP timeout for the current client list.	#TIME-SRV mode,time_server_i p,sync_hour<CR>	~nn@TIME-SRV mode,time_server_ip,s ync_hour,server_statu s<CR><LF>	mode – On/Off where 0 = Off, 1 = On time_server_ip – Time server IP address sync_hour – Hour in day for time server sync server_status – On/Off	Set time server with IP address of 128.138.140.44 to ON: #TIME-SRV 1,128.138.140.44,0,1<CR>
TIME-SRV?	Get time server. NOTE: This command is needed for setting UDP timeout for the current client list.	#TIME-SRV?<CR>	~nn@TIME-SRV mode,time_server_ip,s ync_hour,server_statu s<CR><LF>	mode – On/Off where 0 = Off, 1 = On time_server_ip – Time server IP address sync_hour – Hour in day for time server sync server_status – On/Off	Get time server: #TIME-SRV?<CR>
UART	Set com port configuration. NOTE: In the FC-2x the serial port is selectable to RS-232 or RS-485 (usually serial port 1). If Serial is configured when RS-485 is selected, the RS-485 UART port automatically changes. The command is backward compatible, meaning that if the extra parameters do not exist, FW goes to RS-232. Stop_bits 1.5 is only relevant for 5 data_bits.	#UART com_id,baud_rate,d ata_bits,parity,stop_ bits_mode,serial_ty pe,485_term<CR>	~nn@UART com_id,baud_rate,d ata_bits,parity,stop_ bits_mode,serial_type,485_ term<CR><LF>	com_id – 1 to n (machine dependent) baud_rate – 9600 - 115200 data_bits – 5-8 parity – Parity Type 0 – No 1 – Odd 2 – Even stop_bits_mode – 1/1.5/2 serial_type – 232/485 0 – 232 1 – 485 485_term – 485 termination state 0 – disable 1 – enable (optional - only used when serial_type is 485)	Set baud rate to 9600, 8 data bits, parity to none and stop bit to 1: #UART 9600,8,node,1<CR>
UART?	Get com port configuration. NOTE: In the FC-2x the serial port is selectable to RS-232 or RS-485 (usually serial port 1). If Serial is configured when RS-485 is selected, the RS-485 UART port automatically changes. The command is backward compatible, meaning that if the extra parameters do not exist, FW goes to RS-232. Stop_bits 1.5 is only relevant for 5 data_bits.	#UART? com_id<CR>	~nn@UART_com_id, baud_rate,data_bits,p arity,stop_bits_mode, serial_type, 485_term <CR><LF>	com_id – 1 to n (machine dependent) baud_rate – 9600 - 115200 data_bits – 5-8 parity – Parity Type 0 – No 1 – Odd 2 – Even 3 – Mark 4 – Space stop_bits_mode – 1/1.5/2 serial_type – 232/485 0 – 232 1 – 485 485_term – 485 termination state 0 – disable 1 – enable (optional - only used when serial_type is 485)	Set baud rate to 9600, 8 data bits, parity to none and stop bit to 1: #UART 1,9600,8,node,1<CR>
UPG-TIME?	Get firmware version last upgrade date/time Add New Command for KDS-7	#UPG-TIME? <CR>	~nn@UPG-TIME date,data<CR><LF>	date – Format: DD-MM-YYYY. data – Format: hh:mm:ss where	Get last upgrade date/time #UPG-TIME?<CR>

Function	Description	Syntax	Response	Parameters/Attributes	Example
UPGRADE	Perform firmware upgrade. NOTE: Not necessary for some devices. Firmware usually uploads to a device via a command like LDFW. Reset the device to complete the process.	#UPGRADE<CR>	~nn@UPGRADE ok<CR><LF>		Perform firmware upgrade: #UPGRADE<CR>
VERSION?	Get firmware version number.	#VERSION?<CR>	~nn@VERSION firmware_version<CR><LF>	firmware_version – XX.XX.XXXX where the digit groups are: major.minor.build version	Get the device firmware version number: #VERSION?<CR>
X-AUD-DESC?	Get audio signal info NOTE: + This is an Extended Protocol 3000 command. + On KDS7 on support activated port	#X-AUD-DESC? <direction_type>.<port_index>.<port_format>.<port_index> <CR>	~nn@X-AUD-DESC? <direction_type>.<port_index>.<port_format>.<port_label>.<signal_type>.<index>.<ch_tot,samp_rate,aud_format><CR><LF>	The following attributes comprise the signal ID: <direction_type> – Direction of the port: IN – Input OUT – Output BOTH – Bi-directional (e.g. for RS-232) <port_format> – Type of signal on the port: HDMI ANALOG_AUDIO STREAM <port_index> – The port number as printed on the front or rear panel <signal_type> – Signal ID attribute: AUDIO <index> – Indicates a specific channel number when there are multiple ch_tot – Total number of channels samp_rate – Sample rate aud_format – Audio Format: LPCM – Linear Pulse Code Modulation audio Non-LPCM – None Linear Pulse Code Modulation audio, like Dolby Digital, DTS, etc. HBR – High Bitrate Audio, like Dolby TrueHD, DTS HD Master Audio	Get the audio signal info: #X-AUD-DESC? out.hdmi.1<CR>
X-AUD-LVL	Set audio level of a specific signal. NOTE: This is an Extended Protocol 3000 command.	#X-AUD-LVL <direction_type>.<port_index>.<signal_type>.<index>.<audio_level> <CR>	~nn@X-AUD-LVL <direction_type>.<port_index>.<signal_type>.<index>.<audio_level><CR><LF>	The following attributes comprise the signal ID: <direction_type> – Direction of the port: OUT – Output <port_format> – Type of signal on the port: ANALOG_AUDIO <port_index> – The port number as printed on the front or rear panel <signal_type> – Signal ID attribute: AUDIO <index> – Indicates a specific channel number when there are multiple channels of the same type. audio_level – Audio level in dB (range between -60 to +30) depending of the ability of the product.	Set the audio level of a specific signal to 10: #X-AUD-LVL in.analog_audio.1.audio.1,10<CR>
X-AUD-LVL?	Get audio level of a specific signal. NOTE: This is an Extended Protocol 3000 command.	#X-AUD-LVL? <direction_type>.<port_index>.<signal_type>.<index><CR>	~nn@X-AUD-LVL <direction_type>.<port_index>.<signal_type>.<index>.<audio_level><CR><LF>	The following attributes comprise the signal ID: <direction_type> – Direction of the port: OUT – Output <port_format> – Type of signal on the port: ANALOG_AUDIO <port_index> – The port number as printed on the front or rear panel <signal_type> – Signal ID attribute: AUDIO <index> – Indicates a specific channel number when there are multiple channels of the same type. audio_level – Audio level in dB (range between -60 to +30) depending of the ability of the product.	Get the audio level of a specific signal: #X-AUD-LVL? out.analog_audio.1.audio.1<CR>
X-AV-SW-MODE	Set auto-switch mode per output. NOTE: This is an Extended Protocol 3000 command.	#X-AV-SW-MODE <direction_type>.<port_index>.<signal_type>.<index>.<connection_mode><CR>	~nn@X-AV-SW-MODE E <direction_type>.<port_index>.<signal_type>.<index>.<connection_mode><CR><LF>	The following attributes comprise the signal ID: <direction_type> – Direction of the port: IN – Input OUT – Output BOTH – Bi-directional (e.g. for RS-232) <port_format> – Type of signal on the port: HDMI ANALOG_AUDIO STREAM <port_index> – The port number as printed on the front or rear panel. <signal_type> – Signal ID attribute: VIDEO AUDIO <index> – Indicates a specific channel number when there are multiple channels of the same type. connection_mode – Connecton mode 0 – manual 1 – priority 2 – last connected	Set auto switch mode for HDMI OUT 1 (last connected): #X-AV-SW-MODE out.hdmi.1.video.1,2<CR>

Function	Description	Syntax	Response	Parameters/Attributes	Example
X-AV-SW-MODE?	Get auto-switch mode. NOTE: This is an Extended Protocol 3000 command.	#X-AV-SW-MODE? <direction_type>.<port_format>.<port_index>.<signal_type>.<index><CR>	~nn@X-AV-SW-MODE <direction_type>.<port_format>.<port_index>.<signal_type>.<index>.<connection_mode><CR><LF>	The following attributes comprise the signal ID: <direction_type> – Direction of the port: IN – Input OUT – Output BOTH – Bi-directional (e.g. for RS-232) <port_format> – Type of signal on the port: HDMI ANALOG_AUDIO STREAM <port_index> – The port number as printed on the front or rear panel. <signal_type> – Signal ID attribute: VIDEO AUDIO <index> – Indicates a specific channel number when there are multiple channels of the same type. connection_mode – Connector mode 0 – manual 1 – priority 2 – last connected	Get auto switch mode for HDMI OUT 1: #X-AV-SW-MODE? out.hdmi.1.video.1<CR>
X-MUTE	Set mute ON/OFF on a specific signal.	#X-MUTE <direction_type>.<port_format>.<port_index>.<signal_type>.<index>.<state><CR>	~nn@ X-MUTE <direction_type>.<port_format>.<port_index>.<signal_type>.<index>.<state><CR><LF>	<direction_type> – Direction of the port: OUT – Output <port_format> – Type of signal on the port: HDMI ANALOG_AUDIO STREAM ALL – All audio output <port_index> – The port number as printed on the front or rear panel <signal_type> – Signal ID attribute: AUDIO <index> – Indicates a specific channel number when there are multiple channels of the same type state – OFF/ON (not case sensitive)	Mute the audio on HDMI OUT 1: #X-MUTE out.hdmi.1.audio.1,on<CR> Mute the audio on ALL OUT: #X-MUTE out.all.1.audio.1,on<CR>
X-MUTE?	Get mute ON/OFF on a specific signal.	#X-MUTE? <direction_type>.<port_format>.<port_index>.<signal_type>.<index><CR>	~nn@ X-MUTE <direction_type>.<port_format>.<port_index>.<signal_type>.<index>.<state><CR><LF>	<direction_type> – Direction of the port: OUT – Output <port_format> – Type of signal on the port: HDMI ANALOG_AUDIO STREAM ALL – All audio output <port_index> – The port number as printed on the front or rear panel <signal_type> – Signal ID attribute: AUDIO <index> – Indicates a specific channel number when there are multiple channels of the same type state – OFF/ON (not case sensitive)	Get the mute state of audio on HDMI OUT 1: #X-MUTE? out.hdmi.1.audio.1<CR>
X-PRIORITY	Set priority order.	#X-PRIORITY <direction_type>.<port_format>.<port_index>.<signal_type>.[<direction_type>.<port_format>.<port_index>.<signal_type>]...<CR>	~nn@X-PRIORITY <direction_type>.<port_format>.<port_index>.<signal_type>.[<direction_type>.<port_format>.<port_index>.<signal_type>]...<CR><LF>	<direction_type> – Direction of the port: IN – Input OUT – Output <port_format> – Type of signal on the port: HDMI USB_C ANALOG_AUDIO STREAM <port_index> – The port number as printed on the front or rear panel <signal_type> – Signal ID attribute: VIDEO AUDIO	Set video priority is 3,2,1 #X-PRIORITY out.hdmi.1.video.[in.usb_c.3.video.in.hdmi.2.video.in.hdmi.1.video]<CR>
X-PRIORITY?	Get priority order.	#X-PRIORITY? <direction_type>.<port_format>.<port_index>.<signal_type><CR>	~nn@X-PRIORITY <direction_type>.<port_format>.<port_index>.<signal_type>.[<direction_type>.<port_format>.<port_index>.<signal_type>]...<CR><LF>	<direction_type> – Direction of the port: IN – Input OUT – Output <port_format> – Type of signal on the port: HDMI USB_C ANALOG_AUDIO STREAM <port_index> – The port number as printed on the front or rear panel <signal_type> – Signal ID attribute: VIDEO AUDIO	Get video priority #X-PRIORITY? out.hdmi.1.video<CR>
X-ROUTE	Send routing command. NOTE: It is recommended to use the command #SIGNALS-LIST to get the list of all signal IDs available in the system and which can be used in this command. Video 1 is the default port in this command and is implied even if not written: #X-ROUTE out.hdmi.1.in.video.1<CR> is interpreted as: #X-ROUTE out.hdmi.1.video.1.in.hdmi.1.video.1<CR> This is an Extended Protocol 3000 command. Brackets '[' and ']' are reserved Protocol 3000 characters that define a list of parameters as in [a,b,c,d].	#X-ROUTE [<direction_type1>.<port_type1>.<port_index1>.<signal_type1>.<index1>,...].<direction_type2>.<port_type2>.<port_index2>.<signal_type2>.<index2><CR>	~nn@X-ROUTE [<direction_type1>.<port_type1>.<port_index1>.<signal_type1>.<index1>,...].<direction_type2>.<port_type2>.<port_index2>.<signal_type2>.<index2><CR><LF>	The following attributes comprise the signal ID: <direction_type> – Direction of the port: IN – Input OUT – Output BOTH – Bi-directional (e.g. for RS-232) <port_format> – Type of signal on the port: HDMI ANALOG_AUDIO STREAM <port_index> – The port number as printed on the front or rear panel <signal_type> – Signal ID attribute: VIDEO AUDIO <index> – Indicates a specific channel number when there are multiple channels of the same type.	Route HDMI IN 2 to HDMI OUT 1: #X-ROUTE out.hdmi.1.video.1.in.hdmi.2.video.1<CR> Route of audio hdmi.1.audio.1 signal to HDMI output, analog: #X-ROUTE [out.hdmi.1.audio.1,out.analog.audio.1.audio.1],in.hdmi.1.audio.1<CR>

Function	Description	Syntax	Response	Parameters/Attributes	Example
X-ROUTE?	Get routing status. NOTE: It is recommended to use the command #SIGNALS-LIST to get the list of all signal IDs available in the system and which can be used in this command. VIDEO.1 are the default <signal_type> and <index> in this command and are implied even if not written: #X-ROUTE out.hDMI.1,in.video.1<CR> is interpreted as: #X-ROUTE out.hDMI.1.video.1,in.hDMI.1.video.1<CR> This is an Extended Protocol 3000 command.	#X-ROUTE? <direction_type1>.<port_type1>.<port_index1>.<signal_type1>.<index1><CR>	~nn@X-ROUTE <direction_type1>.<port_type1>.<port_index1>.<signal_type1>.<index1>,<direction_type2>.<port_type2>.<port_index2>.<signal_type2>.<index2><CR><LF>	The following attributes comprise the signal ID: <direction_type> – Direction of the port: IN – Input OUT – Output BOTH – Bi-directional (e.g. for RS-232) <port_format> – Type of signal on the port: HDMI ANALOG_AUDIO STREAM <port_index> – The port number as printed on the front or rear panel <signal_type> – Signal ID attribute: VIDEO AUDIO <index> – Indicates a specific channel number when there are multiple channels of the same type.	Get the routing status: #X-ROUTE? out.hDMI.1.video.1<CR>

Result and Error Codes

Syntax

In case of an error, the device responds with an error message. The error message syntax:

- **~NN@ERR XXX<CR><LF>** – when general error, no specific command
- **~NN@CMD ERR XXX<CR><LF>** – for specific command
- **NN** – machine number of device, default = 01
- **XXX** – error code

Error Codes

Error Name	Error Code	Description
P3K_NO_ERROR	0	No error
ERR_PROTOCOL_SYNTAX	1	Protocol syntax
ERR_COMMAND_NOT_AVAILABLE	2	Command not available
ERR_PARAMETER_OUT_OF_RANGE	3	Parameter out of range
ERR_UNAUTHORIZED_ACCESS	4	Unauthorized access
ERR_INTERNAL_FW_ERROR	5	Internal FW error
ERR_BUSY	6	Protocol busy
ERR_WRONG_CRC	7	Wrong CRC
ERR_TIMEDOUT	8	Timeout
ERR_RESERVED	9	(Reserved)
ERR_FW_NOT_ENOUGH_SPACE	10	Not enough space for data (firmware, FPGA...)
ERR_FS_NOT_ENOUGH_SPACE	11	Not enough space – file system
ERR_FS_FILE_NOT_EXISTS	12	File does not exist
ERR_FS_FILE_CANT_CREATED	13	File can't be created
ERR_FS_FILE_CANT_OPEN	14	File can't open
ERR_FEATURE_NOT_SUPPORTED	15	Feature is not supported
ERR_RESERVED_2	16	(Reserved)
ERR_RESERVED_3	17	(Reserved)
ERR_RESERVED_4	18	(Reserved)
ERR_RESERVED_5	19	(Reserved)
ERR_RESERVED_6	20	(Reserved)
ERR_PACKET_CRC	21	Packet CRC error
ERR_PACKET_MISSED	22	Packet number isn't expected (missing packet)
ERR_PACKET_SIZE	23	Packet size is wrong
ERR_RESERVED_7	24	(Reserved)
ERR_RESERVED_8	25	(Reserved)
ERR_RESERVED_9	26	(Reserved)
ERR_RESERVED_10	27	(Reserved)
ERR_RESERVED_11	28	(Reserved)
ERR_RESERVED_12	29	(Reserved)
ERR_EDID_CORRUPTED	30	EDID corrupted
ERR_NON_LISTED	31	Device specific errors
ERR_SAME_CRC	32	File has the same CRC – not changed
ERR_WRONG_MODE	33	Wrong operation mode
ERR_NOT_CONFIGURED	34	Device/chip was not initialized

The warranty obligations of Kramer Electronics Inc. ("Kramer Electronics") for this product are limited to the terms set forth below:

What is Covered

This limited warranty covers defects in materials and workmanship in this product.

What is Not Covered

This limited warranty does not cover any damage, deterioration or malfunction resulting from any alteration, modification, improper or unreasonable use or maintenance, misuse, abuse, accident, neglect, exposure to excess moisture, fire, improper packing and shipping (such claims must be presented to the carrier), lightning, power surges, or other acts of nature. This limited warranty does not cover any damage, deterioration or malfunction resulting from the installation or removal of this product from any installation, any unauthorized tampering with this product, any repairs attempted by anyone unauthorized by Kramer Electronics to make such repairs, or any other cause which does not relate directly to a defect in materials and/or workmanship of this product. This limited warranty does not cover cartons, equipment enclosures, cables or accessories used in conjunction with this product.

Without limiting any other exclusion herein, Kramer Electronics does not warrant that the product covered hereby, including, without limitation, the technology and/or integrated circuit(s) included in the product, will not become obsolete or that such items are or will remain compatible with any other product or technology with which the product may be used.

How Long this Coverage Lasts

The standard limited warranty for Kramer products is seven (7) years from the date of original purchase, with the following exceptions:

1. All Kramer VIA hardware products are covered by a standard three (3) year warranty for the VIA hardware and a standard three (3) year warranty for firmware and software updates; all Kramer VIA accessories, adapters, tags, and dongles are covered by a standard one (1) year warranty.
2. Kramer fiber optic cables, adapter-size fiber optic extenders, pluggable optical modules, active cables, cable retractors, ring mounted adapters, portable power chargers, Kramer speakers, and Kramer touch panels are covered by a standard one (1) year warranty. Kramer 7-inch touch panels purchased on or after April 1st, 2020 are covered by a standard two (2) year warranty.
3. All Kramer Calibre products, all Kramer Minicom digital signage products, all HighSecLabs products, all streaming, and all wireless products are covered by a standard three (3) year warranty.
4. All Sierra Video MultiViewers are covered by a standard five (5) year warranty.
5. Sierra switchers & control panels are covered by a standard seven (7) year warranty (excluding power supplies and fans that are covered for three (3) years).
6. K-Touch software is covered by a standard one (1) year warranty for software updates.
7. All Kramer passive cables are covered by a lifetime warranty.

Who is Covered

Only the original purchaser of this product is covered under this limited warranty. This limited warranty is not transferable to subsequent purchasers or owners of this product.

What Kramer Electronics Will Do

Kramer Electronics will, at its sole option, provide one of the following three remedies to whatever extent it shall deem necessary to satisfy a proper claim under this limited warranty:

1. Elect to repair or facilitate the repair of any defective parts within a reasonable period of time, free of any charge for the necessary parts and labor to complete the repair and restore this product to its proper operating condition. Kramer Electronics will also pay the shipping costs necessary to return this product once the repair is complete.
2. Replace this product with a direct replacement or with a similar product deemed by Kramer Electronics to perform substantially the same function as the original product. If a direct or similar replacement product is supplied, the original product's end warranty date remains unchanged and is transferred to the replacement product.
3. Issue a refund of the original purchase price less depreciation to be determined based on the age of the product at the time remedy is sought under this limited warranty.

What Kramer Electronics Will Not Do Under This Limited Warranty

If this product is returned to Kramer Electronics or the authorized dealer from which it was purchased or any other party authorized to repair Kramer Electronics products, this product must be insured during shipment, with the insurance and shipping charges prepaid by you. If this product is returned uninsured, you assume all risks of loss or damage during shipment. Kramer Electronics will not be responsible for any costs related to the removal or re-installation of this product from or into any installation. Kramer Electronics will not be responsible for any costs related to any setting up this product, any adjustment of user controls or any programming required for a specific installation of this product.

How to Obtain a Remedy Under This Limited Warranty

To obtain a remedy under this limited warranty, you must contact either the authorized Kramer Electronics reseller from whom you purchased this product or the Kramer Electronics office nearest you. For a list of authorized Kramer Electronics resellers and/or Kramer Electronics authorized service providers, visit our web site at www.kramerav.com or contact the Kramer Electronics office nearest you.

In order to pursue any remedy under this limited warranty, you must possess an original, dated receipt as proof of purchase from an authorized Kramer Electronics reseller. If this product is returned under this limited warranty, a return authorization number, obtained from Kramer Electronics, will be required (RMA number). You may also be directed to an authorized reseller or a person authorized by Kramer Electronics to repair the product.

If it is decided that this product should be returned directly to Kramer Electronics, this product should be properly packed, preferably in the original carton, for shipping. Cartons not bearing a return authorization number will be refused.

Limitation of Liability

THE MAXIMUM LIABILITY OF KRAMER ELECTRONICS UNDER THIS LIMITED WARRANTY SHALL NOT EXCEED THE ACTUAL PURCHASE PRICE PAID FOR THE PRODUCT. TO THE MAXIMUM EXTENT PERMITTED BY LAW, KRAMER ELECTRONICS IS NOT RESPONSIBLE FOR DIRECT, SPECIAL, INCIDENTAL OR CONSEQUENTIAL DAMAGES RESULTING FROM ANY BREACH OF WARRANTY OR CONDITION, OR UNDER ANY OTHER LEGAL THEORY. Some countries, districts or states do not allow the exclusion or limitation of relief, special, incidental, consequential or indirect damages, or the limitation of liability to specified amounts, so the above limitations or exclusions may not apply to you.

Exclusive Remedy

TO THE MAXIMUM EXTENT PERMITTED BY LAW, THIS LIMITED WARRANTY AND THE REMEDIES SET FORTH ABOVE ARE EXCLUSIVE AND IN LIEU OF ALL OTHER WARRANTIES, REMEDIES AND CONDITIONS, WHETHER ORAL OR WRITTEN, EXPRESS OR IMPLIED. TO THE MAXIMUM EXTENT PERMITTED BY LAW, KRAMER ELECTRONICS SPECIFICALLY DISCLAIMS ANY AND ALL IMPLIED WARRANTIES, INCLUDING, WITHOUT LIMITATION, WARRANTIES OF MERCHANTABILITY AND FITNESS FOR A PARTICULAR PURPOSE. IF KRAMER ELECTRONICS CANNOT LAWFULLY DISCLAIM OR EXCLUDE IMPLIED WARRANTIES UNDER APPLICABLE LAW, THEN ALL IMPLIED WARRANTIES COVERING THIS PRODUCT, INCLUDING WARRANTIES OF MERCHANTABILITY AND FITNESS FOR A PARTICULAR PURPOSE, SHALL APPLY TO THIS PRODUCT AS PROVIDED UNDER APPLICABLE LAW. IF ANY PRODUCT TO WHICH THIS LIMITED WARRANTY APPLIES IS A "CONSUMER PRODUCT" UNDER THE MAGNUSON-MOSS WARRANTY ACT (15 U.S.C.A. §2301, ET SEQ.) OR OTHER APPLICABLE LAW, THE FOREGOING DISCLAIMER OF IMPLIED WARRANTIES SHALL NOT APPLY TO YOU, AND ALL IMPLIED WARRANTIES ON THIS PRODUCT, INCLUDING WARRANTIES OF MERCHANTABILITY AND FITNESS FOR THE PARTICULAR PURPOSE, SHALL APPLY AS PROVIDED UNDER APPLICABLE LAW.

Other Conditions

This limited warranty gives you specific legal rights, and you may have other rights which vary from country to country or state to state.

This limited warranty is void if (i) the label bearing the serial number of this product has been removed or defaced, (ii) the product is not distributed by Kramer Electronics or (iii) this product is not purchased from an authorized Kramer Electronics reseller. If you are unsure whether a reseller is an authorized Kramer Electronics reseller, visit our web site at www.kramerav.com or contact a Kramer Electronics office from the list at the end of this document.

Your rights under this limited warranty are not diminished if you do not complete and return the product registration form or complete and submit the online product registration form. Kramer Electronics thanks you for purchasing a Kramer Electronics product. We hope it will give you years of satisfaction.



HDMI™
HIGH-DEFINITION MULTIMEDIA INTERFACE



P/N: 2900-301580

Rev: 2



SAFETY WARNING

Disconnect the unit from the power supply before opening and servicing

For the latest information on our products and a list of Kramer distributors, visit our website where updates to this user manual may be found.

We welcome your questions, comments, and feedback.

The terms HDMI, HDMI High-Definition Multimedia Interface, and the HDMI Logo are trademarks or registered trademarks of HDMI Licensing Administrator, Inc. All brand names, product names, and trademarks are the property of their respective owners.