

GVM[®]

Great Video Maker

GVM-PD60B

CONTENTS

Important Safety Instructions -----	Page 1~2
Warning -----	Page 2
Product Introduction -----	Page 3
Disclaimers -----	Page 3
Product Parameter -----	Page 4
Precautions -----	Page 4
Product Structure Analysis -----	Page 5
Installation Method -----	Page 5~6
Description Of Product Control Keys -----	Page 6
Function Introduction & Instructions For Use -----	Page 7~8
Firmware Upgrade -----	Page 8
APP Control -----	Page 9~10
Use And Preservation -----	Page 10
Quick Troubleshooting -----	Page 11
Packing List -----	Page 11
Product Warranty -----	Page 12~13

IMPORTANT SAFETY INSTRUCTIONS





First and foremost: this product is professional lighting and staging equipment and should be used by a professional lighting technician or under the guidance of a professional. When using this product, you must always follow the cautions below:

1. Read the product manual carefully before use.
2. This product is only suitable to use in a temperature range of -10°C to 40°C.
3. Do not place the equipment near flammable and volatile solvents such as alcohol and gasoline.
4. Before storing the device, make sure it has cooled down completely. When being stored, unplug the power cord from the device. The equipment should be stored in its carrying case or a well-ventilated and dry place.
5. This lighting fixture is not for general illumination and should not be used as such. Individuals with eye injuries or sensitivity should avoid using this lighting fixture.
6. This is a professional light and children are prohibited from using it. Parents or guardians must closely supervise children when they are near the equipment to prevent personal injury caused by colliding with or misusing the equipment.
7. Before using the equipment, please remove the protective cover.
8. When the lighting fixture is on, it is forbidden to stare directly at the light source under any circumstances. High-intensity lighting should only be used under the guidance of a professional lighting technician. Avoid staying in a high-intensity light environment for a long time. If feeling any discomfort, please immediately turn off the lighting fixture, and seek medical attention.
9. When the lighting fixture is on, use it carefully and avoid contacting high-temperature components such as LED light sources to prevent being burnt.
10. Do not use damaged equipment or accessories. Wait for a professional repairman to inspect and repair it before it is confirmed that the equipment can function normally.
11. If the light source is damaged or deformed due to heat, please stop using it and contact the manufacturer, service agents, or qualified repairman promptly to replace the light source to avoid accidents.
12. If the product is cracked due to falling, squeezing, or strong impact during use, please stop use it to avoid being electrically shocked by touching internal electronic components.
13. Do not disassemble the product by yourself. If the product malfunctions, it must be checked and repaired by the manufacturer or authorized repair personnel.
14. Before cleaning and maintenance, be sure to unplug the power supply. To unplug never pull on the cable but always pull the plug itself. This device shall only operate with earthed power outlets or emergency power generators.
15. When cleaning the device, do not wipe it with a wet cloth. Use a dry and soft cloth to wipe off the dirt.
16. If an extension cord is required, it needs to have the necessary capacity to power the respective unit. Using an extension cord with a lower current capacity than the devices need may cause overheating.

17. For some products with long power cords, please place the power cords properly and avoid contact with overheated surfaces that may damage or trip personnel. Please use the original power cords of our manufactory. The damage caused by using non-original power cords is not covered by our repair service.
18. Do not use product accessories that are not recommended by our brand to avoid fire, electric shock, or personal injury.
19. Some products use batteries for power supply. Do not use any batteries, power sources, or accessories that are not specified in the user manual. Please keep batteries and other accessories out of reach of children and infants. If a child or infant swallows a battery or accessory, seek medical attention immediately. If the battery leaks, changes color, deforms, smokes, or emits an odor, remove it immediately. Be careful not to get burned during the removal. Continued use of such batteries may cause a fire, electric shock, or skin burns. Do not use any deformed or modified batteries. Do not disassemble or modify this product or the battery. Do not heat the battery or solder it. Do not let the battery come into contact with fire or water, or subject it to strong external force. Do not insert the battery's positive and negative ends incorrectly, or mix and use old and new batteries or different types of batteries.
20. For some products with built-in lithium batteries, please use a dedicated charger for charging, and following the correct operating instructions within the prescribed voltage and temperature range.
21. The warranty last for one year. Consumables like batteries, adapters, power cords, and other accessories are not covered by the warranty.
22. The one-year warranty will be invalidated if the equipment is found to have been repaired privately. The related repair costs will be charged.
23. Equipment malfunctions caused by non-standard operations are not covered by the warranty.
24. The safety instructions are based on our factory's strict testing. If there are any changes in the equipment's design and specifications, we reserve the right not to notify you. Customers can visit our official website to check the latest digital version of the instructions and learn about the newest product information.

Keep these instructions!

WARNING:

-  High-power LED lights are strictly prohibited from being directly viewed or shining into other people's eyes.
-  Do not unplug the power cord or connecting wires while the light is on to avoid personal injury.
-  Do not cover the heat dissipation port when the lamp is in operation.
-  Keep children away from touching or using this light.
-  As professional lighting equipment, please make sure to operate it correctly according to the user manual.

PRODUCT INTRODUCTION

Thank you for purchasing our "GVM-PD60B". This product is specially designed for photography and videography enthusiasts in mind. This product is suitable for use in live stream / outdoors / studio settings, and can also be used in YouTube video shooting.

The main features of the product are:

1. It has 3 light effect modes: CCT mode, Source mode, and FX mode.
CCT mode: Adjustable color temperature and brightness.
Source mode: This mode provides 12 light source types: Tungsten, HMI 5600, HMI 6000, Studio Lamps, Sodium Lamp, Halogen, Arc Lamp, Candle, Sunset/Sunrise, Daylight, Overcast Sky, CFL Cool White. This saves a lot of adjusting time when you need a specific light source.
FX mode: This mode provides 12 light effect types: Lightning, CCT Loop, Candle, Bad Bulb, TV, Paparazzi, Explosion, Pulsing, Strobe, Fire, Fireworks, Welding. This is a useful feature that can save you time when you want to set up a specific mood.
2. APP control: Light can be controlled through your IOS and Android smart mobile devices; it also supports Bluetooth mesh networking and can be group controlled with GVM brand devices that support mesh networking.
3. It features LED chips with a high CRI rating of 97+. Which can help restore and enrich the colors of objects, providing you with natural and vivid light effects.

We firmly believe that the correct use of this product will be of great help to your production workflow. It is strongly recommended that you read the following user guide carefully before using this product.

DISCLAIMERS

1. Before using this product, please read the text carefully to ensure that the correct operation of the product has been carried out. Failure to follow and not following the instructions and warnings in this document may cause harm to you and others around you, or even damage the product or other surrounding items.
2. By using this product, you are deemed to have carefully read the disclaimer and warning, understand and acknowledge all the terms and contents of this statement, and promise to take full responsibility for the use of this product and the possible consequences.
3. Design and specifications are subject to change without notice.

PRODUCT PARAMETER

- ◆ Brand: GVM
- ◆ Product Model: GVM-PD60B
- ◆ Product Name: Video Light
- ◆ Product Type: LED Video Fill Light
- ◆ Functional Features: Multiple Light Effect Modes, High CRI LED Chips, Waterproof Light Body, Rechargeable battery.
- ◆ Control Method: On Board Control, APP Control, Bluetooth Mesh Networking
- ◆ Light Adjustment Method: Step-less Adjustment
- ◆ CRI: ≥ 97
- ◆ Color Temperature: 2700K~6800K
- ◆ Illuminance: Bare Light 8290 Lux@0.5m, 2100 Lux@1m;
Plus Standard Reflector 49300 Lux@0.5m, 9240 Lux@1m
- ◆ Power: 60W
- ◆ Weight: 1.26KG
- ◆ Product Size (mm): 273×76×72
- ◆ Light Body Waterproof Rating: IP25
- ◆ Number Of LED Chips: 1 (COB LED Chip)
- ◆ Power Supply Mode: Lithium Battery Power Supply
- ◆ Battery Capacity: 14.8V6600mAh
- ◆ Support: PD2.0/PD3.0 bidirectional input and output protocol
- ◆ Output Support: 5V/3A, 9V/3A, 12V/3A, 15V/3A, 20V/3A
- ◆ Input Support: 5V, 9V, 12V, 15V, 20V (Can be used while charging.)
(Note: No charger is provided, you need to purchase it yourself.)
- ◆ Cooling Method: Heat Sink + Cooling Fan
- ◆ Product Material: Aluminum Alloy
- ◆ Product Origin: Huizhou, China

PRECAUTIONS

1. The product is not anti-corrosion, therefore do not let the product touch any corrosive liquid.
2. When using the product, make sure the product is put firmly and prevents falling and damage.
3. If the product will not be used for a long time, please switch off the power to reduce energy loss.
4. If the product needs to be used while charging, the input must use a protocol charger that supports 20V5A.

PRODUCT STRUCTURE DIAGRAM

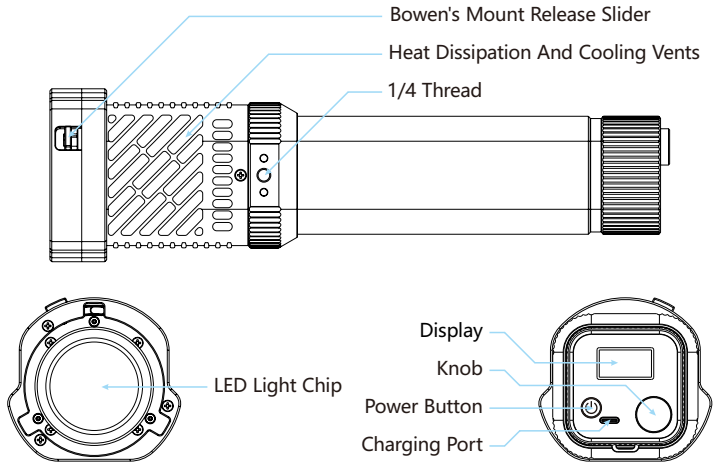

INSTALLATION METHOD

- 1 Insert the standard cover into the socket of the light accordingly, and then turn it slightly clockwise to lock the Bowen's reflector to the light. Push the slider back and rotate the Bowen's reflector counterclockwise to remove it from the light.

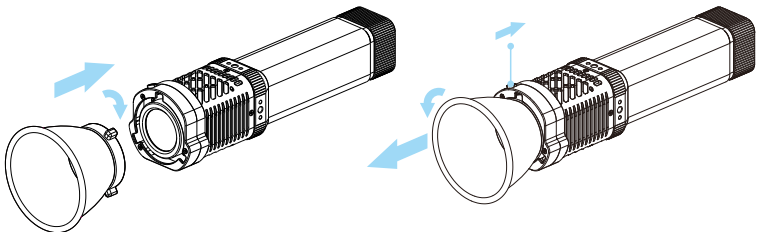

- 2 Turn the knob clockwise to fix the lamp on the handle, turn it counterclockwise to remove it.

Slide the angle adjustment button downward to adjust the angle of the light.

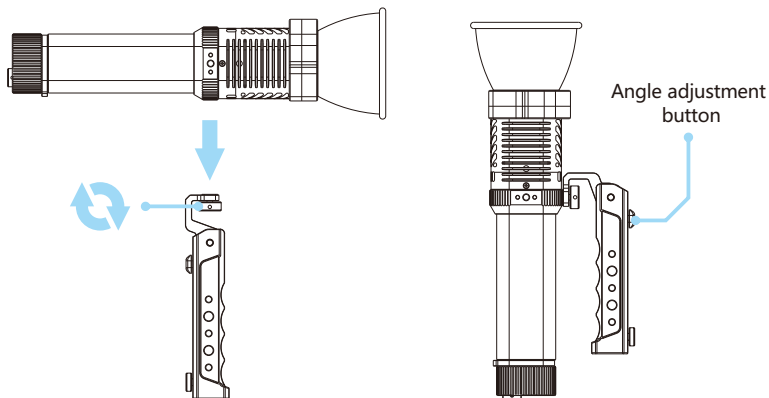

DESCRIPTION OF PRODUCT CONTROL KEYS

- 1 Charging port: Use a Type-C universal charger to connect to this port for charging and firmware update.
- 2 ON/OFF key: Press and hold for 2 seconds to turn ON/OFF the light.
- 3 Display: Shows current settings, modes and parameters.

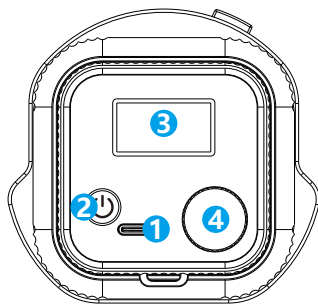

- 4 Knob: **【Rotate the knob】** Select menus, mode or adjust parameters.
【Click the knob】 Enter the menu or confirm the selection.
【Double-click the knob】 Return to the previous menu.
【Long press the knob】 Return to the main menu.

FUNCTION INTRODUCTION & INSTRUCTIONS FOR USE

① LIGHT:

There are 3 lighting modes: CCT, light source, and light effect.



CCT: Allow you to adjust color temperature and brightness of the light.

INT: Short press and rotate the knob to adjust the brightness of the light.

CCT: Short press and turn the knob to adjust the color temperature of the light.

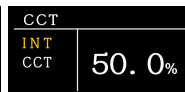

Source: Has 12 types of light sources:

Tungsten, HMI 5600, HMI 6000, Studio Lamps, Sodium Lamp, Halogen, Arc Lamp, Candle, Sunset/Sunrise, Daylight, Overcast Sky, CFL Cool White.

Source: Short press and turn the knob to select the light source.

INT: After selecting the light source, rotate the knob to adjust its brightness.



FX: Has 12 light effect types:

Lightning, CCT Loop, Candle, Bad Bulb, TV, Paparazzi, Explosion, Pulsing, Strobe, Fire, Fireworks, Welding.

Light effect: Short press and turn the knob to select light effect.

INT: After selecting the light effect, rotate the knob to adjust its brightness.

CCT: Short press and turn the knob to adjust the color temperature.

SPD: Short press and turn the knob to adjust the speed of light effects.



② FAN SETTINGS:

You can view and change the current fan mode from:

Smart, High, Silent.

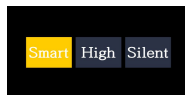

③ BLUETOOTH:

You can check the current Bluetooth status, turn the Bluetooth function on/off, and reset Bluetooth.



④ BATTERY:

Switch off the Power Save mode: Operate at maximum power output.

Switch on the Power Save mode: Automatically reduce the power output when the remaining battery level is lower than 40%.



⑤ SETTINGS:

The menu setting page includes: Language, Products, TEMP, and Reset.



Language: Supports switching between Chinese and English.

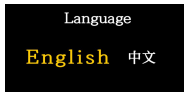

Products: Displays the product's firmware version and hardware version information.



TEMP: You can check the current operating temperature of the light body.

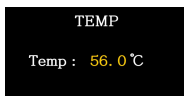

Reset: Factory settings can be restored.

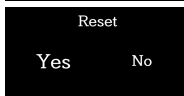

FIRMWARE UPDATE

1. Download the new firmware file from the official website (Specific address <https://gvmlcd.com/firmware-upgrade>).
2. Unzip the downloaded file to the root directory of the USB flash drive.
3. Insert the USB Drive into the TYPE-C port of the light body through the USB to TYPE-C adapter.
4. Press the power button and the knob at the same time, then release the power button and keep pressing the knob until the update prompt appears on the screen.
5. When the "Upgrade success!!!" text appears on the screen, that means the upgrade is successful.
6. Unplug the USB flash drive and restart the device to complete the upgrade.

APP CONTROL

APP Download Method

(Scan the QR code on the back of the manual to download the APP)

Android Device: Official website QR code, Google Play, Huawei Store, etc.

iOS Device: App Store

Device-adding

1. Before adding a device, please make sure you have turned on your phone's Bluetooth and network data, accessibility to Bluetooth and network data, then reset the lighting device's Bluetooth.
2. Click the "Add Device" button on the "My Devices" page to find the Bluetooth light devices that have been turned on nearby. (Figure 1)
3. Select the device to be connected for pairing. (Figure 2)

* Android requires location permissions to be turned on in order to connect your device using mesh technology, and we do not collect any of your location information during this process.

Device Management

1. After successfully adding your lighting device, your device will be displayed in the "My Devices" list. (Figure 3)
2. Click on the Device to access the device control. (Figure 4)

Figure 1

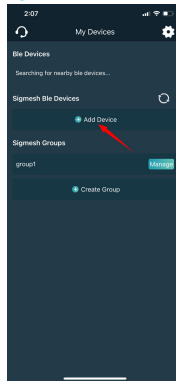

Figure 2

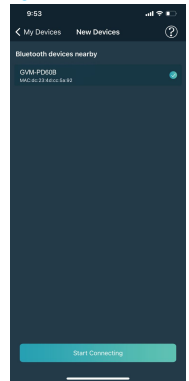
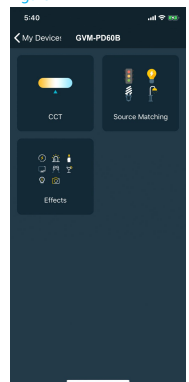

Figure 3



Figure 4



Account Login

- ◆ Use e-mail to get the verification code to log in (the first login automatically registers the account). (Figure 5)
- ◆ There may be a delay in sending the verification code, and the speed of delivery depends on the e-mail server you are using.
- ◆ Some email servers may recognize our verification emails as advertising promotions, please check your spam folder/inbox.
- ◆ After logging in, you can synchronize the Mesh Bluetooth devices bound to the current account to other smart devices.

Figure 5

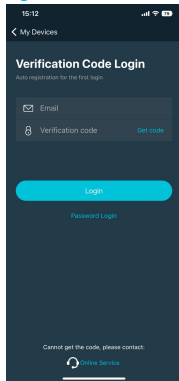

USE AND PRESERVATION

Do not place the product in a high humidity, strong electromagnetic field, direct sunlight, or high-temperature environment. If the product will not be used for a long time, please disconnect its power and remove the battery.

Clean: Before cleaning, disconnect the power plug. And use a damp cloth instead of any detergent or soluble liquids to avoid damaging the surface layer.

Power: Make sure the power is within the demanded range, not too high or too low.

Repairing: If there is a fault or performance degradation, do not unpack the shell by yourself, avoiding damage to the machine and losing the right of maintenance. When there is a fault, do not hesitate to contact us, and we will do our best to deal with the problem.

Accessories: Please use the accessories provided by the manufacturer and approved ones, to maximize the performance.

Warranty: Do not modify the product, or you will lose the right to maintenance.

QUICK TROUBLESHOOTING

Issue	Check the product	Troubleshooting
The indicator does not light up.	When using a lithium battery to supply power, make sure that the battery does not have "low battery" protection.	Use the product after recharging the batteries.
While using the APP to add a device, the Bluetooth of the device cannot be found.	Check if the device is turned on properly and that it is not already paired by someone else connection.	Follow these steps: 1. Turn on phone's Bluetooth and network data function, android devices need to turn on the GPS positioning. 2. Allow access to Bluetooth and network data, GPS positioning. 3. Reset the device Bluetooth according to the user manual.
The APP failed to pair to a device.	Check if the device is turned on properly and has not been connected or paired by others; Check if the Bluetooth and network conditions of the cell phone are good.	Reset the device Bluetooth and restart the app then try to connect again.
The device is no longer searchable after removing it from the APP.	Check if the device have been removed while it is off-lined or in poor network conditions.	Reset the device Bluetooth and then search again to add the device.
In-app device controls can not be accessed.	Check if the device is online (small green light displayed); If it's off-line, please advice to the Distribution Network Connection Failure steps.	Reboot the device, wait for 5 seconds, wait till it shows as online status. To control it; Reset the device Bluetooth and then add the device back to the device list.
No response from the device.	Check whether the device is connected to the APP. If it is connected, the Bluetooth icon will appear on the upper right side of the display.	1. If the APP is connected, wait 5 seconds without operating the APP until the Bluetooth icon disappears to resume; 2. If the APP is not connected, press the power button and knob at the same time to restart the device.

PACKING LIST

Name	Quantity	Notes
LED Video Lights	1	
Bowen's Reflector	1	
Handle	1	
Type-C Charging Cable	1	
Carrying Bag	1	
User Manual	1	

PRODUCT WARRANTY

Dear user, this warranty card is important proof for applying for warranty service. Please cooperate with the salesperson to fill it out and keep it properly. Thank you!

Product Information	Model Number	Product Barcode
User Information	Name	Contact Number
	Mailing Address	
Seller Information	Name	
	Contact Number	
	Mailing Address	
	Sales Date	
Remarks		

Note: this form should be confirmed by the salesperson's stamp.

Applicable Products

This document applies to the products listed in the relevant "Product Warranty Information" (see instructions below). Other products or components that do not fall within this scope (such as promotional products, gift items, and other components added after the factory) are not covered by this warranty promise.

Warranty Period

The corresponding warranty period for products and components shall be executed according to the relevant "Product Warranty Information". The warranty period starts from the first day of purchase of the product, and the date of registration on the warranty card at the time of purchase shall prevail.

How to Obtain Warranty Service

You can directly contact the product salesperson or authorized service agency, or call GVM's after-sales service hotline to contact us and have our service personnel arrange service for you. When applying for warranty service, you should provide a valid warranty card as a warranty certificate to be eligible for warranty service. If you cannot provide a valid warranty card, we may also provide you with warranty service under the circumstance that our products or components are confirmed to be within the warranty scope, but this is not our obligation.

Cases where warranty does not apply:

If the product meets the following conditions, the warranty and service under this document will not apply:

1. The product or parts have exceeded the corresponding warranty period.
2. Malfunctions or damages caused by incorrect or improper use, maintenance, or storage, such as improper handling, use for purposes other than the reasonable expectations of the product, incorrect insertion or removal of external devices, falling or crushing due to external force, or exposure to inappropriate temperature, solvents, acids, alkalis, water immersion, or damp environments.
3. Malfunctions or damages caused by unauthorized installation, repair, modification, addition, or disassembly by institutions or personnel not authorized by GVM.
4. Modifications, changes, or removals of the original identification information of the product or its parts.
5. Lack of valid warranty card.
6. Malfunctions or damages caused by the use of unauthorized, non-standard or non-publicly released software.
7. Malfunctions or damages caused by force majeure or accidents.
8. Other malfunctions or damages not caused by quality issues of the product itself. In such cases, you should seek solutions from the relevant responsible parties, and GVM will not be held liable. Malfunctions or damages caused by components, accessories, or software not covered by the warranty or beyond the warranty scope that renders the product unable to function properly are not covered by the warranty. Fading, wear, and consumption that is normal during the product usage process are not covered by the warranty.

Product Warranty and Service Support Information

The product warranty period and service types are implemented according to the following "Product Warranty Information" for each product category, component, and optional equipment:

Product Category	Accessories Name	Warranty Period(Month)	Warranty Service Type
Component	Circuit Board.	12 Month	Customer service repair
Other	Spotlight mount, softbox, adapter, Standard reflector, power cord, battery Handle, light stand, TYPE-C cable, battery slot, battery, Fresnel lens, grid, carrying bag and all other accessories, etc. Consumable or electrically sensitive parts are not covered by the warranty.	None	No Warranty

QC
PASS



GVM Official website



Facebook



Download APP

Huizhou City Latu Photographic Equipment Co., Ltd.

Web: www.gvmled.com

B&H Email: bh@gvmled.com

GVM Email: support@gvmled.com

Amazon Email: amazonsupport@gvmled.com

Warehouse Address: 12285 MCNULTY RD, STE 105 PHILADELPHIA, Pennsylvania 19154, USA