

Operating Instructions

Camera Control Unit

Model No.	AK-UCU700P
Model No.	AK-UCU700PS
Model No.	AK-UCU700E
Model No.	AK-UCU700ES
Model No.	AK-UCU710P
Model No.	AK-UCU710PS
Model No.	AK-UCU710E
Model No.	AK-UCU710ES

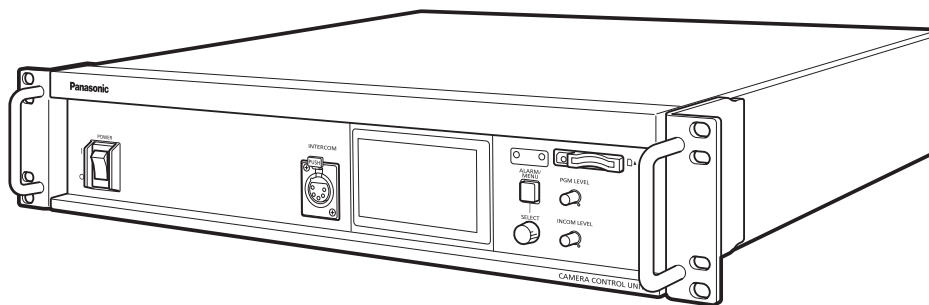

Please carefully read this manual, and save this manual for future use.
Before using this product, be sure to read "Read this first!" (pages 2 to 6).

Read this first!**WARNING:**

This equipment must be grounded. To ensure safe operation, the three-pin plug must be inserted only into a standard three-pin power outlet which is effectively grounded through normal household wiring.

Extension cords used with the equipment must have three cores and be correctly wired to provide connection to the ground. Wrongly wired extension cords are a major cause of fatalities.

The fact that the equipment operates satisfactorily does not imply that the power outlet is grounded or that the installation is completely safe. For your safety, if you are in any doubt about the effective grounding of the power outlet, please consult a qualified electrician.

WARNING:

- To reduce the risk of fire or electric shock, do not expose this equipment to rain or moisture.
- To reduce the risk of fire or electric shock, keep this equipment away from all liquids. Use and store only in locations which are not exposed to the risk of dripping or splashing liquids, and do not place any liquid containers on top of the equipment.

WARNING:

Always keep memory cards (optional accessory) and screws supplied with option boards (optional accessory) out of the reach of babies and small children.

WARNING:

Installation should only be performed by qualified installation personnel. Improper installation may result in the entire apparatus falling down and causing injury.

WARNING:

This equipment is compliant with Class A of CISPR 32. In a residential environment this equipment may cause radio interference.

CAUTION:

Do not remove panel covers by unscrewing. To reduce the risk of electric shock, do not remove the covers. No user serviceable parts inside. Refer servicing to qualified service personnel.

CAUTION:

To reduce the risk of fire or electric shock and annoying interference, use the recommended accessories only.

CAUTION:

In order to maintain adequate ventilation, do not install or place this unit in a bookcase, built-in cabinet or any other confined space. To prevent risk of electric shock or fire hazard due to overheating, ensure that curtains and any other materials do not obstruct the ventilation.

CAUTION:

The mains plug of the power supply cord shall remain readily operable.

The AC receptacle (mains socket outlet) shall be installed near the equipment and shall be easily accessible. To completely disconnect this equipment from the AC mains, disconnect the power cord plug from the AC receptacle.

CAUTION:

Invisible Laser radiation is emitted from the Optical fiber connector when this product is turned on. Don't look into directly into the Optical fiber connector of this product.

CAUTION:

This product uses a semiconductor laser system and is a Class 1 Laser Product complies with Radiation Performance Standards, 21CFR SUBCHAPTER J.

Use of controls or adjustments or performance of procedures other than those specified herein may result in hazardous radiation exposure.

Don't make any modifications.

Don't repair by yourself.

Refer servicing to qualified personnel.

CAUTION:

- Keep the temperature inside the rack to between 0 °C to 40 °C (32 °F to 104 °F).
- Bolt the rack securely to the floor so that it will not topple over when the unit is drawn out.

CAUTION:

Naked flame sources, such as lighted candles, should not be placed on the apparatus.

CAUTION:

To reduce the risk of fire or electric shock, refer mounting of the optional interface boards to qualified service personnel.

For U.S.A. and Canada**CAUTION:**

This apparatus can be operated at a voltage in the range of 100– 240 V AC.

Voltages other than 120 V are not intended for U.S.A. and Canada.

Operation at a voltage other than 120 V AC may require the use of a different AC plug. Please contact either a local or foreign Panasonic authorized service center for assistance in selecting an alternate AC plug.

NOTIFICATION (Canada)

CAN ICES-003 (A)/NMB-003(A)

For AK-UCU700P, AK-UCU700PS, AK-UCU710P, AK-UCU710PS**FCC NOTICE (USA)****Supplier's Declaration of Conformity**

Model Number: AK-UCU700P/AK-UCU700PS/AK-UCU710P/AK-UCU710PS

Trade Name: Panasonic

Responsible Party: Panasonic Corporation of North America

Two Riverfront Plaza, Newark, NJ 07102

Support contact: 1-800-524-1448

This device complies with part 15 of the FCC Rules.

Operation is subject to the following two conditions:

(1) This device may not cause harmful interference, and (2) this device must accept any interference received, including interference that may cause undesired operation.

FCC Note:

This equipment has been tested and found to comply with the limits for a class A digital device, pursuant to Part 15 of the FCC Rules. These limits are designed to provide reasonable protection against harmful interference when the equipment is operated in a commercial environment. This equipment generates, uses, and can radiate radio frequency energy, and if not installed and used in accordance with the instruction manual, may cause harmful interference to radio communications. Operation of this equipment in a residential area is likely to cause harmful interference in which case the user will be required to correct the interference at his own expense.

Warning:

To assure continued FCC emission limit compliance, the user must use only shielded interface cables when connecting to external units. Also, any unauthorized changes or modifications to this equipment could void the user's authority to operate it.

 indicates safety information.

For AK-UCU700E, AK-UCU700ES, AK-UCU710E, AK-UCU710ES

Caution for AC Mains Lead



FOR YOUR SAFETY PLEASE READ THE FOLLOWING TEXT CAREFULLY.

This product is equipped with 2 types of AC mains cable. One is for continental Europe, etc. and the other one is only for U.K.

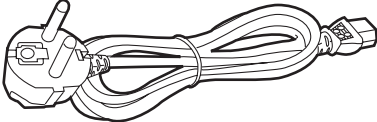
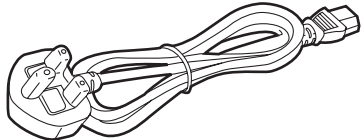
Appropriate mains cable must be used in each local area, since the other type of mains cable is not suitable.

<p>FOR CONTINENTAL EUROPE, ETC. Not to be used in the U.K.</p> 	<p>FOR U.K. ONLY If the plug supplied is not suitable for your socket outlet, it should be cut off and appropriate one fitted.</p> 
---	--

FOR U.K. ONLY

This appliance is supplied with a moulded three pin mains plug for your safety and convenience. A 13 amp fuse is fitted in this plug. Should the fuse need to be replaced please ensure that the replacement fuse has a rating of 13 amps and that it is approved by ASTA or BSI to BS1362. Check for the ASTA mark  or the BSI mark  on the body of the fuse.

If the plug contains a removable fuse cover you must ensure that it is refitted when the fuse is replaced. If you lose the fuse cover the plug must not be used until a replacement cover is obtained. A replacement fuse cover can be purchased from your local Panasonic Dealer.

How to replace the fuse

1. Open the fuse compartment with a screwdriver.

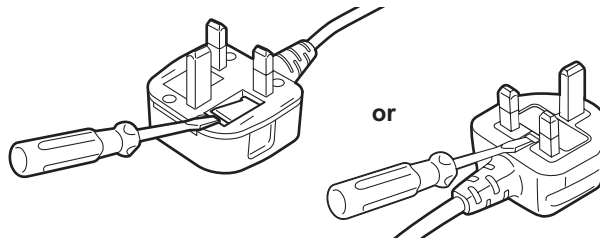

2. Replace the fuse.

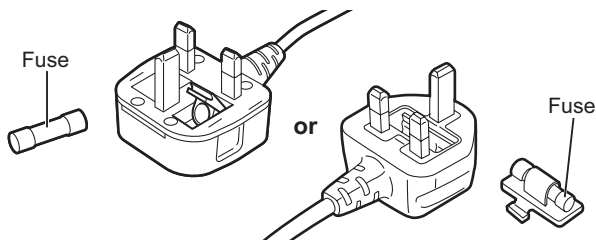

 indicates safety information.

EMC NOTICE FOR THE PURCHASER/USER OF THE APPARATUS

1. Pre-requisite conditions to achieving compliance with the above standards

<1> Peripheral equipment to be connected to the apparatus and special connecting cables

- The purchaser/user is urged to use only equipment which has been recommended by us as peripheral equipment to be connected to the apparatus.
- The purchaser/user is urged to use only the connecting cables described below.

<2> For the connecting cables, use shielded cables which suit the intended purpose of the apparatus.

- Video signal connecting cables
Use double-shielded coaxial cables, which are designed for 75-ohm type high-frequency applications, for SDI (Serial Digital Interface).
Coaxial cables, which are designed for 75-ohm type high-frequency applications, are recommended for analog video signals.
- Audio signal connecting cables
If your apparatus supports AES/EBU serial digital audio signals, use cables designed for AES/EBU.
Use shielded cables, which provide quality performance for high-frequency transmission applications, for analog audio signals.
- Other connecting cables (LAN, RS-422)
Use double shielded cables, which provide quality performance for high-frequency applications, as connecting cables.
- When connecting to the DVI signal terminal, use a cable with a ferrite core.
- If your apparatus is supplied with ferrite core(s), they must be attached on cable(s) following instructions in this manual.

2. Performance level

The performance level of the apparatus is equivalent to or better than the performance level required by these standards. However, the apparatus may be adversely affected by interference if it is being used in an EMC environment, such as an area where strong electromagnetic fields are generated (by the presence of signal transmission towers, cellular phones, etc.). In order to minimize the adverse effects of the interference on the apparatus in cases like this, it is recommended that the following steps be taken with the apparatus being affected and with its operating environment:

1. Place the apparatus at a distance from the source of the interference.
2. Change the direction of the apparatus.
3. Change the connection method used for the apparatus.
4. Connect the apparatus to another power outlet where the power is not shared by any other appliances.

AEEE Yönetmeliğine Uygundur.
AEEE Complies with Directive of Turkey.

Manufactured by:

Panasonic Connect Co., Ltd.
4-1-62 Minoshima, Hakata-ku, Fukuoka 812-8531, Japan

Importer:

Panasonic Connect Europe GmbH
Hagenauer Strasse 43, 65203 Wiesbaden, Germany

Authorized Representative in EU:

Panasonic Connect Europe GmbH
Panasonic Testing Centre
Winsbergring 15, 22525 Hamburg, Germany

Importer for UK:

Panasonic Connect UK,
a branch of Panasonic Connect Europe GmbH,
Maxis 2, Western Road, Bracknell, Berkshire, RG12 1RT

**Disposal of Old Equipment****Only for European Union and countries with recycling systems**

This symbol on the products, packaging, and/or accompanying documents means that used electrical and electronic products must not be mixed with general household waste.

For proper treatment, recovery and recycling of old products, please take them to applicable collection points in accordance with your national legislation.

By disposing of them correctly, you will help to save valuable resources and prevent any potential negative effects on human health and the environment.

For more information about collection and recycling, please contact your local authority, dealer or supplier.

Penalties may be applicable for incorrect disposal of this waste, in accordance with national legislation.

ІНФОРМАЦІЯ ПРО ПІДТВЕРДЖЕННЯ ВІДПОВІДНОСТІ ПРОДУКТУ

Виробник:	Panasonic Connect Co., Ltd.	Панасонік Коннект Ко., Лтд.
Адреса виробника:	Fukuoka, Japan	Фукуока Японія
Країна походження:	Japan	Японія

Імпортер:	ТОВ "ПАНАСОНІК УКРАЇНА ЛТД"
Адреса Імпортера:	вул. Васильківська, буд. 30, м. Київ, 03022, Україна

Примітки:

Термін служби виробу	7 років
----------------------	---------

Дату виготовлення можна визначити за комбінацією букв і цифр серійного номера, що розташований на маркувальній табличці виробу.

Приклад:

X X XXXXXXX

Рік: остання цифра року (6 – 2016, 7 – 2017, ... 0 – 2020)
Місяць: А – Січень, В – Лютий... L – Грудень

Table of Contents

Read this first!	2	INTERCOM2.....	59
Introduction	8	PGM.....	60
How to View This Manual	8	MoIP FORMAT.....	60
About trademarks and registered trademarks	8	NETWORK	61
About copyright.....	8	LAN.....	62
Illustrations and screen displays featured in the manual	8	TALLY IN SETTING	63
Overview.....	9	PTP SETTING	64
Notice.....	10	ST2110 SETTING.....	65
Personal computer requirements.....	10	SFP1(PRIMARY).....	66
Disclaimer of warranty	10	SFP1(PRIMARY)TX.....	67
Network security	11	SFP1(PRIMARY)RX.....	69
Memory cards	11	SFP2(SECONDARY).....	72
Accessories	12	SFP2(SECONDARY)TX.....	73
Precautions for Use	13	SFP2(SECONDARY)RX.....	75
Precautions for Installation	14	NMOS SETTING	78
Mounting the unit in a rack.....	15	NDI/SRT SETTING.....	79
Parts and their functions	16	DNS SETTING.....	80
Front panel 1.....	16	MAINTENANCE	81
Front panel 2.....	17	START UP.....	82
Rear panel 1	18	SETUP	82
Rear panel 2	19	ND/CC NAME	84
Rear panel 3 (with AK-NP701/AK-NP702/ AK-NP703 option).....	20	CCU VERSION	85
Picture monitor (PM)	21	OPTION VERSION.....	85
Picture monitor displays.....	21	PM VIEW SETTING.....	86
Transition of displays	22	PM OPERATION STATUS.....	87
Information display.....	23	SYSTEM.....	88
Warning displays.....	23	SD CARD.....	90
IRIS display.....	24	Saving and loading reference files and scene files.....	91
Status displays.....	25	Web Screen	92
Operation displays	32	Network settings.....	92
Auto displays	33	Software.....	92
LCD panel	34	Using EasyIP Setup Tool Plus to set the unit's settings	92
Buttons on the LCD panel	35	Displaying the web screen.....	94
About entering characters.....	38	Notice regarding the Web screen	94
CCU menu	39	Displaying the web screen using a personal computer	94
Menu operations.....	39	Logging into the web screen.....	97
Displaying and hiding the menus.....	40	Web setting screen	97
Basic menu operations	41	Product information screen [PRODUCT INFO.].....	98
Operation with menu items that have multiple setting items on one line	43	View system settings screen [SYSTEM MODE].....	100
Text input	44	Network settings screen [NETWORK].....	104
CCU MENU	45	ROP account settings screen [ROP ACCOUNT SETTING].....	126
OPERATION.....	46	User management screen [USER MNG.].....	127
SYSTEM MODE	47	Troubleshooting	128
OUTPUT FORMAT	49	Operation.....	128
SETTING	51	Web Screen	130
HD PHASE	52	Reference	131
BAR ID.....	53	Connector pin assignment table	131
SOURCE SETTING.....	54	Front panel.....	131
AUDIO	55	Rear panel	131
MIC OUT.....	55	Front panel G/L indicator specifications.....	136
CCU INTERCOM TALK.....	56	Appearance	137
CCU INTERCOM RECEIVE.....	56	Specifications	138
COMMUNICATION	57	Index	140
INTERCOM1.....	58		

Introduction

How to View This Manual

About trademarks and registered trademarks

- Microsoft®, Windows®, Windows® 10, Windows® 11, Microsoft Edge, ActiveX® and DirectX® are either registered trademarks or trademarks of Microsoft Corporation in the United States and other countries.
- Apple, Mac, OS X, macOS and Safari are registered trademarks of Apple Inc., in the United States and other countries.
- Intel® and Intel® Core™ are trademarks or registered trademarks of Intel Corporation and its subsidiaries in the United States and other countries.
- SDXC logo is a trademark of SD-3C and LLC.
- Dante® is a registered trademark of Audinate Pty Ltd.
- NDI® is a registered trademark of NewTek, Inc. in the United States and other countries.
- Other names of companies or products in this manual are either registered trademarks or trademarks of their respective owners.

About copyright

Distributing, copying, disassembling, reverse compiling, reverse engineering and also exporting in violation of export laws of the software provided with this unit are expressly prohibited.

Illustrations and screen displays featured in the manual

- What is shown in the manual's illustrations and screen displays may differ from how it actually appears.
- The screenshots are used in accordance with the guidelines of Microsoft Corporation.
- Functions which can be used by Windows only are indicated using [Windows].

Overview

This camera control unit (CCU) is designed to be used with the 4K studio camera (AK-UC4000; sold separately, AK-UC3300; sold separately, AK-PLV100; sold separately).

Connect it to the 4K studio camera (hereinafter referred to as the camera) with an optical fiber multi cable (sold separately).

Compatible with multiple formats and capable of simultaneous output of UHD/HD, HDR/SDR, BT.2020/BT.709, and high-speed/1x-speed.

Along with a number of camera outputs and return inputs, the unit is also equipped with independent TRUNK input and output.

The front panel is equipped with a color LCD touch control screen to improve operability and information accessibility.

There are dedicated ROP and MSU connectors to provide interfaces for both a remote operation panel and a master setup unit, and connection via LAN is also possible.

The following options are available to make operation over IP possible with this unit:

- AK-NP701: SMPTE ST2110 functionality
- AK-NP702: Dante audio functionality
- AK-NP703: STREAM (High band NDI and SRT) functionality

Notice

Personal computer requirements

Use a host computer that satisfies the following conditions.

CPU	CPU Intel® Core™2 DUO 2.4 GHz or better is recommended
Memory	<ul style="list-style-type: none"> • Windows Microsoft® Windows® 10 Pro 32-bit: 1 GB or more Microsoft® Windows® 10 Pro 64-bit: 2 GB or more Microsoft® Windows® 11 Pro: 4 GB or more
	<ul style="list-style-type: none"> • Mac 2 GB or more
Network function	100BASE-TX 1 port
Image display function	Resolution: 1024×768 pixels or more Color generation: True Color 24-bit or better
Supported operating systems and Web browser	<ul style="list-style-type: none"> • Windows <ul style="list-style-type: none"> • Microsoft® Windows® 10 Pro 64-bit/32-bit Microsoft Edge • Microsoft® Windows® 11 Pro Microsoft Edge
	<ul style="list-style-type: none"> • Mac <ul style="list-style-type: none"> • OS X 10.12 Safari 10

Disclaimer of warranty

IN NO EVENT SHALL Panasonic Connect Co., Ltd. BE LIABLE TO ANY PARTY OR ANY PERSON, EXCEPT FOR REPLACEMENT OR REASONABLE MAINTENANCE OF THE PRODUCT, FOR THE CASES, INCLUDING BUT NOT LIMITED TO BELOW:

- ANY DAMAGE AND LOSS, INCLUDING WITHOUT LIMITATION, DIRECT OR INDIRECT, SPECIAL, CONSEQUENTIAL OR EXEMPLARY, ARISING OUT OF OR RELATING TO THE PRODUCT;
- PERSONAL INJURY OR ANY DAMAGE CAUSED BY INAPPROPRIATE USE OR NEGLIGENT OPERATION OF THE USER;
- UNAUTHORIZED DISASSEMBLE, REPAIR OR MODIFICATION OF THE PRODUCT BY THE USER;
- INCONVENIENCE OR ANY LOSS ARISING WHEN IMAGES ARE NOT DISPLAYED, DUE TO ANY REASON OR CAUSE INCLUDING ANY FAILURE OR PROBLEM OF THE PRODUCT;
- ANY PROBLEM, CONSEQUENTIAL INCONVENIENCE, OR LOSS OR DAMAGE, ARISING OUT OF THE SYSTEM COMBINED BY THE DEVICES OF THIRD PARTY;
- ANY INCONVENIENCE, DAMAGES OR LOSSES RESULTING FROM ACCIDENTS CAUSED BY AN INADEQUATE INSTALLATION METHOD OR ANY FACTORS OTHER THAN A DEFECT IN THE PRODUCT ITSELF;
- LOSS OF REGISTERED DATA CAUSED BY ANY FAILURE;
- ANY DAMAGE OR CLAIMS DUE TO LOSS OR LEAKAGE OF IMAGE DATA OR SETTING DATA SAVED ON THIS UNIT OR ON A MEMORY CARD OR PERSONAL COMPUTER.

Network security

This unit also has functions which are used when it is connected to a network.

Using the unit when it is connected to a network may possibly give rise to the following.

- Leakage or disclosure of information transmitted via this unit
- Unauthorized use of this unit by a third person with malicious intent
- Interference or stoppage of this unit by a third person with malicious intent

It is your responsibility to take sufficient network security measures such as those described below to protect yourself against the above risks.

- Use this unit in a network secured by a firewall, etc.
- If this unit is used in a system with a personal computer connected, make sure that checks for and removal of computer viruses and malicious programs are implemented regularly.

Also observe the following points.

- Do not install the unit in a location where the unit, cables, and other parts may be easily damaged.

Memory cards

Memory cards used with the unit should conform to SD, SDHC or SDXC standards.

Be sure to use the unit to format memory cards.

Memory cards with the following capacity can be used with the unit.

SD:	2 GB
SDHC:	4 GB to 32 GB
SDXC:	64 GB

For the latest information not included in these Operating Instructions, refer to the support pages at the following website.



<https://pro-av.panasonic.net/en/>

Observe the following points when using and storing this unit.

- Avoid high temperature and humidity.
- Avoid water droplets.
- Avoid static electricity.

Accessories

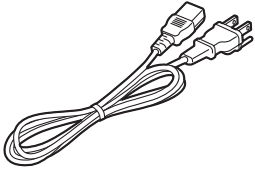
- After removing the product from its container, dispose of the power cable cap (if supplied) and packing materials in an appropriate manner.

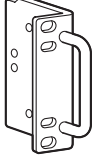
<p>Power cable</p> <ul style="list-style-type: none">• for AK-UCU700P, AK-UCU700PS, AK-UCU710P, AK-UCU710PS.....1  <ul style="list-style-type: none">• for AK-UCU700E, AK-UCU700ES, AK-UCU710E, AK-UCU710ES.....2 	<p>Rack mount adapters*1.....2</p> <p>➔ "Mounting the rack mount adapters" (see page 15)</p> 
--	--

*1: The screws for the rack mount adapters come attached to the unit.

Precautions for Use

In addition to the safety precautions given in "Read this first!", also observe the following instructions.

■ Handle carefully

- Do not drop the product or subject it to a strong impact. Doing so may cause a failure or accident.

■ Avoid using the unit outdoors

- Use the product in an ambient temperature of 0 °C to 40 °C (32 °F to 104 °F). Avoid using the product in a cold place where the temperature drops below 0 °C (32 °F) or in a hot place where the temperature rises above 40 °C (104 °F) because an extremely low or high temperature will adversely affect the internal parts.

■ Turn off the power before connecting or disconnecting cables

- Before connecting or disconnecting the cables, be sure to turn the power off.

■ Avoid humidity and dust

- Avoid using the product in a very humid or dusty place because a lot of humidity and dust will cause damage to the internal parts.

■ Cleaning

- Turn the power off and wipe the product with a dry cloth.
- To remove stubborn dirt, dip a cloth into a diluted solution of kitchen detergent (neutral detergent), wring it out well, and wipe the product gently. Then, wipe the product with a cloth dampened with water. Finally, wipe the product with a dry cloth.



NOTE

- Avoid using benzene, paint thinners and other volatile fluids.
- If a chemical cleaning cloth is to be used, carefully read through the precautions for its use.

■ Optical fiber multi cable

- When the optical fiber connectors of the optical fiber multi cable (sold separately) become dirty, the optical signal transmission state will deteriorate. Use commercially available optical connector cleaner to clean the optical connector end faces in accordance with the instructions.

■ LAN cable

- Use a category 5e or better STP (Shielded Twisted Pair) LAN cable.

■ Consumable parts

- The cooling fan is a consumable part. The replacement cycle is approximately 10 years (when used approximately 8 hours per day).
Contact your dealer to request cooling fan replacement.

■ Disposal of the unit

- When the unit has reached the end of its service life and is to be disposed of, ask a qualified contractor to dispose of the unit properly in order to protect the environment.

■ Information on software used with this product

This product includes GNU General Public License (GPL) and GNU Lesser General Public License (LGPL) licensed software, and the customer is entitled to obtain, modify, or redistribute the source code for the software.

- This product includes MIT Licensed software.
- This product includes BSD Licensed software.
- For details on obtaining the source codes, visit the following website.
<https://pro-av.panasonic.net/en/>
However, do not contact Panasonic for questions regarding obtained source codes.

■ JPEG XS patent pool licensing

This product or service includes JPEG XS compliant features that are covered by patents in the United States and in other jurisdictions owned by intoPIX SA ("intoPIX") and/or Fraunhofer-Gesellschaft zur Foerderung der angewandten Forschung E.V. ("Fraunhofer") and listed at www.jpegxspool.com. Additional patents may be pending in United States and elsewhere.

Precautions for Installation

In addition to the safety precautions given in "Read this first!", also observe the following instructions.

Be sure to ask your dealer to perform the installation and connection work for the unit.

■ Connecting a power supply

- Be sure to use the power cable supplied with the unit.
- Connect the [SIGNAL GND] terminal on the rear of the unit to the system ground.
- When the unit will not be used for a long time, turn off the [POWER] switch and remove the power plug from the outlet to save power.

■ Ground of the power plug

- The power cable supplied with the unit has a 3-prong plug with a ground terminal. Connect it to a 3-prong outlet with a ground contact.

■ Grounding

- Ground the system via the [SIGNAL GND] terminal on the unit.

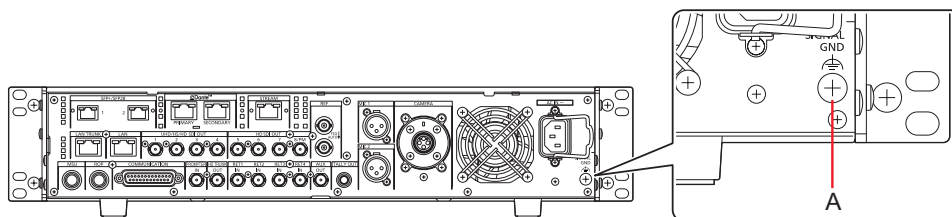

A. [SIGNAL GND] terminal

■ Handle carefully

- Dropping the unit or subjecting it to a strong impact or vibration may cause a failure or accident.
- Do not allow any foreign objects to enter inside the unit.
Allowing water, metal items, food or drink, or other foreign objects to enter inside the unit may cause a fire or electric shock.

■ Installation location

- This unit is designed for indoor use only.
- Do not install the unit in a cold place where the temperature drops below 0 °C (32 °F) or in a hot place where the temperature rises above 40 °C (104 °F).
- Avoid installing the unit where it will be exposed to direct sunlight or near an outlet from which hot air is blown out.
- Installing the unit in a location with a lot of humidity, dust, or vibration may result in a failure.

Mounting the unit in a rack

Mounting the rack mount adapters

1. **Remove the setting legs (A) secured to the unit.**
Remove them using a Phillips screwdriver.
2. **Mount the supplied rack mount adapters (B).**
 - Mounting screws are not supplied. Use mounting screws removed from the unit using a Phillips screwdriver.
 - Tighten the mounting screws for rack mount adapters using a torque of 110 N·m or more.

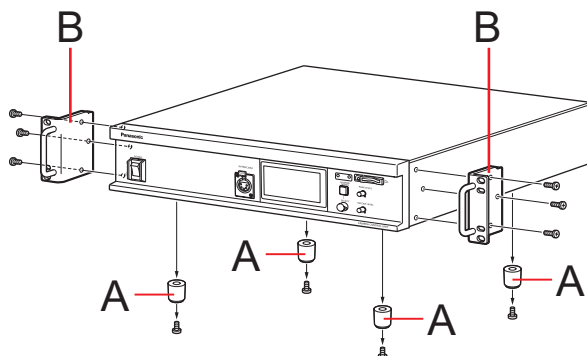

A. Setting legs

B. Rack mount adapters

Mounting the unit in a rack

- Use the unit securely mounted in a standard 19-type rack (depth: 600 mm [23-5/8 inches] or more) compliant with EIA or JIS standards or equivalent.
- Securely fix the unit in place using screws that are appropriate for the rack.
- Be sure to attach a support guide for supporting (A) the rear of the unit. (Provide a support guide that is appropriate for the rack.)

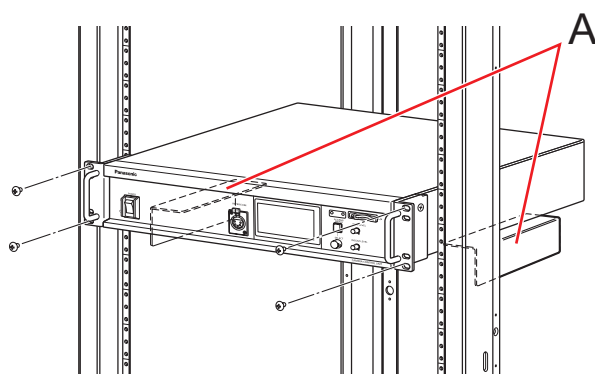

A. Support guide

Mounting positions

In the case of the EIA standard rack	In the case of the JIS standard rack
<p>76.2 mm (3 inches)</p>	<p>50 mm (1-31/32 inches)</p>

NOTE

- Do not block the ventilation holes when installing the unit.

Parts and their functions

Front panel 1

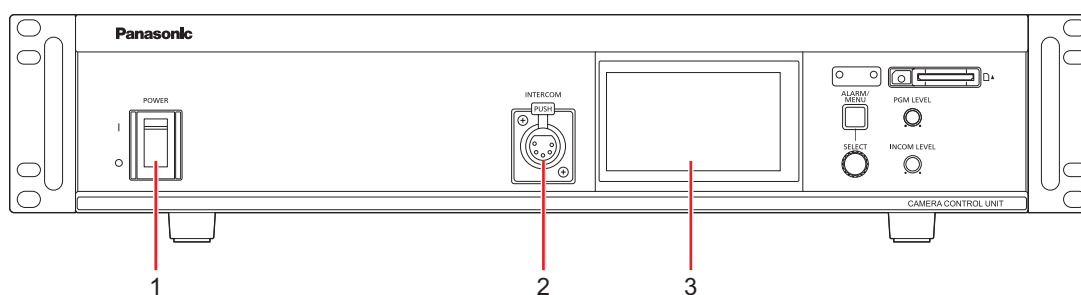

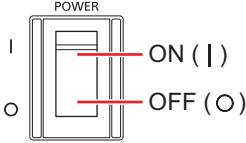
1	[POWER] switch	<p>This is the unit's power switch. Move it to the ON position to turn on the power.</p> 
2	[INTERCOM] connector	<p>This connector is for connecting the intercom. This connector enables calls with the intercom line of the camera. Calls can also be made with the camera when the camera's power is OFF.</p>
3	LCD panel	<p>Displays the LCD display screen, or displays the SDI images output from the [HD SDI OUT8/PM] connector.</p>

Front panel 2

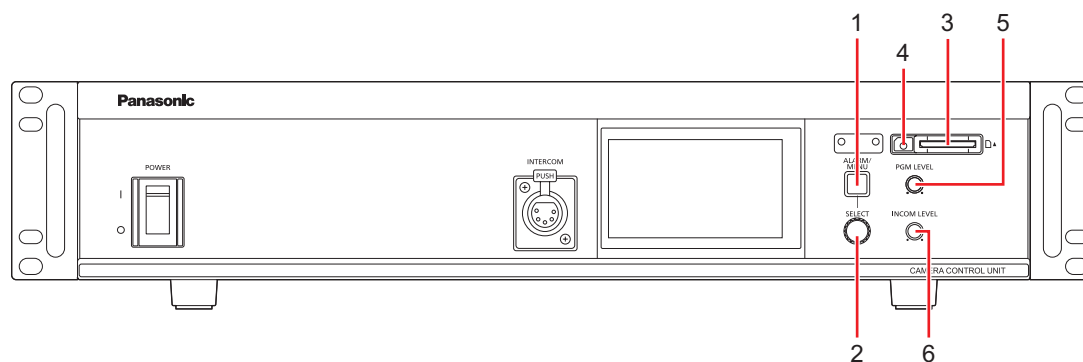

1	[MENU] button/ [ALARM] lamp	When you press the [MENU] button, the menu is displayed on the SDI output that is output from the [HD SDI OUT8/PM] connector. The menu display ends when you press it again. When you hold down the [MENU] button, the same images that are displayed on the SDI output that is output from the [HD SDI OUT8/PM] connector are also displayed on the LCD panel. Hold down again to return to the LCD display screen. This also acts as an [ALARM] lamp that lights red when a problem occurs with the unit. ➔ "Menu operations" (see page 39)
2	[SELECT] dial	This jog dial is for menu screen operations. When the [SELECT] dial is turned clockwise, the cursor moves down; conversely, when it is turned counterclockwise, the cursor moves up. Press the [SELECT] dial to select the menu items. ➔ "Menu operations" (see page 39)
3	Memory card slot	Insert a memory card (sold separately). A memory card can be used to set this unit. ➔ "SD CARD" (see page 90)
4	Memory card access lamp	This is lit while the memory card is being accessed.
5	[PGM LEVEL] adjustment dial	This dial adjusts the volume level of the intercom's program audio mix.
6	[INCOM LEVEL] adjustment dial	This dial adjusts the volume level of the sound heard through the intercom.

Rear panel 1

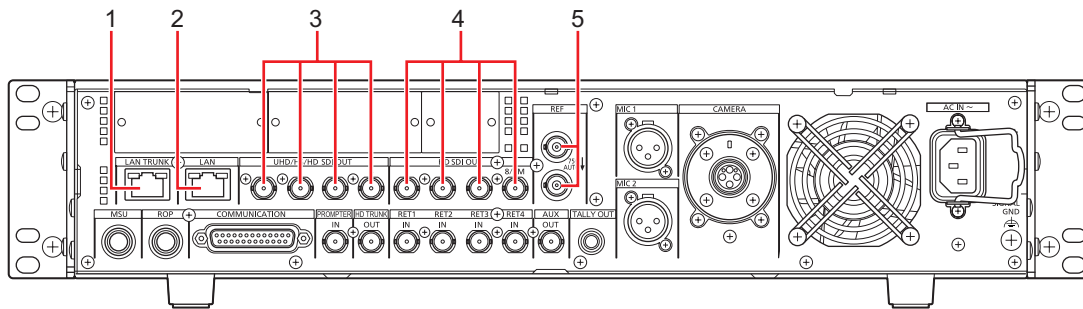

1	[LAN TRUNK] connector	LAN communication is carried using optical transmission between the camera and CCU.
2	[LAN] connector	It is the LAN connector (RJ45) for connecting the ROP (AK-HRP1010 / AK-HRP1015) with an IP connection. Use a switch hub and connect the devices with a 10BASE-T/100BASE-TX straight cable. This connector is for connecting a personal computer when configuring Web settings. ➔ "Web Screen" (see page 92)
3	[UHD/HS/HD SDI OUT(1 to 4)] connectors	UHD (connects to the AK-UC4000 / AK-UC3300 / AK-PLV100), HS and 3G-HD, HD video signal output connectors (BNC). Signals output can be selected from the CCU menu. ➔ "OUTPUT FORMAT" (see page 49)
4	[HD SDI OUT(5 to 7, 8/PM)] connectors	These connectors (BNC) are for outputting SDI signals in HDTV format. The 3G-HD/HD output mode can be selected by setting the CCU menu. SDI output from the [HD SDI OUT8/PM] connector can be switched to main line image output or picture monitor output via the CCU menu configurations or ROP control. ➔ "OUTPUT FORMAT" (see page 49)
5	[REF] connectors	These connectors (BNC) are for inputting reference signals. Black burst (BB) signals and tri-level sync signals can be input, and the type of signals input is recognized automatically. When no cable is connected to the loop-through output connector (B), the connector is automatically terminated at 75 Ω. Connecting a cable to this connector releases 75 Ω termination. When a cable is connected to the loop-through output connector (B), be sure to connect the other end of the cable to a connector. <div style="text-align: center;"> </div> <p>A. Reference signal input connector B. Loop-through output</p>

Rear panel 2

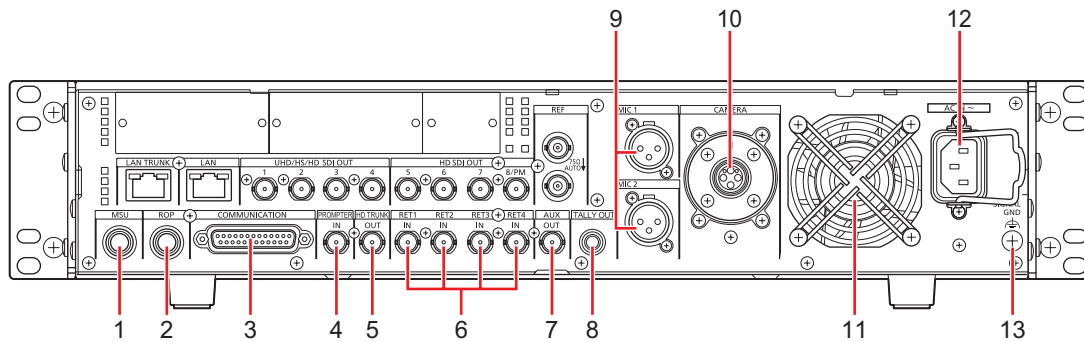

1	[MSU] connector	This connector is for connecting an MSU (sold separately).
2	[ROP] connector	This connector is for connecting a ROP (sold separately).
3	[COMMUNICATION] connector	This connector is for connecting the intercom signals and tally signals to the external system.
4	[PROMPTER IN] connector	This connector (BNC) is for inputting HD-SDI prompter signals.
5	[HD TRUNK OUT] connector	This connector outputs the HD SDI TRUNK signal input to the camera.
6	[RET1 IN] to [RET4 IN] connectors	These connectors (BNC) are for inputting SDI signals for return images in HDTV formats. 3G, HD-SDI signals are detected automatically.
7	[AUX OUT] connector	It is possible to select the RET1 to RET4 inputs, ST2110 (RETURN) input, or STREAM input for output through this connector.
8	[TALLY OUT] connector	This connector controls the tally output (R, G) and alarm output.
9	[MIC1] and [MIC2] connectors	These connectors are for outputting the analog signals of microphones 1 and 2 of the camera. The microphone level is 0 dBm/600 Ω.
10	[CAMERA] connector	This connector is for connecting the optical fiber multi cable (sold separately).
11	Cooling fan	This is the unit's cooling fan.
12	AC power socket	This socket is for inputting AC power. Connect the supplied power cable, and use a 3-prong outlet and ground the unit properly.
13	[SIGNAL GND] terminal	Connect this to the system ground.

Rear panel 3 (with AK-NP701/AK-NP702/AK-NP703 option)

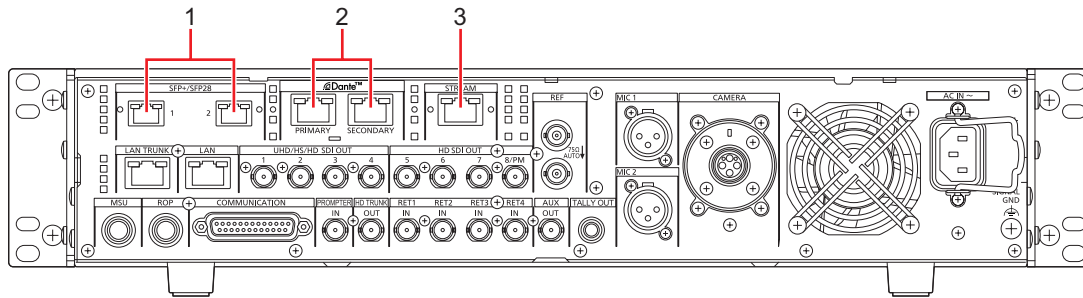

1	[SFP+/SFP28(1, 2)] slots	These slots are for the ST2110 input/output transceiver.
2	[Dante(PRIMARY, SECONDARY)] connectors	These are the LAN connectors for Dante audio input/output.
3	[STREAM] connector	This is the LAN connector for NDI and SRT input/output.

Picture monitor (PM)

Picture monitor displays

Display the camera statuses, warnings, and other information on the picture monitor using the operation panel of the ROP.

Press the [CHARA] button (A) of the ROP to display the desired information.

The camera statuses, warnings, and other information are cleared when the [CHARA] button of the ROP is held down.

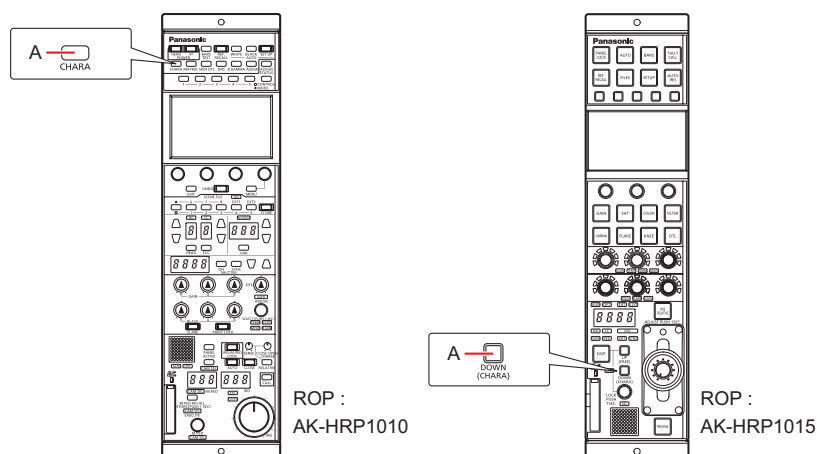

A. [CHARA] button

NOTE

- These can also be viewed on the LCD panel.

Transition of displays

When trouble is detected, warning information is automatically displayed on the picture monitor.

Even if status information or operation information is already displayed on the picture monitor when trouble is detected, priority is given to the display of the warning information.

The descending sequence of priority for the displays on the picture monitor is as follows: warning displays → auto displays → status displays → ROP menu displays → CCU menu displays → operation displays → no display.

When the warning information with the highest priority disappears, the warning information with the next highest priority appears.

Priority	Screen	ROP connected	
		Yes	No
High ↑ ↓ Low	Warning displays	Warnings are automatically displayed when trouble is detected. <ul style="list-style-type: none"> • Self-recovery • The warning displays are cleared • Press the [CHARA] button of the ROP No display→(WARNING)→ IRIS →Status displays→ Status1 → Status2 → Status3 → Status4 → Status5 → Status6 → IRIS . . . • Hold down the [CHARA] button of the ROP The warning displays are cleared 	Warnings are automatically displayed when trouble is detected. <ul style="list-style-type: none"> • Self-recovery • The warning displays are cleared • Touch a USER button of this unit (Enabled when [CHARA] is assigned to a USER button on the LCD panel.) <ul style="list-style-type: none"> • When the transition source screen is displayed: The display switches to the transition source screen. • When the transition source screen is not displayed: The warning displays are cleared
	Auto displays	Automatically displayed	Automatically displayed
	Status displays	<ul style="list-style-type: none"> • Perform display operations using the [CHARA] button of the ROP. • Press the [CHARA] button of the ROP No display→(WARNING)→ IRIS →Status displays→ Status1 → Status2 → Status3 → Status4 → Status5 → Status6 → IRIS . . . • Hold down the [CHARA] button of the ROP The status displays end. 	–
	CCU menu displays	Display by pressing the [MENU] button on the unit. <ul style="list-style-type: none"> • Operations using the [SELECT] dial on the unit 	Display by pressing the [MENU] button on the unit. <ul style="list-style-type: none"> • Operations using the [SELECT] dial on the unit
	Operation displays	Automatically displayed	Automatically displayed
	No display	–	–

Information display

This information is displayed on the picture monitor (PM).

Warning displays

The warning information is displayed when trouble is detected in the unit, camera, or optical fiber multi cable.



- Warning information displayed is cleared when the status returns to normal.
- To manually clear the warning information display, hold down the [CHARA] button of the ROP.

Information displayed

Display item	Description
CAM RCV LVL NG	The level of the optical signal received by the camera is low
CCU RCV LVL NG	The level of the optical signal received by the CCU is low
CAM FAN NG	Trouble with the cooling fan of the camera
CCU FAN NG	Trouble with the cooling fan of the CCU
CAM HIGH TEMP	The temperature of the camera is abnormally high
CCU HIGH TEMP	The temperature of the CCU is abnormally high If you continue operation even with the message displayed, power supply to the camera may stop as a protective measure.
CABLE OPEN	The optical fiber multi cable is not connected
CABLE SHORT	<ul style="list-style-type: none"> • The optical fiber multi cable is shorted • The power supply voltage to the unit dropped momentarily Power supply to the camera will stop as a protective measure. Turn the unit off immediately, and determine and resolve the problem before turning it back on. • The camera is malfunctioning or startup of the camera failed for reasons other than the above.
FORMAT NG	FORMAT of the CAM mode and the CCU mode does not match
Saving Data. Do not turn off power until complete.	Saving the data from the ROP
Loading Data. Do not turn off power until complete.	Loading the data from the ROP
CAM WARM-UP	The camera is warming up
TURN POWER OF (READ FACTORY)	The Factory settings of the camera are being read
ST2110 DEV ERROR	A problem has occurred with the ST2110 option board (when AK-NP701 is attached)
DANTE DEV ERROR	Some kind of problem has occurred with the Dante option board, the external Dante device, or the Dante network (when AK-NP702 is attached)
NDI/SRT DEV ERROR	A problem has occurred with the Streaming option board (when AK-NP703 is attached)

IRIS display

When the information is not displayed on the picture monitor, display it by pressing the [CHARA] button of the ROP.

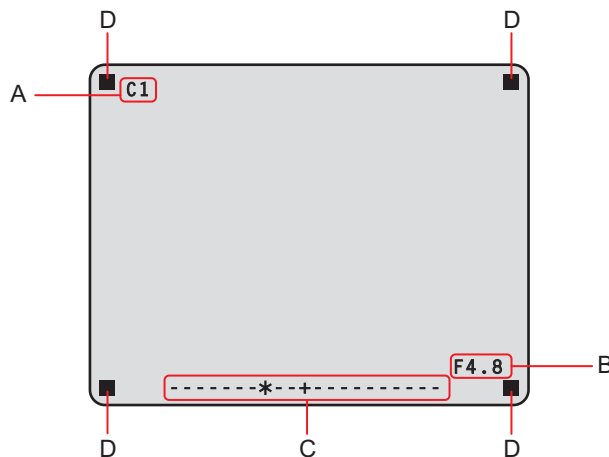

- A. Camera number
- B. IRIS F value
- C. IRIS level
- D. TALLY INFO

- Set each item to be displayed on the [PM VIEW SETTING] screen that can be accessed by selecting [MAINTENANCE] on the CCU menu. However, this screen will not appear if the menu's [IRIS LEVEL] setting is [OFF].
- The IRIS schedule is displayed as follows depending on the setting of [IRIS SCALE] that can be accessed by selecting [MAINTENANCE] > [SETUP].

IRIS SCALE: FULL



IRIS SCALE: 2STOP

- In the IRIS level display, the IRIS F value stored in IRIS memory is indicated at the center (+), and the current IRIS F value is displayed relative to the center as "*".
When the center value (+) and the current IRIS value (*) overlap, the display shows "> * <".



- When the IRIS level falls outside either end of the display range, the status is displayed as a flashing ">" or "<".



- TALLY INFO (D)
 - Display the R tally in two segments of the upper row and the R, G, or YL tally in two segments of the lower row.
 - When all R, G, and YL tally signals are ON, the upper row is red, and the left and right segments of the lower row are green and yellow, respectively.
 - When the R and G tally signals are ON, the upper row is red and the lower row is green.

Status displays

From the IRIS display screen, press the [CHARA] button of the ROP to display the "status display screen".

However, when the "IRIS LEVEL" setting is "OFF", the screen will be displayed first if the [CHARA] button of the ROP is pressed when the information is not displayed on the picture monitor.

When the "status display screen" appears, pressing the [CHARA] button of the ROP again displays the status screen.

Pressing the [CHARA] button repeatedly switches display through the status screens in the sequence 1/6 → 2/6 → 3/6 → 4/6 → 5/6 → 6/6 → 1/6

Status display screen

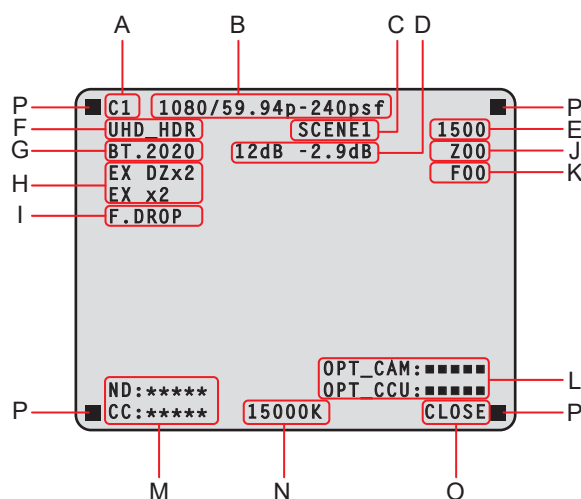

A. Camera number

B. System format

C. Scene file number

Not displayed when SCENE FILE is set to OFF.

D. M.GAIN value/M.GAIN VAR value

E. Shutter value

F. CCU format information

G. COLORIMETRY (Y/C conversion coefficient) information

H. Extender information

I. Lens information

J. Zoom position

K. Focus position

L. Optical signal reception status (camera and CCU)

M. ND/CC filter value

The CC filter value is not displayed when AK-UC3300 and AK-PLV100 are connected.

N. Color temperature

O. IRIS F value

P. TALLY INFO

- Set each item to be displayed on the [PM VIEW SETTING] screen that can be accessed by selecting [MAINTENANCE] on the CCU menu.
- The camera format indicates the format of the signal output from the camera.
- Pressing the [CHARA] button of the ROP from the status display screen displays the "status screen".
- TALLY INFO (L)
 - Display the R tally in two segments of the upper row and the R, G, or YL tally in two segments of the lower row.
 - When all R, G, and YL tally signals are ON, the upper row is red, and the left and right segments of the lower row are green and yellow, respectively.
 - When the R and G tally signals are ON, the upper row is red and the lower row is green.

Status displays (page 1 of 6)

```

1/6  -Status1-
HLG MODE          VAR
SDR MODE          VAR

HLG B.GAMMA      ON
HLG KNEE         ON

SDR CONV GAIN    0
SDR CONV POINT   0
SDR CONV SLOPE   0

```

Item	Display range	Remarks
HLG MODE	Setting values on camera	The HLG mode is displayed here.
SDR MODE	Setting values on camera	The SDR mode is displayed here.
HLG B.GAMMA	Setting values on camera	The status of black gamma when HLG is enabled is displayed here.
HLG KNEE	Setting values on camera	The status of knee when HLG is enabled is displayed here.
SDR CONV GAIN	Setting values on camera	The gain value when HDR video is converted to SDR video is displayed here.
SDR CONV POINT	Setting values on camera	The video level to start compression for SDR video is displayed here.
SDR CONV SLOPE	Setting values on camera	The slope to compress video signals is displayed here.

Status displays (page 2 of 6)

```

2/6  -Status2-
CAM No.           1
CAM FAN MODE     NORMAL
BLACK SHADING    OFF
WHITE SHADING    OFF
FLARE            OFF
GAMMA            OFF
BLACK GAMMA      OFF
KNEE             OFF
WHITE CLIP       OFF
DRS SW           OFF
MATRIX           OFF
SHUTTER          OFF

```

Item	Display range	Remarks
CAM No.	1 to 99	The camera number is displayed here.
CAM FAN MODE	Setting values on camera	Indicates the operational mode of the camera fan.
BLACK SHADING	Setting values on camera	The status of the black shading is displayed here.
WHITE SHADING	Setting values on camera	The status of the white shading is displayed here.
FLARE	Setting values on camera	The status of the FLARE is displayed here.
GAMMA	Setting values on camera	The status of the gamma correction is displayed here.
BLACK GAMMA	Setting values on camera	The status of the black gamma is displayed here. <ul style="list-style-type: none"> This function changes the amplification rate of the video signals in the low-brightness areas.
KNEE	Setting values on camera	The status of the knee function is displayed here. <ul style="list-style-type: none"> This function attenuates that part of the video signal that exceeds the prescribed level (knee point) to minimize saturation.
WHITE CLIP	Setting values on camera	The status of the white clip function is displayed here.
DRS SW	Setting values on camera	The status of the DRS SW is displayed here.
MATRIX	Setting values on camera	The status of the matrix function is displayed here. <ul style="list-style-type: none"> This function compensates the saturation and hue.
SHUTTER	Setting values on camera	The speed of the electronic shutter is displayed here. <ul style="list-style-type: none"> For the setting values, refer to the Operating Instructions for the camera.

Status displays (page 3 of 6)

```

3/6  -Status3-
GAMMA MODE          HD
M.GAIN              36dB
M.GAIN VAR          -2.9dB
UHD DETAIL          OFF
UHD SKIN TONE DETAIL OFF
HD DETAIL           OFF
HD SKIN TONE DETAIL OFF
ND FILTER           ****
CC FILTER           ****
LENS EXTENDER       1.0
AUTO IRIS           OFF
SCENE FILE          1

```

Item	Display range	Remarks
GAMMA MODE	Setting values on camera	The selected gamma type is displayed here.
M.GAIN	Setting values on camera	The gain increase value is displayed here.
M.GAIN VAR	Setting values on camera	The gain offset value is displayed here.
UHD DETAIL	Setting values on camera	The status of the UHD DETAIL is displayed here.
UHD SKIN TONE DETAIL	Setting values on camera	Indicates the status of the SKIN TONE DETAIL function. <ul style="list-style-type: none"> This function minimizes the detail components applied to skin tone.
HD DETAIL	Setting values on camera	The status of the HD DETAIL is displayed here.
HD SKIN TONE DETAIL	Setting values on camera	Indicates the status of the SKIN TONE DETAIL function. <ul style="list-style-type: none"> This function minimizes the detail components applied to skin tone.
ND FILTER	Setting values on camera	The names of the ND filters are displayed here. <ul style="list-style-type: none"> Indicates the names (4 letters each) corresponding to ND filters 1 to 5. The names configured in the CCU screen appear. This will be ND filters 1 to 4 when AK-UC3300 and AK-PLV100 are connected.
CC FILTER	Setting values on camera	The names of the CC filters are displayed here. <ul style="list-style-type: none"> Indicates the names (5 letters each) corresponding to CC filters A to E. The names configured in the CCU screen appear. This is not displayed when AK-UC3300 and AK-PLV100 are connected.
LENS EXTENDER	1.0 2.0	The magnification of the lens extender is displayed here.
AUTO IRIS	OFF ON	The status of the auto IRIS function is displayed here.
SCENE FILE	OFF --- 1 to 8	The selected scene file is displayed here.

Status displays (page 4 of 6)

4/6 -Status4-	
ASU REF	FACTORY
ASU MODE	OUT FULL
RETURN1	RET1
RETURN2	RET2
RETURN3	RET3
RETURN4	RET4

Item	Display range	Remarks
ASU REF	FACTORY USER1 USER2 USER3 REF1 REF2 REF3	The reference file used during auto setup is displayed here. <ul style="list-style-type: none"> This is not displayed when AK-PLV100 is connected.
ASU MODE	OUT FULL OUT EASY	The auto setup mode is displayed here. <ul style="list-style-type: none"> This is not displayed when AK-PLV100 is connected.
RETURN1	RET1	The statuses of the input format allocations for SDI return signals 1 to 4 are displayed here.
RETURN2	RET2	
RETURN3	RET3	
RETURN4	RET4	

Status displays (page 5 of 6)

```

5/6  -Status5-
SDI OUTPUT1-4      12G
SDI OUTPUT5-6      HD
HDR SELECT          SDR
SDI OUTPUT7         HD
HDR SELECT          SDR
SDI OUTPUT8         HD
HDR SELECT          SDR

```

Item	Display range	Remarks
SDI OUTPUT1-4	12G 3Gx4(2SI) 6G 3G(Level A) HD TrueP PsF Over3G	Output formats of SDI OUT1 through SDI OUT4 are displayed here.
SDI OUTPUT5-6	3G(Level A) HD TrueP PsF Over3G	Output formats of SDI OUT5 through SDI OUT6 are displayed here.
HDR SELECT	SDR HDR	Displays HDR or SDR according to the FORMAT of SDI OUT5 to SDI OUT6.
SDI OUTPUT7	3G(Level A) HD TrueP PsF Over3G	Output format of SDI OUT7 is displayed here.
HDR SELECT	SDR HDR	Displays HDR or SDR according to the FORMAT of SDI OUT7.
SDI OUTPUT8	HD TrueP PsF Over1.5G	Output format of SDI OUT8 is displayed here.
HDR SELECT	SDR HDR	Displays HDR or SDR according to the FORMAT of SDI OUT8.

Status displays (page 6 of 6)

```

6/6  -Status6-

BUTTON ASSIGN
  USER1          CHARA
  USER2          MENU/USER1 LOCK
HOURS CCU        *****H
CABLE OPEN
CABLE SHORT
CAM RECEIVE LEVEL    ■■■■■
CCU RECEIVE LEVEL    ■■■■■

VERSION          xx.xx-xxx-xx.xx

```

Item	Display range	Remarks
BUTTON ASSIGN USER1	NONE CHARA BARS CLEAN	Displays the functionality assigned to the USER1 button on the LCD panel.
BUTTON ASSIGN USER2	NONE CHARA MENU/USER1 LOCK BARS CLEAN	Displays the functionality assigned to the USER2 button on the LCD panel.
HOURS CCU	*****H	Cumulative CCU operating time is displayed here.
CABLE OPEN	(Off)	This item flashes when the optical fiber multi cable is not connected.
CABLE SHORT	(Off)	This item flashes when the optical fiber multi cable is short-circuited.
CAM RECEIVE LEVEL	■■■■■	The level of the optical signals received by the camera is displayed in 5 gradations.
CCU RECEIVE LEVEL	■■■■■	The level of the optical signals received by the unit is displayed in 5 gradations.
VERSION	- - -	The unit's software version is displayed here.

Operation displays

The operation displays appear at the bottom of the screen for approx. 4 seconds when any of the following operations have been performed with the operation panel of the ROP.

- Master gain change
- Electronic shutter change
- Lens extender change
- Scene file change
- REF LOAD is changed
- FILTER is changed

The display time can be changed from [MAINTENANCE] menu > [PM OPERATION STATUS] > [STATUS DISPLAY TIME].



Item	Display range	Remarks
MASTER GAIN	Setting values on camera	The master gain value is displayed here. <ul style="list-style-type: none"> • For the setting values, refer to the Operating Instructions for the camera.
SHUTTER	Setting values on camera	The speed of the electronic shutter is displayed here. <ul style="list-style-type: none"> • For the setting values, refer to the Operating Instructions for the camera.
LENS EXT	1.0 2.0	The magnification of the lens extender is displayed here. <ul style="list-style-type: none"> • When the magnification of the lens extender is set to 2x, [2.0] is displayed. Otherwise, [1.0] is displayed.
SCENE FILE	OFF 1 to 8	This indicates the scene file name.
REF LOAD	FACTORY USER1 to USER3 REF1 to 3	This indicates the reference file that was loaded via reference call recalling.
FILTER	**** (ND/CC filter name)	The names of the ND filter/CC filters are displayed here.

Auto displays

When the following operation is performed while no menu is displayed on the picture monitor, information on the operation performed appears at the bottom of the screen.

- AWB (Auto White Balance) function
- ABB (Auto Black Balance) function
- AUTO SETUP (Auto Setup) function
- The AUTO SETUP function does not work when AK-PLV100 is connected.

When the AUTO SETUP operations are displayed, they will remain displayed until the operations are completed.

The display is cleared 4 seconds after the operations are completed.

If the operations cannot be completed, they will remain displayed until the NG (error) items of the AUTO function are released.

The display time can be changed from [MAINTENANCE] menu > [PM OPERATION STATUS] > [STATUS DISPLAY TIME].



Item	Display description
AWB	AWB : OK
	AWB : ACTIVE
	AWB : G/B/R NG
	AWB : LOW/HIGH LIGHT NG
	AWB : BREAK
ABB	ABB : OK
	ABB : ACTIVE
	ABB : G/B/R NG
	ABB : LENS OPEN
	ABB : BREAK
AUTO SETUP	AUTO SETUP : OK (Details on the operation are displayed at the bottom.)
	AUTO SETUP : NG (Details on the NG information are displayed at the bottom.)
	AUTO SETUP : BREAK

- **AUTO SETUP operation details**

Display description
B.SHD OPERATION
W.SHD OPERATION
GAMMA OPERATION
FLARE OPERATION
AWB OPERATION
ABB OPERATION
NOT RUNNING ILLEGAL MODE

LCD panel

Display switching of the LCD panel

Switch the display on the LCD panel using the following procedure:

1. **Touch the [PM] button on the LCD display screen or hold down the [MENU] button.**
Images output from the SDI output of the [HD SDI OUT(8/PM)] connector are displayed on the LCD panel.
2. **Press the [MENU] button.**
The CCU menu is displayed on the LCD panel.
3. **Touch and hold the LCD panel or hold down the [MENU] button.**
The LCD panel display switches to the LCD display screen.

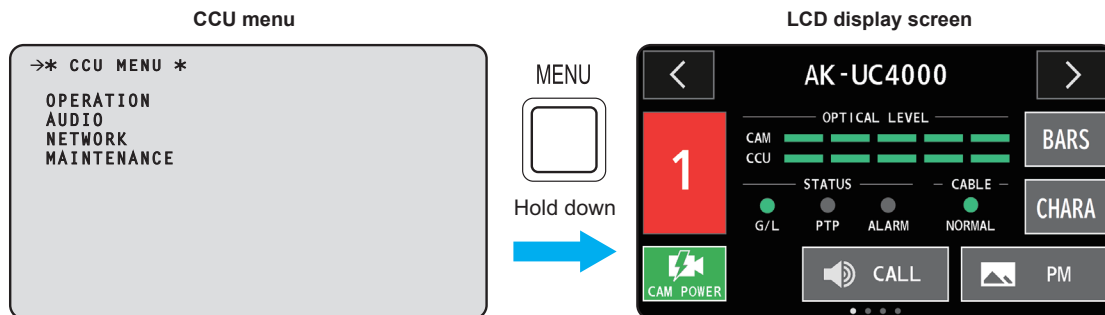

NOTE



- Turn the [SELECT] dial while the LCD display screen is displayed to change pages.

Buttons on the LCD panel

Functions are made available by operating the buttons on the LCD panel.

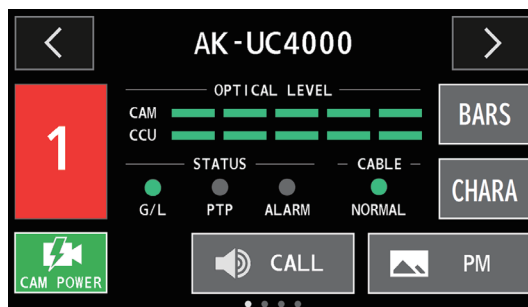
Camera screen



[>]	Touch the button to move to the next page.
[<]	Touch the button to move back to the previous page. <ul style="list-style-type: none"> The screens change in the order Camera screen ↔ [INTERCOM] screen ↔ [INFORMATION] screen ↔ [NETWORK] screen ↔ Camera screen ↔ ...
	You can turn the power of the camera on/off by continuing to touch this button.
	Calls the camera side and ROP side. It flashes red when a call is made.
	SDI output images output from the [HD SDI OUT(8/PM)] connector are displayed on the LCD panel. <ul style="list-style-type: none"> A message is displayed when you touch the button. Touch [OK]. Touch and hold the screen while the SDI output images from the [HD SDI OUT(8/PM)] connector are displayed to return to the LCD display screen.
[BARS] (USER1)	Touch the button to execute the functionality set in USER1. This can be set in the CCU menu. The button display changes depending on the settings.
[CHARA] (USER2)	Touch the button to execute the functionality set in USER2. This can be set in the CCU menu. The button display changes depending on the settings.
[OPTICAL LEVEL] indicators	<ul style="list-style-type: none"> [CAM] indicator Indicates the reception strength on the camera side. [CCU] indicator Indicates the reception strength on the CCU side.
[STATUS] indicators	<ul style="list-style-type: none"> [G/L] indicator Lights when the external sync signal is synchronized. [PTP] indicator Lights when PTP-synchronized. [ALARM] indicator Lights when the unit malfunctions.
[CABLE] indicator	Lights to indicate the cable connection status. <ul style="list-style-type: none"> Lights green when this unit and the camera are properly connected using an optical fiber multi cable.

[INTERCOM] screen

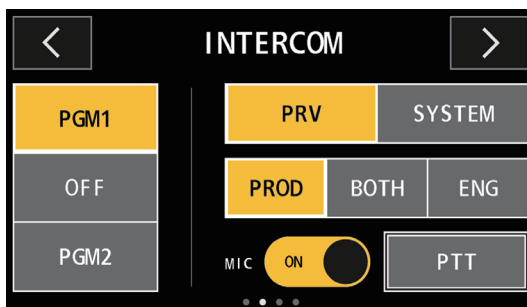

[PGM1]/[OFF]/[PGM2]	<p>This switch mixes audio for the intercom. Touch the button to change the setting. [PGM1]: The sound of PGM1 is mixed with the intercom sound. [OFF]: The sound of PGM is not mixed with the intercom sound. [PGM2]: The sound of PGM2 is mixed with the intercom sound.</p>
[PRV]/[SYSTEM]	<p>This switch is for selecting the party to call using the intercom. Touch the button to change the setting. [PRV]: For making private calls between the unit and camera side. [SYSTEM]: For calling the intercom on the system side and camera side.</p>
[PROD]/[BOTH]/[ENG]	<p>This switch selects the party to which to speak via the intercom. Touch the button to change the setting.</p>
[MIC ON]/ [MIC OFF]	<p>This switch switches the intercom microphone ON/OFF. Touch the button to change.</p>
[PTT]	<p>The intercom microphone is ON only while you are touching the button.</p>



[INFORMATION] screen

Displays error information, etc.



[NETWORK] screen

You can change a variety of network settings. ([IPv4 ADDRESS]/[SUBNET MASK]/[ROP ACCOUNT]/[DEFAULT GATEWAY]/[PORT])

- Touch the  button next to each item to switch to a screen for entering characters. After entering, touch the [SAVE] button to complete the entry.
Touch the [SET] button to complete the settings.
- Touch the [ROP ACCOUNT]  button to switch to the [ACCOUNT SETTING] screen.

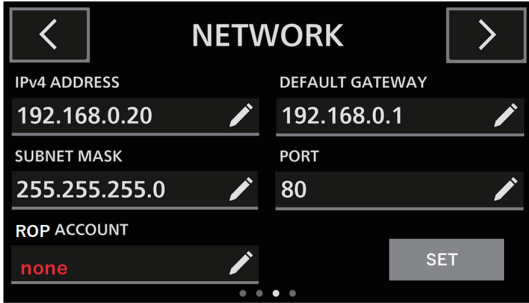
[ACCOUNT SETTING] screen

Enter the account settings items. ([OLD ID]/[OLD PASSWORD]/[NEW ID]/[NEW PASSWORD]/[PASSWORD RETYPE])

- The entered settings are updated when you touch [SAVE] and it returns to the [NETWORK] screen.
- The entered settings are left unchanged when you touch [CANCEL] and it returns to the [NETWORK] screen.

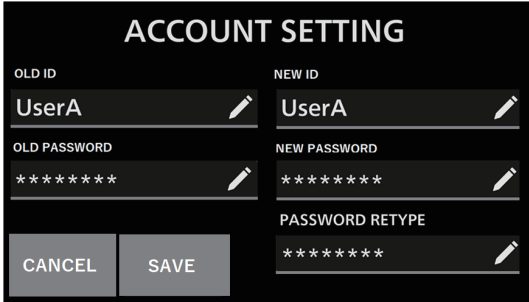
ID entry

- If not registered, the item name is displayed in red.
- Enter up to 8 alphanumeric characters.

Password entry

- If not registered, the item name is displayed in red.
- Enter 8 or more characters (a maximum of 16 characters).
Set a combination of the three types, alphabetical characters, numerical characters, and symbol characters. You cannot use the same character string as the ID.
- The available characters are as follows:

Alphabetical characters (upper and lower cases)	ABCDEFGHIJKLMNOPQRSTUVWXYZ abcdefghijklmnopqrstuvwxyz
Numeric characters	0123456789
Symbols	~!@#\$%^&*()_+\\ {}[]<>.,/'

About entering characters

Buttons other than the ones for characters act as described below.

Number input screen

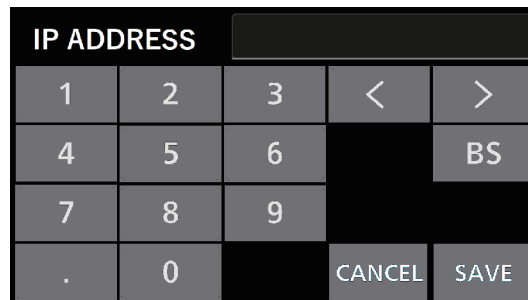

[< >]	Switches the item to be set.
[BS]	Deletes one character.

Letter input screen

Alphabet input screen

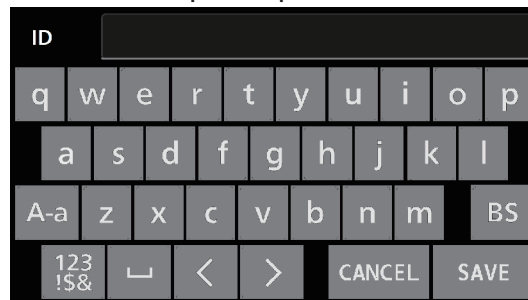

Number/symbol input screen 1

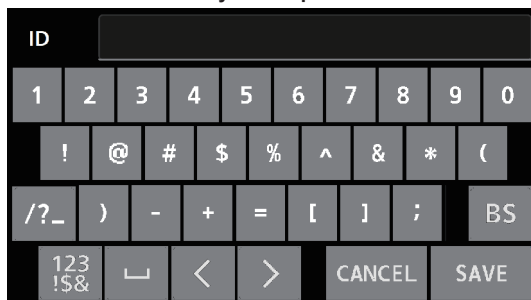

Number/symbol input screen 2

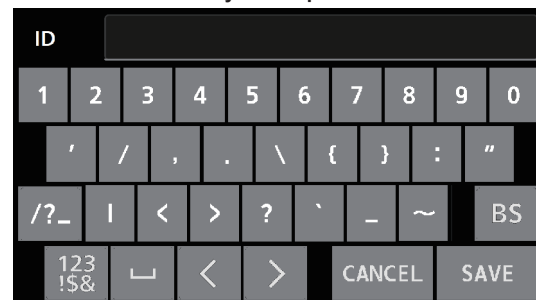

[BS]	Deletes one character.
␣	Enter a space.
[<]	Moves the cursor back one character.
[>]	Moves the cursor forward one character.
[A-a]	Switches between upper-case and lower-case.
123 !\$&	Switches between the alphabet input screen and the number/symbol input screen 1.
[/?_]	Switches between the number/symbol input screen 1 and the number/symbol input screen 2.

CCU menu

Menu operations

Display the CCU menu on the picture monitor and on the LCD panel of the unit, then operate using the [MENU] button and [SELECT] dial on the front panel.

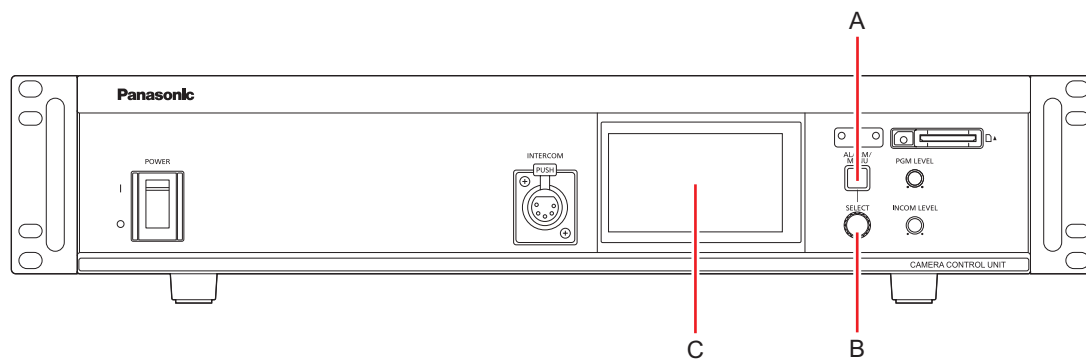

- A. [MENU] button
- B. [SELECT] dial
- C. LCD panel

NOTE

- If the LCD panel display is showing the LCD display screen, change to the CCU menu display.
➔ "Display switching of the LCD panel" (see page 34)

Displaying and hiding the menus

Menus are displayed or hidden by the following procedure.

1. Press the [MENU] button.

The [MENU] button lights white and the CCU menu is displayed on the picture monitor and the LCD panel.

When you press the [MENU] button again, the menu display ends and the [MENU] button turns off.

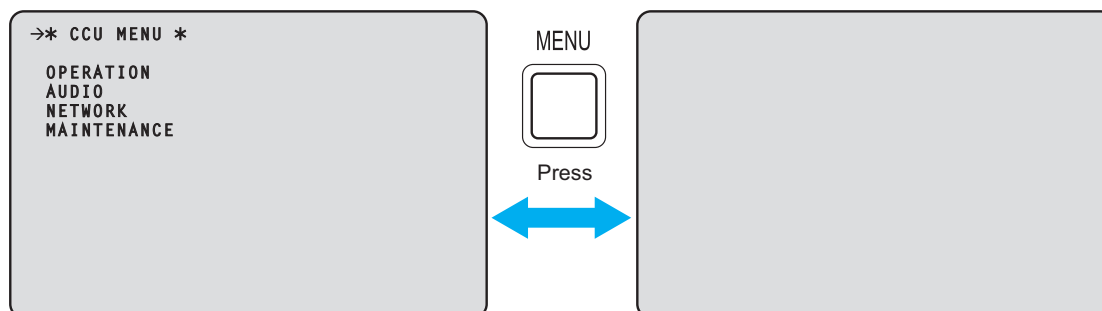

Basic menu operations

Menu items are selected and set by the following procedure.

1. Turn the [SELECT] dial while in the [CCU MENU], select [OPERATION] or [MAINTENANCE], and then press the [SELECT] dial.

A list of menu items included in the selected item ([OPERATION] or [MAINTENANCE]) is displayed.

- When the [SELECT] dial is turned clockwise, the cursor moves down; conversely, when it is turned counterclockwise, the cursor moves up.

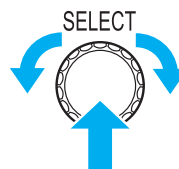
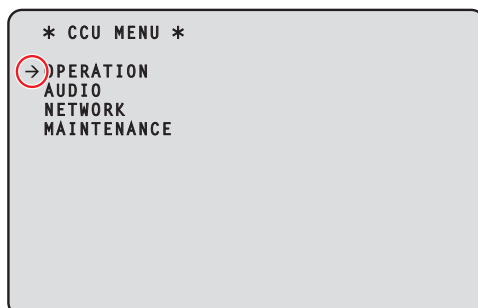

2. Turn the [SELECT] dial to move the cursor to the menu item you want to set, and then press the [SELECT] dial.

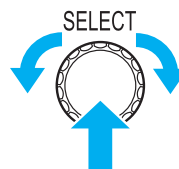
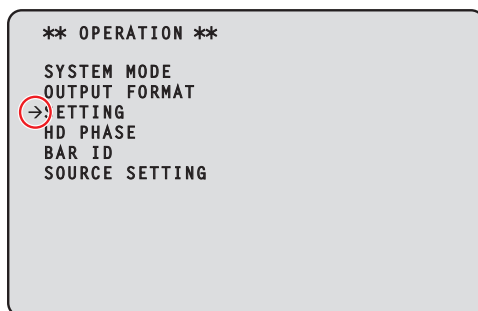

The setting screen one level below the selected menu item appears.

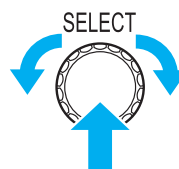
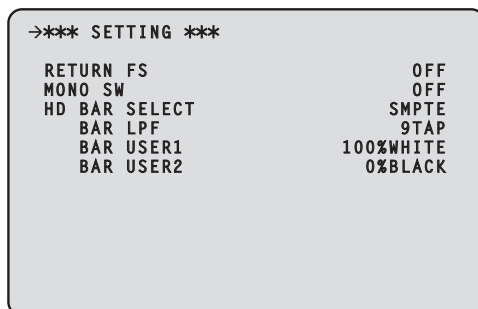

- Moving the cursor to the menu title and then pressing the [SELECT] dial redisplay [CCU MENU].

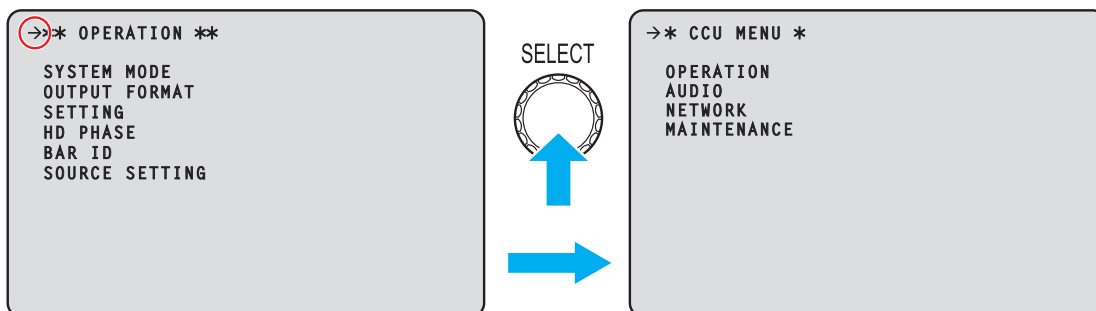

3. Turn the [SELECT] dial to move the cursor to the menu item you want to set, and then press the [SELECT] dial.

The setting value of the selected menu item starts flashing and you can change it.

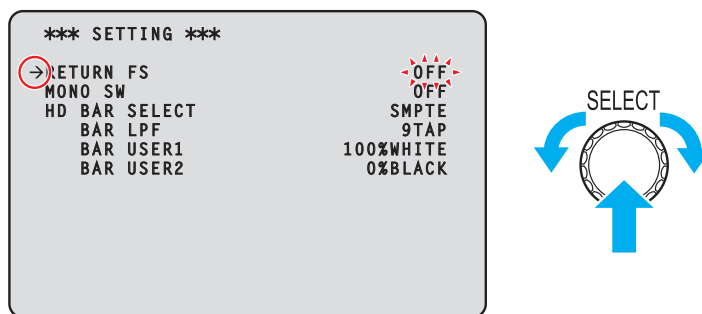

4. Turn the [SELECT] dial to change the value, and then press the [SELECT] dial.

Turning the [SELECT] dial changes the setting value and pressing the [SELECT] dial confirms the setting value.

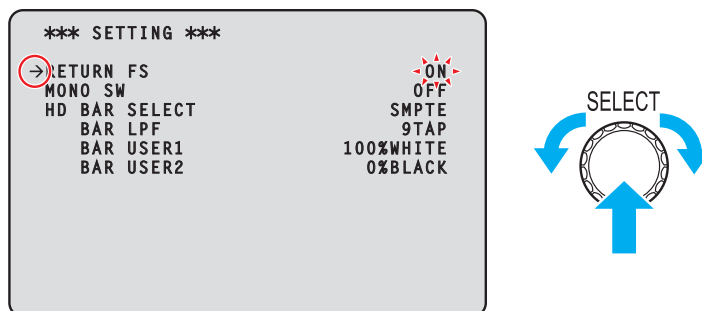

When the setting value is confirmed and the flashing stops, you can move the cursor.

With some menu items, setting changes become effective while the setting value is in the flashing state; with others, changes become effective when the [SELECT] dial is pressed to confirm the setting value.

Operation with menu items that have multiple setting items on one line

1. Turn the [SELECT] dial to move the cursor to the menu item you want to set, and then press the [SELECT] dial.

The cursor becomes "↓" and you can use the [SELECT] dial to move the cursor to a setting item in the selected menu item.

*** BAR ID ***		
BAR ID SWITCH		OFF
BRIGHTNESS		100%
ID1 POSITION	↓:00	H:00
ID1		0000
ID2 POSITION	V:00	H:00
ID2		2222
OFFSET	V:000	H:000

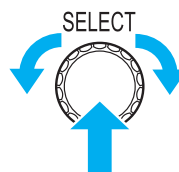

2. Turn the [SELECT] dial to move the cursor to the item you want to set, and then press the [SELECT] dial.

The setting value of the selected item starts flashing and you can change it.

*** BAR ID ***		
BAR ID SWITCH		OFF
BRIGHTNESS		100%
ID1 POSITION	V:00 ↓:00	H:00
ID1		0000
ID2 POSITION	V:00	H:00
ID2		2222
OFFSET	V:000	H:000

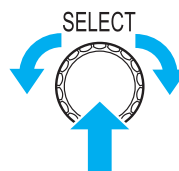

3. Turn the [SELECT] dial to change the value, and then press the [SELECT] dial.

Turning the [SELECT] dial changes the setting value and pressing the [SELECT] dial confirms the setting value.

*** BAR ID ***		
BAR ID SWITCH		OFF
BRIGHTNESS		100%
ID1 POSITION	V:00 ↓:05	H:00
ID1		0000
ID2 POSITION	V:00	H:00
ID2		2222
OFFSET	V:000	H:000

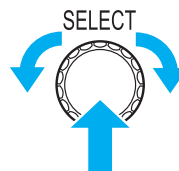

When the setting value is confirmed and the flashing stops, you can move the cursor.

If you press the [SELECT] dial while the cursor is on the left of a menu item, the cursor becomes "→" and you can select the menu item.

*** BAR ID ***		
BAR ID SWITCH		OFF
BRIGHTNESS		100%
→ ID1 POSITION	V:00	H:05
ID1		0000
ID2 POSITION	V:00	H:00
ID2		2222
OFFSET	V:000	H:000



Text input

1. Turn the [SELECT] dial to move the cursor to the menu item where text is to be input, and then press the [SELECT] dial.

The cursor display changes as indicated by "↓". By turning the [SELECT] dial, you can move the cursor to the next (previous) character position.

*** BAR ID ***		
BAR ID SWITCH		OFF
BRIGHTNESS		100%
ID1 POSITION	V:00	H:00
ID1		0000
ID2 POSITION	V:00	H:00
ID2		2222
OFFSET	V:000	H:000

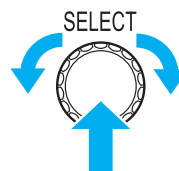

2. Turn the [SELECT] dial to move the cursor to position where a character is to be input, and then press the [SELECT] dial.

The selected character starts flashing and you can change it.

*** BAR ID ***		
BAR ID SWITCH		OFF
BRIGHTNESS		100%
ID1 POSITION	V:00	H:00
ID1		0000
ID2 POSITION	V:00	H:00
ID2		2222
OFFSET	V:000	H:000

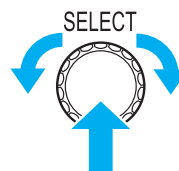

3. Turn the [SELECT] dial to change the character, and then press the [SELECT] dial.

Turning the [SELECT] dial changes characters, and pressing the [SELECT] dial confirms character changes.

*** BAR ID ***		
BAR ID SWITCH		OFF
BRIGHTNESS		100%
ID1 POSITION	V:00	H:00
ID1		0001
ID2 POSITION	V:00	H:00
ID2		2222
OFFSET	V:000	H:000

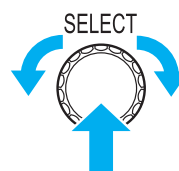

When a character has been input and the flashing stops, you can move the cursor.

If you press the [SELECT] dial while the cursor is on the left of a menu item, the cursor becomes "→" and you can select the menu item.

*** BAR ID ***		
BAR ID SWITCH		OFF
BRIGHTNESS		100%
ID1 POSITION	V:00	H:00
→ ID1		0001
ID2 POSITION	V:00	H:00
ID2		2222
OFFSET	V:000	H:000



NOTE

- Turning the [SELECT] dial clockwise while pressing it increases the speed at which the number increases (turning it counterclockwise decreases the number). Turning the dial more increases the speed even more. This operation is effective for making a large change to a value when the setting width is large (e.g., IP address or port number).

CCU MENU

This is the first screen displayed when you press the [MENU] button.

Select one of the menus.

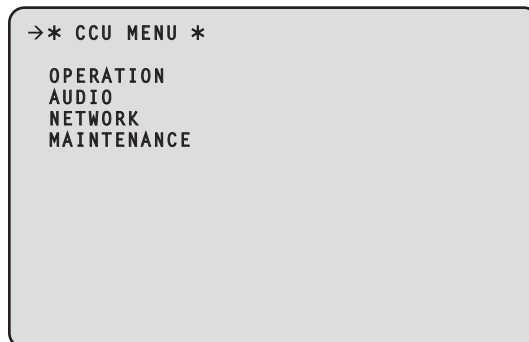

Item	Content	Details page
OPERATION	Open the OPERATION menu screen.	➔ "OPERATION" (see page 46)
AUDIO	Open the AUDIO menu screen.	➔ "AUDIO" (see page 55)
NETWORK	Open the NETWORK menu screen.	➔ "NETWORK" (see page 61)
MAINTENANCE	Open the MAINTENANCE menu screen.	➔ "MAINTENANCE" (see page 81)

OPERATION

This is the selection screen for the OPERATION menu.

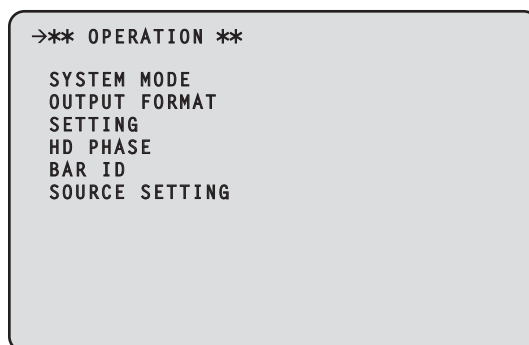

Item	Content	Details page
SYSTEM MODE	Display the SYSTEM MODE menu.	➔ "SYSTEM MODE" (see page 47)
OUTPUT FORMAT	Display the OUTPUT FORMAT menu.	➔ "OUTPUT FORMAT" (see page 49)
SETTING	Display the SETTING menu.	➔ "SETTING" (see page 51)
HD PHASE	Display the HD PHASE menu.	➔ "HD PHASE" (see page 52)
BAR ID	Display the BAR ID menu.	➔ "BAR ID" (see page 53)
SOURCE SETTING	Display the SOURCE SETTING menu.	➔ "SOURCE SETTING" (see page 54)

SYSTEM MODE

This is the selection screen for the SYSTEM MODE menu.

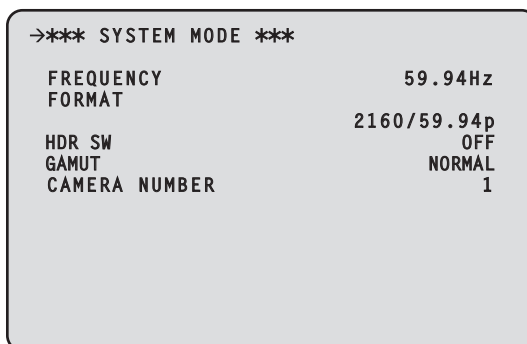

___ indicates factory default settings.

Item	Setting value	Setting details
FREQUENCY	<u>59.94Hz</u> ^{*1} <u>50Hz</u> ^{*2}	Sets the frequency for the CCU.
FORMAT	<FREQUENCY: 59.94Hz> <u>2160/59.94p</u> ^{*1} , 2160/29.97p, 2160/23.98p, 1080/59.94p, 1080/29.97p, 1080/23.98p, 2160/59.94p-120fps, 1080/59.94p-240fps, 1080/59.94p-180fps, 1080/59.94p-120fps <FREQUENCY: 50Hz> <u>2160/50p</u> ^{*2} , 2160/25p, 1080/50p, 1080/25p, 2160/50p-100fps, 1080/50p-200fps, 1080/50p-150fps, 1080/50p-100fps	Set the CCU format. <ul style="list-style-type: none"> The unit restarts automatically when the format is changed. The following setting values cannot be selected when AK-UC3300 is connected: <ul style="list-style-type: none"> [1080/59.94p-240fps] [1080/59.94p-180fps] [720/59.94p-240fps] [720/59.94p-180fps] [1080/50p-200fps] [1080/50p-150fps] [720/50p-200fps] [720/50p-150fps] ➡ "FREQUENCY and FORMAT Conditions" (see page 48)
HDR SW	ON <u>OFF</u>	Enables/disables HDR.
GAMUT	<u>NORMAL</u> WIDE_G2	Change the color gamut.
CAMERA NUMBER	<u>1</u> to 99	Sets the camera number displayed on the camera, CCU LCD panel, and ROP.

*1: AK-UCU700P/700PS/710P/710PS

*2: AK-UCU700E/700ES/710E/710ES

FREQUENCY and FORMAT Conditions

FREQUENCY/FORMAT	UHD/HS/HD SDI OUT				HD SDI OUT			
	1	2	3	4	5	6	7	8/PM
59.94Hz								
2160/59.94p	12G: 2160/59.94p		no signal		3G: 1080/59.94p		HD: 1080/59.94i	
	3Gx4(2SI): 2160/59.94p				HD: 1080/59.94i			
2160/29.97p	6G: 2160/29.97p		no signal		TrueP: 1080/29.97p			
					PsF: 1080/29.97PsF			
					Over3G: 1080/29.97p over 59.94p		-	
2160/23.98p	6G: 2160/23.98p		no signal		TrueP: 1080/23.98p			
					PsF: 1080/23.98PsF			
					Over3G: 1080/23.98p over 59.94p		OverHD: 1080/23.98p over 59.94i	
1080/59.94p	3G: 1080/59.94p				3G: 1080/59.94p		HD: 1080/59.94i	
	HD: 1080/59.94i				HD: 1080/59.94i			
1080/29.97p	TrueP: 1080/29.97p				TrueP: 1080/29.97p			
	PsF: 1080/29.97PsF				PsF: 1080/29.97PsF			
	Over3G: 1080/29.97p over 59.94p				Over3G: 1080/29.97p over 59.94p		-	
1080/23.98p	TrueP: 1080/23.98p				TrueP: 1080/23.98p			
	PsF: 1080/23.98PsF				PsF: 1080/23.98PsF			
	Over3G: 1080/23.98p over 59.94p				Over3G: 1080/23.98p over 59.94p		OverHD: 1080/23.98p over 59.94i	
1080/59.94p-240fps	3G: 1080/59.94p-240fps				3G: 1080/59.94p		HD: 1080/59.94i	
	HD: 1080/59.94i-240fps				HD: 1080/59.94i			
1080/59.94p-180fps	3G: 1080/59.94p-180fps		no signal		3G: 1080/59.94p		HD: 1080/59.94i	
	HD: 1080/59.94i-180fps				HD: 1080/59.94i			
1080/59.94p-120fps	3G: 1080/59.94p-120fps		no signal		3G: 1080/59.94p		HD: 1080/59.94i	
	HD: 1080/59.94i-120fps				HD:1080/59.94i			
50Hz								
2160/50p	12G: 2160/50p		no signal		3G: 1080/50p		HD: 1080/50i	
	3Gx4(2SI): 2160/50p				HD: 1080/50i			
2160/25p	6G: 2160/25p		no signal		TrueP: 1080/25p			
					PsF: 1080/25PsF			
					Over3G: 1080/25p over 50p		-	
1080/50p	3G: 1080/50p				3G: 1080/50p		HD: 1080/50i	
	HD: 1080/50i				HD: 1080/50i			
1080/25p	TrueP: 1080/25p				TrueP: 1080/25p			
	PsF: 1080/25PsF				PsF: 1080/25PsF			
	Over3G: 1080/25p over 50p				Over3G: 1080/25p over 50p		-	
1080/50p-200fps	3G: 1080/50p-200fps				3G: 1080/50p		HD: 1080/50i	
	HD: 1080/50i-200fps				HD: 1080/50i			
1080/50p-150fps	3G: 1080/50p-150fps		no signal		3G: 1080/50p		HD: 1080/50i	
	HD: 1080/50i-150fps				HD: 1080/50i			
1080/50p-100fps	3G: 1080/50p-100fps		no signal		3G: 1080/50p		HD: 1080/50i	
	HD: 1080/50i-100fps				HD: 1080/50i			

OUTPUT FORMAT

This is the selection screen for the OUTPUT FORMAT menu.

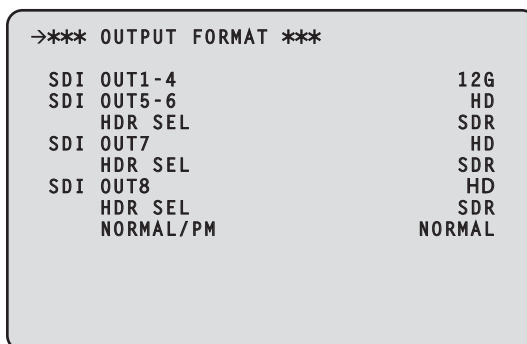

___ indicates factory default settings.

Item	Setting value	Setting details
SDI OUT1-4 SDI OUT1	<ul style="list-style-type: none"> ● FORMAT: 2160/59.94p, 2160/50p 12G, 3Gx4(2SI) 	Set the format of the signal output from the [UHD/HS/HD SDI OUT(1 to 4)] connectors.
SDI OUT1-4 SDI OUT2	<ul style="list-style-type: none"> ● FORMAT: 2160/29.97p, 2160/25p, 2160/23.98p 6G ● FORMAT: 2160/59.94p-120fps, 2160/50p-100fps 12G 	
SDI OUT1-4 SDI OUT3	<ul style="list-style-type: none"> ● FORMAT: 1080/59.94p, 1080/50p 3G, HD ● FORMAT: 1080/29.97p, 1080/25p, 1080/23.98p TrueP, PsF, Over3G 	
SDI OUT1-4 SDI OUT4	<ul style="list-style-type: none"> ● FORMAT: 1080/59.94p-240fps, 1080/59.94p-180fps, 1080/59.94p-120fps, 1080/50p-200fps, 1080/50p-150fps, 1080/50p-100fps 3G, HD 	
SDI OUT5-6 SDI OUT5	<ul style="list-style-type: none"> ● FORMAT: 2160/59.94p, 2160/50p 3G, HD ● FORMAT: 2160/29.97p, 2160/25p, 2160/23.98p TrueP, PsF, Over3G ● FORMAT: 2160/59.94p-120fps, 2160/50p-100fps 3G, HD 	Set the format of the signal output from the [HD SDI OUT(5 to 6)] connectors.
SDI OUT5-6 SDI OUT6	<ul style="list-style-type: none"> ● FORMAT: 1080/59.94p, 1080/50p 3G, HD ● FORMAT: 1080/29.97p, 1080/25p, 1080/23.98p TrueP, PsF, Over3G ● FORMAT: 1080/59.94p-240fps, 1080/59.94p-180fps, 1080/59.94p-120fps, 1080/50p-200fps, 1080/50p-150fps, 1080/50p-100fps 3G, HD 	
SDI OUT5-6 HDR SEL	SDR HDR	Change HDR setting of the signal output from the [HD SDI OUT(5 to 6)] connectors.
SDI OUT7	<ul style="list-style-type: none"> ● FORMAT: 2160/59.94p, 2160/50p 3G, HD ● FORMAT: 2160/29.97p, 2160/25p, 2160/23.98p TrueP, PsF, Over3G ● FORMAT: 2160/59.94p-120fps, 2160/50p-100fps 3G, HD ● FORMAT: 1080/59.94p, 1080/50p 3G, HD ● FORMAT: 1080/29.97p, 1080/25p, 1080/23.98p TrueP, PsF, Over3G ● FORMAT: 1080/59.94p-240fps, 1080/59.94p-180fps, 1080/59.94p-120fps, 1080/50p-200fps, 1080/50p-150fps, 1080/50p-100fps 3G, HD 	Sets the format of the signal output from the [HD SDI OUT(7)] connector.
SDI OUT7 HDR SEL	SDR HDR	Change HDR setting of the signal output from the [HD SDI OUT(7)] connector.

Item	Setting value	Setting details
SDI OUT8	<ul style="list-style-type: none"> ● FORMAT: 2160/59.94p, 2160/50p <u>HD</u> ● FORMAT: 2160/29.97p, 2160/25p <u>TrueP, PsF</u> ● FORMAT: 2160/23.98p <u>TrueP, PsF, Over1.5G</u> ● FORMAT: 2160/59.94p-120fps, 2160/50p-100fps <u>HD</u> ● FORMAT: 1080/59.94p, 1080/50p <u>HD</u> ● FORMAT: 1080/29.97p, 1080/25p <u>TrueP, PsF</u> ● FORMAT: 1080/23.98p <u>TrueP, PsF, Over1.5G</u> ● FORMAT: 1080/59.94p-240fps, 1080/59.94p-180fps, 1080/59.94p-120fps, 1080/50p-200fps, 1080/50p-150fps, 1080/50p-100fps <u>HD</u> 	Sets the format of the signal output from the [HD SDI OUT(8)] connector.
SDI OUT8 HDR SEL	<u>SDR</u> <u>HDR</u>	Change HDR setting of the signal output from the [HD SDI OUT(8)] connector.
SDI OUT8 NORMAL/PM	<u>PM</u> <u>NORMAL</u>	Set the signal output from the [HD SDI OUT(8/PM)] connector. <ul style="list-style-type: none"> ● PM: Output the picture monitor images. ● NORMAL: Output the main line images.

SETTING

This is the selection screen for the SETTING menu.

```

->*** SETTING ***

RETURN FS                OFF
MONO SW                  OFF
HD BAR SELECT            SMPTE
BAR LPF                  9TAP
BAR USER1               100%WHITE
BAR USER2               0%BLACK
  
```

___ indicates factory default settings.

Item	Setting value	Setting details
RETURN FS	ON <u>OFF</u>	Set the delay mode for the HD return signals.
MONO SW	ON <u>OFF</u>	Set CCU output video to monochrome.
HD BAR SELECT	STD <u>SMPTE</u> ARIB EIAJ SPLIT	Set the color bar signal for output with the HD signal.
HD BAR LPF	OFF 3TAP 5TAP 7TAP <u>9TAP</u>	Set the filter to be applied to the color bar signal output with the HD signal.
HD BAR USER1	75%WHITE <u>100%WHITE</u> +I_SIGNAL -I_SIGNAL	Set user selection 1 for when [ARIB] has been selected as the [HD BAR SELECT] setting.
HD BAR USER2	0%BLACK <u>+Q_SIGNAL</u>	Set user selection 2 for when [ARIB] has been selected as the [HD BAR SELECT] setting.

HD PHASE

This is the selection screen for the HD PHASE menu.

```

->*** HD PHASE ***
HD H COARSE          0
HD H FINE            0
V ADVANCE            0
  
```

___ indicates factory default settings.

Item	Setting value	Setting details
HD H COARSE	-127 to <u>0</u> to +127	Make the coarse setting of the H_FINE phase used with GL HD REF.
HD H FINE	-100 to <u>0</u> to +100	Make the fine setting of the H_FINE phase used with GL HD REF.
V ADVANCE	-3 / -2 / -1 / <u>0</u>	<p>Set the vertical phase of this unit in relation to the vertical phase of the REF signal. The larger the negative value, the larger the advance. The setting unit varies depending on [FORMAT].</p> <ul style="list-style-type: none"> When the mode is [1080/23.98p], the setting unit is 1H of [1080/23.98p]. Otherwise, the setting unit is 1H of [1080/59i] or [1080/50i].

BAR ID

This is the selection screen for the BAR ID menu.

```

->*** BAR ID ***

BAR ID SWITCH                OFF
BRIGHTNESS                   100%
ID1 POSITION                   V:00 H:00

ID1                          ##

ID2 POSITION                   V:01 H:00

ID2 OFFSET                   V:00 H:00
  
```

___ indicates factory default settings.

Item	Setting value	Setting details
BAR ID SWITCH	ON OFF	Set display of the camera ID in the color bar ON or OFF.
BRIGHTNESS	0 to <u>100%</u>	Set the text color for the camera ID in the color bar. <ul style="list-style-type: none"> The setting can be made in 10% steps. 0 : Black 100%: White
ID1 POSITION V	<u>00</u> to 05	Set the starting position (vertical) for display of camera ID1 in the color bar. <ul style="list-style-type: none"> Set from which character in the vertical direction, starting from the top left of the color bar, to start displaying the BAR ID using the font size as the reference.
ID1 POSITION H	<u>00</u> to 15	Set the starting position (horizontal) for display of camera ID1 in the color bar. <ul style="list-style-type: none"> Set from which character in the horizontal direction in the color bar to start displaying the BAR ID using the font size as the reference.
ID1	<u>##</u> (Max. 16 characters)	Set camera ID1. This ID is displayed in the color bar. Characters which can be used: Alphanumeric characters, spaces, ! # % & ' () * + , - . / : ; < = > ? [] _ ~ <ul style="list-style-type: none"> If "##" is input, that portion is replaced with the camera number (1 to 15) being managed by the CCU.
ID2 POSITION V	00, <u>01</u> to 05	Set the starting position (vertical) for display of camera ID2 in the color bar. <ul style="list-style-type: none"> Set from which character in the vertical direction, starting from the top left of the color bar, to start displaying the BAR ID using the font size as the reference.
ID2 POSITION H	<u>00</u> to 15	Set the starting position (horizontal) for display of camera ID2 in the color bar. <ul style="list-style-type: none"> Set from which character in the horizontal direction in the color bar to start displaying the BAR ID using the font size as the reference.
ID2	<u>Spaces</u> (Max. 16 characters)	Set camera ID2. This ID is displayed in the color bar. Characters which can be used: Alphanumeric characters, spaces, ! # % & ' () * + , - . / : ; < = > ? [] _ ~ <ul style="list-style-type: none"> If "##" is input, that portion is replaced with the camera number (1 to 99) being managed by the CCU.
OFFSET V	<u>00</u> to 89	Specify the origin (upper left) in the vertical direction of the character drawing area in pixels.
OFFSET H	<u>00</u> to 79	Specify the origin (upper left) in the horizontal direction of the character drawing area in pixels.

NOTE

- When the coordinates of ID1 and ID2 are the same, BAR ID1's character string will be placed on top of BAR ID2 (BAR ID2 will be on the bottom). When the vertical coordinates are the same and the horizontal coordinates differ, the BAR ID with the horizontal coordinates set later will be placed on top.

SOURCE SETTING

This is the selection screen for the SOURCE SETTING menu.

```

->** SOURCE SETTING **

REF SIGNAL          BB/TRI-LEVEL
RETURN SIGNAL       SDI
PROMPTER SIGNAL     SDI
NDI/SRT SELECT      -----
NDI/SRT OUT SIGNAL  -----
INCOM/PGM SIGNAL    NORMAL
AUX OUT SIGNAL      SDI_RET1
  
```

___ indicates factory default settings.

Item	Setting value	Setting details
REF SIGNAL	<u>BB/TRI-LEVEL</u> PTP	Selects the input connector for reference signals. <ul style="list-style-type: none"> This is fixed to [BB/TRI-LEVEL] when AK-NP701 is not attached.
RETURN SIGNAL	SDI ST2110 NDI/SRT	Selects the input connector for the return signals. <ul style="list-style-type: none"> [ST2110] cannot be selected when AK-NP701 is not attached. [NDI/SRT] cannot be selected when AK-NP703 is not attached.
PROMPTER SIGNAL	SDI ST2110 NDI/SRT	Selects the input connector for the PROMPTER signal. <ul style="list-style-type: none"> [ST2110] cannot be selected when AK-NP701 is not attached. [NDI/SRT] cannot be selected when AK-NP703 is not attached.
NDI/SRT SELECT	NDI SRT	Selects the protocol output by the Streaming connector. <ul style="list-style-type: none"> Displayed as "-----" when AK-NP703 is not attached.
NDI/SRT OUT SIGNAL	CAM MONI TRUNK	Selects the signal output by the Streaming connector. <ul style="list-style-type: none"> Displayed as "-----" when AK-NP703 is not attached.
INCOM/PGM SIGNAL	<u>NORMAL</u> ST2110 DANTE	Selects the signal used with INCOM/PGM. <ul style="list-style-type: none"> This is fixed to [NORMAL] when neither AK-NP701 nor AK-NP702 is attached. [ST2110] can be selected when AK-NP701 is attached. [DANTE] can be selected when AK-NP702 is attached.
AUX OUT SIGNAL	SDI_RET1 SDI_RET2 SDI_RET3 SDI_RET4 ST2110_RET NDI/SRT	Selects the signal output with AUX OUT.

AUDIO

This is the selection screen for the AUDIO menu.

```

->*** AUDIO **

MIC OUT
CCU INTERCOM TALK
CCU INTERCOM RECEIVE
COMMUNICATION
INTERCOM1
INTERCOM2
PGM
MoIP FORMAT
  
```

Item	Content	Details page
MIC OUT	Display the MIC OUT menu.	➔ "MIC OUT" (see page 55)
CCU INTERCOM TALK	Display the CCU INTERCOM TALK menu.	➔ "CCU INTERCOM TALK" (see page 56)
CCU INTERCOM RECEIVE	Display the CCU INTERCOM RECEIVE menu.	➔ "CCU INTERCOM RECEIVE" (see page 56)
COMMUNICATION	Display the COMMUNICATION menu.	➔ "COMMUNICATION" (see page 57)
INTERCOM1	Display the INTERCOM1 menu.	➔ "INTERCOM1" (see page 58)
INTERCOM2	Display the INTERCOM2 menu.	➔ "INTERCOM2" (see page 59)
PGM	Display the PGM menu.	➔ "PGM" (see page 60)
MoIP FORMAT	Sets the audio input and output formats for MOIP. (Enabled only when option AK-NP701 is attached.)	➔ "MoIP FORMAT" (see page 60)

MIC OUT

This is the selection screen for the MIC OUT menu.

```

->*** MIC OUT ***

MIC1 OUT      GAIN: 0dB LV: 0dB
MIC2 OUT      GAIN: 0dB LV: 0dB
  
```

___ indicates factory default settings.

Item	Setting value	Setting details
MIC1 OUT GAIN	<u>0dB</u> +4dB	This switches the analog output gain for MIC1.
MIC1 OUT LV	-40dB to <u>0dB</u> to +20dB	This adjusts the analog output level for MIC1.
MIC2 OUT GAIN	<u>0dB</u> +4dB	This switches the analog output gain for MIC2.
MIC2 OUT LV	-40dB to <u>0dB</u> to +20dB	This adjusts the analog output level for MIC2.

CCU INTERCOM TALK

This is the selection screen for the CCU INTERCOM TALK menu.

```

->*** CCU INTERCOM TALK ***

MIC TYPE                DYN
MIC POWER               OFF
MIC GAIN                0dB
SIDE TONE               -6dB
CCU INCOM ON/OFF       ON
  
```

___ indicates factory default settings.

Item	Setting value	Setting details
MIC TYPE	<u>DYN</u> ECM CBN	Select the type of intercom microphone.
MIC POWER	ON <u>OFF</u>	Set the power supply of the intercom microphone to ON or OFF.
MIC GAIN	-40dB to <u>0dB</u> to +12dB (1dB Step)	This is the volume control of the intercom microphone.
SIDE TONE	OFF -36dB to <u>-6dB</u> to 0dB	This is the volume control of the intercom microphone side tone.
CCU INCOM ON/OFF	<u>ON</u> OFF	Set the intercom to ON or OFF.

CCU INTERCOM RECEIVE

This is the selection screen for the CCU INTERCOM RECEIVE menu.

```

->*** CCU INTERCOM RECEIVE ***

CCU
  INCOM VR MIN MODE      MUTE
  PGM VR MIN MODE        MUTE
  CCU INCOM OUT GAIN     NORMAL
  ENG MIX CH2            OFF
  PROD MIX CH2           OFF
  PGM1 MIX CH2           OFF
  PGM2 MIX CH2           OFF
  
```

___ indicates factory default settings.

Item	Setting value	Setting details
CCU INCOM VR MIN MODE	<u>MUTE</u> MIN_GAIN	Set the minimum intercom volume level.
PGM VR MIN MODE	<u>MUTE</u> MIN_GAIN	Set the minimum PGM volume level.
CCU INCOM OUT GAIN	<u>NORMAL</u> BOOST	Switch the intercom output level.
ENG MIX CH2	ON <u>OFF</u>	Set whether to mix the ENG signal with the intercom's CH2 output. <ul style="list-style-type: none"> Not displayed when "INCOM CONNECTOR = XLR 4pin".
PROD MIX CH2	ON <u>OFF</u>	Set whether to mix the PROD signal with the intercom's CH2 output. <ul style="list-style-type: none"> Not displayed when "INCOM CONNECTOR = XLR 4pin".
PGM1 MIX CH2	ON <u>OFF</u>	Set whether to mix the PGM1 signal with the intercom's CH2 output. <ul style="list-style-type: none"> Not displayed when "INCOM CONNECTOR = XLR 4pin".
PGM2 MIX CH2	ON <u>OFF</u>	Set whether to mix the PGM2 signal with the intercom's CH2 output. <ul style="list-style-type: none"> Not displayed when "INCOM CONNECTOR = XLR 4pin".

COMMUNICATION

This is the selection screen for the COMMUNICATION menu.

```

->*** COMMUNICATION ***

INCOM1 ENG/PROD          ENG
INCOM2 ENG/PROD          PROD
PRIV/SYSTEM SW          ENG
  
```

___ indicates factory default settings.

Item	Setting value	Setting details
INCOM1 ENG/PROD	ENG PROD	Set the intercom 1 voice line of the communication connector.
INCOM2 ENG/PROD	ENG PROD	Set the intercom 2 voice line of the communication connector.
PRIV/SYSTEM SW	ENG PROD BOTH OFF INCOM1 INCOM2	Set the voice assignment of the [PRIV/SYSTEM] switch.

INTERCOM1

This is the selection screen for the INTERCOM1 menu.

```

->*** INTERCOM1 ***

 4W/RTS/CLRCOM           4W
 4W INPUT GAIN           0dB
 4W INPUT LEVEL          0dB
 4W OUTPUT LEVEL         0dB
 RTS INPUT LEVEL         0dB
 RTS OUTPUT LEVEL        0dB
 RTS CANCEL LEVEL        0.0dB
 CLRCOM INPUT LEVEL      0dB
 CLRCOM OUTPUT LEVEL     0dB
 CLRCOM CANCEL LEVEL     0.0dB
 RTS/CLRCOM LOAD         OFF

```

___ indicates factory default settings.

Item	Setting value	Setting details
4W/RTS/CLRCOM	4W RTS CLRCOM	Select the intercom 1 voice I/O method.
4W INPUT GAIN	0dB 20dB	Switch the 4W (intercom 1) input gain.
4W INPUT LEVEL	-40dB to 0dB to +20dB (1dB Step)	Switch the 4W (intercom 1) input level.
4W OUTPUT LEVEL	-40dB to 0dB to +20dB (1dB Step)	Switch the 4W (intercom 1) output level.
RTS INPUT LEVEL	-40dB to 0dB to +20dB (1dB Step)	Switch the RTS (intercom 1) input level.
RTS OUTPUT LEVEL	-40dB to 0dB to +20dB (1dB Step)	Switch the RTS (intercom 1) output level.
RTS CANCEL LEVEL	-20.0dB to +20.0dB *1 (0.5dB Step)	Switch the RTS (intercom 1) I/O cancellation level.
CLRCOM INPUT LEVEL	-40dB to 0dB to +20dB (1dB Step)	Set the clear-com (intercom 1) input volume.
CLRCOM OUTPUT LEVEL	-40dB to 0dB to +20dB (1dB Step)	Set the clear-com (intercom 1) output volume.
CLRCOM CANCEL LEVEL	-20.0dB to +20.0dB *1 (0.5dB Step)	Adjust the clear-com (intercom 1) I/O cancellation signal level.
RTS/CLRCOM LOAD	ON OFF	Switch ON or OFF for the intercom 1 RTS/CLRCOM 200 Ω load.

*1: The default setting varies depending on adjustment at the factory.

INTERCOM2

This is the selection screen for the INTERCOM2 menu.

```

->*** INTERCOM2 ***

4W/RTS/CLRCOM           4W
4W INPUT GAIN           0dB
4W INPUT LEVEL          0dB
4W OUTPUT LEVEL         0dB
RTS INPUT LEVEL         0dB
RTS OUTPUT LEVEL        0dB
RTS CANCEL LEVEL        0.0dB
CLRCOM INPUT LEVEL      0dB
CLRCOM OUTPUT LEVEL     0dB
CLRCOM CANCEL LEVEL     0.0dB
RTS/CLRCOM LOAD         OFF
  
```

___ indicates factory default settings.

Item	Setting value	Setting details
4W/RTS/CLRCOM	4W RTS CLRCOM	Select the intercom 2 voice I/O method.
4W INPUT GAIN	0dB 20dB	Switch the 4W (intercom 2) input gain.
4W INPUT LEVEL	-40dB to 0dB to +20dB (1dB Step)	Switch the 4W (intercom 2) input level.
4W OUTPUT LEVEL	-40dB to 0dB to +20dB (1dB Step)	Switch the 4W (intercom 2) output level.
RTS INPUT LEVEL	-40dB to 0dB to +20dB (1dB Step)	Switch the RTS (intercom 2) input level.
RTS OUTPUT LEVEL	-40dB to 0dB to +20dB (1dB Step)	Switch the RTS (intercom 2) output level.
RTS CANCEL LEVEL	-20.0dB to +20.0dB *1 (0.5dB Step)	Switch the RTS (intercom 2) I/O cancellation level.
CLRCOM INPUT LEVEL	-40dB to 0dB to +20dB (1dB Step)	Set the clear-com (intercom 2) input volume.
CLRCOM OUTPUT LEVEL	-40dB to 0dB to +20dB (1dB Step)	Set the clear-com (intercom 2) output volume.
CLRCOM CANCEL LEVEL	-20.0dB to +20.0dB *1 (0.5dB Step)	Adjust the clear-com (intercom 2) I/O cancellation signal level.
RTS/CLRCOM LOAD	ON OFF	Switch ON or OFF for the intercom 2 RTS/CLRCOM 200 Ω load.

*1: The default setting varies depending on adjustment at the factory.

PGM

This is the selection screen for the PGM menu.

```

->*** PGM ***

PGM1      GAIN: 0dB  LEVEL: 0dB
PGM2      GAIN: 0dB  LEVEL: 0dB
  
```

___ indicates factory default settings.

Item	Setting value	Setting details
PGM1 GAIN	0dB 20dB	Switch the PGM1 input gain.
PGM1 LEVEL	-40dB to 0dB to +20dB	Set the PGM1 input volume.
PGM2 GAIN	0dB 20dB	Switch the PGM2 input gain.
PGM2 LEVEL	-40dB to 0dB to +20dB	Set the PGM2 input volume.

MoIP FORMAT

This is the selection screen for the MoIP FORMAT menu.

```

->*** MoIP FORMAT ***

MIC1 TX           1ms/8ch
MIC2 TX           1ms/8ch
PGM1 RX           1ms/8ch
PGM2 RX           1ms/8ch
INCOM1 TX         1ms/8ch
INCOM2 TX         1ms/8ch
INCOM1 RX         1ms/8ch
INCOM2 RX         1ms/8ch
  
```

Item	Setting value	Setting details
MIC1 TX	[1ms/8ch] (fixed)	Sets the format for MIC1 output.
MIC2 TX	[1ms/8ch] (fixed)	Sets the format for MIC2 output.
PGM1 RX	[1ms/8ch] (fixed)	Sets the format for PGM1 input.
PGM2 RX	[1ms/8ch] (fixed)	Sets the format for PGM2 input.
INCOM1 TX	[1ms/8ch] (fixed)	Sets the format for INCOM1 output.
INCOM2 TX	[1ms/8ch] (fixed)	Sets the format for INCOM2 output.
INCOM1 RX	[1ms/8ch] (fixed)	Sets the format for INCOM1 input.
INCOM2 RX	[1ms/8ch] (fixed)	Sets the format for INCOM2 input.

NETWORK

This is the selection screen for the NETWORK menu.

```

->*** NETWORK ***
LAN
TALLY IN SETTING
PTP SETTING
ST2110 SETTING
SFP1(PRIMARY)
SFP1(PRIMARY)TX
SFP1(PRIMARY)RX
SFP2(SECONDARY)
SFP2(SECONDARY)TX
SFP2(SECONDARY)RX
NMOS SETTING
NDI/SRT SETTING
DNS SETTING

```

Item	Content	Details page
LAN	Display the LAN menu.	➔ "LAN" (see page 62)
TALLY IN SETTING	Display the TALLY IN SETTING menu.	➔ "TALLY IN SETTING" (see page 63)
PTP SETTING	Display the PTP SETTING menu. <ul style="list-style-type: none"> Can be set when the AK-NP701 option board is attached. 	➔ "PTP SETTING" (see page 64)
ST2110 SETTING	Display the ST2110 SETTING menu. <ul style="list-style-type: none"> Can be set when the AK-NP701 option board is attached. 	➔ "ST2110 SETTING" (see page 65)
SFP1(PRIMARY)	Display the SFP1(PRIMARY) menu. <ul style="list-style-type: none"> Can be set when the AK-NP701 option board is attached. 	➔ "SFP1(PRIMARY)" (see page 66)
SFP1(PRIMARY)TX	Display the SFP1(PRIMARY)TX menu. <ul style="list-style-type: none"> Can be set when the AK-NP701 option board is attached. 	➔ "SFP1(PRIMARY)TX" (see page 67)
SFP1(PRIMARY)RX	Display the SFP1(PRIMARY)RX menu. <ul style="list-style-type: none"> Can be set when the AK-NP701 option board is attached. 	➔ "SFP1(PRIMARY)RX" (see page 69)
SFP2(SECONDARY)	Display the SFP2(SECONDARY) menu. <ul style="list-style-type: none"> Can be set when the AK-NP701 option board is attached. 	➔ "SFP2(SECONDARY)" (see page 72)
SFP2(SECONDARY)TX	Display the SFP2(SECONDARY)TX menu. <ul style="list-style-type: none"> Can be set when the AK-NP701 option board is attached. 	➔ "SFP2(SECONDARY)TX" (see page 73)
SFP2(SECONDARY)RX	Display the SFP2(SECONDARY)RX menu. <ul style="list-style-type: none"> Can be set when the AK-NP701 option board is attached. 	➔ "SFP2(SECONDARY)RX" (see page 75)
NMOS SETTING	Display the NMOS SETTING menu. <ul style="list-style-type: none"> Can be set when the AK-NP701 option board is attached. 	➔ "NMOS SETTING" (see page 78)
NDI/SRT SETTING	Display the NDI/SRT SETTING menu. <ul style="list-style-type: none"> Can be set when the AK-NP703 option board is attached. 	➔ "NDI/SRT SETTING" (see page 79)
DNS SETTING	Display the DNS SETTING menu. <ul style="list-style-type: none"> Can be set when the AK-NP703 option board is attached. 	➔ "DNS SETTING" (see page 80)

LAN

This is the selection screen for the LAN menu.

- When [SET EXECUTE] is executed after making each of the settings, [NETWORK SET EXECUTE NO/YES] is displayed. Select "YES" to confirm the settings. If you close the menu without executing [SET EXECUTE], the modified content returns to the original settings.

<pre> ->*** LAN(1/2) *** DHCP OFF IP ADDRESS 192.168. 0. 20 SUBNETMASK 255.255.255. 0 DEFAULT GATEWAY 192.168. 0. 1 HTTP PORT 00080 ROP PORT 49152 MAC ADDRESS FF-FF-FF-FF-FF-FF </pre>	<pre> ->*** LAN(2/2) *** NTP SERVER ADDR 192.168. 0.123 PORT 123 TIME ADJUSTMENT INTERVAL 1h SET EXECUTE </pre>
---	--

The following information is required to configure network settings. Consult your network administrator or Internet service provider.

- IP address
- Port
- Subnet mask
- Default gateway (when using a gateway server or router)

___ indicates factory default settings.

Item	Setting value	Setting details
DHCP	ON <u>OFF</u>	Enables/disables DHCP.
IP ADDRESS	<u>192.168.0.20</u>	Set the IP address. <ul style="list-style-type: none"> Select and set each set of three digits with the cursor.
SUBNETMASK	<u>255.255.255.0</u>	Set the subnet mask.
DEFAULT GATEWAY	<u>192.168.0.1</u>	Set the default gateway.
HTTP PORT	00001 to 00080 to 65535 (20, 21, 23, 25, 42, 53, 67, 68, 69, 110, 123, 161, 162, 995, 10669, and 10670 are prohibited)	Set the port number used for web access.
ROP PORT	<u>49152</u> , 49200 to 49299	Set the port number used for connecting to the ROP.
MAC ADDRESS	Display only	Displays the MAC address.
NTP SERVER ADDR	1.0.0.1 to <u>192.168.0.123</u> to 223.255.255.254	Set the server for acquiring NTP.
NTP PORT	1 to <u>123</u> to 65535	Set the port number of the NTP server to be connected.
NTP TIME ADJUSTMENT INTERVAL	<u>1h</u> to 24h (1h Step)	Set the access interval for the NTP server.

TALLY IN SETTING

This is the selection screen for the TALLY IN SETTING menu.

- When [SET EXECUTE] is executed after making each of the settings, [NETWORK SET EXECUTE NO/YES] is displayed. Select "YES" to confirm the settings. If you close the menu without executing [SET EXECUTE], the modified content returns to the original settings.

```

->*** TALLY IN SETTING ***

INDEX No.                1
PORT                    62000

SET EXECUTE
  
```

___ indicates factory default settings.

Item	Setting value	Setting details
INDEX No.	<u>1</u> to 255	Sets the INDEX No. set by devices that output TALLY.
PORT	60000 to <u>62000</u> to 65535	Sets the PORT for TALLY IN.

NOTE

- The IP address for TALLY IN will be that of the settings for the [LAN] connector.

PTP SETTING

This is the selection screen for the PTP SETTING menu.

- Can be set when the AK-NP701 option board is attached.
- When [SET EXECUTE] is executed after making each of the settings, [NETWORK SET EXECUTE NO/YES] is displayed. Select "YES" to confirm the settings. If you close the menu without executing [SET EXECUTE], the modified content returns to the original settings.

```

->*** PTP SETTING ***

PRIMARY
CLOCK TYPE(PRM)          BC
IP ADDR(PRM)             0. 0. 0. 0
SECONDARY
CLOCK TYPE(SCD)          BC
IP ADDR(SCD)             0. 0. 0. 0
DOMAIN                   127
STATUS
GRANDMASTER ID
                        FF-FF-FF-FF-FF-FF-FF-FF
SET EXECUTE
  
```

___ indicates factory default settings.

Item	Setting value	Setting details
PRIMARY		
▶CLOCK TYPE(PRM)	<u>BC</u> E2E TC P2P TC	Sets the CLOCK TYPE for PTP(PRIMARY).
▶IP ADDR(PRM)	Display only	Displays the IP address for PTP(PRIMARY).
SECONDARY		
▶CLOCK TYPE(SCD)	<u>BC</u> E2E TC P2P TC	Sets the CLOCK TYPE for PTP(SECONDARY).
▶IP ADDR(SCD)	Display only	Displays the IP address for PTP(SECONDARY).
DOMAIN	1 to <u>127</u>	Sets the DOMAIN number.
STATUS		
▶GRANDMASTER ID	Display only	Displays the GRANDMASTER ID.

ST2110 SETTING

This is the selection screen for the ST2110 SETTING menu.

- Can be set when the AK-NP701 option board is attached.
- When [SET EXECUTE] is executed after making each of the settings, [NETWORK SET EXECUTE NO/YES] is displayed. Select "YES" to confirm the setting and the unit restarts. If you close the menu without executing [SET EXECUTE], the modified content returns to the original settings.

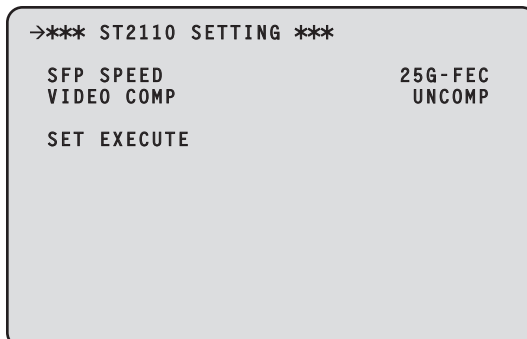

___ indicates factory default settings.

Item	Setting value	Setting details
SFP SPEED	<u>25G-FEC</u> 25G 10G	Make SFP module SPEED settings. <ul style="list-style-type: none"> • Use an SFP module that is compatible with the set SPEED.
VIDEO COMP	<u>UNCOMP</u> JPEG XS	Sets the images to be transmitted via ST2110.

SFP1(PRIMARY)

This is the selection screen for the SFP1(PRIMARY) menu.

- Can be set when the AK-NP701 option board is attached.
- When [SET EXECUTE] is executed after making each of the settings, [NETWORK SET EXECUTE NO/YES] is displayed. Select "YES" to confirm the settings. If you close the menu without executing [SET EXECUTE], the modified content returns to the original settings.

<pre> ->*** SFP1(PRIMARY)(1/2) *** MAIN DHCP OFF IP ADDRESS 192.168. 1. 50 PORT 49300 SUBNETMASK 255.255.255. 0 DEFAULT GATEWAY 192.168. 1. 1 MAC ADDRESS FF-FF-FF-FF-FF-FF SET EXECUTE </pre>	<pre> ->*** SFP1(PRIMARY)(2/2) *** TRANSCEIVER VENDER NAME VENDER PN VENDER REV VENDER SN DATA CODE TX POWER RX POWER </pre>
---	--

The following information is required to configure network settings. Consult your network administrator or Internet service provider.

- IP address
- Port
- Subnet mask
- Default gateway (when using a gateway server or router)

___ indicates factory default settings.

Item	Setting value	Setting details
MAIN		
▶DHCP	ON OFF	Enables/disables DHCP.
▶IP ADDRESS	192.168.1.50	Sets the IP address for SFP1(PRIMARY).
▶PORT	1024 to 49300 to 65535 (Setting 10670 is prohibited.)	Sets the PORT for SFP1(PRIMARY).
SUBNETMASK	255.255.255.0	Sets the subnet mask for SFP1(PRIMARY).
DEFAULT GATEWAY	192.168.1.1	Sets the default gateway for SFP1(PRIMARY).
MAC ADDRESS	Display only	Displays the MAC address for SFP1(PRIMARY).

Item	Display description
TRANSCEIVER	Displays the transceiver specifications for the SFP module.
VENDER NAME	Displays vendor information for the SFP module.
VENDER PN	Displays the part number code for the SFP module.
VENDER REV	Displays the revision code for the SFP module.
VENDER SN	Displays the serial number of the SFP module.
DATA CODE	Displays the data code for the SFP module.
TX POWER	Displays the strength of the light being output via the SFP module.
RX POWER	Displays the strength of the light being received by the SFP module.

SFP1(PRIMARY)TX

This is the selection screen for the SFP1(PRIMARY)TX menu.

- Can be set when the AK-NP701 option board is attached.
- When [SET EXECUTE] is executed after making each of the settings, [NETWORK SET EXECUTE NO/YES] is displayed. Select "YES" to confirm the settings. If you close the menu without executing [SET EXECUTE], the modified content returns to the original settings.

<p>→*** SFP1(PRM) TX(1/4) ***</p> <p>MAIN VIDEO TX IP ADDRESS 239. 1. 0. 1 PORT 49311</p> <p>JPEG XS TX IP ADDRESS 239. 1. 0. 10 PORT 49361</p> <p>MONITOR VIDEO TX IP ADDRESS 239. 1. 0. 11 PORT 49312</p> <p>SET EXECUTE</p>	<p>→*** SFP1(PRM) TX(2/4) ***</p> <p>HD TRUNK TX IP ADDRESS 239. 2. 0. 1 PORT 49321</p> <p>HD TRUNK AUDIO TX IP ADDRESS 239. 3. 0. 1 PORT 49331</p> <p>SET EXECUTE</p>
<p>→*** SFP1(PRM) TX(3/4) ***</p> <p>MIC1 AUDIO TX IP ADDRESS 239. 4. 0. 1 PORT 49341</p> <p>MIC2 AUDIO TX IP ADDRESS 239. 4. 0. 2 PORT 49342</p> <p>SET EXECUTE</p>	<p>→*** SFP1(PRM) TX(4/4) ***</p> <p>INCOM1 AUDIO TX IP ADDRESS 239. 5. 0. 1 PORT 49351</p> <p>INCOM2 AUDIO TX IP ADDRESS 239. 5. 0. 2 PORT 49352</p> <p>SET EXECUTE</p>

___ indicates factory default settings.

Item	Setting value	Setting details
MAIN VIDEO TX		
This is the setting for the main line output video.		
▶IP ADDRESS	<u>239.1.0.1</u>	Sets the IP address for MAIN VIDEO TX.
▶PORT	1024 to <u>49311</u> to 65535 (Setting 10670 is prohibited.)	Sets the PORT for MAIN VIDEO TX.
JPEG XS TX		
This is the setting for the JPEG XS.		
▶IP ADDRESS	<u>239.1.0.10</u>	Sets the IP address for JPEG XS TX.
▶PORT	1024 to <u>49361</u> to 65535 (Setting 10670 is prohibited.)	Sets the PORT for JPEG XS TX.
MONITOR VIDEO TX		
This is the setting for the monitor output video.		
▶IP ADDRESS	<u>239.1.0.11</u>	Sets the IP address for MONITOR VIDEO TX.
▶PORT	1024 to <u>49312</u> to 65535 (Setting 10670 is prohibited.)	Sets the PORT for MONITOR VIDEO TX.
HD TRUNK TX		
This is the setting for the HD TRUNK TX.		
▶IP ADDRESS	<u>239.2.0.1</u>	Sets the IP address for HD TRUNK TX.
▶PORT	1024 to <u>49321</u> to 65535 (Setting 10670 is prohibited.)	Sets the PORT for HD TRUNK TX.
HD TRUNK AUDIO TX		
This is the setting for the HD TRUNK AUDIO TX.		
▶IP ADDRESS	<u>239.3.0.1</u>	Sets the IP address for HD TRUNK AUDIO TX.
▶PORT	1024 to <u>49331</u> to 65535 (Setting 10670 is prohibited.)	Sets the PORT for HD TRUNK AUDIO TX.
MIC1 AUDIO TX		
This is the setting for the MIC1 output.		
▶IP ADDRESS	<u>239.4.0.1</u>	Sets the IP address for MIC1 AUDIO TX.
▶PORT	1024 to <u>49341</u> to 65535 (Setting 10670 is prohibited.)	Sets the PORT for MIC1 AUDIO TX.
MIC2 AUDIO TX		
This is the setting for the MIC2 output.		
▶IP ADDRESS	<u>239.4.0.2</u>	Sets the IP address for MIC2 AUDIO TX.
▶PORT	1024 to <u>49342</u> to 65535 (Setting 10670 is prohibited.)	Sets the PORT for MIC2 AUDIO TX.

Item	Setting value	Setting details
INCOM1 AUDIO TX		This is the setting for the INCOM1 output.
▶IP ADDRESS	<u>239.5.0.1</u>	Sets the IP address for INCOM1 AUDIO TX.
▶PORT	1024 to <u>49351</u> to 65535 (Setting 10670 is prohibited.)	Sets the PORT for INCOM1 AUDIO TX.
INCOM2 AUDIO TX		This is the setting for the INCOM2 output.
▶IP ADDRESS	<u>239.5.0.2</u>	Sets the IP address for INCOM2 AUDIO TX.
▶PORT	1024 to <u>49352</u> to 65535 (Setting 10670 is prohibited.)	Sets the PORT for INCOM2 AUDIO TX.

SFP1(PRIMARY)RX

This is the selection screen for the SFP1(PRIMARY)RX menu.

- Can be set when the AK-NP701 option board is attached.
- When [SET EXECUTE] is executed after making each of the settings, [NETWORK SET EXECUTE NO/YES] is displayed. Select "YES" to confirm the settings. If you close the menu without executing [SET EXECUTE], the modified content returns to the original settings.

<p>→*** SFP1(PRM) RX(1/7) ***</p> <pre> RET1 VIDEO RX MCAST ADDR 239. 11. 0. 1 SOURCE ADDR 0. 0. 0. 0 PORT 49411 RET2 VIDEO RX MCAST ADDR 239. 11. 0. 2 SOURCE ADDR 0. 0. 0. 0 PORT 49412 SET EXECUTE </pre>	<p>→*** SFP1(PRM) RX(2/7) ***</p> <pre> RET3 VIDEO RX MCAST ADDR 239. 11. 0. 3 SOURCE ADDR 0. 0. 0. 0 PORT 49413 RET4 VIDEO RX MCAST ADDR 239. 11. 0. 4 SOURCE ADDR 0. 0. 0. 0 PORT 49414 SET EXECUTE </pre>
<p>→*** SFP1(PRM) RX(3/7) ***</p> <pre> HD PROMPTER RX MCAST ADDR 239. 12. 0. 1 SOURCE ADDR 0. 0. 0. 0 PORT 49421 HD PROMPTER AUDIO RX MCAST ADDR 239. 13. 0. 1 SOURCE ADDR 0. 0. 0. 0 PORT 49431 SET EXECUTE </pre>	<p>→*** SFP1(PRM) RX(4/7) ***</p> <pre> PGM1 AUDIO RX MCAST ADDR 239. 14. 0. 1 SOURCE ADDR 0. 0. 0. 0 PORT 49441 PGM2 AUDIO RX MCAST ADDR 239. 14. 0. 2 SOURCE ADDR 0. 0. 0. 0 PORT 49442 SET EXECUTE </pre>
<p>→*** SFP1(PRM) RX(5/7) ***</p> <pre> INCOM1 AUDIO RX MCAST ADDR 239. 15. 0. 1 SOURCE ADDR 0. 0. 0. 0 PORT 49451 INCOM2 AUDIO RX MCAST ADDR 239. 15. 0. 2 SOURCE ADDR 0. 0. 0. 0 PORT 49452 SET EXECUTE </pre>	<p>→*** SFP1(PRM) RX(6/7) ***</p> <pre> RET1 JPEGS RX MCAST ADDR 239. 16. 0. 1 SOURCE ADDR 0. 0. 0. 0 PORT 49461 RET2 JPEGS RX MCAST ADDR 239. 16. 0. 2 SOURCE ADDR 0. 0. 0. 0 PORT 49462 SET EXECUTE </pre>
<p>→*** SFP1(PRM) RX(7/7) ***</p> <pre> RET3 JPEGS RX MCAST ADDR 239. 16. 0. 3 SOURCE ADDR 0. 0. 0. 0 PORT 49463 RET2 JPEGS RX MCAST ADDR 239. 16. 0. 4 SOURCE ADDR 0. 0. 0. 0 PORT 49464 SET EXECUTE </pre>	

___ indicates factory default settings.

Item	Setting value	Setting details
RET1 VIDEO RX		
▶MCAST ADDR	<u>239.11.0.1</u>	This is the setting for the return video input 1. Sets the multicast address for RET1 VIDEO RX.
▶SOURCE ADDR	<u>0.0.0.0</u>	Sets the transmission source IP address for RET1 VIDEO RX. <ul style="list-style-type: none"> • Set to 0.0.0.0 if no limitations on multicast source are to be implemented. • If you want to establish a source address, set the relevant address.
▶PORT	1024 to 49411 to 65535 (Setting 10670 is prohibited.)	Sets the PORT for RET1 VIDEO RX.

Item	Setting value	Setting details
RET2 VIDEO RX		This is the setting for the return video input 2.
▶MCAST ADDR	<u>239.11.0.2</u>	Sets the multicast address for RET2 VIDEO RX.
▶SOURCE ADDR	<u>0.0.0.0</u>	Sets the transmission source IP address for RET2 VIDEO RX. <ul style="list-style-type: none"> Set to 0.0.0.0 if no limitations on multicast source are to be implemented. If you want to establish a source address, set the relevant address.
▶PORT	1024 to 49412 to 65535 (Setting 10670 is prohibited.)	Sets the PORT for RET2 VIDEO RX.
RET3 VIDEO RX		This is the setting for the return video input 3.
▶MCAST ADDR	<u>239.11.0.3</u>	Sets the multicast address for RET3 VIDEO RX.
▶SOURCE ADDR	<u>0.0.0.0</u>	Sets the transmission source IP address for RET3 VIDEO RX. <ul style="list-style-type: none"> Set to 0.0.0.0 if no limitations on multicast source are to be implemented. If you want to establish a source address, set the relevant address.
▶PORT	1024 to 49413 to 65535 (Setting 10670 is prohibited.)	Sets the PORT for RET3 VIDEO RX.
RET4 VIDEO RX		This is the setting for the return video input 4.
▶MCAST ADDR	<u>239.11.0.4</u>	Sets the multicast address for RET4 VIDEO RX.
▶SOURCE ADDR	<u>0.0.0.0</u>	Sets the transmission source IP address for RET4 VIDEO RX. <ul style="list-style-type: none"> Set to 0.0.0.0 if no limitations on multicast source are to be implemented. If you want to establish a source address, set the relevant address.
▶PORT	1024 to 49414 to 65535 (Setting 10670 is prohibited.)	Sets the PORT for RET4 VIDEO RX.
HD PROMPTER RX		This is the setting for the HD PROMPTER input.
▶MCAST ADDR	<u>239.12.0.1</u>	Sets the multicast address for HD PROMPTER RX.
▶SOURCE ADDR	<u>0.0.0.0</u>	Sets the transmission source IP address for HD PROMPTER RX. <ul style="list-style-type: none"> Set to 0.0.0.0 if no limitations on multicast source are to be implemented. If you want to establish a source address, set the relevant address.
▶PORT	1024 to 49421 to 65535 (Setting 10670 is prohibited.)	Sets the PORT for HD PROMPTER RX.
HD PROMPTER AUDIO RX		Sets the HD PROMPTER input audio.
▶MCAST ADDR	<u>239.13.0.1</u>	Sets the multicast address for HD PROMPTER AUDIO RX.
▶SOURCE ADDR	<u>0.0.0.0</u>	Sets the transmission source IP address for HD PROMPTER AUDIO RX. <ul style="list-style-type: none"> Set to 0.0.0.0 if no limitations on multicast source are to be implemented. If you want to establish a source address, set the relevant address.
▶PORT	1024 to 49431 to 65535 (Setting 10670 is prohibited.)	Sets the PORT for HD PROMPTER AUDIO RX.
PGM1 AUDIO RX		This is the setting for the PGM1 input.
▶MCAST ADDR	<u>239.14.0.1</u>	Sets the multicast address for PGM1 AUDIO RX.
▶SOURCE ADDR	<u>0.0.0.0</u>	Sets the transmission source IP address for PGM1 AUDIO RX. <ul style="list-style-type: none"> Set to 0.0.0.0 if no limitations on multicast source are to be implemented. If you want to establish a source address, set the relevant address.
▶PORT	1024 to 49441 to 65535 (Setting 10670 is prohibited.)	Sets the PORT for PGM1 AUDIO RX.
PGM2 AUDIO RX		This is the setting for the PGM2 input.
▶MCAST ADDR	<u>239.14.0.2</u>	Sets the multicast address for PGM2 AUDIO RX.
▶SOURCE ADDR	<u>0.0.0.0</u>	Sets the transmission source IP address for PGM2 AUDIO RX. <ul style="list-style-type: none"> Set to 0.0.0.0 if no limitations on multicast source are to be implemented. If you want to establish a source address, set the relevant address.
▶PORT	1024 to 49442 to 65535 (Setting 10670 is prohibited.)	Sets the PORT for PGM2 AUDIO RX.

Item	Setting value	Setting details
INCOM1 AUDIO RX		This is the setting for the INCOM1 input.
▶MCAST ADDR	<u>239.15.0.1</u>	Sets the multicast address for INCOM1 AUDIO RX.
▶SOURCE ADDR	<u>0.0.0.0</u>	Sets the transmission source IP address for INCOM1 AUDIO RX. <ul style="list-style-type: none"> Set to 0.0.0.0 if no limitations on multicast source are to be implemented. If you want to establish a source address, set the relevant address.
▶PORT	1024 to 49451 to 65535 (Setting 10670 is prohibited.)	Sets the PORT for INCOM1 AUDIO RX.
INCOM2 AUDIO RX		This is the setting for the INCOM2 input.
▶MCAST ADDR	<u>239.15.0.2</u>	Sets the multicast address for INCOM2 AUDIO RX.
▶SOURCE ADDR	<u>0.0.0.0</u>	Sets the transmission source IP address for INCOM2 AUDIO RX. <ul style="list-style-type: none"> Set to 0.0.0.0 if no limitations on multicast source are to be implemented. If you want to establish a source address, set the relevant address.
▶PORT	1024 to 49452 to 65535 (Setting 10670 is prohibited.)	Sets the PORT for INCOM2 AUDIO RX.
RET1 JPEG XS RX		Sets return JPEG XS image input 1.
▶MCAST ADDR	<u>239.16.0.1</u>	Sets the multicast address for RET1 JPEG XS RX.
▶SOURCE ADDR	<u>0.0.0.0</u>	Sets the transmission source IP address for RET1 JPEG XS RX. <ul style="list-style-type: none"> Set to 0.0.0.0 if no limitations on multicast source are to be implemented. If you want to establish a source address, set the relevant address.
▶PORT	1024 to 49461 to 65535 (Setting 10670 is prohibited.)	Sets the PORT for RET1 JPEG XS RX.
RET2 JPEG XS RX		Sets return JPEG XS image input 2.
▶MCAST ADDR	<u>239.16.0.2</u>	Sets the multicast address for RET2 JPEG XS RX.
▶SOURCE ADDR	<u>0.0.0.0</u>	Sets the transmission source IP address for RET2 JPEG XS RX. <ul style="list-style-type: none"> Set to 0.0.0.0 if no limitations on multicast source are to be implemented. If you want to establish a source address, set the relevant address.
▶PORT	1024 to 49462 to 65535 (Setting 10670 is prohibited.)	Sets the PORT for RET2 JPEG XS RX.
RET3 JPEG XS RX		Sets return JPEG XS image input 3.
▶MCAST ADDR	<u>239.16.0.3</u>	Sets the multicast address for RET3 JPEG XS RX.
▶SOURCE ADDR	<u>0.0.0.0</u>	Sets the transmission source IP address for RET3 JPEG XS RX. <ul style="list-style-type: none"> Set to 0.0.0.0 if no limitations on multicast source are to be implemented. If you want to establish a source address, set the relevant address.
▶PORT	1024 to 49463 to 65535 (Setting 10670 is prohibited.)	Sets the PORT for RET3 JPEG XS RX.
RET4 JPEG XS RX		Sets return JPEG XS image input 4.
▶MCAST ADDR	<u>239.16.0.4</u>	Sets the multicast address for RET4 JPEG XS RX.
▶SOURCE ADDR	<u>0.0.0.0</u>	Sets the transmission source IP address for RET4 JPEG XS RX. <ul style="list-style-type: none"> Set to 0.0.0.0 if no limitations on multicast source are to be implemented. If you want to establish a source address, set the relevant address.
▶PORT	1024 to 49464 to 65535 (Setting 10670 is prohibited.)	Sets the PORT for RET4 JPEG XS RX.

SFP2(SECONDARY)

This is the selection screen for the SFP2(SECONDARY) menu.

- Can be set when the AK-NP701 option board is attached.
- When [SET EXECUTE] is executed after making each of the settings, [NETWORK SET EXECUTE NO/YES] is displayed. Select "YES" to confirm the settings. If you close the menu without executing [SET EXECUTE], the modified content returns to the original settings.

<pre> ->*** SFP2(SECONDARY)(1/2) *** MAIN DHCP OFF IP ADDRESS 192.168. 0. 51 PORT 49301 SUBNETMASK 255.255.255. 0 DEFAULT GATEWAY 192.168. 0. 1 MAC ADDRESS FF-FF-FF-FF-FF-FF SET EXECUTE </pre>	<pre> ->*** SFP2(SECONDARY)(2/2) *** TRANSCEIVER VENDER NAME VENDER PN VENDER REV VENDER SN DATA CODE TX POWER RX POWER </pre>
---	--

The following information is required to configure network settings. Consult your network administrator or Internet service provider.

- IP address
- Port
- Subnet mask
- Default gateway (when using a gateway server or router)

___ indicates factory default settings.

Item	Setting value	Setting details
MAIN		
▶DHCP	ON OFF	Enables/disables DHCP.
▶IP ADDRESS	<u>192.168.0.51</u>	Sets the IP address for SFP2(SECONDARY).
▶PORT	1024 to <u>49301</u> to 65535 (Setting 10670 is prohibited.)	Sets the PORT for SFP2(SECONDARY).
SUBNETMASK	<u>255.255.255.0</u>	Sets the subnet mask for SFP2(SECONDARY).
DEFAULT GATEWAY	<u>192.168.0.1</u>	Sets the default gateway for SFP2(SECONDARY).
MAC ADDRESS	Display only	Displays the MAC address for SFP2(SECONDARY).

Item	Display description
TRANSCEIVER	Displays the transceiver specifications for the SFP module.
VENDER NAME	Displays vendor information for the SFP module.
VENDER PN	Displays the part number code for the SFP module.
VENDER REV	Displays the revision code for the SFP module.
VENDER SN	Displays the serial number of the SFP module.
DATA CODE	Displays the data code for the SFP module.
TX POWER	Displays the strength of the light being output via the SFP module.
RX POWER	Displays the strength of the light being received by the SFP module.

SFP2(SECONDARY)TX

This is the selection screen for the SFP2(SECONDARY)TX menu.

- Can be set when the AK-NP701 option board is attached.
- When [SET EXECUTE] is executed after making each of the settings, [NETWORK SET EXECUTE NO/YES] is displayed. Select "YES" to confirm the settings. If you close the menu without executing [SET EXECUTE], the modified content returns to the original settings.

<p>→*** SFP2(SCD) TX(1/4) ***</p> <p>MAIN VIDEO TX IP ADDRESS 239. 21. 0. 1 PORT 49511</p> <p>JPEG XS TX IP ADDRESS 239. 21. 0. 10 PORT 49561</p> <p>MONITOR VIDEO TX IP ADDRESS 239. 21. 0. 11 PORT 49512</p> <p>SET EXECUTE</p>	<p>→*** SFP2(SCD) TX(2/4) ***</p> <p>HD TRUNK TX IP ADDRESS 239. 22. 0. 1 PORT 49521</p> <p>HD TRUNK AUDIO TX IP ADDRESS 239. 23. 0. 1 PORT 49531</p> <p>SET EXECUTE</p>
<p>→*** SFP2(SCD) TX(3/4) ***</p> <p>MIC1 AUDIO TX IP ADDRESS 239. 24. 0. 1 PORT 49541</p> <p>MIC2 AUDIO TX IP ADDRESS 239. 24. 0. 2 PORT 49542</p> <p>SET EXECUTE</p>	<p>→*** SFP2(SCD) TX(4/4) ***</p> <p>INCOM1 AUDIO TX IP ADDRESS 239. 25. 0. 1 PORT 49551</p> <p>INCOM2 AUDIO TX IP ADDRESS 239. 25. 0. 2 PORT 49552</p> <p>SET EXECUTE</p>

___ indicates factory default settings.

Item	Setting value	Setting details
MAIN VIDEO TX		
This is the setting for the main line output video.		
▶IP ADDRESS	<u>239.21.0.1</u>	Sets the IP address for MAIN VIDEO TX.
▶PORT	1024 to <u>49511</u> to 65535 (Setting 10670 is prohibited.)	Sets the PORT for MAIN VIDEO TX.
JPEG XS TX		
This is the setting for the JPEG XS.		
▶IP ADDRESS	<u>239.21.0.10</u>	Sets the IP address for JPEG XS TX.
▶PORT	1024 to <u>49561</u> to 65535 (Setting 10670 is prohibited.)	Sets the PORT for JPEG XS TX.
MONITOR VIDEO TX		
This is the setting for the monitor output video.		
▶IP ADDRESS	<u>239.21.0.11</u>	Sets the IP address for MONITOR VIDEO TX.
▶PORT	1024 to <u>49512</u> to 65535 (Setting 10670 is prohibited.)	Sets the PORT for MONITOR VIDEO TX.
HD TRUNK TX		
This is the setting for the HD TRUNK TX.		
▶IP ADDRESS	<u>239.22.0.1</u>	Sets the IP address for HD TRUNK TX.
▶PORT	1024 to <u>49521</u> to 65535 (Setting 10670 is prohibited.)	Sets the PORT for HD TRUNK TX.
HD TRUNK AUDIO TX		
This is the setting for the HD TRUNK AUDIO TX.		
▶IP ADDRESS	<u>239.23.0.1</u>	Sets the IP address for HD TRUNK AUDIO TX.
▶PORT	1024 to <u>49531</u> to 65535 (Setting 10670 is prohibited.)	Sets the PORT for HD TRUNK AUDIO TX.
MIC1 AUDIO TX		
This is the setting for the MIC1 output.		
▶IP ADDRESS	<u>239.24.0.1</u>	Sets the IP address for MIC1 AUDIO TX.
▶PORT	1024 to <u>49541</u> to 65535 (Setting 10670 is prohibited.)	Sets the PORT for MIC1 AUDIO TX.
MIC2 AUDIO TX		
This is the setting for the MIC2 output.		
▶IP ADDRESS	<u>239.24.0.2</u>	Sets the IP address for MIC2 AUDIO TX.
▶PORT	1024 to <u>49542</u> to 65535 (Setting 10670 is prohibited.)	Sets the PORT for MIC2 AUDIO TX.

Item	Setting value	Setting details
INCOM1 AUDIO TX		This is the setting for the INCOM1 output.
▶IP ADDRESS	<u>239.25.0.1</u>	Sets the IP address for INCOM1 AUDIO TX.
▶PORT	1024 to <u>49551</u> to 65535 (Setting 10670 is prohibited.)	Sets the PORT for INCOM1 AUDIO TX.
INCOM2 AUDIO TX		This is the setting for the INCOM2 output.
▶IP ADDRESS	<u>239.25.0.2</u>	Sets the IP address for INCOM2 AUDIO TX.
▶PORT	1024 to <u>49552</u> to 65535 (Setting 10670 is prohibited.)	Sets the PORT for INCOM2 AUDIO TX.

SFP2(SECONDARY)RX

This is the selection screen for the SFP2(SECONDARY)RX menu.

- Can be set when the AK-NP701 option board is attached.
- When [SET EXECUTE] is executed after making each of the settings, [NETWORK SET EXECUTE NO/YES] is displayed. Select "YES" to confirm the settings. If you close the menu without executing [SET EXECUTE], the modified content returns to the original settings.

<p>→*** SFP2(SCD) RX(1/7) ***</p> <pre> RET1 VIDEO RX MCAST ADDR 239. 31. 0. 1 SOURCE ADDR 0. 0. 0. 0 PORT 49611 RET2 VIDEO RX MCAST ADDR 239. 31. 0. 2 SOURCE ADDR 0. 0. 0. 0 PORT 49612 SET EXECUTE </pre>	<p>→*** SFP2(SCD) RX(2/7) ***</p> <pre> RET3 VIDEO RX MCAST ADDR 239. 31. 0. 3 SOURCE ADDR 0. 0. 0. 0 PORT 49613 RET4 VIDEO RX MCAST ADDR 239. 31. 0. 4 SOURCE ADDR 0. 0. 0. 0 PORT 49614 SET EXECUTE </pre>
<p>→*** SFP2(SCD) RX(3/7) ***</p> <pre> HD PROMPTER RX MCAST ADDR 239. 32. 0. 1 SOURCE ADDR 0. 0. 0. 0 PORT 49621 HD PROMPTER AUDIO RX MCAST ADDR 239. 33. 0. 1 SOURCE ADDR 0. 0. 0. 0 PORT 49631 SET EXECUTE </pre>	<p>→*** SFP2(SCD) RX(4/7) ***</p> <pre> PGM1 AUDIO RX MCAST ADDR 239. 34. 0. 1 SOURCE ADDR 0. 0. 0. 0 PORT 49641 PGM2 AUDIO RX MCAST ADDR 239. 34. 0. 2 SOURCE ADDR 0. 0. 0. 0 PORT 49642 SET EXECUTE </pre>
<p>→*** SFP2(SCD) RX(5/7) ***</p> <pre> INCOM1 AUDIO RX MCAST ADDR 239. 35. 0. 1 SOURCE ADDR 0. 0. 0. 0 PORT 49651 INCOM2 AUDIO RX MCAST ADDR 239. 35. 0. 2 SOURCE ADDR 0. 0. 0. 0 PORT 49652 SET EXECUTE </pre>	<p>→*** SFP2(SCD) RX(6/7) ***</p> <pre> RET1 JPEG XS RX MCAST ADDR 239. 36. 0. 1 SOURCE ADDR 0. 0. 0. 0 PORT 49661 RET2 JPEG XS RX MCAST ADDR 239. 36. 0. 2 SOURCE ADDR 0. 0. 0. 0 PORT 49662 SET EXECUTE </pre>
<p>→*** SFP2(SCD) RX(7/7) ***</p> <pre> RET3 JPEG XS RX MCAST ADDR 239. 36. 0. 3 SOURCE ADDR 0. 0. 0. 0 PORT 49663 RET4 JPEG XS RX MCAST ADDR 239. 36. 0. 4 SOURCE ADDR 0. 0. 0. 0 PORT 49664 SET EXECUTE </pre>	

___ indicates factory default settings.

Item	Setting value	Setting details
RET1 VIDEO RX		
▶MCAST ADDR	<u>239.31.0.1</u>	This is the setting for the return video input 1. Sets the multicast address for RET1 VIDEO RX.
▶SOURCE ADDR	<u>0.0.0.0</u>	Sets the transmission source IP address for RET1 VIDEO RX. <ul style="list-style-type: none"> • Set to 0.0.0.0 if no limitations on multicast source are to be implemented. • If you want to establish a source address, set the relevant address.
▶PORT	1024 to 49611 to 65535 (Setting 10670 is prohibited.)	Sets the PORT for RET1 VIDEO RX.

Item	Setting value	Setting details
RET2 VIDEO RX		This is the setting for the return video input 2.
▶MCAST ADDR	<u>239.31.0.2</u>	Sets the multicast address for RET2 VIDEO RX.
▶SOURCE ADDR	<u>0.0.0.0</u>	Sets the transmission source IP address for RET2 VIDEO RX. <ul style="list-style-type: none"> Set to 0.0.0.0 if no limitations on multicast source are to be implemented. If you want to establish a source address, set the relevant address.
▶PORT	1024 to 49612 to 65535 (Setting 10670 is prohibited.)	Sets the PORT for RET2 VIDEO RX.
RET3 VIDEO RX		This is the setting for the return video input 3.
▶MCAST ADDR	<u>239.31.0.3</u>	Sets the multicast address for RET3 VIDEO RX.
▶SOURCE ADDR	<u>0.0.0.0</u>	Sets the transmission source IP address for RET3 VIDEO RX. <ul style="list-style-type: none"> Set to 0.0.0.0 if no limitations on multicast source are to be implemented. If you want to establish a source address, set the relevant address.
▶PORT	1024 to 49613 to 65535 (Setting 10670 is prohibited.)	Sets the PORT for RET3 VIDEO RX.
RET4 VIDEO RX		This is the setting for the return video input 4.
▶MCAST ADDR	<u>239.31.0.4</u>	Sets the multicast address for RET4 VIDEO RX.
▶SOURCE ADDR	<u>0.0.0.0</u>	Sets the transmission source IP address for RET4 VIDEO RX. <ul style="list-style-type: none"> Set to 0.0.0.0 if no limitations on multicast source are to be implemented. If you want to establish a source address, set the relevant address.
▶PORT	1024 to 49614 to 65535 (Setting 10670 is prohibited.)	Sets the PORT for RET4 VIDEO RX.
HD PROMPTER RX		This is the setting for the HD PROMPTER input.
▶MCAST ADDR	<u>239.32.0.1</u>	Sets the multicast address for HD PROMPTER RX.
▶SOURCE ADDR	<u>0.0.0.0</u>	Sets the transmission source IP address for HD PROMPTER RX. <ul style="list-style-type: none"> Set to 0.0.0.0 if no limitations on multicast source are to be implemented. If you want to establish a source address, set the relevant address.
▶PORT	1024 to 49621 to 65535 (Setting 10670 is prohibited.)	Sets the PORT for HD PROMPTER RX.
HD PROMPTER AUDIO RX		Sets the HD PROMPTER input audio.
▶MCAST ADDR	<u>239.33.0.1</u>	Sets the multicast address for HD PROMPTER AUDIO RX.
▶SOURCE ADDR	<u>0.0.0.0</u>	Sets the transmission source IP address for HD PROMPTER AUDIO RX. <ul style="list-style-type: none"> Set to 0.0.0.0 if no limitations on multicast source are to be implemented. If you want to establish a source address, set the relevant address.
▶PORT	1024 to 49631 to 65535 (Setting 10670 is prohibited.)	Sets the PORT for HD PROMPTER AUDIO RX.
PGM1 AUDIO RX		This is the setting for the PGM1 input.
▶MCAST ADDR	<u>239.34.0.1</u>	Sets the multicast address for PGM1 AUDIO RX.
▶SOURCE ADDR	<u>0.0.0.0</u>	Sets the transmission source IP address for PGM1 AUDIO RX. <ul style="list-style-type: none"> Set to 0.0.0.0 if no limitations on multicast source are to be implemented. If you want to establish a source address, set the relevant address.
▶PORT	1024 to 49641 to 65535 (Setting 10670 is prohibited.)	Sets the PORT for PGM1 AUDIO RX.
PGM2 AUDIO RX		This is the setting for the PGM2 input.
▶MCAST ADDR	<u>239.34.0.2</u>	Sets the multicast address for PGM2 AUDIO RX.
▶SOURCE ADDR	<u>0.0.0.0</u>	Sets the transmission source IP address for PGM2 AUDIO RX. <ul style="list-style-type: none"> Set to 0.0.0.0 if no limitations on multicast source are to be implemented. If you want to establish a source address, set the relevant address.
▶PORT	1024 to 49642 to 65535 (Setting 10670 is prohibited.)	Sets the PORT for PGM2 AUDIO RX.

Item	Setting value	Setting details
INCOM1 AUDIO RX		This is the setting for the INCOM1 input.
▶MCAST ADDR	<u>239.35.0.1</u>	Sets the multicast address for INCOM1 AUDIO RX.
▶SOURCE ADDR	<u>0.0.0.0</u>	Sets the transmission source IP address for INCOM1 AUDIO RX. <ul style="list-style-type: none"> Set to 0.0.0.0 if no limitations on multicast source are to be implemented. If you want to establish a source address, set the relevant address.
▶PORT	1024 to 49651 to 65535 (Setting 10670 is prohibited.)	Sets the PORT for INCOM1 AUDIO RX.
INCOM2 AUDIO RX		This is the setting for the INCOM2 input.
▶MCAST ADDR	<u>239.35.0.2</u>	Sets the multicast address for INCOM2 AUDIO RX.
▶SOURCE ADDR	<u>0.0.0.0</u>	Sets the transmission source IP address for INCOM2 AUDIO RX. <ul style="list-style-type: none"> Set to 0.0.0.0 if no limitations on multicast source are to be implemented. If you want to establish a source address, set the relevant address.
▶PORT	1024 to 49652 to 65535 (Setting 10670 is prohibited.)	Sets the PORT for INCOM2 AUDIO RX.
RET1 JPEG XS RX		Sets return JPEG XS image input 1.
▶MCAST ADDR	<u>239.36.0.1</u>	Sets the multicast address for RET1 JPEG XS RX.
▶SOURCE ADDR	<u>0.0.0.0</u>	Sets the transmission source IP address for RET1 JPEG XS RX. <ul style="list-style-type: none"> Set to 0.0.0.0 if no limitations on multicast source are to be implemented. If you want to establish a source address, set the relevant address.
▶PORT	1024 to 49661 to 65535 (Setting 10670 is prohibited.)	Sets the PORT for RET1 JPEG XS RX.
RET2 JPEG XS RX		Sets return JPEG XS image input 2.
▶MCAST ADDR	<u>239.36.0.2</u>	Sets the multicast address for RET2 JPEG XS RX.
▶SOURCE ADDR	<u>0.0.0.0</u>	Sets the transmission source IP address for RET2 JPEG XS RX. <ul style="list-style-type: none"> Set to 0.0.0.0 if no limitations on multicast source are to be implemented. If you want to establish a source address, set the relevant address.
▶PORT	1024 to 49662 to 65535 (Setting 10670 is prohibited.)	Sets the PORT for RET2 JPEG XS RX.
RET3 JPEG XS RX		Sets return JPEG XS image input 3.
▶MCAST ADDR	<u>239.36.0.3</u>	Sets the multicast address for RET3 JPEG XS RX.
▶SOURCE ADDR	<u>0.0.0.0</u>	Sets the transmission source IP address for RET3 JPEG XS RX. <ul style="list-style-type: none"> Set to 0.0.0.0 if no limitations on multicast source are to be implemented. If you want to establish a source address, set the relevant address.
▶PORT	1024 to 49663 to 65535 (Setting 10670 is prohibited.)	Sets the PORT for RET3 JPEG XS RX.
RET4 JPEG XS RX		Sets return JPEG XS image input 4.
▶MCAST ADDR	<u>239.36.0.4</u>	Sets the multicast address for RET4 JPEG XS RX.
▶SOURCE ADDR	<u>0.0.0.0</u>	Sets the transmission source IP address for RET4 JPEG XS RX. <ul style="list-style-type: none"> Set to 0.0.0.0 if no limitations on multicast source are to be implemented. If you want to establish a source address, set the relevant address.
▶PORT	1024 to 49664 to 65535 (Setting 10670 is prohibited.)	Sets the PORT for RET4 JPEG XS RX.

NMOS SETTING

This is the selection screen for the NMOS SETTING menu.

- Can be set when the AK-NP701 option board is attached.
- When [SET EXECUTE] is executed after making each of the settings, [NETWORK SET EXECUTE NO/YES] is displayed. Select "YES" to confirm the settings. If you close the menu without executing [SET EXECUTE], the modified content returns to the original settings.

```

->*** NMOS SETTING ***

NMOS CONTROL          ON
STATUS                UNREGISTERED
PORT(IS-04)          50040
PORT(IS-05)          50050
RDS IP ADDR          ---.---.---.---
RDS PORT             -----
LABEL SETTING        AUTO
LABEL PREFIX         UCU700_XXXX
DISCOVERY            uniDNS

SET EXECUTE
  
```

___ indicates factory default settings.

Item	Setting value	Setting details
NMOS CONTROL	<u>ON</u> OFF	Enables/disables the NMOS function.
STATUS	UNREGISTERED REGISTERING REGISTERED P2P MODE --- (Display only)	Displays the NMOS operation status, such as RDS connection status.
PORT(IS-04)	1024 to <u>50040</u> to 65535	Sets the port number on the camera for IS-04 Node API.
PORT(IS-05)	1024 to <u>50050</u> to 65535	Sets the port number on the camera for IS-05 Connection API.
RDS IP ADDR	Display only	Displays the IP address automatically discovered.
RDS PORT	Display only	Displays the port number automatically discovered.
LABEL SETTING	<u>AUTO</u> MANUAL	AUTO: It is fixed to UCU700_**** ("*****" is the last four digits of the MAC address). MANUAL: Text can be set in LABEL PREFIX.
LABEL PREFIX	Maximum 16 characters (alphanumeric characters, spaces, ! # % () + , - . / = [] _) (Factory setting: UCU700_**** ("*****" is the last four digits of the MAC address))	Sets the prefix appended which is shared with NMOS resource names on this unit.
DISCOVERY	<u>uniDNS</u> mDNS	Sets the method for NMOS resource discovery.

NDI/SRT SETTING

This is the selection screen for the NDI/SRT SETTING menu.

- Can be set when the AK-NP703 option board is attached.
- When [SET EXECUTE] is executed after making each of the settings, [NETWORK SET EXECUTE NO/YES] is displayed. Select "YES" to confirm the settings. If you close the menu without executing [SET EXECUTE], the modified content returns to the original settings.

```

->*** NDI/SRT SETTING ***

DHCP                                OFF
IP ADDR                            192.168.  0. 52
PORT                                49302
SUBNETMASK                          255.255.255.  0
DEFAULT GATEWAY                     192.168.  0.  1
MAC ADDRESS                          FF-FF-FF-FF-FF-FF

SET EXECUTE

```

The following information is required to configure network settings. Consult your network administrator or Internet service provider.

- IP address
- Port
- Subnet mask
- Default gateway (when using a gateway server or router)

___ indicates factory default settings.

Item	Setting value	Setting details
DHCP	ON OFF	Enables/disables DHCP.
IP ADDR	<u>192.168.0.52</u>	Sets the IP address for NDI/SRT.
PORT	1024 to <u>49302</u> to 65535 (Setting 10670 is prohibited.)	Sets the PORT for NDI/SRT.
SUBNETMASK	<u>255.255.255.0</u>	Sets the subnet mask for NDI/SRT.
DEFAULT GATEWAY	<u>192.168.0.1</u>	Sets the default gateway for NDI/SRT.
MAC ADDRESS	Display only	Displays the MAC address for NDI/SRT.

DNS SETTING

This is the selection screen for the DNS SETTING menu.

- Can be set when the AK-NP703 option board is attached.
- When [SET EXECUTE] is executed after making each of the settings, [NETWORK SET EXECUTE NO/YES] is displayed. Select "YES" to confirm the settings. If you close the menu without executing [SET EXECUTE], the modified content returns to the original settings.

```

->*** DNS SETTING ***

DNS                MANUAL
PRIMARY           0.  0.  0.  0
SECONDARY        0.  0.  0.  0
DOMAIN

SET EXECUTE
  
```

The following information is required to configure network settings. Consult your network administrator or Internet service provider.

- Primary server address, secondary server address, and domain for DNS (when using DNS)

___ indicates factory default settings.

Item	Setting value	Setting details
DNS	AUTO MANUAL	Sets the method for acquiring the address for the DNS Server.
▶PRIMARY	0.0.0.0	Sets the DNS PRIMARY address.
▶SECONDARY	0.0.0.0	Sets the DNS SECONDARY address.
▶DOMAIN	Display only	The value allocated by the DHCP server is displayed.

MAINTENANCE

This is the selection screen for the MAINTENANCE menu.

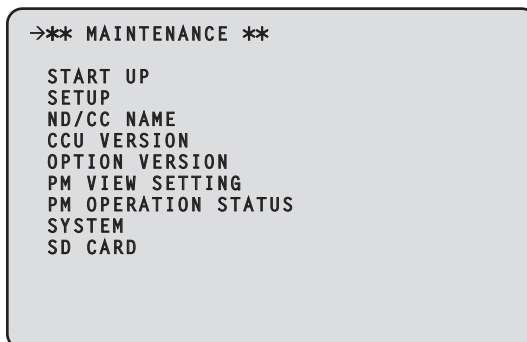

Item	Content	Details page
START UP	Display the START UP menu.	➔ "START UP" (see page 82)
SETUP	Display the SETUP menu.	➔ "SETUP" (see page 82)
ND/CC NAME*1	Display the ND/CC NAME menu.	➔ "ND/CC NAME" (see page 84)
CCU VERSION	Display the CCU VERSION menu.	➔ "CCU VERSION" (see page 85)
OPTION VERSION	Display the OPTION VERSION menu.	➔ "OPTION VERSION" (see page 85)
PM VIEW SETTING	Display the PM VIEW SETTING menu.	➔ "PM VIEW SETTING" (see page 86)
PM OPERATION STATUS	Display the PM OPERATION STATUS menu.	➔ "PM OPERATION STATUS" (see page 87)
SYSTEM*2	Display the SYSTEM menu.	➔ "SYSTEM" (see page 88)
SD CARD*2	Display the SD CARD menu.	➔ "SD CARD" (see page 90)

*1: Displayed as "ND NAME" when AK-UC3300 and AK-PLV100 are connected.

*2: Cannot be selected until unit startup is complete (i.e., about 1 minute after turning the power on).

START UP

This is the selection screen for the START UP menu.

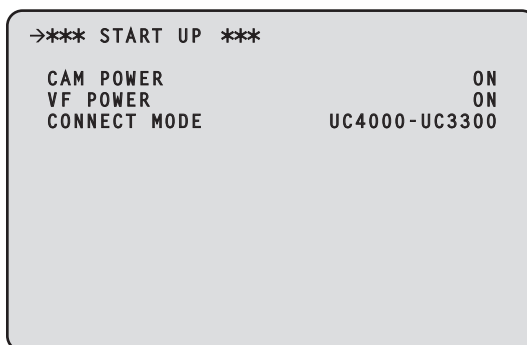

___ indicates factory default settings.

Item	Setting value	Setting details
CAM POWER	OFF <u>ON</u> REMOTE	Set the control of the camera's power that is to be performed when the unit's power is turned on. OFF The camera's power will not come on even when the unit's power is turned on. In this case, "HEAD POWER" on the operation panel of the ROP or [CAMERA POWER] on the unit must be set to ON. ON The camera's power will come on when the unit's power is turned on. REMOTE Turns on in the same state as when the CCU power was turned OFF.
VF POWER	OFF <u>ON</u> REMOTE	Set the control of the viewfinder's power that is performed when the unit's power is turned on. OFF The viewfinder's power will not come on even when the unit's power is turned on. In this case, "VF POWER" must be set to ON on the operation panel of the ROP. ON Turning on the power of this unit also turns on the power of the viewfinder. REMOTE Turns on in the same state as when the CCU power was turned OFF.
CONNECT MODE	<u>UC4000-UC3300</u> PLV100	Set the unit to connect to AK-UC4000, AK-UC3300, or AK-PLV100 when turning on the power of this unit. UC4000-UC3300 Connect to the AK-UC4000 or AK-UC3300. PLV100 Connect to the AK-PLV100.

SETUP

This is the selection screen for the SETUP menu.

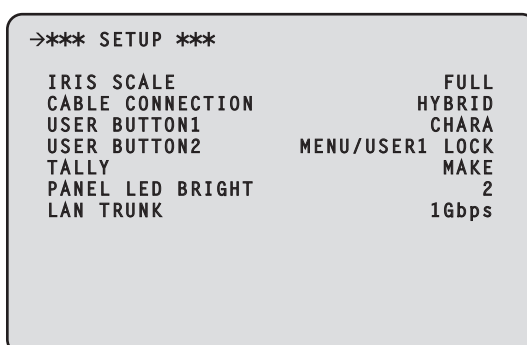

___ indicates factory default settings.

Item	Setting value	Setting details
IRIS SCALE	<u>FULL</u> 2STOP	Set the IRIS display range of the status display screen.

Item	Setting value	Setting details
CABLE CONNECTION	<u>HYBRID</u> FIBER	Sets the cable used to connect the camera. HYBRID Select this when connecting the camera using an optical fiber multi cable. FIBER Select this when connecting the camera using only optical fiber. When [FIBER] is selected, power will not be supplied to the camera. In addition, the "OPEN" and "SHORT" errors will not be displayed.
USER BUTTON1	NONE <u>CHARA</u> BARS CLEAN HS PLAY	Sets the functionality to assign to the USER1 button on the LCD panel. NONE No assignment CHARA Character display, operation BARS Color bar ON/OFF CLEAN PM/NORM selection for SDI8 OUT HS PLAY Slow playback from SDI8
USER BUTTON2	NONE CHARA <u>MENU/USER1 LOCK</u> BARS CLEAN HS PLAY	Sets the functionality to assign to the USER2 button on the LCD panel. NONE No assignment CHARA Character display, operation MENU/USER1 LOCK Invalidate [MENU] button, USER1 button (Function is assigned, but nothing happens when button pressed.) BARS Color bar ON/OFF CLEAN PM/NORM selection for SDI8 OUT HS PLAY Slow playback from SDI8
TALLY	<u>MAKE</u> V	Select the input format for the TALLY signal. MAKE When the circuit between the TALLY IN H terminal and TALLY IN C terminal is OPEN, TALLY is OFF, and when it is MAKE, TALLY is ON. <ul style="list-style-type: none"> The TALLY IN H terminal is internally pulled up to +5 V with a 2.2 K resistor through a protective diode. The maximum current is 20 mA or less. V When voltage is applied to the TALLY IN H terminal, TALLY is ON, and when voltage is not applied, TALLY is OFF. Connect TALLY IN C to GND. <ul style="list-style-type: none"> A resistor of about 12.4 kΩ is inserted between TALLY IN H and TALLY IN C. The maximum voltage that can be applied is 24 V, and the maximum current is 20 mA.
PANEL LED BRIGHT	1 to <u>2</u> to 4	Sets the brightness of the front panel indicators.
LAN TRUNK	-	Sets the communication speed for when LAN TRUNK is used.

ND/CC NAME

This is the selection screen for the ND/CC NAME menu.

```

->*** ND/CC NAME ***

ND FILTER_1 NAME      1
ND FILTER_2 NAME      2
ND FILTER_3 NAME      3
ND FILTER_4 NAME      4
ND FILTER_5 NAME      5
CC FILTER_1 NAME      A
CC FILTER_2 NAME      B
CC FILTER_3 NAME      C
CC FILTER_4 NAME      D
CC FILTER_5 NAME      E
  
```

Item	Setting value	Setting details
ND FILTER_1 NAME	5 characters (Factory setting: 1)	Set the name (maximum 5 characters) of ND filter 1 (CAP). The name set here is displayed in the status display (STATUS2). Characters which can be used: Alphanumeric characters, spaces, ! " # \$ % & ' () * + , - . /
ND FILTER_2 NAME	5 characters (Factory setting: 2)	Set the name (maximum 5 characters) of ND filter 2 (CLEAR). The name set here is displayed in the status display (STATUS2). Characters which can be used: Alphanumeric characters, spaces, ! " # \$ % & ' () * + , - . /
ND FILTER_3 NAME	5 characters (Factory setting: 3)	Set the name (maximum 5 characters) of ND filter 3 (1/4). The name set here is displayed in the status display (STATUS2). Characters which can be used: Alphanumeric characters, spaces, ! " # \$ % & ' () * + , - . /
ND FILTER_4 NAME	5 characters (Factory setting: 4)	Set the name (maximum 5 characters) of ND filter 4 (1/16). The name set here is displayed in the status display (STATUS2). Characters which can be used: Alphanumeric characters, spaces, ! " # \$ % & ' () * + , - . /
ND FILTER_5 NAME	5 characters (Factory setting: 5)	Set the name (maximum 5 characters) of ND filter 5 (1/64). The name set here is displayed in the status display (STATUS2). Characters which can be used: Alphanumeric characters, spaces, ! " # \$ % & ' () * + , - . /
CC FILTER_1 NAME	5 characters (Factory setting: A)	Set the name (maximum 5 characters) of CC filter 1 (CROSS). The name set here is displayed in the status display (STATUS2). Characters which can be used: Alphanumeric characters, spaces, ! " # \$ % & ' () * + , - . /
CC FILTER_2 NAME	5 characters (Factory setting: B)	Set the name (maximum 5 characters) of CC filter 2 (3200K). The name set here is displayed in the status display (STATUS2). Characters which can be used: Alphanumeric characters, spaces, ! " # \$ % & ' () * + , - . /
CC FILTER_3 NAME	5 characters (Factory setting: C)	Set the name (maximum 5 characters) of CC filter 3 (4300K). The name set here is displayed in the status display (STATUS2). Characters which can be used: Alphanumeric characters, spaces, ! " # \$ % & ' () * + , - . /
CC FILTER_4 NAME	5 characters (Factory setting: D)	Set the name (maximum 5 characters) of CC filter 4 (6300K). The name set here is displayed in the status display (STATUS2). Characters which can be used: Alphanumeric characters, spaces, ! " # \$ % & ' () * + , - . /
CC FILTER_5 NAME	5 characters (Factory setting: E)	Set the name (maximum 5 characters) of CC filter 5 (DF0). The name set here is displayed in the status display (STATUS2). Characters which can be used: Alphanumeric characters, spaces, ! " # \$ % & ' () * + , - . /

NOTE

- When AK-UC3300 and AK-PLV100 are connected, the display for "ND/CC NAME" changes to "ND NAME" and [ND FILTER 5 NAME] is not displayed.
- When AK-UC3300 and AK-PLV100 are connected, [CC FILTER_1 NAME] to [CC FILTER_5 NAME] are not displayed.

CCU VERSION

This is the selection screen for the CCU VERSION menu.

->*** CCU VERSION(1/2) ***		->*** CCU VERSION(2/2) ***	
CCU VERSION	01.00-000-00.00	MAIN FPGA	01.00-000-00.00
CPU FPGA LOGIC	01.00-000-00.00	RET FPGA 10G	01.00-000-00.00
CPU FPGA RTOS	01.00-000-00.00	RET FPGA 25G	01.00-000-00.00
CPU FPGA LINUX	01.00-000-00.00	RET FPGA LANT MB	01.00-000-00.00
CPU FPGA NET MB	01.00-000-00.00	UHD FPGA	01.00-000-00.00
CPU FPGA CONT MB	01.00-000-00.00	INCOM FPGA	01.00-000-00.00

Item	Setting value	Setting details
CCU VERSION	Display only	Displays the version of the entire unit.
CPU FPGA LOGIC	Display only	Displays the CPU FPGA version.
CPU FPGA RTOS	Display only	Displays the software version of the CPU RTOS.
CPU FPGA LINUX	Display only	Displays the software version of the CPU LINUX.
CPU FPGA NET MB	Display only	Displays the CPU Network MicroBraze version.
CPU FPGA CONT MB	Display only	Displays the CPU Control MicroBraze version.
MAIN FPGA	Display only	Displays the MAIN FPGA version.
RET FPGA 10G	Display only	Displays the RETURN FPGA (10G) version.
RET FPGA 25G	Display only	Displays the RETURN FPGA (25G) version.
RET FPGA LANT MB	Display only	Displays the RETURN LANTRUNK MicroBraze version.
UHD FPGA	Display only	Displays the UHD FPGA version.
INCOM FPGA	Display only	Displays the INCOM FPGA version.

OPTION VERSION

This is the selection screen for the OPTION VERSION menu.

->*** OPTION VERSION(1/2) ***		->*** OPTION VERSION(2/2) ***	
MOIP VERSION	01.00-000-00.00	CODEC VERSION	01.00-000-00.00
MOIP FPGA NC 10G	01.00-000-00.00	DANTE VERSION	01.00-000-00.00
MOIP FPGA JX 10G	01.00-000-00.00		
MOIP FPGA NC 25G	01.00-000-00.00		
MOIP FPGA JX 25G	01.00-000-00.00		
MOIP FPGA MB	01.00-000-00.00		

Item	Setting value	Setting details
MOIP VERSION	Display only	Displays the MOIP version.
MOIP FPGA NC 10G	Display only	Displays the version of the MOIP FPGA (uncompressed 10G).
MOIP FPGA JX 10G	Display only	Displays the MOIP FPGA (JPEG XS 10G) version.
MOIP FPGA NC 25G	Display only	Displays the version of the MOIP FPGA (uncompressed 25G).
MOIP FPGA JX 25G	Display only	Displays the MOIP FPGA (JPEG XS 25G) version.
MOIP FPGA MB	Display only	Displays the MOIP MicroBraze version.
CODEC VERSION	Display only	Displays the CODEC version.
DANTE VERSION	Display only	Displays the DANTE version.

PM VIEW SETTING

This is the selection screen for the PM VIEW SETTING menu.

->*** PM VIEW SETTING(1/2) ***		->*** PM VIEW SETTING(2/2) ***	
CAMERA No.	ON	TALLY INFO	ON
SYSTEM FORMAT	ON	F.DROP	OFF
FORMAT MODE	ON	ZOOM POSITION	ON
SCENE FILE No.	ON	FOCUS POSITION	ON
SHUTTER	ON	OPT_CAM	ON
ND/CC FILTER	ON	OPT_CCU	ON
EXTENDER INFO	ON	COLORIMETRY	ON
IRIS	ON		
IRIS LEVEL	ON		
IRIS SCALE	FULL		
COLOR TEMP VALUE	ON		

___ indicates factory default settings.

Item	Setting value	Setting details
CAMERA No.	<u>ON</u> OFF	Set display of the camera number on the picture monitor to ON or OFF.
SYSTEM FORMAT	<u>ON</u> OFF	Set display of the system format on the picture monitor to ON or OFF.
FORMAT MODE	<u>ON</u> OFF	Set display of the format mode on the picture monitor to ON or OFF.
SCENE FILE No.	<u>ON</u> OFF	Set display of the scene file number on the picture monitor to ON or OFF.
SHUTTER	<u>ON</u> OFF	Set display of the shutter value on the picture monitor to ON or OFF.
ND/CC FILTER	<u>ON</u> OFF	Set display of the ND/CC filter name to the picture monitor to ON or OFF.
EXTENDER INFO	<u>ON</u> OFF	Set display of extender information (extender and digital extender) on the picture monitor to ON or OFF.
IRIS	<u>ON</u> OFF	Set display of the IRIS F value on the picture monitor to ON or OFF.
IRIS LEVEL	<u>ON</u> OFF	Set display of the IRIS level bar on the picture monitor to ON or OFF. • When [OFF] is set, the IRIS menu is not displayed on the picture monitor.
IRIS SCALE	FULL <u>2STOP</u>	Set the IRIS display range of the status display screen.
COLOR TEMP VALUE	<u>ON</u> OFF	Set display of the color temperature on the picture monitor to ON or OFF.
TALLY INFO	<u>ON</u> OFF	Set display of the tally information on the picture monitor to ON or OFF.
F.DROP	ON <u>OFF</u>	Shows/hides the F.DROP that is notified by the camera, on the picture monitor.
ZOOM POSITION	<u>ON</u> OFF	Set display of the zoom position information, which is notified by the camera, on the picture monitor to ON or OFF.
FOCUS POSITION	<u>ON</u> OFF	Set display of the focus position information, which is notified by the camera, on the picture monitor to ON or OFF.
OPT_CAM	<u>ON</u> OFF	Set display of the optical signal level (camera side) on the picture monitor to ON or OFF.
OPT_CCU	<u>ON</u> OFF	Set display of the optical signal level (CCU side) on the picture monitor to ON or OFF.
COLORIMETRY	<u>ON</u> OFF	Set display of COLORIMETRY (Y/C conversion coefficient), which is notified by the camera, on the picture monitor to ON or OFF.

PM OPERATION STATUS

This is the selection screen for the PM OPERATION STATUS menu.

->*** PM OPERATION STATUS ***	
STATUS DISPLAY TIME	4
MANUAL OPERATION STATUS	
MASTER GAIN	ON
SHUTTER	ON
LENS EXTENDER	ON
FILTER	ON
SCENE FILE	ON
REF LOAD	ON
AUTO OPERATION STATUS	ON

___ indicates factory default settings.

Item	Setting value	Setting details
STATUS DISPLAY TIME	0 2 4	Set display of the status display time on the picture monitor to ON or OFF.
MANUAL OPERATION STATUS		
▶ MASTER GAIN	ON OFF	Set display of picture monitor operation display item (MASTER GAIN) ON/OFF.
▶ SHUTTER	ON OFF	Set display of the picture monitor operation display item (SHUTTER) to ON or OFF.
▶ LENS EXTENDER	ON OFF	Set display of the picture monitor operation display item (LENS EXT) to ON or OFF.
▶ FILTER	ON OFF	Set display of picture monitor operation display item (FILTER) to ON or OFF.
▶ SCENE FILE	ON OFF	Set display of picture monitor operation display item (SCENE FILE) to ON or OFF.
▶ REF LOAD	ON OFF	Set display of picture monitor operation display item (REF LOAD) ON/OFF.
AUTO OPERATION STATUS	ON OFF	Set display of picture monitor operation display item (AUTO) to ON or OFF.

SYSTEM

This is the selection screen for the SYSTEM menu.

```

->*** SYSTEM ***

INITIALIZE                NO?
FACTORY INITIALIZE        NO?
CCU CUSTOM DATA LOAD    NO?
CCU CUSTOM DATA SAVE    CURRENT
ROP CONNECT SERIAL        -----
ROP CONNECT NETWORK      -----
  
```

___ indicates factory default settings.

Item	Setting value	Setting details
INITIALIZE	NO? YES?	Return the menu items to the factory default values. ➔ "Initialize the Unit Settings (INITIALIZE)" (see page 89)
FACTORY INITIALIZE	NO? YES?	Return the unit's settings to the factory default values. Select [YES?] and press the [SELECT] dial to start initialization. <ul style="list-style-type: none"> Controls from the camera, ROP, or MSU cannot be performed during initialization.
CCU CUSTOM DATA LOAD	NO? YES?	Call the CCU management data stored in the CCU.
CCU CUSTOM DATA SAVE	CURRENT FACTORY CANCEL	Store the setting data managed by the CCU inside the CCU. The items that are stored are the same as the items set with [FACTORY INITIALIZE]. CURRENT Saves the values currently set for the CCU. FACTORY Saves the values set with [FACTORY INITIALIZE].
ROP CONNECT SERIAL	CONNECT -----	Displays the status of ROP connection (serial connection) to the unit. CONNECT Connection is to the [ROP] connector. ----- No serial connection.
ROP CONNECT NETWORK	CONNECT -----	Displays the status of ROP connection (IP connection) to the unit. CONNECT Connection is by IP connection. ----- No IP connection.

Initialize the Unit Settings (INITIALIZE)

Initialization Procedure

1. Turn the [SELECT] dial to move the cursor to [INITIALIZE], and then press the [SELECT] dial.
2. Turn the [SELECT] dial to select [YES?], and then press the [SELECT] dial.

Initialization begins.

Data Initialized

✓: Initialized ×: Not initialized

CCU menu	INITIALIZE	FACTORY INITIALIZE
OPERATION	✓	✓
AUDIO	✓	✓
NETWORK	×	✓
MAINTENANCE		
▶ START UP	✓ (excluding [CONNECT MODE])	✓
▶ SETUP	✓	✓
▶ ND/CC NAME	✓	✓
▶ CCU VERSION	×	×
▶ OPTION VERSION	×	×
▶ PM VIEW SETTING	✓	✓
▶ PM OPERATION STATUS	✓	✓
▶ SYSTEM	×	×
▶ SD CARD	×	×

SD CARD

This is the selection screen for the SD CARD menu.

The function is executed when you select [YES?] at each of the items.

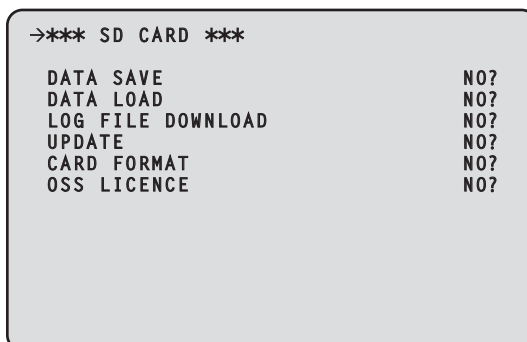

___ indicates factory default settings.

Item	Setting value	Setting details
DATA SAVE	NO? YES?	Save the unit's setting information to memory card.
DATA LOAD	NO? YES?	Load the unit's setting information saved in memory card to this unit.
LOG FILE DOWNLOAD	NO? YES?	Save CCU (this unit) log information to memory card.
UPDATE	NO? YES?	Upgrade the unit's software or programs (FPGA) with files saved to the memory card.
CARD FORMAT	NO? YES?	Initialize the memory card. <ul style="list-style-type: none"> Initialization may take about 5 minutes. Be sure to execute initialization after confirming the data because any data that is deleted by the initialization cannot be recovered.
OSS LICENCE	NO? YES?	Record OSS license terms to an SD card. The file generated will be named "LICENSE1.TXT", "LICENSE2.TXT", "LICENSE3.TXT".

Data Stored/Loaded

The following data is stored/loaded.

- Items in the [OPERATION] menu
- Items in the [MAINTENANCE] menu
(The [CCU VERSION] menu, [OPTION VERSION] menu, [SYSTEM] menu, and [SD CARD] menu are excluded.)
- Items in the [SYSTEM] menu

SD Card Error Messages

When an error occurs during processing of SD card menu items, the following messages are displayed.

Messages	Content and remedy
LOAD ERROR	Unable to read from the memory card. <ul style="list-style-type: none"> • Data written with other than this unit cannot be read.
WRITE ERROR	Unable to write to the memory card. <ul style="list-style-type: none"> • The memory card is likely to be defective. Replace the memory card.

Saving and loading reference files and scene files

When reference files and scene files are saved or loaded from the ROP, the following data applies.

Menu	Saved / loaded data	
	Reference file	Scene file
AUDIO	MIC OUT CCU INTERCOM TALK CCU INTERCOM RECEIVE STANDBY INTERCOM COMMUNICATION INTERCOM1 INTERCOM2 PGM	-
MAINTENANCE	ND/CC NAME	-

Web Screen

Network settings

Software

Download EasyIP Setup Tool Plus from the following website and then install them. [Windows]

- **Download URL**
<https://pro-av.panasonic.net/en/>

EasyIP Setup Tool Plus

This software sets the unit's network settings.

➔ "Using EasyIP Setup Tool Plus to set the unit's settings" (see page 92)

Using EasyIP Setup Tool Plus to set the unit's settings

The settings related to the unit's network can be set using the supplied EasyIP Setup Tool Plus.

When multiple of this unit are to be set, they each need to be set individually.

If setting cannot be done using the EasyIP Setup Tool Plus, make the individual settings for this unit and the personal computer in [NETWORK] > [NDI/SRT SETTING] in the CCU menu.

➔ "NDI/SRT SETTING" (see page 79)

NOTE

- If, after the network settings have been set, another device on the same network has the same IP address, the network operations will not be performed properly. Set the IP address in such a way that it does not duplicate an existing IP address.
- Do not set network settings from a multiple number of EasyIP Setup Tool Plus programs at the same time for a single camera. When connected from more than one PC, the settings of this unit can only be changed from the PC that was connected first.
- EasyIP Setup Tool Plus cannot be used from a different subnet via a router.
- Changes to the settings of this unit using the EasyIP Setup Tool Plus are performed with authentication from an account in the web screen, therefore changes are not possible if the initial account for the web screen is not yet set.
 - ➔ "Displaying the web screen using a personal computer" (see page 94)

Setting Procedure

1. Start the EasyIP Setup Tool Plus.
2. Click the [Search] button.

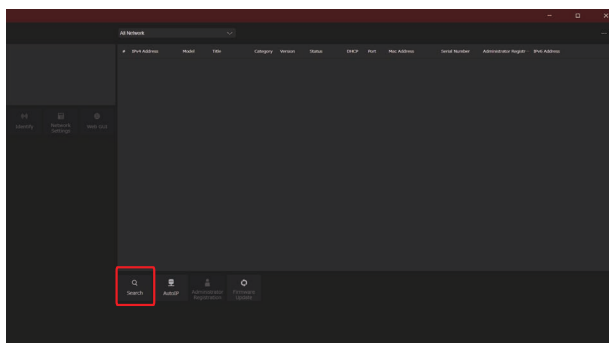

- You can set the Network to be used for the search in the selection menu at the top of the screen.

3. Select the camera to configure and click the [Network Settings] button.

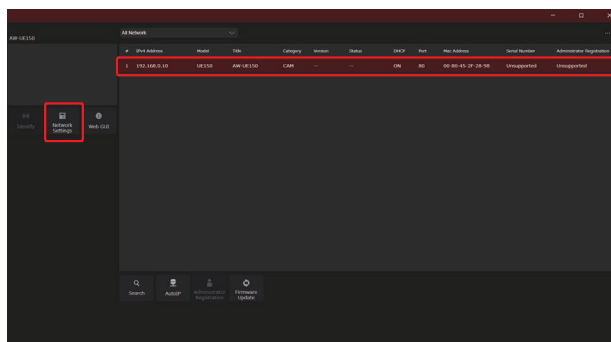

- The web screen for the selected camera is displayed when you click the [Web GUI] button.

4. Input the network items, and click the [Setup] button.

- Port No. settings are not supported, so do not set.

5. Enter the user name and password registered in the web screen, then click the [OK] button.

- Enter the user name and password that was set for the initial account or was set in the User management screen [USER MNG.] in the web screen.
 - ➔ “Displaying the web screen using a personal computer” (see page 94)
 - ➔ “User management screen [USER MNG.]” (see page 127)
- After the [OK] button is clicked, it takes about 2 minutes for the settings in the unit to be completed. If this unit is turned off or the LAN cable is disconnected before the settings are completed, the settings will be invalidated. In this case, repeat the steps to set the settings.

NOTE

- The unit does not support IPv6.
- This unit does not support “Administrator Registration”, and “Firmware Update” from EasyIP Setup Tool Plus.
- When a firewall (including software) has been introduced, enable access to all the UDP ports.
- For details about EasyIP Setup Tool Plus, refer to the Help page.

Displaying the web screen

Connect the LAN connector on this unit and a personal computer and make a variety of settings in a web browser.

Use a LAN crossover cable to directly connect the LAN connector on this unit and a personal computer. When connecting via a switching hub, etc., use a LAN straight cable.

Notice regarding the Web screen

IP address and subnet mask

Select an IP address for the personal computer within the private address range while ensuring that it is different from the address of the unit. Set the subnet mask to the same address as the unit.

- **Unit's IP address and subnet mask (factory settings)**

IP address	192.168.0.20
Subnet mask	255.255.255.0

Personal computer environment required to display the Web screen

For details on the personal computer environment required to display the Web screen, refer to following page.

➡ "Personal computer requirements" (see page 10)

Displaying the web screen using a personal computer

Screens from Windows (Microsoft Edge) are used as examples in this manual. There will be some differences in how the screen appears in other browsers, but the procedures will be the same.

1. Start the web browser of the personal computer.

Use one of the web browsers below depending on the operating system installed in the personal computer.

Installed OS	Web browser
Windows	Microsoft Edge
	Google Chrome
macOS	Safari

2. Enter the IP address you configured on the EasyIP Setup Tool Plus in the address bar of the web browser.

- Example of input
http://registered URL
http://192.168.0.20

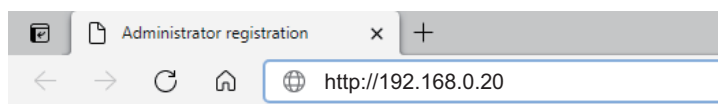

- If this unit is within a local network, make the settings for the proxy server from the web browser so that the proxy server is not used for the local address.

3. Sets the initial account.

If the web screen is set to be shown in the initial state, the initial account setting screen is displayed.

Set the user name and password.

NOTE

- Do not use a string of characters that can be easily guessed by a third party.
- Change your password regularly.
- Use at least 3 of the following 4 character types in a password of at least 8-characters in length.
 - Upper case alphabet
 - Lower case alphabet
 - Numbers
 - Symbols (! # \$ % ' () * + , - . / ? @ [] ^ _ ` ~)
- If a password is set that does not follow the above policy, the user assumes responsibility for operation, with an adequate understanding of the security risks to the installation environment, etc.
- A warning message is displayed if you set a password that does not meet the recommended setting policy. To change the password, click the [Back] button and enter another password. To continue the settings after understanding the risk to security, click [Continue] and then complete the settings.
- If you have forgotten the account information you set, execute [SYSTEM] > [FACTORY INITIALIZE] in the CCU menu, and reset the user information used for network connections. The settings for this unit return to the factory settings when you execute [FACTORY INITIALIZE].
 - ➡ “Initialize the Unit Settings (INITIALIZE)” (see page 89)

4. Complete registration of the initial account.

The following screen indicating registration completion is displayed after registration of the initial account is complete.

After about 10 seconds of showing this completion screen, the settings screen is automatically shown. If the screen does not transition to the settings screen even after 10 seconds have elapsed, click on the link in "please click here" to move to the settings screen manually.

This completes the procedures for registering the initial account.

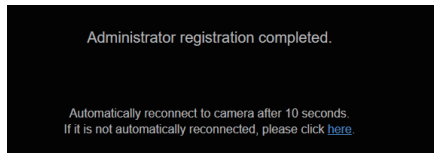

5. Display the settings screen.

The web screen is displayed.

In the initial screen, the Product information screen [PRODUCT INFO.] is displayed, so switch if necessary.

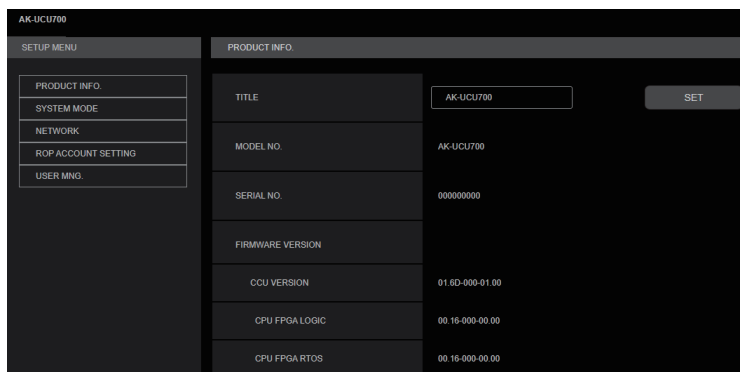

Logging into the web screen

When the web screen is displayed, you need to enter the account information.

NOTE

- The account input screen appears as a pop-up window in the web browser.
- Correctly enter the user name and password that were previously registered.
- It is recommended to regularly change the password.

Web setting screen

This screen enables you to make a variety of settings for this unit.

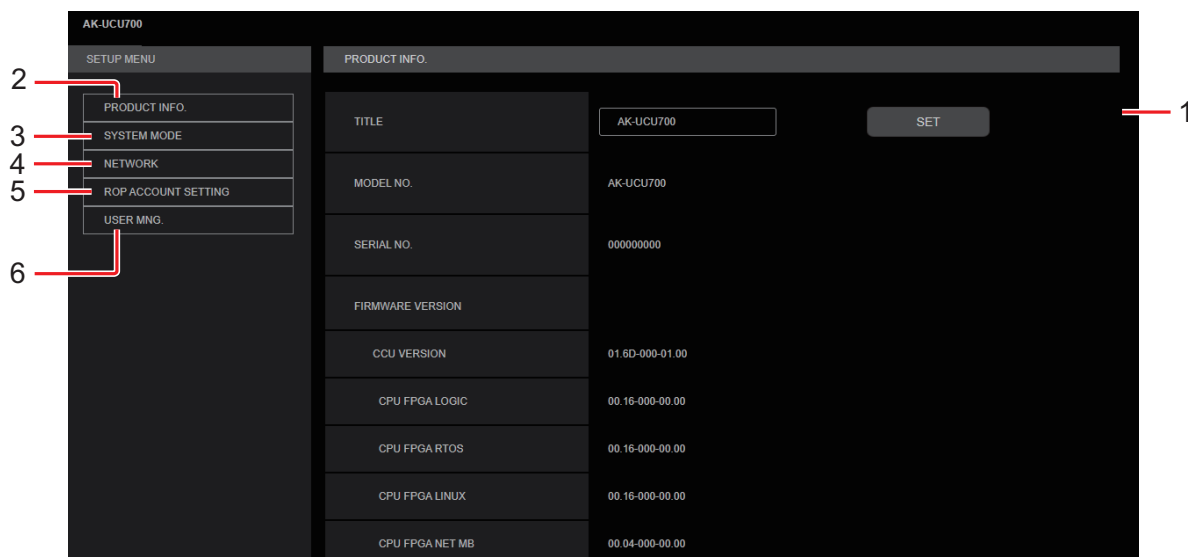

1	Main area	The menu screen appears.
2	Product information button [PRODUCT INFO.]	Click the button to display the Product information screen [PRODUCT INFO.]. ➡ "Product information screen [PRODUCT INFO.]" (see page 98)
3	View system settings button [SYSTEM MODE]	Click the button to display the View system settings screen [SYSTEM MODE]. ➡ "View system settings screen [SYSTEM MODE]" (see page 100)
4	Network settings button [NETWORK]	Click the button to display the Network settings screen [NETWORK]. ➡ "Network settings screen [NETWORK]" (see page 104)
5	ROP account settings button [ROP ACCOUNT SETTING]	Click the button to display the ROP account settings screen [ROP ACCOUNT SETTING]. ➡ "ROP account settings screen [ROP ACCOUNT SETTING]" (see page 126)
6	User management settings button [USER MNG.]	Click the button to display the User management screen [USER MNG.]. ➡ "User management screen [USER MNG.]" (see page 127)

NOTE

- If setting values are changed from a menu or another web browser while the settings menu is being displayed, there may be a mismatch between the setting values and the displayed values. If this occurs, refresh the screen displaying the settings menu in the web browser.

Product information screen [PRODUCT INFO.]

The versions of the unit's software can be checked on this screen.

The [MODEL NO.], [SERIAL NO.], [FIRMWARE VERSION] and other information about the unit is displayed.

PRODUCT INFO.	
TITLE	AK-UCU700 SET
MODEL NO.	AK-UCU700
SERIAL NO.	00000000
FIRMWARE VERSION	
CCU VERSION	01.6D-000-01.00
CPU FPGA LOGIC	00.16-000-00.00
CPU FPGA RTOS	00.16-000-00.00
CPU FPGA LINUX	00.16-000-00.00
CPU FPGA NET MB	00.04-000-00.00
CPU FPGA CONT MB	00.01-000-00.00
MAIN FPGA	00.09-000-00.00
RET FPGA 10G	00.16-000-00.00
RET FPGA 25G	00.01-000-00.00
RET FPGA LANT MB	00.02-000-00.00
UHD FPGA	00.04-000-00.00
INCOM FPGA	01.00-000-01.00
MOIP VERSION	00.58-000-00.00
MOIP FPGA NC 10G	00.15-000-00.00
MOIP FPGA JX 10G	00.15-000-00.00
MOIP FPGA NC 25G	00.15-000-00.00
MOIP FPGA JX 25G	00.15-000-00.00
MOIP FPGA MB	00.04-000-00.00
CODEC VERSION	00.06-000-00.00
DANTE VERSION	00.06-000-00.00

___ indicates factory default settings.

Item	Display description
TITLE	AK-UCU700 Set the camera name displayed in the header of the web screen and in EasyIP Setup Tool Plus.
MODEL NO.	Display the unit's model number.
SERIAL NO.	Displays the unit's serial number.
FIRMWARE VERSION	CCU VERSION Displays the overall version of the unit. CPU FPGA LOGIC Displays the CPU FPGA version. CPU FPGA RTOS Displays the software version of the CPU RTOS. CPU FPGA LINUX Displays the software version of the CPU LINUX. CPU FPGA NET MB Displays the CPU Network MicroBraze version. CPU FPGA CONT MB Displays the CPU Control MicroBraze version.

Item	Display description
FIRMWARE VERSION	<p>MAIN FPGA Displays the MAIN FPGA version.</p> <p>RET FPGA 10G Displays the RETURN FPGA (10G) version.</p> <p>RET FPGA 25G Displays the RETURN FPGA (25G) version.</p> <p>RET FPGA LANT MB Displays the RETURN LANTRUNK MicroBraze version.</p> <p>UHD FPGA Displays the UHD FPGA version.</p> <p>INCOM FPGA Displays the INCOM FPGA version.</p> <p>MOIP VERSION Displays the MOIP version.</p> <p>MOIP FPGA NC 10G Displays the version of the MOIP FPGA (uncompressed 10G).</p> <p>MOIP FPGA JX 10G Displays the MOIP FPGA (JPEG XS 10G) version.</p> <p>MOIP FPGA NC 25G Displays the version of the MOIP FPGA (uncompressed 25G).</p> <p>MOIP FPGA JX 25G Displays the MOIP FPGA (JPEG XS 25G) version.</p> <p>MOIP FPGA MB Displays the MOIP MicroBraze version.</p> <p>CODEC VERSION Displays the CODEC version.</p> <p>DANTE VERSION Displays the DANTE version.</p>

View system settings screen [SYSTEM MODE]

The View system settings screen [SYSTEM MODE] enables you to view the related image format, received image information, etc., when this unit is to use MoIP.

The View system settings screen [SYSTEM MODE] consists of [MAIN], [ST2110 TX SW], [SFP TX STATUS], [SFP1(PRIMARY) RX STATUS], and [SFP2(SECONDARY)RX STATUS].

When the AK-NP701 option board is not attached, the information set in this screen for [ST2110 TX SW], [SFP TX STATUS], [SFP1(PRIMARY) RX STATUS], and [SFP2(SECONDARY)RX STATUS] is not enabled.

MAIN

Click [MAIN] in the View system settings screen [SYSTEM MODE].

You can view the basic settings for the unit.

Item	Display description
FORMAT	Displays the CCU format settings.

ST2110 TX SW

Click [ST2110 TX SW] in the View system settings screen [SYSTEM MODE].

Displays the [ST2110 TX SW] settings screen.

Confirm the settings with the [SET] button.

___ indicates factory default settings.

Item	Setting value	Setting details
MAIN VIDEO	ENABLE <u>DISABLE</u>	Transmission can be enabled/disabled.
MONITOR VIDEO	ENABLE <u>DISABLE</u>	Transmission can be enabled/disabled.
HD TRUNK VIDEO	ENABLE <u>DISABLE</u>	Transmission can be enabled/disabled.
HD TRUNK AUDIO	ENABLE <u>DISABLE</u>	Transmission can be enabled/disabled.
MIC1	ENABLE <u>DISABLE</u>	Transmission can be enabled/disabled.
MIC2	ENABLE <u>DISABLE</u>	Transmission can be enabled/disabled.
INCOM1	ENABLE <u>DISABLE</u>	Transmission can be enabled/disabled.
INCOM2	ENABLE <u>DISABLE</u>	Transmission can be enabled/disabled.

Note that when [NMOS SETTING] > [NMOS CONTROL] is [ON], the instructions from the external NMOS CONTROL are prioritized.

SFP TX STATUS

Click [SFP TX STATUS] in the View system settings screen [SYSTEM MODE].

You can view the format of the TX signal source.

Item	Display description
MAIN VIDEO FORMAT	Displays the settings for the format of images output from the main output line.
MONITOR VIDEO FORMAT	Displays the settings for the format of images output from the monitor.
HD TRUNK VIDEO FORMAT	Displays the settings for the format of the HD trunk.
HD TRUNK AUDIO	Displays the enable/disable settings for audio output.
HD TRUNK AUDIO FORMAT	Displays the settings for audio output format.

SFP1(PRIMARY)RX STATUS

Click [SFP1(PRIMARY)RX STATUS] in the View system settings screen [SYSTEM MODE].

This will display the received data information for the SFP1(PRIMARY) RX signals.

Item	Display description
RETURN1 VIDEO	<p>The reception status is displayed as Detect (receiving)/Undetected (not receiving). The following information is also displayed:</p> <p>SAMPLING RATE Displays the sampling rate of the received return images 1.</p> <p>WIDTH Displays the horizontal resolution of the received return images 1.</p> <p>HEIGHT Displays the vertical resolution of the received return images 1.</p>
RETURN2 VIDEO	<p>The reception status is displayed as Detect (receiving)/Undetected (not receiving). The following information is also displayed:</p> <p>SAMPLING RATE Displays the sampling rate of the received return images 2.</p> <p>WIDTH Displays the horizontal resolution of the received return images 2.</p> <p>HEIGHT Displays the vertical resolution of the received return images 2.</p>
RETURN3 VIDEO	<p>The reception status is displayed as Detect (receiving)/Undetected (not receiving). The following information is also displayed:</p> <p>SAMPLING RATE Displays the sampling rate of the received return images 3.</p> <p>WIDTH Displays the horizontal resolution of the received return images 3.</p> <p>HEIGHT Displays the vertical resolution of the received return images 3.</p>
RETURN4 VIDEO	<p>The reception status is displayed as Detect (receiving)/Undetected (not receiving). The following information is also displayed:</p> <p>SAMPLING RATE Displays the sampling rate of the received return images 4.</p> <p>WIDTH Displays the horizontal resolution of the received return images 4.</p> <p>HEIGHT Displays the vertical resolution of the received return images 4.</p>
HD PROMPTER	<p>The reception status is displayed as Detect (receiving)/Undetected (not receiving). The following information is also displayed:</p> <p>SAMPLING RATE Displays the sampling rate of the received HD PROMPTER RX.</p> <p>WIDTH Displays the horizontal resolution of the received HD PROMPTER RX.</p> <p>HEIGHT Displays the vertical resolution of the received HD PROMPTER RX.</p>
HD PROMPTER AUDIO	<p>The reception status is displayed as Detect (receiving)/Undetected (not receiving). The following information is also displayed:</p> <p>SAMPLING RATE Displays the sampling rate of the received HD PROMPTER AUDIO RX.</p> <p>PAYLOAD TYPE Displays the payload type of the received HD PROMPTER AUDIO RX.</p>
PGM1	<p>The reception status is displayed as Detect (receiving)/Undetected (not receiving). The following information is also displayed:</p> <p>SAMPLING RATE Displays the sampling rate of the received PGM1 AUDIO RX.</p> <p>PAYLOAD TYPE Displays the payload type of the received PGM1 AUDIO RX.</p>

Item	Display description
PGM2	The reception status is displayed as Detect (receiving)/Undetected (not receiving). The following information is also displayed: SAMPLING RATE Displays the sampling rate of the received PGM2 AUDIO RX. PAYLOAD TYPE Displays the payload type of the received PGM2 AUDIO RX.
INCOM1	The reception status is displayed as Detect (receiving)/Undetected (not receiving). The following information is also displayed: SAMPLING RATE Displays the sampling rate of the received INCOM1 AUDIO RX. PAYLOAD TYPE Displays the payload type of the received INCOM1 AUDIO RX.
INCOM2	The reception status is displayed as Detect (receiving)/Undetected (not receiving). The following information is also displayed: SAMPLING RATE Displays the sampling rate of the received INCOM2 AUDIO RX. PAYLOAD TYPE Displays the payload type of the received INCOM2 AUDIO RX.
RETURN1 JPEG XS FORMAT	The reception status is displayed as Detect (receiving)/Undetected (not receiving).
RETURN2 JPEG XS FORMAT	The reception status is displayed as Detect (receiving)/Undetected (not receiving).
RETURN3 JPEG XS FORMAT	The reception status is displayed as Detect (receiving)/Undetected (not receiving).
RETURN4 JPEG XS FORMAT	The reception status is displayed as Detect (receiving)/Undetected (not receiving).

SFP2(SECONDARY)RX STATUS

Click [SFP2(SECONDARY)RX STATUS] in the View system settings screen [SYSTEM MODE].

This will display the received data information for the SFP2(SECONDARY) RX signals.

Item	Display description
RETURN1 VIDEO	The reception status is displayed as Detect (receiving)/Undetected (not receiving). The following information is also displayed: SAMPLING RATE Displays the sampling rate of the received return images 1. WIDTH Displays the horizontal resolution of the received return images 1. HEIGHT Displays the vertical resolution of the received return images 1.
RETURN2 VIDEO	The reception status is displayed as Detect (receiving)/Undetected (not receiving). The following information is also displayed: SAMPLING RATE Displays the sampling rate of the received return images 2. WIDTH Displays the horizontal resolution of the received return images 2. HEIGHT Displays the vertical resolution of the received return images 2.
RETURN3 VIDEO	The reception status is displayed as Detect (receiving)/Undetected (not receiving). The following information is also displayed: SAMPLING RATE Displays the sampling rate of the received return images 3. WIDTH Displays the horizontal resolution of the received return images 3. HEIGHT Displays the vertical resolution of the received return images 3.
RETURN4 VIDEO	The reception status is displayed as Detect (receiving)/Undetected (not receiving). The following information is also displayed: SAMPLING RATE Displays the sampling rate of the received return images 4. WIDTH Displays the horizontal resolution of the received return images 4. HEIGHT Displays the vertical resolution of the received return images 4.

Item	Display description
HD PROMPTER	<p>The reception status is displayed as Detect (receiving)/Undetected (not receiving). The following information is also displayed:</p> <p>SAMPLING RATE Displays the sampling rate of the received HD PROMPTER RX.</p> <p>WIDTH Displays the horizontal resolution of the received HD PROMPTER RX.</p> <p>HEIGHT Displays the vertical resolution of the received HD PROMPTER RX.</p>
HD PROMPTER AUDIO	<p>The reception status is displayed as Detect (receiving)/Undetected (not receiving). The following information is also displayed:</p> <p>SAMPLING RATE Displays the sampling rate of the received HD PROMPTER AUDIO RX.</p> <p>PAYLOAD TYPE Displays the payload type of the received HD PROMPTER AUDIO RX.</p>
PGM1	<p>The reception status is displayed as Detect (receiving)/Undetected (not receiving). The following information is also displayed:</p> <p>SAMPLING RATE Displays the sampling rate of the received PGM1 AUDIO RX.</p> <p>PAYLOAD TYPE Displays the payload type of the received PGM1 AUDIO RX.</p>
PGM2	<p>The reception status is displayed as Detect (receiving)/Undetected (not receiving). The following information is also displayed:</p> <p>SAMPLING RATE Displays the sampling rate of the received PGM2 AUDIO RX.</p> <p>PAYLOAD TYPE Displays the payload type of the received PGM2 AUDIO RX.</p>
INCOM1	<p>The reception status is displayed as Detect (receiving)/Undetected (not receiving). The following information is also displayed:</p> <p>SAMPLING RATE Displays the sampling rate of the received INCOM1 AUDIO RX.</p> <p>PAYLOAD TYPE Displays the payload type of the received INCOM1 AUDIO RX.</p>
INCOM2	<p>The reception status is displayed as Detect (receiving)/Undetected (not receiving). The following information is also displayed:</p> <p>SAMPLING RATE Displays the sampling rate of the received INCOM2 AUDIO RX.</p> <p>PAYLOAD TYPE Displays the payload type of the received INCOM2 AUDIO RX.</p>
RETURN1 JPEG XS FORMAT	The reception status is displayed as Detect (receiving)/Undetected (not receiving).
RETURN2 JPEG XS FORMAT	The reception status is displayed as Detect (receiving)/Undetected (not receiving).
RETURN3 JPEG XS FORMAT	The reception status is displayed as Detect (receiving)/Undetected (not receiving).
RETURN4 JPEG XS FORMAT	The reception status is displayed as Detect (receiving)/Undetected (not receiving).

Network settings screen [NETWORK]

Make settings related to the network in the Network settings screen [NETWORK].

The Network settings screen [NETWORK] consists of [LAN], [TALLY IN SETTING], [PTP SETTING]*1, [ST2110 SETTING]*1, [SFP1(PRIMARY)]*1, [SFP1(PRIMARY)TX]*1, [SFP1(PRIMARY)RX]*1, [SFP2(SECONDARY)]*1, [SFP2(SECONDARY)TX]*1, [SFP2(SECONDARY)RX]*1, [NMOS SETTING]*1, [NDI/SRT SETTING]*2, [DNS SETTING]*2, [HTTPS], and [COMMON].

*1: Can be set when the AK-NP701 option board is attached.

*2: Can be set when the AK-NP703 option board is attached.

LAN

Click [LAN] in the Network settings screen [NETWORK].

Make network settings for the [LAN] connector.

Confirm the settings with the [SET] button.

The following information is required to configure network settings. Consult your network administrator or Internet service provider.

- IP address
- Port
- Subnet mask
- Default gateway (when using a gateway server or router)
- Primary server address, secondary server address, and domain for DNS (when using DNS)

___ indicates factory default settings.

Item	Setting value	Setting details
DHCP	ON <u>OFF</u>	Select the method for setting IP addresses.
IP ADDRESS	<u>192.168.0.20</u>	When not using the DHCP function, enter IP addresses. Enter so that the address does not duplicate the IP addresses of the personal computer or other network cameras.
SUBNET MASK	<u>255.255.255.0</u>	When not using the DHCP function, enter subnet masks.
DEFAULT GATEWAY	<u>192.168.0.1</u>	When not using the DHCP function, set default gateways.
MAC ADDRESS	Display only	Displays the MAC address.

Item	Setting value	Setting details
DNS	<ul style="list-style-type: none"> DNS MANUAL AUTO PRIMARY SERVER ADDRESS 0.0.0.0 SECONDARY SERVER ADDRESS 0.0.0.0 DOMAIN The default value is blank 	<p>DNS Sets whether the DNS server address is to be acquired automatically (AUTO), or to be input manually (MANUAL).</p> <p>PRIMARY SERVER ADDRESS SECONDARY SERVER ADDRESS DOMAIN When using [MANUAL] for [DNS], enter the IP address for the DNS server.</p> <ul style="list-style-type: none"> Consult the system administrator regarding the DNS server information.

TALLY IN SETTING

Click [TALLY IN SETTING] in the Network settings screen [NETWORK].

Make settings related to Tally control via TSL Protocol 5.0.

Confirm the settings with the [SET] button.

___ indicates factory default settings.

Item	Setting value	Setting details
INDEX NO.	1 to 255	Enter the INDEX NO. set by devices that output TALLY.
PORT	60000 to <u>62000</u> to 65535	Enter the TALLY IN port number.

NOTE

- The IP address for TALLY IN will be that of the settings for the [LAN] connector.

PTP SETTING

- Can be set when the AK-NP701 option board is attached.

Click [PTP SETTING] in the Network settings screen [NETWORK].

Make PTP related network settings.

Confirm the settings with the [SET] button.

___ indicates factory default settings.

Item	Setting value	Setting details
CLOCK TYPE	BC E2E TC P2P TC	Sets the CLOCK TYPE for PTP.
DOMAIN	1 to <u>127</u>	Sets the DOMAIN number.
IP ADDRESS(PRIMARY)	Display only	Displays the IP address for PTP(PRIMARY).
IP ADDRESS(SECONDARY)	Display only	Displays the IP address for PTP(SECONDARY).
GRANDMASTER ID	Display only	Displays GRANDMASTER ID notified from the PTP server.

ST2110 SETTING

- Can be set when the AK-NP701 option board is attached.

Click [ST2110 SETTING] in the Network settings screen [NETWORK].

Item	Setting value	Setting details
SFP SPEED	Display only	Displays the SFP module SPEED setting information.
VIDEO COMP	Display only	Displays the settings for images transmitted via ST2110.

SFP1(PRIMARY)

- Can be set when the AK-NP701 option board is attached.

Click [SFP1(PRIMARY)] in the Network settings screen [NETWORK].

Make network settings for the [SFP+/SFP28] slot 1 (SFP1(PRIMARY)) for MoIP input/output.

Confirm the settings with the [SET] button.

The following information is required to configure network settings. Consult your network administrator or Internet service provider.

- IP address
- Port
- Subnet mask
- Default gateway (when using a gateway server or router)

___ indicates factory default settings.

Item	Setting value	Setting details
DHCP	ON OFF	Select the method for setting the SFP1(PRIMARY) IP addresses.
IP ADDRESS	<u>192.168.1.50</u>	When not using the DHCP function, enter the SFP1(PRIMARY) IP addresses. Enter so that the address does not duplicate the IP addresses of the personal computer or other network cameras.
PORT	1024 to <u>49300</u> to 65535 (10670 is prohibited)	Enter the SFP1(PRIMARY) port numbers.
SUBNET MASK	<u>255.255.255.0</u>	When not using the DHCP function, enter the SFP1(PRIMARY) subnet masks.
DEFAULT GATEWAY	<u>192.168.1.1</u>	When not using the DHCP function, set the SFP1(PRIMARY) default gateways.
MAC ADDRESS	Display only	Display the SFP1(PRIMARY) MAC addresses.

SFP1(PRIMARY)TX

- Can be set when the AK-NP701 option board is attached.

Click [SFP1(PRIMARY)TX] in the Network settings screen [NETWORK].

Make network settings for the SFP1(PRIMARY) TX signal.

Confirm the settings with the [SET] button.

___ indicates factory default settings.

Item	Setting value	Setting details
MAIN VIDEO TX	<ul style="list-style-type: none"> • IP ADDRESS <u>239.1.0.1</u> • PORT 1024 to <u>49311</u> to 65535 (10670 is prohibited) 	<p>IP ADDRESS Enter the IP address for MAIN VIDEO TX.</p> <p>PORT Enter the port number for MAIN VIDEO TX.</p>
JPEG XS TX	<ul style="list-style-type: none"> • IP ADDRESS <u>239.1.0.10</u> • PORT 1024 to <u>49361</u> to 65535 (10670 is prohibited) 	<p>IP ADDRESS Enter the IP address for JPEG XS TX.</p> <p>PORT Enter the port number for JPEG XS TX.</p>
MONITOR VIDEO TX	<ul style="list-style-type: none"> • IP ADDRESS <u>239.1.0.11</u> • PORT 1024 to <u>49312</u> to 65535 (10670 is prohibited) 	<p>IP ADDRESS Enter the IP address for MONITOR VIDEO TX.</p> <p>PORT Enter the port number for MONITOR VIDEO TX.</p>
HD TRUNK TX	<ul style="list-style-type: none"> • IP ADDRESS <u>239.2.0.1</u> • PORT 1024 to <u>49321</u> to 65535 (10670 is prohibited) 	<p>IP ADDRESS Enter the IP address for HD TRUNK TX.</p> <p>PORT Enter the port number for HD TRUNK TX.</p>
HD TRUNK AUDIO TX	<ul style="list-style-type: none"> • IP ADDRESS <u>239.3.0.1</u> • PORT 1024 to <u>49331</u> to 65535 (10670 is prohibited) 	<p>IP ADDRESS Enter the IP address for HD TRUNK AUDIO TX.</p> <p>PORT Enter the port number for HD TRUNK AUDIO TX.</p>

Item	Setting value	Setting details
MIC1 AUDIO TX	<ul style="list-style-type: none"> • IP ADDRESS <u>239.4.0.1</u> • PORT 1024 to 49341 to 65535 (10670 is prohibited) 	<p>IP ADDRESS Enter the IP address for MIC1 AUDIO TX.</p> <p>PORT Enter the port number for MIC1 AUDIO TX.</p>
MIC2 AUDIO TX	<ul style="list-style-type: none"> • IP ADDRESS <u>239.4.0.2</u> • PORT 1024 to 49342 to 65535 (10670 is prohibited) 	<p>IP ADDRESS Enter the IP address for MIC2 AUDIO TX.</p> <p>PORT Enter the port number for MIC2 AUDIO TX.</p>
INCOM1 AUDIO TX	<ul style="list-style-type: none"> • IP ADDRESS <u>239.5.0.1</u> • PORT 1024 to 49351 to 65535 (10670 is prohibited) 	<p>IP ADDRESS Enter the IP address for INCOM1 AUDIO TX.</p> <p>PORT Enter the port number for INCOM1 AUDIO TX.</p>
INCOM2 AUDIO TX	<ul style="list-style-type: none"> • IP ADDRESS <u>239.5.0.2</u> • PORT 1024 to 49352 to 65535 (10670 is prohibited) 	<p>IP ADDRESS Enter the IP address for INCOM2 AUDIO TX.</p> <p>PORT Enter the port number for INCOM2 AUDIO TX.</p>

SFP1(PRIMARY)RX

- Can be set when the AK-NP701 option board is attached.

Click [SFP1(PRIMARY)RX] in the Network settings screen [NETWORK].

Make network settings for the SFP1(PRIMARY) RX signal.

Confirm the settings with the [SET] button.

___ indicates factory default settings.

Item	Setting value	Setting details
RETURN1 VIDEO RX	<ul style="list-style-type: none"> • MULTICAST ADDRESS <u>239.11.0.1</u> • SOURCE ADDRESS <u>0.0.0.0</u> • PORT 1024 to 49411 to 65535 (10670 is prohibited) 	<p>MULTICAST ADDRESS Enter the multicast address for return images 1.</p> <p>SOURCE ADDRESS Enter the transmission source IP address for return images 1.</p> <p>PORT Enter the port number for return images 1.</p>
RETURN2 VIDEO RX	<ul style="list-style-type: none"> • MULTICAST ADDRESS <u>239.11.0.2</u> • SOURCE ADDRESS <u>0.0.0.0</u> • PORT 1024 to 49412 to 65535 (10670 is prohibited) 	<p>MULTICAST ADDRESS Enter the multicast address for return images 2.</p> <p>SOURCE ADDRESS Enter the transmission source IP address for return images 2.</p> <p>PORT Enter the port number for return images 2.</p>
RETURN3 VIDEO RX	<ul style="list-style-type: none"> • MULTICAST ADDRESS <u>239.11.0.3</u> • SOURCE ADDRESS <u>0.0.0.0</u> • PORT 1024 to 49413 to 65535 (10670 is prohibited) 	<p>MULTICAST ADDRESS Enter the multicast address for return images 3.</p> <p>SOURCE ADDRESS Enter the transmission source IP address for return images 3.</p> <p>PORT Enter the port number for return images 3.</p>
RETURN4 VIDEO RX	<ul style="list-style-type: none"> • MULTICAST ADDRESS <u>239.11.0.4</u> • SOURCE ADDRESS <u>0.0.0.0</u> • PORT 1024 to 49414 to 65535 (10670 is prohibited) 	<p>MULTICAST ADDRESS Enter the multicast address for return images 4.</p> <p>SOURCE ADDRESS Enter the transmission source IP address for return images 4.</p> <p>PORT Enter the port number for return images 4.</p>

Item	Setting value	Setting details
HD PROMPTER RX	<ul style="list-style-type: none"> • MULTICAST ADDRESS <u>239.12.0.1</u> • SOURCE ADDRESS <u>0.0.0.0</u> • PORT 1024 to 49421 to 65535 (10670 is prohibited) 	<p>MULTICAST ADDRESS Enter the multicast address for HD PROMPTER RX.</p> <p>SOURCE ADDRESS Enter the source IP address for HD PROMPTER RX.</p> <p>PORT Enter the port number for HD PROMPTER RX.</p>
HD PROMPTER AUDIO RX	<ul style="list-style-type: none"> • MULTICAST ADDRESS <u>239.13.0.1</u> • SOURCE ADDRESS <u>0.0.0.0</u> • PORT 1024 to 49431 to 65535 (10670 is prohibited) 	<p>MULTICAST ADDRESS Enter the multicast address for HD PROMPTER AUDIO RX.</p> <p>SOURCE ADDRESS Enter the source IP address for HD PROMPTER AUDIO RX.</p> <p>PORT Enter the port number for HD PROMPTER AUDIO RX.</p>
PGM1 AUDIO RX	<ul style="list-style-type: none"> • MULTICAST ADDRESS <u>239.14.0.1</u> • SOURCE ADDRESS <u>0.0.0.0</u> • PORT 1024 to 49441 to 65535 (10670 is prohibited) 	<p>MULTICAST ADDRESS Enter the multicast address for PGM1 AUDIO RX.</p> <p>SOURCE ADDRESS Enter the source IP address for PGM1 AUDIO RX.</p> <p>PORT Enter the port number for PGM1 AUDIO RX.</p>
PGM2 AUDIO RX	<ul style="list-style-type: none"> • MULTICAST ADDRESS <u>239.14.0.2</u> • SOURCE ADDRESS <u>0.0.0.0</u> • PORT 1024 to 49442 to 65535 (10670 is prohibited) 	<p>MULTICAST ADDRESS Enter the multicast address for PGM2 AUDIO RX.</p> <p>SOURCE ADDRESS Enter the source IP address for PGM2 AUDIO RX.</p> <p>PORT Enter the port number for PGM2 AUDIO RX.</p>
INCOM1 AUDIO RX	<ul style="list-style-type: none"> • MULTICAST ADDRESS <u>239.15.0.1</u> • SOURCE ADDRESS <u>0.0.0.0</u> • PORT 1024 to 49451 to 65535 (10670 is prohibited) 	<p>MULTICAST ADDRESS Enter the multicast address for INCOM1 AUDIO RX.</p> <p>SOURCE ADDRESS Enter the source IP address for INCOM1 AUDIO RX.</p> <p>PORT Enter the port number for INCOM1 AUDIO RX.</p>
INCOM2 AUDIO RX	<ul style="list-style-type: none"> • MULTICAST ADDRESS <u>239.15.0.2</u> • SOURCE ADDRESS <u>0.0.0.0</u> • PORT 1024 to 49452 to 65535 (10670 is prohibited) 	<p>MULTICAST ADDRESS Enter the multicast address for INCOM2 AUDIO RX.</p> <p>SOURCE ADDRESS Enter the source IP address for INCOM2 AUDIO RX.</p> <p>PORT Enter the port number for INCOM2 AUDIO RX.</p>
RETURN1 JPEG XS RX	<ul style="list-style-type: none"> • MULTICAST ADDRESS <u>239.16.0.1</u> • SOURCE ADDRESS <u>0.0.0.0</u> • PORT 1024 to 49461 to 65535 (10670 is prohibited) 	<p>MULTICAST ADDRESS Enter the multicast address for RETURN1 JPEG XS RX.</p> <p>SOURCE ADDRESS Enter the source IP address for RETURN1 JPEG XS RX.</p> <p>PORT Enter the port number for RETURN1 JPEG XS RX.</p>
RETURN2 JPEG XS RX	<ul style="list-style-type: none"> • MULTICAST ADDRESS <u>239.16.0.2</u> • SOURCE ADDRESS <u>0.0.0.0</u> • PORT 1024 to 49462 to 65535 (10670 is prohibited) 	<p>MULTICAST ADDRESS Enter the multicast address for RETURN2 JPEG XS RX.</p> <p>SOURCE ADDRESS Enter the source IP address for RETURN2 JPEG XS RX.</p> <p>PORT Enter the port number for RETURN2 JPEG XS RX.</p>

Item	Setting value	Setting details
RETURN3 JPEG XS RX	<ul style="list-style-type: none"> MULTICAST ADDRESS <u>239.16.0.3</u> SOURCE ADDRESS <u>0.0.0.0</u> PORT 1024 to 49463 to 65535 (10670 is prohibited) 	<p>MULTICAST ADDRESS Enter the multicast address for RETURN3 JPEG XS RX.</p> <p>SOURCE ADDRESS Enter the source IP address for RETURN3 JPEG XS RX.</p> <p>PORT Enter the port number for RETURN3 JPEG XS RX.</p>
RETURN4 JPEG XS RX	<ul style="list-style-type: none"> MULTICAST ADDRESS <u>239.16.0.4</u> SOURCE ADDRESS <u>0.0.0.0</u> PORT 1024 to 49464 to 65535 (10670 is prohibited) 	<p>MULTICAST ADDRESS Enter the multicast address for RETURN4 JPEG XS RX.</p> <p>SOURCE ADDRESS Enter the source IP address for RETURN4 JPEG XS RX.</p> <p>PORT Enter the port number for RETURN4 JPEG XS RX.</p>

SFP2(SECONDARY)

- Can be set when the AK-NP701 option board is attached.

Click [SFP2(SECONDARY)] in the Network settings screen [NETWORK].

Make network settings for the [SFP+/SFP28] slot 2 (SFP2(SECONDARY)) for MoIP input/output.

Confirm the settings with the [SET] button.

The following information is required to configure network settings. Consult your network administrator or Internet service provider.

- IP address
- Port
- Subnet mask
- Default gateway (when using a gateway server or router)

___ indicates factory default settings.

Item	Setting value	Setting details
DHCP	ON <u>OFF</u>	Select the method for setting the SFP2(SECONDARY) IP addresses.
IP ADDRESS	<u>192.168.0.51</u>	When not using the DHCP function, enter the SFP2(SECONDARY) IP addresses. Enter so that the address does not duplicate the IP addresses of the personal computer or other network cameras.
PORT	1024 to <u>49301</u> to 65535 (10670 is prohibited)	Enter the SFP2(SECONDARY) port numbers.
SUBNET MASK	<u>255.255.255.0</u>	When not using the DHCP function, enter the SFP2(SECONDARY) subnet masks.
DEFAULT GATEWAY	<u>192.168.0.1</u>	When not using the DHCP function, set the SFP2(SECONDARY) default gateways.
MAC ADDRESS	Display only	Display the SFP2(SECONDARY) MAC addresses.

SFP2(SECONDARY)TX

- Can be set when the AK-NP701 option board is attached.

Click [SFP2(SECONDARY)TX] in the Network settings screen [NETWORK].

Make network settings for the SFP2(SECONDARY) TX signal.

Confirm the settings with the [SET] button.

___ indicates factory default settings.

Item	Setting value	Setting details
MAIN VIDEO TX	<ul style="list-style-type: none"> IP ADDRESS <u>239.21.0.1</u> PORT 1024 to 49511 to 65535 (10670 is prohibited) 	<p>IP ADDRESS Enter the IP address for MAIN VIDEO TX.</p> <p>PORT Enter the port number for MAIN VIDEO TX.</p>
JPEG XS TX	<ul style="list-style-type: none"> IP ADDRESS <u>239.21.0.10</u> PORT 1024 to 49561 to 65535 (10670 is prohibited) 	<p>IP ADDRESS Enter the IP address for JPEG XS TX.</p> <p>PORT Enter the port number for JPEG XS TX.</p>

Item	Setting value	Setting details
MONITOR VIDEO TX	<ul style="list-style-type: none"> IP ADDRESS <u>239.21.0.11</u> PORT 1024 to 49512 to 65535 (10670 is prohibited) 	<p>IP ADDRESS Enter the IP address for MONITOR VIDEO TX.</p> <p>PORT Enter the port number for MONITOR VIDEO TX.</p>
HD TRUNK TX	<ul style="list-style-type: none"> IP ADDRESS <u>239.22.0.1</u> PORT 1024 to 49521 to 65535 (10670 is prohibited) 	<p>IP ADDRESS Enter the IP address for HD TRUNK TX.</p> <p>PORT Enter the port number for HD TRUNK TX.</p>
HD TRUNK AUDIO TX	<ul style="list-style-type: none"> IP ADDRESS <u>239.23.0.1</u> PORT 1024 to 49531 to 65535 (10670 is prohibited) 	<p>IP ADDRESS Enter the IP address for HD TRUNK AUDIO TX.</p> <p>PORT Enter the port number for HD TRUNK AUDIO TX.</p>
MIC1 AUDIO TX	<ul style="list-style-type: none"> IP ADDRESS <u>239.24.0.1</u> PORT 1024 to 49541 to 65535 (10670 is prohibited) 	<p>IP ADDRESS Enter the IP address for MIC1 AUDIO TX.</p> <p>PORT Enter the port number for MIC1 AUDIO TX.</p>
MIC2 AUDIO TX	<ul style="list-style-type: none"> IP ADDRESS <u>239.24.0.2</u> PORT 1024 to 49542 to 65535 (10670 is prohibited) 	<p>IP ADDRESS Enter the IP address for MIC2 AUDIO TX.</p> <p>PORT Enter the port number for MIC2 AUDIO TX.</p>
INCOM1 AUDIO TX	<ul style="list-style-type: none"> IP ADDRESS <u>239.25.0.1</u> PORT 1024 to 49551 to 65535 (10670 is prohibited) 	<p>IP ADDRESS Enter the source IP address for INCOM1 AUDIO TX.</p> <p>PORT Enter the port number for INCOM1 AUDIO TX.</p>
INCOM2 AUDIO TX	<ul style="list-style-type: none"> IP ADDRESS <u>239.25.0.2</u> PORT 1024 to 49552 to 65535 (10670 is prohibited) 	<p>IP ADDRESS Enter the source IP address for INCOM2 AUDIO TX.</p> <p>PORT Enter the port number for INCOM2 AUDIO TX.</p>

SFP2(SECONDARY)RX

- Can be set when the AK-NP701 option board is attached.

Click [SFP2(SECONDARY)RX] in the Network settings screen [NETWORK].

Make network settings for the SFP2(SECONDARY) RX signal.

Confirm the settings with the [SET] button.

___ indicates factory default settings.

Item	Setting value	Setting details
RETURN1 VIDEO RX	<ul style="list-style-type: none"> MULTICAST ADDRESS <u>239.31.0.1</u> SOURCE ADDRESS <u>0.0.0.0</u> PORT 1024 to 49611 to 65535 (10670 is prohibited) 	<p>MULTICAST ADDRESS Enter the multicast address for return images 1.</p> <p>SOURCE ADDRESS Enter the transmission source IP address for return images 1.</p> <p>PORT Enter the port number for return images 1.</p>
RETURN2 VIDEO RX	<ul style="list-style-type: none"> MULTICAST ADDRESS <u>239.31.0.2</u> SOURCE ADDRESS <u>0.0.0.0</u> PORT 1024 to 49612 to 65535 (10670 is prohibited) 	<p>MULTICAST ADDRESS Enter the multicast address for return images 2.</p> <p>SOURCE ADDRESS Enter the transmission source IP address for return images 2.</p> <p>PORT Enter the port number for return images 2.</p>

Item	Setting value	Setting details
RETURN3 VIDEO RX	<ul style="list-style-type: none"> MULTICAST ADDRESS <u>239.31.0.3</u> SOURCE ADDRESS <u>0.0.0.0</u> PORT 1024 to 49613 to 65535 (10670 is prohibited) 	<p>MULTICAST ADDRESS Enter the multicast address for return images 3.</p> <p>SOURCE ADDRESS Enter the transmission source IP address for return images 3.</p> <p>PORT Enter the port number for return images 3.</p>
RETURN4 VIDEO RX	<ul style="list-style-type: none"> MULTICAST ADDRESS <u>239.31.0.4</u> SOURCE ADDRESS <u>0.0.0.0</u> PORT 1024 to 49614 to 65535 (10670 is prohibited) 	<p>MULTICAST ADDRESS Enter the multicast address for return images 4.</p> <p>SOURCE ADDRESS Enter the transmission source IP address for return images 4.</p> <p>PORT Enter the port number for return images 4.</p>
HD PROMPTER RX	<ul style="list-style-type: none"> MULTICAST ADDRESS <u>239.32.0.1</u> SOURCE ADDRESS <u>0.0.0.0</u> PORT 1024 to 49621 to 65535 (10670 is prohibited) 	<p>MULTICAST ADDRESS Enter the multicast address for HD PROMPTER RX.</p> <p>SOURCE ADDRESS Enter the source IP address for HD PROMPTER RX.</p> <p>PORT Enter the port number for HD PROMPTER RX.</p>
HD PROMPTER AUDIO RX	<ul style="list-style-type: none"> MULTICAST ADDRESS <u>239.33.0.1</u> SOURCE ADDRESS <u>0.0.0.0</u> PORT 1024 to 49631 to 65535 (10670 is prohibited) 	<p>MULTICAST ADDRESS Enter the multicast address for HD PROMPTER AUDIO RX.</p> <p>SOURCE ADDRESS Enter the source IP address for HD PROMPTER AUDIO RX.</p> <p>PORT Enter the port number for HD PROMPTER AUDIO RX.</p>
PGM1 AUDIO RX	<ul style="list-style-type: none"> MULTICAST ADDRESS <u>239.34.0.1</u> SOURCE ADDRESS <u>0.0.0.0</u> PORT 1024 to 49641 to 65535 (10670 is prohibited) 	<p>MULTICAST ADDRESS Enter the multicast address for PGM1 AUDIO RX.</p> <p>SOURCE ADDRESS Enter the source IP address for PGM1 AUDIO RX.</p> <p>PORT Enter the port number for PGM1 AUDIO RX.</p>
PGM2 AUDIO RX	<ul style="list-style-type: none"> MULTICAST ADDRESS <u>239.34.0.2</u> SOURCE ADDRESS <u>0.0.0.0</u> PORT 1024 to 49642 to 65535 (10670 is prohibited) 	<p>MULTICAST ADDRESS Enter the multicast address for PGM2 AUDIO RX.</p> <p>SOURCE ADDRESS Enter the source IP address for PGM2 AUDIO RX.</p> <p>PORT Enter the port number for PGM2 AUDIO RX.</p>
INCOM1 AUDIO RX	<ul style="list-style-type: none"> MULTICAST ADDRESS <u>239.35.0.1</u> SOURCE ADDRESS <u>0.0.0.0</u> PORT 1024 to 49651 to 65535 (10670 is prohibited) 	<p>MULTICAST ADDRESS Enter the multicast address for INCOM1 AUDIO RX.</p> <p>SOURCE ADDRESS Enter the source IP address for INCOM1 AUDIO RX.</p> <p>PORT Enter the port number for INCOM1 AUDIO RX.</p>
INCOM2 AUDIO RX	<ul style="list-style-type: none"> MULTICAST ADDRESS <u>239.35.0.2</u> SOURCE ADDRESS <u>0.0.0.0</u> PORT 1024 to 49652 to 65535 (10670 is prohibited) 	<p>MULTICAST ADDRESS Enter the multicast address for INCOM2 AUDIO RX.</p> <p>SOURCE ADDRESS Enter the source IP address for INCOM2 AUDIO RX.</p> <p>PORT Enter the port number for INCOM2 AUDIO RX.</p>

Item	Setting value	Setting details
RETURN1 JPEG XS RX	<ul style="list-style-type: none"> MULTICAST ADDRESS <u>239.36.0.1</u> SOURCE ADDRESS <u>0.0.0.0</u> PORT 1024 to 49661 to 65535 (10670 is prohibited) 	<p>MULTICAST ADDRESS Enter the multicast address for RETURN1 JPEG XS RX.</p> <p>SOURCE ADDRESS Enter the source IP address for RETURN1 JPEG XS RX.</p> <p>PORT Enter the port number for RETURN1 JPEG XS RX.</p>
RETURN2 JPEG XS RX	<ul style="list-style-type: none"> MULTICAST ADDRESS <u>239.36.0.2</u> SOURCE ADDRESS <u>0.0.0.0</u> PORT 1024 to 49662 to 65535 (10670 is prohibited) 	<p>MULTICAST ADDRESS Enter the multicast address for RETURN2 JPEG XS RX.</p> <p>SOURCE ADDRESS Enter the source IP address for RETURN2 JPEG XS RX.</p> <p>PORT Enter the port number for RETURN2 JPEG XS RX.</p>
RETURN3 JPEG XS RX	<ul style="list-style-type: none"> MULTICAST ADDRESS <u>239.36.0.3</u> SOURCE ADDRESS <u>0.0.0.0</u> PORT 1024 to 49663 to 65535 (10670 is prohibited) 	<p>MULTICAST ADDRESS Enter the multicast address for RETURN3 JPEG XS RX.</p> <p>SOURCE ADDRESS Enter the source IP address for RETURN3 JPEG XS RX.</p> <p>PORT Enter the port number for RETURN3 JPEG XS RX.</p>
RETURN4 JPEG XS RX	<ul style="list-style-type: none"> MULTICAST ADDRESS <u>239.36.0.4</u> SOURCE ADDRESS <u>0.0.0.0</u> PORT 1024 to 49664 to 65535 (10670 is prohibited) 	<p>MULTICAST ADDRESS Enter the multicast address for RETURN4 JPEG XS RX.</p> <p>SOURCE ADDRESS Enter the source IP address for RETURN4 JPEG XS RX.</p> <p>PORT Enter the port number for RETURN4 JPEG XS RX.</p>

NMOS SETTING

- Can be set when the AK-NP701 option board is attached.

Click [NMOS SETTING] in the Network settings screen [NETWORK].

Make NMOS related network settings.

Confirm the settings with the [SET] button.

___ indicates factory default settings.

Item	Setting value	Setting details
NMOS CONTROL	ON OFF	Enables/disables the NMOS function.
STATUS	UNREGISTERD REGISTERING REGISTERED P2P MODE (Display only)	Displays the NMOS operation status, such as RDS connection status.
PORT(IS-04)	1024 to <u>50040</u> to 65535	Sets the port number on the camera for IS-04 Node API.
PORT(IS-05)	1024 to <u>50050</u> to 65535	Sets the port number on the camera for IS-05 Connection API.
RDS IP ADDRESS	Display only	Displays the discovered IP address.
RDS PORT	Display only	Displays the port number automatically discovered.
LABEL SETTING	AUTO MANUAL	<p>AUTO The LABEL PREFIX cannot be changed. It is fixed to UCU700_**** ("****" is the last four digits of the MAC address).</p> <p>MANUAL Text can be set in LABEL PREFIX.</p>
LABEL PREFIX	UCU700_**** ("****" is the last four digits of the MAC address)	Sets the prefix appended which is shared with NMOS resource names on this unit.
DISCOVERY	<u>uniDNS</u> mDNS	Sets the method for NMOS resource discovery.

NDI/SRT SETTING

- Can be set when the AK-NP703 option board is attached.

Click [NDI/SRT SETTING] in the Network settings screen [NETWORK].

Make network settings for NDI/SRT.

Confirm the settings with the [SET] button.

The following information is required to configure network settings. Consult your network administrator or Internet service provider.

- IP address
- Port
- Subnet mask
- Default gateway (when using a gateway server or router)

___ indicates factory default settings.

Item	Setting value	Setting details
DHCP	ON OFF	Select the method for setting the IP address for NDI/SRT.
IP ADDRESS	<u>192.168.0.52</u>	When not using the DHCP function, enter the NDI/SRT IP address. Enter so that the address does not duplicate the IP addresses of the personal computer or other network cameras.
PORT	1024 to <u>49302</u> to 65535 (10670 is prohibited)	Enter the NDI/SRT port number.
SUBNET MASK	<u>255.255.255.0</u>	When not using the DHCP function, enter the NDI/SRT subnet mask.
DEFAULT GATEWAY	<u>192.168.0.1</u>	When not using the DHCP function, set the NDI/SRT default gateway.
MAC ADDRESS	Display only	Display the MAC address for NDI/SRT.

DNS SETTING

- Can be set when the AK-NP703 option board is attached.

Click [DNS SETTING] in the Network settings screen [NETWORK].

Makes settings for DNS.

Confirm the settings with the [SET] button.

The following information is required to configure network settings. Consult your network administrator or Internet service provider.

- Primary server address, secondary server address, and domain for DNS (when using DNS)

___ indicates factory default settings.

Item	Setting value	Setting details
DNS	<ul style="list-style-type: none"> • DNS <u>MANUAL</u> AUTO • PRIMARY SERVER ADDRESS <u>0.0.0.0</u> • SECONDARY SERVER ADDRESS <u>0.0.0.0</u> • DOMAIN The default value is blank 	<p>DNS Sets whether the DNS server address is to be acquired automatically (AUTO), or to be input manually (MANUAL).</p> <p>PRIMARY SERVER ADDRESS SECONDARY SERVER ADDRESS DOMAIN When using [MANUAL] for [DNS], enter the IP address for the DNS server.</p> <ul style="list-style-type: none"> • Consult the system administrator regarding the DNS server information.

HTTPS

Click [HTTPS] in the Network settings screen [NETWORK].

Makes settings for the HTTPS function.

The setting is confirmed with the [SET] button.

Refer to "HTTPS settings [HTTPS]" for information on how to set HTTPS.

___ indicates factory default settings.

Item	Setting value	Setting details
CRT KEY GENERATE	-	A CRT key (SSL encryption key) is generated by HTTPS. Generation of the CRT key is performed with the dialog displayed when you click the [EXECUTE] button. ➔ "Generating a CRT key (SSL encryption key) [CRT KEY GENERATE]" (see page 116)
SELF-SIGNED CERTIFICATE - GENERATE	-	A self-signed security certificate is generated by HTTPS. (Self-signed Certificate) Generation of the self-signed certificate (security certificate) is performed with the dialog displayed when you click the [EXECUTE] button. ➔ "Generating a self-signed certificate (security certificate) [SELF-SIGNED CERTIFICATE - GENERATE]" (see page 117)
SELF-SIGNED CERTIFICATE - INFORMATION	-	This displays information relating to the self-signed certificate (security certificate). When you click the [CONFIRM] button, the information registered in the generated self-signed certificate (security certificate) is displayed in a dialog. Click the [DELETE] button to delete the generated self-signed certificate (security certificate).
CA CERTIFICATE - GENERATE CERTIFICATE SIGNING REQUEST	-	When using a security certificate issued by the Certificate Authority (CA) as a security certificate for HTTPS, a Certificate Signing Request (CSR) is generated for application to the Certificate Authority (CA). Generation of the Certificate Signing Request (CSR) is performed with the dialog displayed when you click the [EXECUTE] button. ➔ "Generating a Certificate Signing Request (CSR) [CA CERTIFICATE - GENERATE CERTIFICATE SIGNING REQUEST]" (see page 119)
CA CERTIFICATE - CA CERTIFICATE INSTALL	-	This displays information relating to server certificates (security certificates) issued by the Certificate Authority (CA), which are to be or are already installed. In the [File Open] dialog, which is displayed by clicking the [SELECT] button, select the file of the server certificate (security certificate) issued by the Certificate Authority (CA) and click the [EXECUTE] button to install the server certificate (security certificate). If the server certificate (security certificate) is installed, its file name will be displayed. ➔ "Installing a Server Certificate [CA CERTIFICATE - CA CERTIFICATE INSTALL]" (see page 120)
CA CERTIFICATE - INFORMATION	-	This displays information relating to the server certificate (security certificate). When you click the [CONFIRM] button, the information registered in the installed server certificate (security certificate) is displayed in a dialog. If the server certificate (security certificate) is not installed, the content of the generated Certificate Signing Request (CSR) is displayed. Click the [DELETE] button to delete the installed server certificate (security certificate).
CONNECTION	<u>HTTP</u> HTTPS	This sets the method to connect to the unit.
HTTPS MODE	TLS1.2/1.3 <u>TLS1.2</u> TLS1.3	This sets the encryption protocol when accessing the CCU with HTTPS.

NOTE

- To delete an enabled server certificate (security certificate), confirm that there is a backup to the said certificate in your personal computer or recording media. A server certificate (security certificate) will be needed to reinstall it.

HTTPS settings [HTTPS]

This encrypts access to the CCU and sets HTTPS to improve communication safety. Setting HTTPS is performed by following the procedures below. The setting is confirmed with the [SET] button.

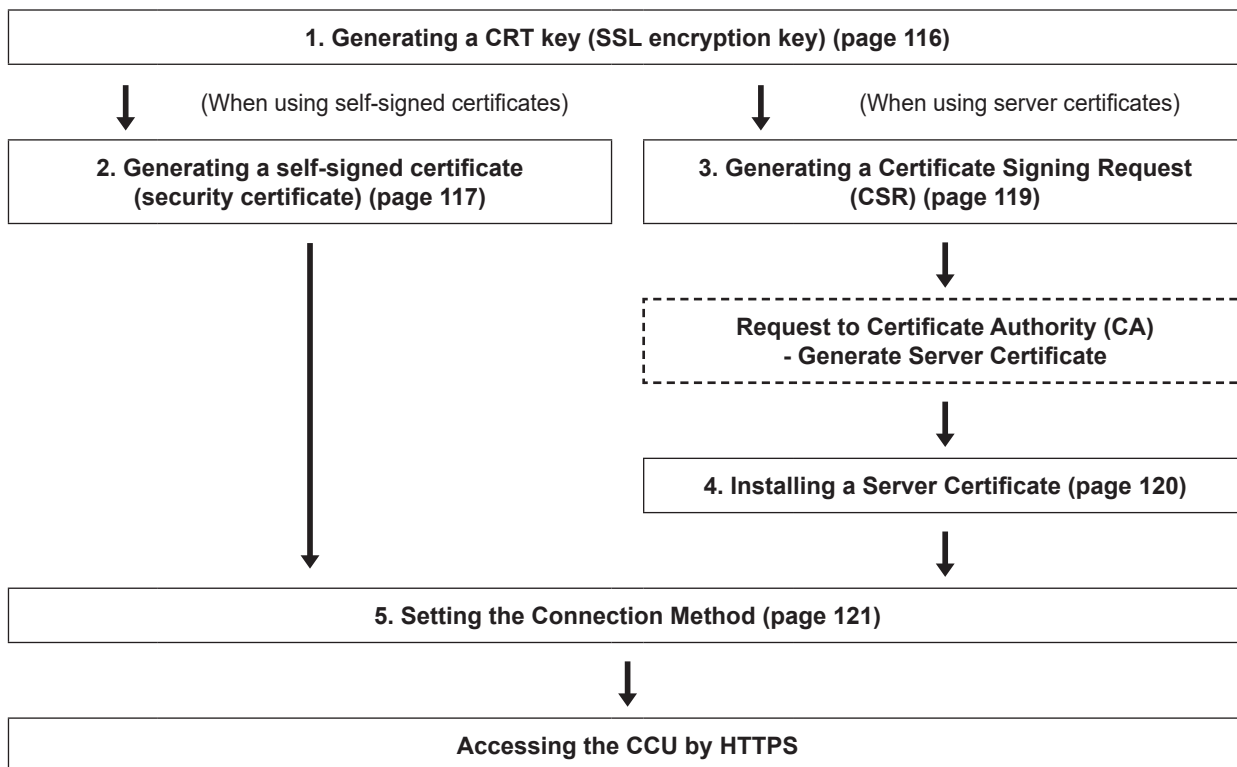
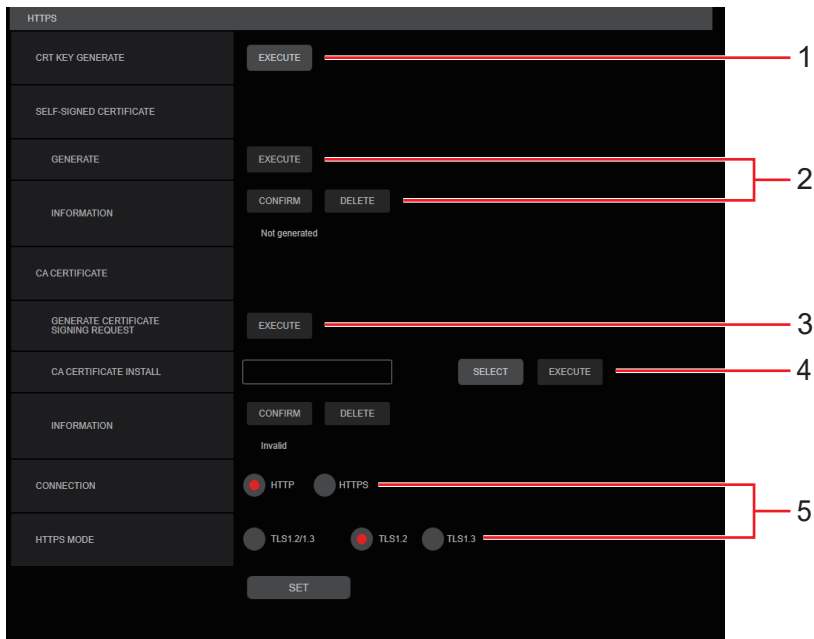

NOTE

- When using a server certificate, the process from applying to the Certificate Authority (CA) to issuing a server certificate must be performed between customers and the Certificate Authority (CA).
- Use either a self-signed certificate or server certificate. When simultaneously generating a self-signed certificate and installing a server certificate, this unit will prioritize the server certificate.

Generating a CRT key (SSL encryption key) [CRT KEY GENERATE]

NOTE

- A CRT key cannot be generated when self-signed certificates and server certificates are enabled.
- The size of the key that can be used by the Certificate Authority (CA) differs when using a server certificate. Confirm in advance the size of the key that can be used.
- Generating a CRT key takes about 1 minute for 1024 bit and about 2 minutes for 2048 bit. Do not operate the web browser until CRT key generation is complete. Image display and communication speed may reduce while generating a CRT key.

1. Click the [EXECUTE] button in [CRT KEY GENERATE].

The [Current CRT key] dialog is displayed.

Current CRT Key	
CRT Key	
RSA key size	
Last modified	Not generated History
CRT key generate	
RSA key size	<input type="radio"/> 1024bit <input checked="" type="radio"/> 2048bit Execute
	*Generating a CRT key takes around 2 minutes.
	Close

2. The size of the generated CRT key is selected from [1024bit]/[2048bit] in [CRT key generate] – [RSA key size].

NOTE

- When using a server certificate, the RSA key size must be in accordance with the demands of the Certificate Authority (CA) which will be applied to.

3. Click the [Execute] button.

CRT key generation starts.

When CRT key generation stops, the size of the CRT key generated by the [Current CRT key] and the date and time generation concluded will be displayed.

NOTE

- Perform procedures 1 to 3 to change (update) the generated CRT key. Because the CRT key, self-signed certificate and server certificate are enabled as a set, it will be necessary to once again generate a self-signed certificate or apply for a server certificate when the CRT key is changed.
- When the CRT key is changed, previous CRT keys are historically managed one at a time. Clicking the [History] button in the [CRT key] of the [Current CRT key] dialog displays the [Previous CRT key] dialog, allowing confirmation of the key size and the date and time generation was completed. Clicking the [Apply] button in [Previous CRT key] allows the previous CRT key to be switched to the current CRT key.

Previous CRT key	
History	
RSA key size	2048bit
Last modified	2023/01/01 00:00:00 Apply
	Close

Generating a self-signed certificate (security certificate) [SELF-SIGNED CERTIFICATE - GENERATE]

NOTE

- A self-signed certificate cannot be generated when a CRT key has not been generated.

1. Click the [EXECUTE] button in [SELF-SIGNED CERTIFICATE] - [GENERATE].

[Self-signed Certificate - Generate] is displayed.

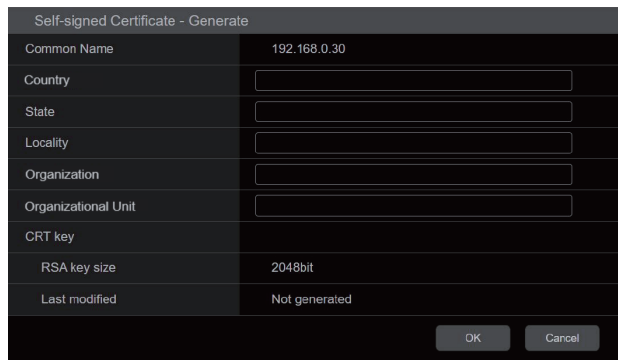

Self-signed Certificate - Generate	
Common Name	192.168.0.30
Country	<input type="text"/>
State	<input type="text"/>
Locality	<input type="text"/>
Organization	<input type="text"/>
Organizational Unit	<input type="text"/>
CRT key	
RSA key size	2048bit
Last modified	Not generated
<input type="button" value="OK"/> <input type="button" value="Cancel"/>	

2. Input information relating to the certificate to be generated.

Items to be entered are as follows.

Item	Description	Maximum number of characters
Common Name	Sets a fixed CCU IP address.	
Country	Inputs the country code. (can be left blank)	2 characters: country code
State	Inputs the name of the state. (can be left blank)	128 characters
Locality	Inputs the name of the city. (can be left blank)	128 characters
Organization	Inputs the name of the organization. (can be left blank)	64 characters
Organizational Unit	Inputs the name of the organizational unit. (can be left blank)	64 characters
CRT key	Displays the size of the current CRT key and the date and time generation was completed.	

NOTE

- Characters that can be input for [Common Name], [Country], [State], [Locality], [Organization], [Organizational Unit] are 0 to 9, A to Z, a to z, and the following symbols: - . _ + ().
- When connecting the CCU to the Internet, set the address or host name to be accessed from the Internet in [Common Name]. In this case, when accessing the CCU locally, a security warning screen is displayed every time the CCU is accessed even when a security certificate is installed.
- When inputting the IPv6 address in [Common Name], surround the address with [].
e.g. [2001:db8::10]

3. Click the [OK] button after inputting the address.

A self-signed certificate is generated.



- Information relating to the generated self-signed certificate is displayed in [SELF-SIGNED CERTIFICATE] - [INFORMATION]. The following is displayed depending on the status of the self-signed security certificate.

Displayed content	Description
Not generated	When the self-signed certificate is not generated
Invalid (Reason: CA Certificate installed)	When the self-signed certificate is already generated and the server certificate is already installed <ul style="list-style-type: none"> The server certificate is enabled in this case.
[Common Name] of self-signed certificate	When the self-signed certificate is already generated and enabled

- When the [CONFIRM] button is clicked, the registered content of the generated self-signed certificate (security certificate) is displayed in the [Self-signed Certificate - Confirm] dialog.

Self-signed Certificate - Confirm	
Common Name	192.168.0.30
Country	
State	
Locality	
Organization	
Organizational Unit	
CRT key	
RSA key size	2048bit
Last modified	2023/01/01 00:00:00
Close	

- Click the [DELETE] button to delete the generated self-signed certificate (security certificate).
- When [HTTPS] is selected in [CONNECTION], the self-signed certificate (security certificate) cannot be deleted.

Generating a Certificate Signing Request (CSR) [CA CERTIFICATE - GENERATE CERTIFICATE SIGNING REQUEST]

NOTE

- A certificate signing request (CSR) cannot be generated if a CRT key has not been generated.
- To generate a certificate signing request (CSR), perform the following settings in advance in the Internet options of the Control Panel. Perform the following settings in [Control Panel] - [Internet Options] - [Security] tab.
 - Register the CCU as a "Trusted Site".
 - In [Level Customize], go to [File Download] from [Download] and set to [Enable].

1. Click the [EXECUTE] button in [CA CERTIFICATE - GENERATE CERTIFICATE SIGNING REQUEST].

The [CA Certificate - Generate Certificate Signing Request] dialog is displayed.

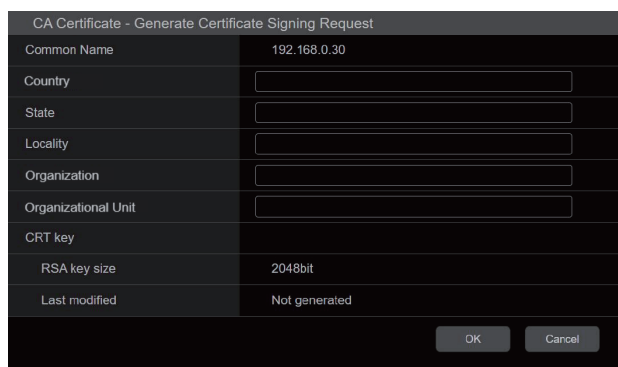

CA Certificate - Generate Certificate Signing Request	
Common Name	192.168.0.30
Country	<input type="text"/>
State	<input type="text"/>
Locality	<input type="text"/>
Organization	<input type="text"/>
Organizational Unit	<input type="text"/>
CRT key	
RSA key size	2048bit
Last modified	Not generated
<input type="button" value="OK"/> <input type="button" value="Cancel"/>	

2. Input information relating to the certificate to be generated.

Items to be entered are as follows.

Item	Description	Maximum number of characters
Common Name	Sets a fixed CCU IP address.	
Country	Inputs the country code.	2 characters: country code
State	Inputs the name of the state.	128 characters
Locality	Inputs the name of the city.	128 characters
Organization	Inputs the name of the organization.	64 characters
Organizational Unit	Inputs the name of the organizational unit.	64 characters
CRT key	Displays the size of the current CRT key and the date and time generation was completed.	

NOTE

- When using a server certificate, the information to be input must be in accordance with the demands of the Certificate Authority (CA), which will be applied to.
- Characters that can be input for [Common Name], [Country], [State], [Locality], [Organization], [Organizational Unit] are 0 to 9, A to Z, a to z, and the following symbols: - . _ + ().

3. Click the [OK] button after inputting the address.

The [Save As] dialog is displayed.

4. In the [Save As] dialog, assign a file name to the Certificate Signing Request (CSR) and save it in personal computer.

Apply to the Certificate Authority (CA) using the saved Certificate Signing Request (CSR).

NOTE

- A server certificate is issued for both the generated Certificate Signing Request (CSR) and CRT key. The issued server certificate can no longer be used when generating/updating the CRT key after applying to the Certificate Authority (CA).
- The Certificate Signing Request (CSR) generated by this unit is in a PEM format.

Installing a Server Certificate [CA CERTIFICATE - CA CERTIFICATE INSTALL]

NOTE

- A server certificate (security certificate) cannot be installed if a Certificate Signing Request (CSR) has not been generated.
- The server certificate must have been issued by the Certificate Authority (CA) in order to install it.

1. Click the [SELECT] button in [CA CERTIFICATE - CA CERTIFICATE INSTALL].

The [Open File] dialog is displayed.

2. Select the server certificate file and click [Open]. Then click the [Execute] button.

The server certificate is installed.

NOTE

- The name of the host registered to the installed server certificate is displayed in [CA CERTIFICATE] - [INFORMATION]. The following is also displayed depending on the status of the server certificate.

Displayed content	Description
Invalid	When the server certificate is not installed
[Common Name] of server certificate	When the server certificate is already installed and enabled
Expired	When the effective period of the server certificate has expired

- When the [CONFIRM] button is clicked, the content of the installed server certificate (security certificate) is displayed in the [CA Certificate - Confirm] dialog. (An asterisk is displayed in the [Organizational Unit] field only.)

CA Certificate - Confirm	
Common Name	192.168.0.30
Country	
State	
Locality	
Organization	
Organizational Unit	
CRT key	
RSA key size	2048bit
Last modified	2023/01/01 00:00:00
Close	

- Click the [DELETE] button to delete the installed server certificate (security certificate).
- When [HTTPS] is selected in [CONNECTION], the server certificate (security certificate) cannot be deleted.
- Perform STEP 1 to STEP 2 to update a server certificate.
- To delete an enabled server certificate (security certificate), confirm that there is a backup to the said certificate in your personal computer or recording media. A server certificate (security certificate) will be needed to reinstall it.
- The HTTPS function can no longer be used when the effective period of the server certificate has expired. In such a case, the connection method is changed to HTTP when the unit is restarted. Update the server certificate before its effective period expires.
- The effective period of the server certificate can be confirmed by double-clicking the server certificate file issued by the Certificate Authority (CA).

Setting the Connection Method [CONNECTION]

1. Set the method to access the CCU in [CONNECTION].

HTTP: Only HTTP connection is possible.

HTTPS: Only HTTPS connection is possible.



- When using an HTTPS connection, network connection with the AK-HRP1010, AK-HRP1015, and AK-MSU1000 will be disabled.

2. Set the encryption protocol used with HTTPS in [HTTPS MODE].

TLS1.2/1.3: Connection with TLS1.2/1.3 is possible.

TLS1.3: Connection with TLS1.3 is possible.

TLS1.2: Connection with TLS1.2 is possible.

3. Click the [SET] button.

The CCU restarts and access to the CCU via HTTPS is enabled.



- This unit will restart if the connection method is changed.
- **Using a self-signed certificate**
A warning screen is displayed when accessing the CCU by HTTPS for the first time. Install the self-signed certificate (security certificate) in your personal computer in accordance with the screen instructions.
➡ "Install the security certificate" (see page 122)
- **Using a server certificate**
Install the Certificate Authority (CA) root certificate or intermediate certificate in your web browser in advance. Follow the Certificate Authority (CA) procedures to acquire and install root certificates and intermediate certificates.
- When accessing the CCU by HTTPS, the image display speed and frame rate of the moving image may reduce.
- When accessing the CCU by HTTPS, it may take some time for the images to be displayed.
- When accessing the CCU by HTTPS, images may be disturbed and sound may be interrupted.
- The maximum number of CCUs that can be connected simultaneously depends on the maximum image size and distribution format.

Accessing the CCU by HTTPS

1. Launch the web browser in your personal computer.

2. Input the CCU's IP address in the address bar of the web browser.

Input address: https://192.168.0.10/



- If this unit is within a local network, make the settings for the proxy server from [Control Panel] - [Internet Options] so that the proxy server is not used for the local address.

3. Press the [Enter] key.

The security certificate is installed when the security warning screen is displayed.

➡ "Install the security certificate" (see page 122)

Before the next screen appears, the user name and password input screen is displayed.



- When HTTPS is used, screens may be displayed slower.

Install the security certificate

When using HTTPS to access the CCU, the security warning screen will be displayed if the security certificate of the said CCU has not been installed in your personal computer. To prevent this warning screen being displayed, the security certificate must be installed in accordance with the following procedures. If it is not installed, the security warning screen will be displayed every time the CCU is accessed.

NOTE

- The security certificate will be installed to your personal computer based on the content set for [Common Name]. The content set for the "Host Name" must therefore match that set for the address/host name used to access the CCU. If the content differs, a security warning screen will be displayed every time the CCU is accessed.
- A security warning screen will be displayed if the CCU address/host name is changed even when a security certificate has been installed. Reinstall the security certificate.
- When connecting the CCU to the Internet, set the address or host name to be accessed from the Internet in [Common Name]. In this case, when accessing the CCU locally, a security warning screen is displayed every time the CCU is accessed even when a security certificate is installed.
- When the security certificate is correctly installed, an icon of the key will be displayed in the address bar of the web browser accessing the CCU.

1. Accessing the CCU by HTTPS.
2. When the security warning screen is displayed, click [Continue to this website (not recommended)].

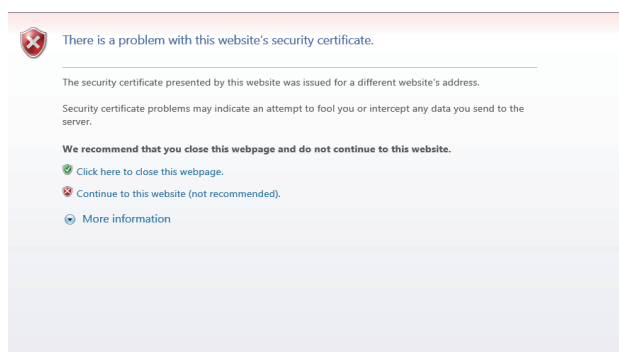

NOTE

- When the above screen is displayed after accessing a device apart from the CCU or a website, there may be a security problem, so check this carefully.

3. Click [Certificate error] in the URL and then click [View certificates].

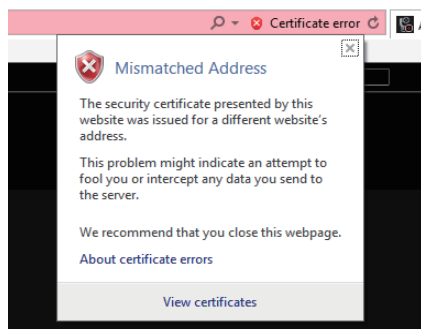

4. Click [Install Certificate...].

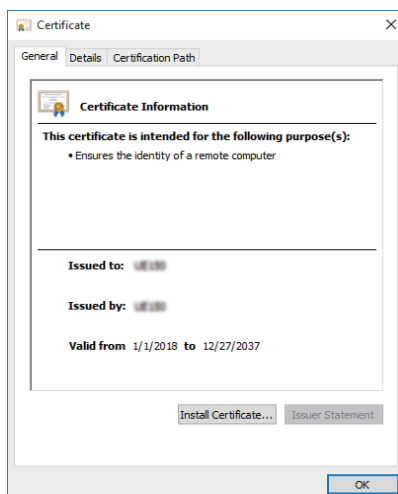

NOTE

- If [Install Certificate...] is not displayed, close Microsoft Edge and restart it by selecting [Run as Administrator]. Right-click on [Start] - [Microsoft Edge] and click [More] - [Execute as Administrator].

5. Click [Next], which is displayed in the certificate import wizard.

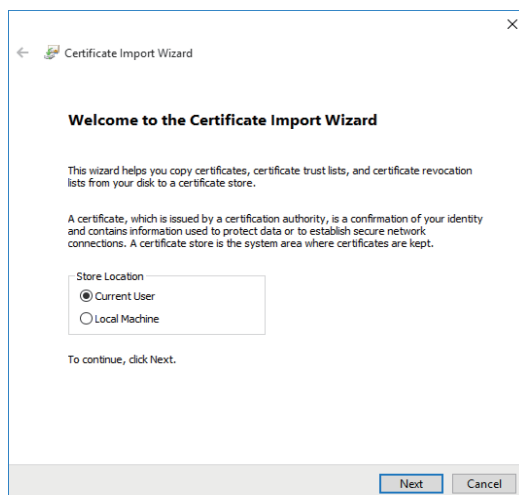

6. Select [Place all certificates in the following store] and click [Browse...].

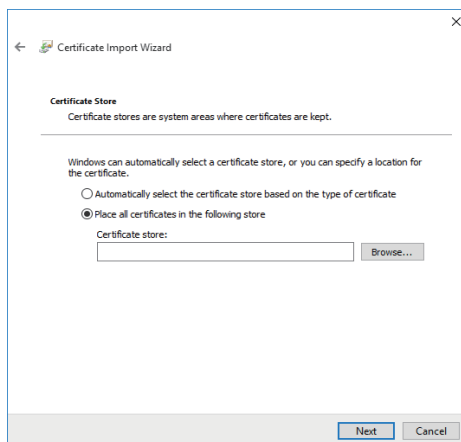

7. Select [Trusted Root Certification Authorities] and click [OK].

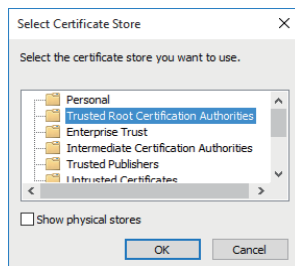

8. Click [Next].

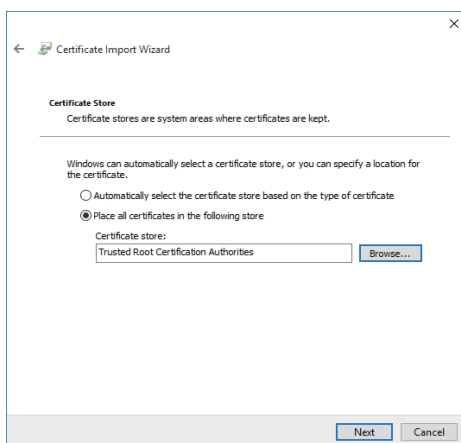

9. Click [Finish].

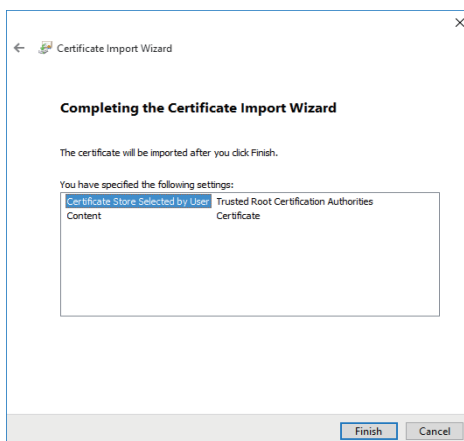

10. Click [Yes].

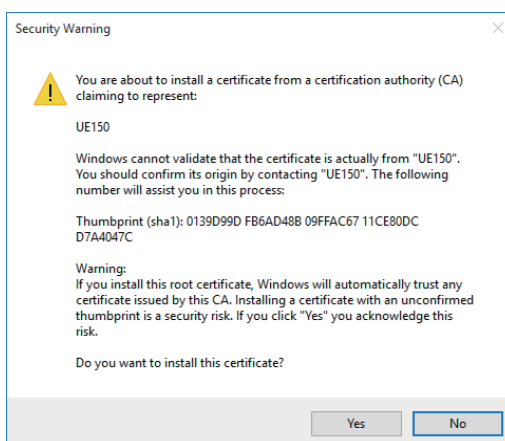

When importing is finished, the "The import was successful." screen is displayed.

11. Click [OK].

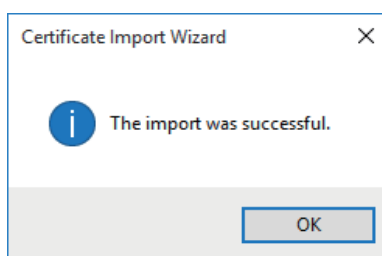

Closing the web browser after importing the certificate and reconnecting to it will stop the "Certificate error" screen being displayed.

COMMON

Click [COMMON] in the Network settings screen [NETWORK].

Make shared network settings.

Confirm the settings with the [SET] button.

___ indicates factory default settings.

Item	Setting value	Setting details
EASYIP SETUP ACCOMMODATE PERIOD	<u>20MIN.</u> UNLIMITED	<p>Sets the time allowed for network setting operations from EasyIP Setup Tool Plus.</p> <p>20MIN. Allows camera setting operations on the EasyIP Setup Tool Plus for just 20 minutes after start up of this unit.</p> <p>UNLIMITED Allows camera setting operations on the EasyIP Setup Tool Plus at any time.</p> <ul style="list-style-type: none"> • Camera display on the EasyIP Setup Tool Plus is enabled all the time, and the camera screen can be opened. • Consult the network administrator regarding the address settings for the different servers.
EASYIP SETUP PLUS PLAIN TEXT USAGE	ENABLE <u>DISABLE</u>	<p>Sets whether to enable or disable encryption of communications when communicating with EasyIP Setup Tool Plus.</p> <p>ENABLE Communications are sent and received as plain messages.</p> <p>DISABLE Communications are sent and received as encrypted messages.</p>

ROP account settings screen [ROP ACCOUNT SETTING]

Make the settings for user accounts required to connect to ROPs (AK-HRP1010 and AK-HRP1015) and an MSU (AK-MSU1000) from this unit in the ROP account settings screen [ROP ACCOUNT SETTING]. The accounts can also be deleted here. You can register a maximum of 12 users.

The ROP account settings screen [ROP ACCOUNT SETTING] consists of [USER LIST] and [ADD USER].

USER LIST

Click [USER LIST] in the ROP account settings screen [ROP ACCOUNT SETTING].

Information about accounts already registered is displayed.

To delete a registered user account, click the [DELETE] button to the right of the relevant account.

ADD USER

Registers a user account.

Item	Setting details
USER NAME	Enter the user name. <ul style="list-style-type: none"> • Maximum number of characters 1 to 8 half-size characters • Characters that can be entered <ul style="list-style-type: none"> • Half-size numeric characters: 0123456789 • Half-size alphabetical characters (upper and lower cases): ABCDEFGHIJKLMNOPQRSTUVWXYZ abcdefghijklmnopqrstuvwxyz • Symbols: - _ #
PASSWORD RETYPE PASSWORD	Enter the password. <ul style="list-style-type: none"> • Maximum number of characters 1 to 31 half-size characters

User management screen [USER MNG.]

In the User management screen [USER MNG.], register authentication for users that can access this unit from personal computers and mobile terminals. Up to 3 users can be registered.

The User management screen [USER MNG.] consists of [USER LIST] and [ADD USER].

NOTE

- If user authentication fails more than 8 times within a 30-second period from the same IP address (personal computer), access to the unit will be disabled for a certain period.

USER LIST

Click [USER LIST] in the User management screen [USER MNG.].

Information about accounts already registered is displayed.

To delete a registered user account, click the [DELETE] button to the right of the relevant account.

NOTE

- If there is 1 registered account, you cannot delete that account.

ADD USER

Registers a user account.

Item	Setting details
USER NAME	Enter the user name. <ul style="list-style-type: none"> • Maximum number of characters 1 to 32 half-size characters • Characters that can be entered <ul style="list-style-type: none"> • Half-size numeric characters: 0123456789 • Half-size alphabetical characters (upper and lower cases): ABCDEFGHIJKLMNOPQRSTUVWXYZ abcdefghijklmnopqrstuvwxyz • Symbols: !#\$%&'()*+,-./?@[]^_`~
PASSWORD RETYPE PASSWORD	Enter the password. <ul style="list-style-type: none"> • Maximum number of characters 4 to 32 half-size characters

Troubleshooting

Operation

Symptom	Cause and Measure
Cannot turn the power on.	<ul style="list-style-type: none"> Is the power cable connected to the outlet properly?
Cannot perform operation from an ROP connected with an IP connection.	<ul style="list-style-type: none"> Is the power on? <ul style="list-style-type: none"> If the LCD panel of this unit is off, the power of this unit is not turned on. Is a valid IP address set on the unit? Is the unit you want to operate selected correctly? Is the ROP connected correctly? <ul style="list-style-type: none"> Also refer to the operating instructions for the ROP. The version of the ROP may need to be upgraded to enable support for the unit. <ul style="list-style-type: none"> Consult your dealer.
Cannot access from a web browser	<ul style="list-style-type: none"> Did you use a LAN cable of category 5e or higher for connecting to the [LAN] connector? Is the [LINK] LED of the [LAN] connector lit? <ul style="list-style-type: none"> If it is not lit, the unit is not connected to the LAN properly or the network of the connection destination is not operating properly. Check the LAN cable for a bad electrical contact and make sure the connections are correct. Is the power on? <ul style="list-style-type: none"> If the LCD panel of this unit is off, the power of this unit is not turned on. Is a valid IP address set on the unit? Is the wrong IP address being accessed? (Windows) <ul style="list-style-type: none"> Using the Windows command prompt, execute > ping [IP address which has been set in this unit] A reply returned from the unit signifies that there are no problems in operation. If a reply is not received, reboot the unit, and within 20 minutes change the IP address using the EasyIP Setup Tool Plus. Is the wrong IP address being accessed? (Mac) <ul style="list-style-type: none"> Using the OS X terminal, execute > ping -c 10 [IP address which has been set in this unit] A reply returned from the unit signifies that there are no problems in operation. Has 554 been set as the HTTP port number? <ul style="list-style-type: none"> For the HTTP port number, use a port number other than the following port numbers that are used by the unit. 20, 21, 23, 25, 42, 53, 67, 68, 69, 110, 123, 161, 162, 554, 995, 10669, 10670 Is the set IP address the same as that of another device? <ul style="list-style-type: none"> Check out the IP addresses of the unit, access devices (personal computer, controller, etc.) and any other cameras. Does the subnet mask setting match the network subnet of the connection destination? <ul style="list-style-type: none"> Check out the subnet mask settings of the unit and access devices, and then consult with the network administrator. Is the Web browser set to "Use a proxy server"? (When the unit and the personal computer are connected to the same subnet) <ul style="list-style-type: none"> If a proxy server has been set using the [proxy setting] of the web browser, it is recommended that a "Don't use proxy" address be selected as the unit's IP address setting. Has the wrong default gateway been set for the unit? (When the unit and personal computer are connected to different subnets) <ul style="list-style-type: none"> Check out the default gateway that has been set for the unit, and then consult with the network administrator.

Symptom	Cause and Measure
<p>The setting values of the [Setup] screen are not updated properly or are not displayed.</p>	<ul style="list-style-type: none"> ● Press the [F5] key on the personal computer keyboard to request the setting values to be obtained. (Windows) ● Press the [Command] + [R] key on the personal computer keyboard to request the setting values to be obtained. (Mac) ● Delete the temporary Internet files as described below. (Mac) <ol style="list-style-type: none"> 1. Select [Safari] - [Empty Cache] in Safari. 2. Click the [Delete] button under [Browsing history]. ● Delete the temporary Internet files as described below. (Windows) <ol style="list-style-type: none"> 1. Select [...] - [History] in Microsoft Edge. 2. Select [...] - [Clear browsing data]. 3. Select the [Browsing history], [Download history], [Cookies and other site data], and [Cached images and files] checkboxes and click [Clear now]. ● A port of the unit may be being filtered by, for example, the firewall function of the antivirus software. <ul style="list-style-type: none"> ● Change the HTTP port number of the unit to a port number that is not filtered.
<p>It is not possible to download the setting files</p>	<ul style="list-style-type: none"> ● Are pop-up windows blocked? (Windows) <ul style="list-style-type: none"> ● Perform the following. <ol style="list-style-type: none"> 1. In Microsoft Edge, select [...]-[Settings]. 2. Select [Cookies and site permissions]. 3. Select [Pop-ups and redirects]. 4. Turn off [Block(recommended)].
<p>The authentication screen appears repeatedly</p>	<ul style="list-style-type: none"> ● Has the user name or password been changed? <ul style="list-style-type: none"> ● If you change the user name and password of the user currently logged in from a separate web browser while the unit is being accessed, the authentication screen appears each time the screen display is changed. Close the web browser, and initiate access to the unit again.
<p>Screens displays take a while to appear</p>	<ul style="list-style-type: none"> ● Is the unit on the same local network being accessed via proxy? <ul style="list-style-type: none"> ● Configure the web browser settings so that access is not performed via proxy. ● Are multiple users accessing the unit's IP images at the same time? <ul style="list-style-type: none"> ● When multiple users access the unit's IP images at the same time, images may take some time to appear, and the frame rate of the IP images may decrease.

Web Screen

Depending on the OS installed on the personal computer, the following may occur. If a problem occurs, take the corresponding measure. Performing the following solutions will not affect the operation of other applications.

The “information bar” described in the following explanations refers to the message bars that appear in Microsoft Edge. (Windows)
The information bar appears at the bottom of Microsoft Edge.

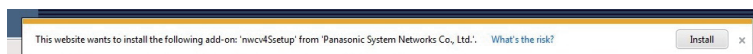

Symptom	Cause and Measure
<p>The following message appears in the information bar. [This website wants to run the following add-on: 'WebVideo Module' from 'Panasonic System Networks Co.,Ltd.'.]</p>	<ul style="list-style-type: none"> • Select [Allow].
<p>The following message appears in the information bar. [This website wants to install the following add-on: 'nwc4SSetup.exe' from 'Panasonic System Networks Co.,Ltd.'.]</p>	<ul style="list-style-type: none"> • Select [Install]. When the security warning window appears, click the [Install] button.
<p>The IP images do not match the display frames</p>	<ul style="list-style-type: none"> • Images may not appear correctly if their DPI settings are 120 DPI or higher. <ul style="list-style-type: none"> • Right-click on the desktop of the personal computer, click [Display settings] - [Change the size of text, apps, and other items], and select [100% (Recommended)]. • Images may not appear correctly if the zoom level is set to anything other than 100% in Microsoft Edge. <ul style="list-style-type: none"> • Go to [...] - [Zoom] in Microsoft Edge and click [-] and [+] to set to [100%].

Reference

Connector pin assignment table

Front panel

[INTERCOM] connector (page 16: 2)

HA16PRH-5S (Hirose Electric Co., Ltd.)

Pin No.	Function	Remarks
1	SHIELD	Carbon MIC: -1 dB Dynamic MIC: -5 dB • Select [DYN] , [ECM], or [CBN] in [MIC TYPE] that can be accessed by selecting [CCU INTERCOM TALK] in the [AUDIO] menu.
2	TALK	
3	SHIELD	
4	RECEIVE	
5	NC	

Rear panel

[TALLY OUT] connector (page 19: 8)

HR10A-7R-4SC (Hirose Electric Co., Ltd.)

Pin No.	Function	Specifications	Remarks
1	GND	Ground	
2	TALLY R OUT	Open collector output	➔ "Example of tally and alarm output connections" (see page 131)
3	TALLY G OUT	Open collector output	
4	ALARM	Open collector output	

Example of tally and alarm output connections

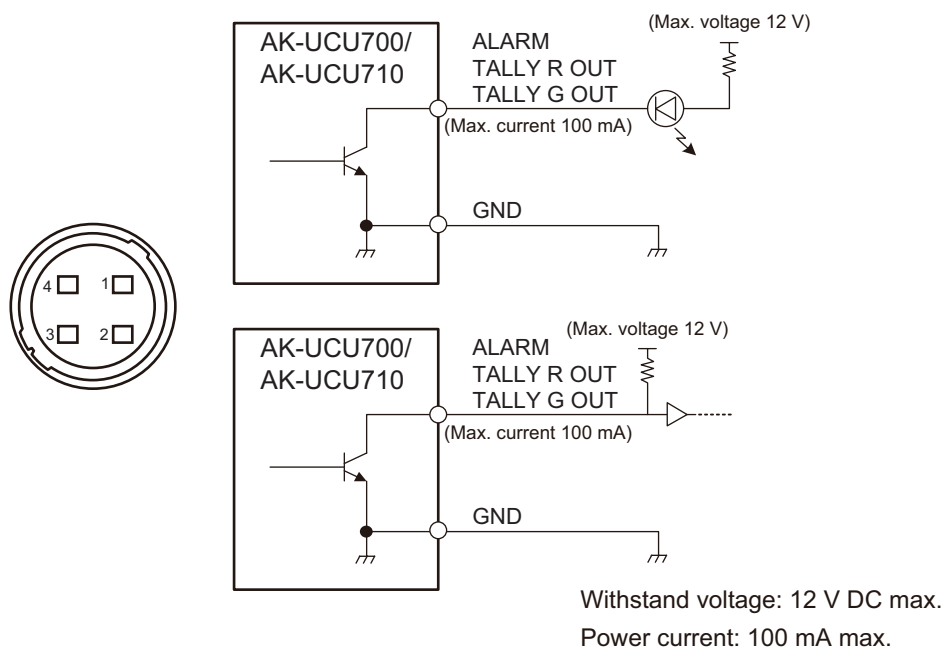

[COMMUNICATION] connector (page 19: 3)

JBY-25S-1A3F(LF)(SN) (J.S.T. Mfg. Co., Ltd.)

Pin No.	Function	Flow of signal	Remarks
1	INCOM ENG OUT (H)	CCU→SYSTEM	0 dBm, 600 Ω (4 W) / 1 V [p-p], 200 Ω (RTS) 4 W/RTS/CLRCOM ● Selected using a menu
2	INCOM ENG OUT (C)	CCU→SYSTEM	
3	INCOM ENG (GND)		
4	INCOM ENG IN (H)	SYSTEM→CCU	
5	INCOM ENG IN (C)	SYSTEM→CCU	
6	PGM IN (H)	SYSTEM→CCU	0 dBm/-20 dBm, 600 Ω ● Selected using a menu
7	PGM IN (C)	SYSTEM→CCU	
8	PGM IN (GND)		
9	GND		
10	NC		
11	R TALLY IN (H)	SYSTEM→CCU	ON: Short/TTL(H)/24 V ➔ "Example of tally input connections" (see page 133) OFF: Open/TTL(L)/0 V
12	R TALLY IN (C)	SYSTEM→CCU	
13	GND		
14	INCOM PROD OUT (H)	CCU→SYSTEM	0 dBm, 600 Ω (4 W) / 1 V [p-p], 200 Ω (RTS) 4 W/RTS/CLRCOM ● Selected using a menu
15	INCOM PROD OUT (C)	CCU→SYSTEM	
16	INCOM PROD (GND)		
17	INCOM PROD IN (H)	SYSTEM→CCU	
18	INCOM PROD IN (C)	SYSTEM→CCU	
19	PGM2 IN (H)	SYSTEM→CCU	0 dBm/-20 dBm, 600 Ω ● Selected using a menu
20	PGM2 IN (C)	SYSTEM→CCU	
21	PGM2 IN (GND)		
22	YL TALLY IN (H)	SYSTEM→CCU	ON: Short/TTL(H)/24 V ➔ "Example of tally input connections" (see page 133) OFF: Open/TTL(L)/0 V
23	YL TALLY IN (C)	SYSTEM→CCU	
24	G TALLY IN (H)	SYSTEM→CCU	
25	G TALLY IN (C)	SYSTEM→CCU	

Example of tally input connections

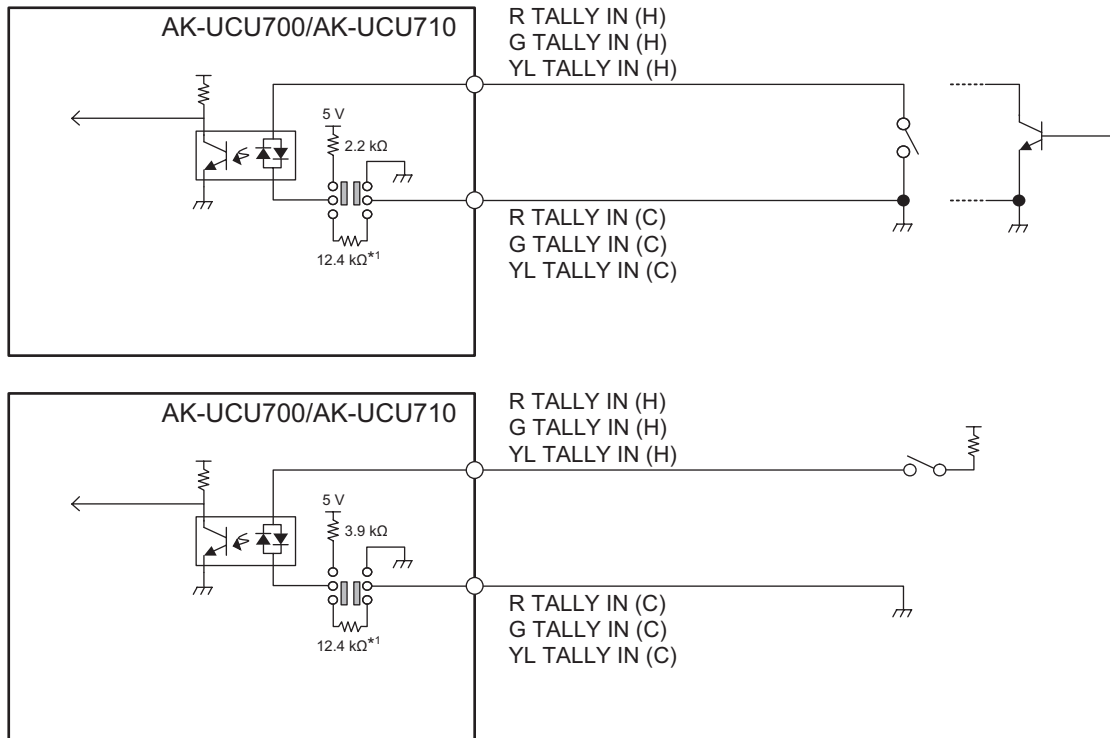

*1: Equivalent circuit

[ROP] connector (page 19: 2)

HR10G-10R-10SC (71) (Hirose Electric Co., Ltd.)

Pin No.	Function	Flow of signal
1	ROP CONT (H)	CCU→ROP
2	ROP CONT (C)	CCU→ROP
3	ROP DATA (H)	ROP→CCU
4	ROP DATA (C)	ROP→CCU
5	NC	
6	NC	
7	NC	
8	NC	
9	+16 V OUT	CCU→ROP
10	GND	

- Connector of cable

HR10A-10P-10P (73)

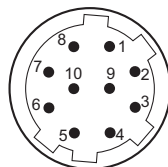

[MSU] connector (page 19: 1)

HR10G-10R-10SC (71) (Hirose Electric Co., Ltd.)

Pin No.	Function	Flow of signal
1	MSU CONT (H)	CCU→MSU
2	MSU CONT (C)	CCU→MSU
3	MSU DATA (H)	MSU→CCU
4	MSU DATA (C)	MSU→CCU
5	TALLY R	CCU→MSU
6	TALLY G	CCU→MSU
7	HEAD POWER	CCU→MSU
8	ALARM 1	CCU→MSU
9	ALARM 0	CCU→MSU
10	GND	

- Connector of cable
HR10A-10P-10P (73)

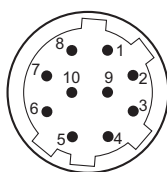
**[MIC1] and [MIC2] connectors (page 19: 9)**

HA16RV-3PG(76) (Hirose Electric Co., Ltd.)

Pin No.	Function	Flow of signal	Remarks
1	SHIELD		0 dBm, 600 Ω
2	HOT	CCU→SYSTEM	
3	COLD	CCU→SYSTEM	

- When connecting to an unbalanced input terminal of an external device, connect to it as shown in the diagram below.

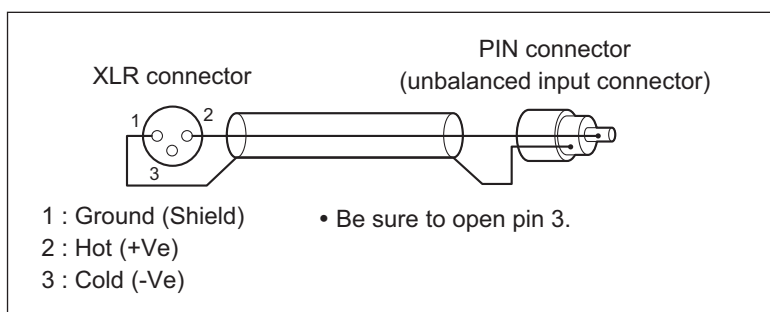

- Some commercially available conversion connectors and conversion cables have pin 3 shorted to pin 1. Using such a conversion connector or conversion cable will cause a failure.

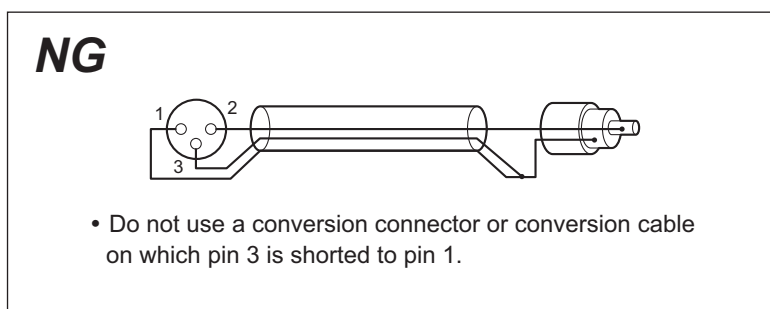

[CAMERA] connector (page 19: 10)

AK-UCU700P/E, AK-UCU710P/E: OPS2404-PR (Tajimi Electronics Co., Ltd.)

AK-UCU700PS/ES, AK-UCU710PS/ES: FXW.3K.93C.TLM (LEMO)

Pin No.	Function	Flow of signal
1	Optical fiber	CAM → CCU
2	Optical fiber	CCU → CAM
3	Control line	CCU←→CAM
4	Control line	CCU←→CAM
5	AC 240 V	CCU → CAM
6	AC 240 V	CCU → CAM

Front panel G/L indicator specifications

✓: Green light ×: Orange light -: Off

FORMAT	REF-IN					
	1080/59.94i	1080/23.98PsF	525/59.94i	1080/50i	625/50i	No input
2160/59.94p	✓	×	✓	×	×	-
2160/29.97p	✓	×	✓	×	×	-
2160/23.98p	×	✓	x ^{*1}	×	×	-
1080/59.94p	✓	×	✓	×	×	-
1080/29.97p	✓	×	✓	×	×	-
1080/23.98p	×	✓	x ^{*1}	×	×	-
2160/59.94p-120fps	✓	×	✓	×	×	-
1080/59.94p-240fps	✓	×	✓	×	×	-
1080/59.94p-180fps	✓	×	✓	×	×	-
1080/59.94p-120fps	✓	×	✓	×	×	-
2160/50p	×	×	×	✓	✓	-
2160/25p	×	×	×	✓	✓	-
1080/50p	×	×	×	✓	✓	-
1080/25p	×	×	×	✓	✓	-
2160/50p-100fps	×	×	×	✓	✓	-
1080/50p-200fps	×	×	×	✓	✓	-
1080/50p-150fps	×	×	×	✓	✓	-
1080/50p-100fps	×	×	×	✓	✓	-

*1: Lights when there is a 10-field ID

Appearance

Unit: mm (inch)

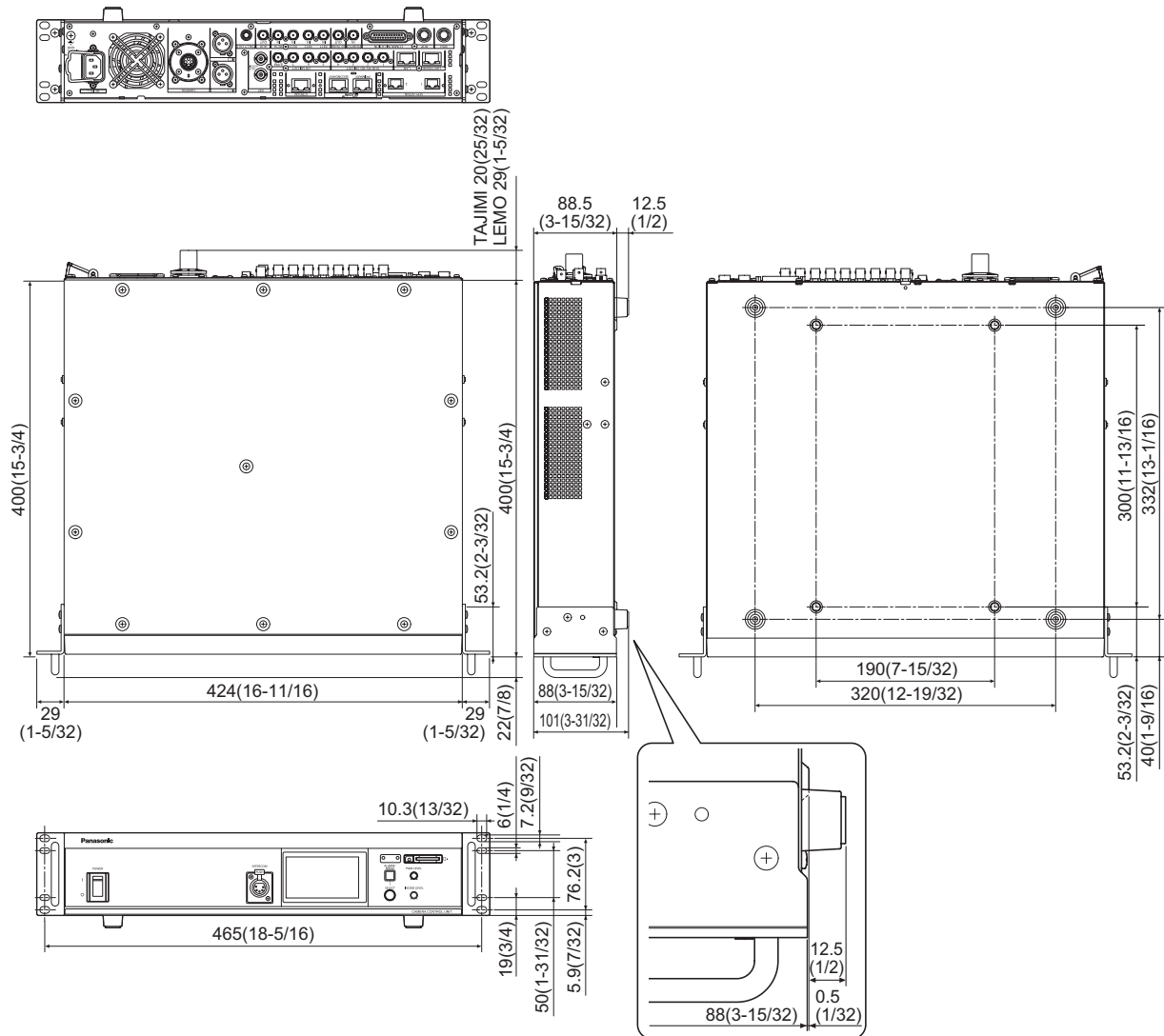

Specifications

Power supply	100 V - 240 V AC (⎓), 50 Hz/60 Hz
Power consumption	550 W (Without camera connected: 130 W)
Capacity for supplying power to a camera	240 V AC (⎓), 1.46 A, 50 Hz/60 Hz

 indicates safety information.

Operating temperature	0 °C to 40 °C (32 °F to 104 °F)
Humidity	10% to 90% (no condensation)
Dimensions (Width×Height×Depth)	424 mm × 88.5 mm × 400 mm (16-11/16 inches × 3-15/32 inches × 15-3/4 inches) (excluding protrusions)
Weight	AK-UCU700 : Approx. 9.1 kg (20.02 lb) AK-UCU710 : Approx. 9.3 kg (20.46 lb)
Video output	3G/HD-SDI 5 lines
	12G/6G/3G/HD-SDI 2 lines
	HD-SDI 1 line
HD TRUNK output	3G/HD-SDI 1 line
AUX output	3G/HD-SDI 1 line
Return input	3G/HD-SDI 4 lines
HD TRUNK (prompter) input	3G/HD-SDI 1 line
Reference input	BB (black burst) / tri-level 1 line (automatic termination, connect to upper connector; BB signal and tri-level signal automatically recognized, with loop-through output)
Microphone output	0 dBm/600 Ω 2 lines (XLR, 3-pin, male)
Communication	Intercom input/output (ENG / PROD, 0 dBm, 600 Ω (4 W) / 1 V [p-p], 200 Ω (RTS), 4 W / RTS / CLRCOM) 2 lines
	PGM input (0 dBm/600 Ω) 2 lines
	Tally input (red, green, yellow) 1 input each
TALLY output	Tally output (red, green) Alarm output Output from each of the open collectors
ROP	RS-422 1 line, 16 V DC output
MSU	RS-422 1 line, GPI for control
LAN TRUNK	1 line
LAN	1 line
LCD monitor	3.5-inch LCD monitor, touch panel supported
MOIP (AK-UCU710 only)	SFP+/SFP28 slot 2 lines
DANTE (AK-UCU710 only)	RJ45 2 lines

The symbols on this product (including the accessories) represent the following:

~	AC
	Power on
○	Power off

 **NOTE**

- For details on the maximum lengths of connection cables, consult your dealer.

Inrush current, measured according to European standard EN55103-1, on initial switch-on: 3 A, after a supply interruption of 5 s: 80 A

Index

- A**
 - Accessories 12
 - AC power socket 19
 - ALARM lamp 17
 - AUDIO 55
 - Auto displays 33
 - AUX OUT connector 19
- B**
 - BAR ID 53
- C**
 - CAMERA connector 19, 135
 - CCU INTERCOM RECEIVE 56
 - CCU INTERCOM TALK 56
 - CCU VERSION 85
 - COMMUNICATION 57
 - COMMUNICATION connector 19, 132
 - Cooling fan 19
- D**
 - Dante connector 20
 - DNS SETTING 80
- E**
 - EasyIP Setup Tool Plus 92
- H**
 - HD PHASE 52
 - HD SDI OUT connectors 18
 - HD TRUNK OUT connector 19
 - HTTPS 114, 121
 - CA CERTIFICATE
 - CA CERTIFICATE INSTALL 120
 - GENERATE CERTIFICATE SIGNING REQUEST 119
 - CONNECTION 121
 - CRT KEY GENERATE 116
 - Security certificate 122
 - SELF-SIGNED CERTIFICATE
 - GENERATE 117
- I**
 - INCOM LEVEL adjustment dial 17
 - INITIALIZE 89
 - INTERCOM1 58
 - INTERCOM2 59
 - INTERCOM connector 16, 131
 - IRIS 24
- L**
 - LAN 62
 - LAN connector 18
 - LAN TRUNK connector 18
 - LCD panel 16, 34
- M**
 - MAINTENANCE 81
 - Memory card access lamp 17
 - Memory card slot 17
 - Menu
 - Displaying 40
 - Operations 39
 - MENU button 17
 - MIC connector 19, 134
 - MIC OUT 55
 - MoIP FORMAT 60
 - MSU connector 19, 134
- N**
 - ND/CC NAME 84
 - NDI/SRT SETTING 79
 - NETWORK 61
 - NMOS SETTING 78
- O**
 - OPERATION 46
 - Operation displays 32
 - OPTION VERSION 85
 - OUTPUT FORMAT 49
- P**
 - PGM 60
 - PGM LEVEL adjustment dial 17
 - Picture monitor 21
 - PM OPERATION STATUS 87
 - PM VIEW SETTING 86
 - POWER switch 16
 - PROMPTER IN connector 19
 - PTP SETTING 64
- R**
 - REF connectors 18
 - RET1 IN to RET4 IN connectors 19
 - ROP connector 19, 133

S

SD CARD	90
SELECT dial	17
SETTING	51
SETUP	82
SFP+/SFP28 slot	20
SFP1(PRIMARY)	66
SFP1(PRIMARY)RX	69
SFP1(PRIMARY)TX	67
SFP2(SECONDARY)	72
SFP2(SECONDARY)RX	75
SFP2(SECONDARY)TX	73
SIGNAL GND terminal	19
SOURCE SETTING	54
ST2110 SETTING	65
START UP	82
Status	26, 27, 28, 29, 30, 31
Status displays	25
Status display screen	25
STREAM connector	20
SYSTEM	88
SYSTEM MODE	47

T

TALLY IN SETTING	63
TALLY OUT connector	19, 131
Text input	
CCU menu	44
LCD panel	38

U

UHD/HS/HD SDI OUT connectors	18
------------------------------------	----

W

WARNING	23
Web Screen	92

Panasonic Connect Co., Ltd.

Web Site: <https://pro-av.panasonic.net/en/>

© Panasonic Connect Co., Ltd. 2024