

# HP Z640 Workstation

Flexible, powerful, ready to work



Redefine versatility and flexibility. Expand your capabilities with HP's Z640 Workstation offering powerful performance, whisper-quiet computing, and tool-less access in a compact design.

## Table of contents

|  |    |
|--|----|
| Chassis and system highlights .....            | 2  |
| System architecture .....                      | 3  |
| I/O slot optimizations.....                    | 8  |
| Storage configurations and RAID .....          | 11 |
| Memory configurations and optimization.....    | 18 |
| New UEFI BIOS and features/legacy support..... | 23 |

# Chassis and system highlights

More power! More performance! HP is excited to introduce the Z640 Workstation. This surprisingly small workstation has been optimized to provide maximum performance in minimal space. The HP Z640 continues to offer a convenient tool-free design, amazingly quiet acoustics, and impressive expandability for its product size.

## Mobility and flexibility

Our customers continue to express the need for easy system mobility. Like its predecessor, the HP Z640 has full-grip integrated carrying handles and one can easily slide the system around on a variety of surfaces. In addition, a convenient landing pad has been integrated into the top surface of the workstation for storing accessories such as a mobile phone being charged by the front USB 3.0 charging port.

The flexible HP Z640 design allows for the system to be used in the tower orientation or rack-mounted with enterprise-class rails. To offer additional flexibility in deployment, the HP Z640 is modular by design allowing it to be configured as a single or dual processor system. The optional 2nd processor module provides the second CPU and four additional memory slots—providing a total of eight DIMM slots for this very compact dual processor workstation! Adding or upgrading memory on the 2nd processor module is extremely easy—no tools required and it takes only seconds to remove and install, featuring intuitive touchpoints and handles, user-friendly positive latching, self-aligning guides, and blind-mate (no cable) interconnections.

With two internal storage bays, two standard 5.25" external device bays, a dedicated 9.5mm slim ODD bay, three PCIe Gen3 slots (1x8 and 2x16), two PCIe Gen 2 slots (1x4 and 1x1), along with a single PCI slot the HP Z640 delivers flexibility for storage and accessory options. The internal storage bays feature tool-free drive trays which are compatible with industry standard 3.5" storage devices or 2.5" devices with the appropriate carrier. The HP Z640 also provides tool-free accessibility to the external device bays—expanding storage capabilities or allowing additional I/O options as needed with just a few simple steps.

## Interior design

The streamlined interior is well organized and all user serviceable components are identified with consistent green touchpoints. Cables are hidden or efficiently routed, providing better component access and airflow management.



## Tool-free design

HP has always been a leader in tool-free product design and with the HP Z640, the serviceability could not be any easier! The following components can be easily accessed or upgraded without tools: side access panel, hard drives, optical drives, memory, expansion cards, power supply, system board, and the 2nd processor module. The hard drives are also direct-connect and can be swapped in and out without dealing with cables. Users will find the translucent hard drive carriers very helpful when determining which bays are populated with a drive.



## Security

Due to the tool-free ease of use, HP understands system and component security may be a concern; therefore, several security features have been incorporated. The side access panel key lock and a security slot are included standard. A system intrusion sensor and a remote/centrally controlled solenoid lock are optional accessories.

## Quiet and reliable

Acoustic noise is very important to HP and our customers because a noisy environment can increase user fatigue and reduces productivity. HP continues its leadership in this area with the design of the Z640. With its extra power and capability, one might expect the HP Z640 to be louder than the already very quiet HP Z620. However, with some innovative engineering using very efficient heatsink design, strategically placed fans, and active fan control, the HP Z640 is even quieter. As with all our workstations, the hard drives are mechanically isolated to reduce vibration and noise. The system is arranged so that sensitive components receive fresh cool air. With internal fans distributed throughout the system, airflow is targeted at the high power-density components. HP's advanced algorithms control fan speeds in real time based on system configuration, environment, and key component temperatures to provide users with an exceptionally quiet system and uncompromising reliability and performance.

While low acoustics and thermal reliability are priorities, it is also important that the system can withstand difficult physical conditions. The HP Z640 is built to withstand high shock and vibration environments. Rigorous climatic and dynamic testing helps to ensure that HP Workstations are highly reliable in demanding conditions.

## Designed with the environment in mind

HP is committed to environmental sustainability and energy efficiency. To reduce energy consumption, HP Workstations offer ENERGY STAR® qualified configurations and the HP Z640 features a 90% efficient power supply. The HP Workstation design team has taken a proactive approach (beyond industry regulations) to recyclability and selecting materials that reduce the risk to the environment. HP Z640 configurations are available with low-halogen materials.<sup>1</sup>

# System architecture

The HP Z640 is the successor to the HP Z620 personal workstation. Its architecture introduces several new functionalities and technologies. These include DDR4 memory architecture, Intel®-integrated USB 3.0, I/O slot improvements and better performance.

## New technologies

### New Intel® Processor micro-architecture

The HP Z640 Workstation uses the Intel® C612 chipset to support the latest up to eighteen-core Intel® Xeon® E5-1600 and E5-2600 processor series (Haswell, 22 nm), including processors of up to 145 W. Intel® Haswell processors feature a new micro-architecture and a new instruction set including AVX2 (Advanced Vector Extensions 2.0) and FMA (Floating-point fused Multiply Add instructions) that help deliver faster compute performance, with low energy consumption. The integrated 4-channel DDR4 memory controller and dual QPI processor interconnect at up to 9.6 GT/s and increase peak data transfer and bandwidth over the HP Z620.

### Intel® Advanced Vector Extensions 2.0 (Intel® AVX2)

The new Intel® Advanced Vector Extensions 2.0 (Intel® AVX2) extends the Intel® Advanced Vector Extensions (Intel® AVX) with 256-bit integer instructions, floating-point fused multiply add (FMA) instructions, and gather operations. The 256-bit integer vectors benefit math, codec, image, and digital signal processing software. FMA can improve performance in face detection, professional imaging, and high-performance computing. Gather operations increase vectorization opportunities for many applications. In addition to the vector extensions, this generation of Intel® processors adds new bit manipulation instructions useful in compression, encryption, and general purpose software.

### Intel® Data Protection Technology with AES-NI (Intel® AES-NI)

The Intel® Advanced Encryption Standard New Instructions (Intel® AES-NI) are a set of Single Instruction Multiple Data (SIMD) instructions that enable fast and secure data encryption and decryption based on the Advanced Encryption Standard (AES). Intel® AES-NI is valuable for a wide range of cryptographic applications, such as applications that perform bulk encryption/decryption, authentication, random number generation, and authenticated encryption. AES is broadly accepted as the standard for both government and industry applications, and is widely deployed in various protocols.

### Next generation Intel® Active Management Technology

New features for Intel® AMT 9.1 include:

- The Intel® AMT network can now be enabled and disabled.
- Any configuration software can now synchronize the Intel® AMT network time to coordinate with UTC.
- The ability to configure a headless platform remotely without the need for local user-consent has been added.
- Graceful shutdown support
  - Earlier versions only supported hard power operations, which can cause unpredictable system behavior. AMT 9.1 adds support for graceful power operations that include Shutdown/Reset/Sleep-deep/Hibernate to improve system stability.

### Memory technology

The HP Z640 Workstation introduces support for DDR4 2133 MHz Registered DIMMs. The speed that the memory runs is determined by the processors and is limited to 2133 MHz for the Haswell processor generation. DDR4 LR DIMMs (load-reduced DIMMS) are also supported and enable a total system memory size up to 256 GB.<sup>2\*</sup> Channel interleaving is supported and dynamic power saving is enabled. NUMA and Non-NUMA modes are supported when the second processor is present.

\* May not be available at launch

## Intel® USB 3.0

The Intel® C612 PCH has an integrated USB 3.0 controller which provides the four rear, one internal, and four front USB 3.0 ports on the HP Z640 Workstation. The Intel® C612 USB 3.0 controller provides cost-effective support for greater I/O bandwidth than was provided by the HP Z620 solution. More information on the USB 3.0 Technology and Performance measurements can be found in the “Resources, contacts, or additional links” section at the end of this document.

## USB charging ability

The HP Z640 Workstation equips the top-most of the front USB 3.0 ports with power charging ability. The port is able to provide fast charge (up to 1.5A) to a portable device in the following states: System On, System Sleep, System Hibernate and System Off. It does not support charging in the ErP (Max S5 Power Savings) state. The port supports USB Battery Charging Specification 1.2. The port is marked by the battery charging icon shown here. More information on USB Charging technology can be found in the “Resources, contacts, or additional links” section at the end of this document.

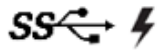

## Thunderbolt™ 2<sup>3</sup> technology

The HP Z640 Workstation provides Thunderbolt™ 2 technology via the optional HP Thunderbolt™ 2 PCIe 1-port I/O card. The HP Thunderbolt™ 2 PCIe 1-port I/O Card uses the Intel DSL5520 Thunderbolt™ 2 controller and provides a single Thunderbolt™ 2 port.

Each Thunderbolt™ 2 port provides:

- 20 Gb/s data in each direction
- 12 W of power (2 W for cable, 10 W for bus-powered device)
- DisplayPort 1.2 capability with Multi Stream Transport (MST) support that enables the transport of multiple A/V streams over a single connector
  - Maximum 4096 x 2160 resolution at 60 Hz (8-bit display) or at 30 Hz (10-bit display) to a single display
  - Maximum 3840 x 2160 resolution at 60 Hz (8-bit display) or at 30 Hz (10-bit display) across 4 displays
    - Each of the 4 displays can support a 1920 x 1080 resolution
- 4K video file capture and display simultaneously
- Full backward compatibility with Thunderbolt™ 2 devices.

For more information on Thunderbolt™ 2 technology, benefits and installation, please refer to the “Resources, contacts, or additional links” section at the end of this document.

## I/O and storage

### Internal I/O

- The HP Z640 provides a total of five high-performance graphics and I/O slots.
- The HP Z640 provides two PCIe3 x16, one PCIe3 x8, and one PCIe2 x4.
- When in a single processor configuration an additional PCIe2 x1 dedicated electrical slot is available.
- All slots match the mechanical lengths to their electrical lengths and are open ended.
- The HP Z640 also maintains a single PCI slot that is derived from a PCIe to PCI Bridge that brings the total number of I/O slots to six.
- The HP Z640 provides an internal 1-port USB 3.0 connector and an internal 2-port USB 2.0 header.

## Storage

The C612 chipset supports two SATA AHCI controllers, sSATA and SATA. The sSATA controller supports four 6 Gb/s ports and RAID modes 0, 1, 10 and 5. The SATA controller supports two 6 Gb/s ports and RAID modes 0 and 1. Ports from both controllers can be routed to the rear panel with an eSATA bulkhead option. Note that it is not possible to RAID across the two SATA controllers.

The optional HP Z Turbo Drive featuring a PCIe connected SSD is supported on this platform and provides performance levels greater than 1 GB/s. Up to two Z Turbo drives can be configured in the factory. Data RAID is supported through Microsoft Windows Disk Manager.

## External I/O

On the front I/O area, the HP Z640 provides four USB 3.0 ports (the top-most supports battery charging), combo headset and separate microphone connections.

In the rear I/O area, the HP Z640 provides four USB 3.0 ports, two USB 2.0 ports, one gigabit ethernet LAN port, audio Line-In, audio Line-Out, and PS/2. Additional rear I/O ports can be added via PCIe add-in cards.

## Graphics

The HP Z640 Workstation will support up to a single 300 W graphics card. Separately, in a single processor configuration the HP Z640 will support up to two cards rated at 225 W each. In a dual processor configuration two cards rated up to 150 W each are supported.

## Other features

- 925 W power supply, 90% efficient
- Rear panel power on/off switch and LED for easier rack maintenance
- ENERGY STAR® qualified configurations, China's Energy Conservation Program (CECP) configurations, European Union's ErP LOT6 2013 power limit of 0.5 W in off mode.
- Intel® vPro™<sup>4</sup> manageability with support both for DASH and Intel® AMT (Advanced Manageability Technology) on all the Xeon® processors. IT managers now have increased flexibility in optimizing their Enterprise manageability strategy across HP's Commercial Notebooks, Desktops, and Workstations.

## HP Z640 vs HP Z620 feature comparison

**Table 1. HP Z640 vs HP Z620 feature comparison**

|                            | HP Z640  | HP Z620  |
|----------------------------|--|--|
| <b>Operating System</b>    | Windows 8.1 Professional 64-bit*<br>Windows 7 Professional 64-bit* | Windows 8 Professional 64-bit*<br>Windows 7 Professional 64-bit*<br>Windows 7 Professional 32-bit* |
| <b>Processors</b>          | Intel® Xeon® E5-2600v3<br>Intel® Xeon® E5-1600v3                   | Intel® Xeon® E5-2600v2   |
| <b>New instruction set</b> | AVX2<br>AES-NI   | AVX<br>AES   |
| <b>Memory technology</b>   | DDR4: Registered and LR-DIMMs<br>Up to 2133 MHz                    | DDR3: Unbuffered ECC and Registered DIMMs<br>Up to 1866 MHz  |
| <b>USB enhancement</b>     | USB charging port on top-most front port                           | N/A  |
| <b>USB 3.0 ports</b>       | 4 Rear, 4 Front, 1 Internal  | 2 Rear, 2 Front, 0 Internal  |
| <b>Manageability</b>       | Intel® ME9.1/AMT9.1, Intel® vPro                                   | Intel® ME8.1/AMT8.1, Intel® vPro   |

## HP Z640 supported CPU line-up

Table 2.

|                     | Model      | Clock Speed (GHz) | Cores | Cache (MB) | Memory Speed (MHz) | QPI Speed (CT/s) | Hyper-Threading | vPro | Turbo Boost Technology | TDP (W) |
|---------------------|------------|-------------------|-------|------------|--------------------|------------------|-----------------|------|------------------------|---------|
| Dual-socket capable | E5-2699 v3 | 2.3               | 18    | 45         | 2133               | 9.6              | Yes             | Yes  | Yes                    | 145     |
|                     | E5-2697 v3 | 2.6               | 14    | 35         | 2133               | 9.6              | Yes             | Yes  | Yes                    | 145     |
|                     | E5-2695 v3 | 2.3               | 14    | 35         | 2133               | 9.6              | Yes             | Yes  | Yes                    | 120     |
|                     | E5-2690 v3 | 2.6               | 12    | 30         | 2133               | 9.6              | Yes             | Yes  | Yes                    | 135     |
|                     | E5-2667 v3 | 3.2               | 8     | 20         | 2133               | 9.6              | Yes             | Yes  | Yes                    | 135     |
|                     | E5-2683 v3 | 2.0               | 14    | 35         | 2133               | 9.6              | Yes             | Yes  | Yes                    |         |
|                     | E5-2680 v3 | 2.5               | 12    | 30         | 2133               | 9.6              | Yes             | Yes  | Yes                    | 120     |
|                     | E5-2670 v3 | 2.3               | 12    | 30         | 2133               | 9.6              | Yes             | Yes  | Yes                    | 120     |
|                     | E5-2643 v3 | 3.4               | 6     | 20         | 2133               | 9.6              | Yes             | Yes  | Yes                    | 135     |
|                     | E5-2660 v3 | 2.6               | 10    | 25         | 2133               | 9.6              | Yes             | Yes  | Yes                    | 105     |
|                     | E5-2650 v3 | 2.3               | 10    | 25         | 2133               | 9.6              | Yes             | Yes  | Yes                    | 105     |
|                     | E5-2637 v3 | 3.5               | 4     | 15         | 2133               | 9.6              | Yes             | Yes  | Yes                    | 135     |
|                     | E5-2640 v3 | 2.6               | 8     | 20         | 1866               | 8.0              | Yes             | Yes  | Yes                    | 90      |
|                     | E5-2630 v3 | 2.4               | 8     | 20         | 1866               | 8.0              | Yes             | Yes  | Yes                    | 85      |
|                     | E5-2623 v3 | 3.0               | 4     | 10         | 1866               | 8.0              | Yes             | Yes  | Yes                    | 105     |
|                     | E5-2620 v3 | 2.4               | 6     | 15         | 1866               | 8.0              | Yes             | Yes  | Yes                    | 85      |
|                     | E5-2609 v3 | 1.9               | 6     | 15         | 1600               | 6.4              | No              | Yes  | No                     | 85      |
|                     | E5-2603 v3 | 1.6               | 6     | 15         | 1600               | 6.4              | No              | Yes  | No                     | 85      |
| Single-socket only  | E5-1680 v3 | 3.2               | 8     | 20         | 2133               | N/A              | Yes             | Yes  | Yes                    | 140     |
|                     | E5-1660 v3 | 3.0               | 8     | 20         | 2133               | N/A              | Yes             | Yes  | Yes                    | 140     |
|                     | E5-1650 v3 | 3.5               | 6     | 20         | 2133               | N/A              | Yes             | Yes  | Yes                    | 140     |
|                     | E5-1630 v3 | 3.7               | 4     | 15         | 2133               | N/A              | Yes             | Yes  | Yes                    | 140     |
|                     | E5-1620 v3 | 3.5               | 4     | 10         | 2133               | N/A              | Yes             | Yes  | Yes                    | 140     |
|                     | E5-1607 v3 | 3.1               | 4     | 10         | 1866               | N/A              | No              | Yes  | No                     | 140     |
|                     | E5-1603 v3 | 2.8               | 4     | 10         | 1866               | N/A              | No              | Yes  | No                     | 140     |

## HP Z640 Block Diagram

Figure 1.

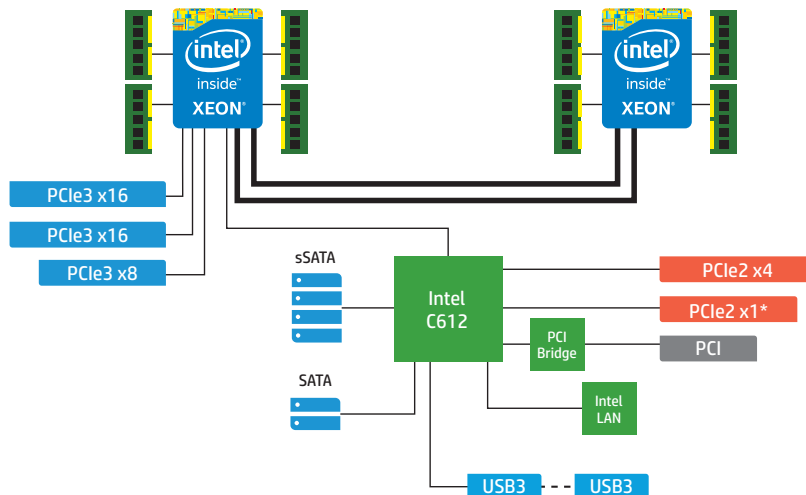

\* Not available when 2nd CPU is present

# I/O slot optimizations

The HP Z640 Workstation utilizes PCI-Express 3.0 technology. This section provides guidance on optimizing the performance of your system when using PCI-Express and PCI cards in the I/O slots.

## Integrated PCI and PCI-Express 3.0

The HP Z640 provides one 32-bit/33 MHz PCI slot that can accommodate a full height, full length PCI card. The HP Z640 uses the Intel® Xeon® processor E5-2600 v3 series, with integrated PCI-Express 3.0 controllers delivering a peak bandwidth of 16 Gb/s per direction. PCI Express 3.0 is backward compatible with 1.0 and 2.0, and slots will train to the highest common speed. PCI Express 3.0 slots will initialize at 1.0 and then transition to 3.0 through a training sequence that involves four adaptive training phases. It is recommended to carefully evaluate and validate PCI-Express 3.0 devices that are not available or supported from HP.

See Figure 1 in previous section for the HP Z640 Workstation Block Diagram

## PCI-Express Performance

The HP Z640 integrates PCIe 3.0 controllers within the processor, DMA caching in the CPU, an integrated 4-channel memory controller, PCIe 3.0 speeds, and a QPI bus speed up to 9.6 GT/s. This produces excellent performance in I/O bandwidth, remote bandwidth, and latency.

**Figure 2.** x16 Peak Bandwidth per Direction—Gb/s

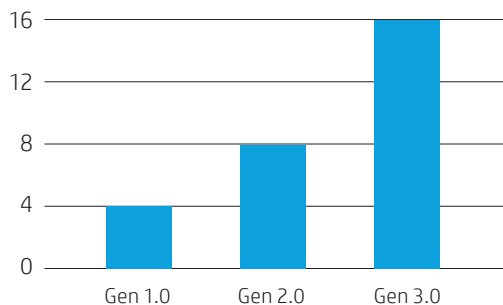



## I/O slot options

In addition to the 32-bit/33 MHz full height and full length PCI slot, the HP Z640 provides a total of up to five high-performance graphics and I/O slots in single CPU configuration and up to four high-performance graphics and I/O slots in Dual CPU configuration, including support for up to two PCIe 3.0 graphics cards in PCIe 3.0 x16 slots. The remaining PCIe slots are open ended and can accommodate a variety of different cards and configurations.

**Figure 3.** I/O slot layout (single CPU configuration)

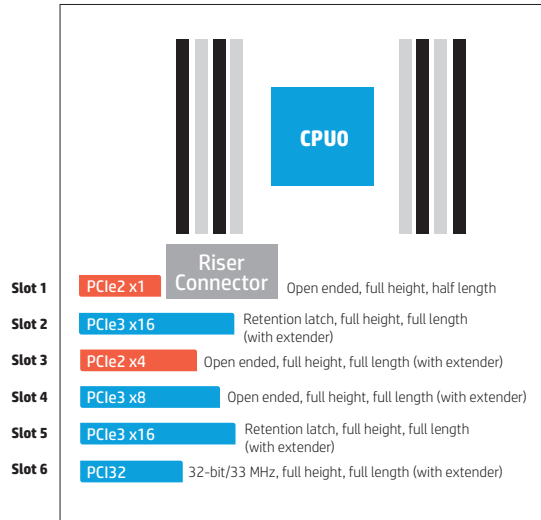

**Figure 4.** I/O slot layout (dual CPU configuration)

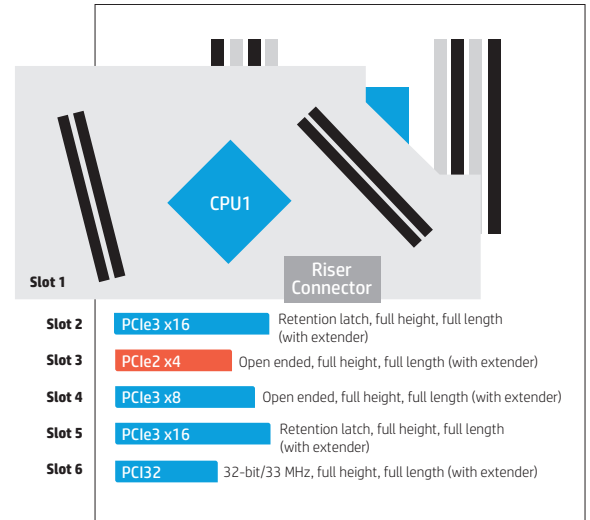

## Recipe for optimizing PCI-Express I/O performance

For high I/O bandwidth applications, the choice of slot loading, CPU, and memory configuration can be optimized to ensure maximum bandwidth available. Applications and cards sensitive to I/O latency may benefit as well from some of the tips below.

### Recommended configuration steps

1. Place Graphics and GPU cards first, following the slot order listed in Table 3.
2. Place I/O cards next, from highest bandwidth to lowest, following the slot order listed in Table 3. This is the optimal load order for most applications.
3. If PCIe 2.0 I/O cards fail to train at full Gen2 speeds (5 Gb/s) in Gen3 slots, then try slot 1 or slot 3 which only trains up to PCIe Gen2.
4. Additional I/O bandwidth refinements may be possible. If necessary, refer to the tips on following page.

**Table 3: HP Z640 I/O slot recommended load order**

| Load priority | Card description           | Load order (depending on slot availability) |           |        |          |           |        |
|---------------|----------------------------|---|-----------|--------|----------|-----------|--------|
|               |                            | Slot 1*                                     | Slot 2    | Slot 3 | Slot 4   | Slot 5    | Slot 6 |
|               |                            | CPU   | PCIe3 x16 |        | PCIe3 x8 | PCIe3 x16 |        |
| Chipset       | PCIe2 x1                   | PCIe2 x4                                    |           | PCI    |          |           |        |
| 1             | Riser Card                 | Only  |           |        |          |           |        |
| 2             | 1st Graphics or GPU        | Only  |           |        |          |           |        |
| 3             | 2nd Graphics or GPU        | Only  |           |        |          |           |        |
| 4             | 3rd Graphics               | Only  |           |        |          |           |        |
| 5             | 4th Graphics               | Only  |           |        |          |           |        |
| 6             | NIC – 10G                  | 4th   | 3rd       |        | 2nd      | 1st       |        |
| 7             | Z Turbo Drive/PCIe storage | 4th   | 3rd       |        | 1st      | 2nd       |        |
| 8             | SAS Card                   | 3rd   | x         |        | 1st      | 2nd       |        |
| 9             | HP Thunderbolt™ 2          | Only  |           |        |          |           |        |
| 10            | NIC < 10G                  | 4th   | 3rd       |        | 2nd      | 1st       |        |
| 11            | Audio                      | 4th   | 3rd       |        | 2nd      | 1st       |        |
| 12            | 1394b                      | 1st   | x         | 2nd    | x        | x         |        |
| 13            | eSATA (Cable)**            | 2nd   | 3rd       |        | 4th      | 1st       |        |
| 14            | Serial port(Cable)**       | 2nd   | 3rd       |        | 4th      | 1st       |        |
| 15            | PCI Card                   | Only  |           |        |          |           |        |

\* Slot 1 is not available when Riser Card is plugged in.

\*\* No electrical connection to PCI and PCIe slots, use any free mechanical slot location.

x Card is not supported in the slot.

## Additional tips

- For applications doing direct bus Peer-to-Peer transfers between cards, load the corresponding cards in slots located behind the CPU. For instance, load cards in slots 2, 4 and 5.
- For very high bandwidth applications in dual CPU systems, select CPU models with the highest QPI frequency (9.6 GT/s).
- Make sure all I/O cards are loaded in slots that have a PCI-Express Lane Width at least as wide as the card (see Table 3).
- For predictable latencies, try disabling NUMA (Non-Uniform Memory Access) mode (BIOS setup menu -> Advanced -> Bus Options -> NUMA = Disabled).
- For cards that are latency sensitive, load these cards in CPU slots.
- Ensure Idle Power Savings BIOS setting is set to Normal (BIOS setup menu -> Power -> OS Power Management -> Idle Power Savings = Normal).
- Use the latest BIOS version available on [hp.com](http://hp.com).
- Check for updates in the latest performance optimization white papers (link below).
- If a configuration has both a double-wide graphics card and a Thunderbolt™ 2<sup>3</sup> card, move the double-wide graphics card from slot 2 to slot 5.

# Storage configurations and RAID

The HP Z640 Workstations includes a 2 port, 6 Gb/s Intel® SATA RAID controller (SATA) and a secondary 4 port, 6 Gb/s Intel® SATA RAID controller (sSATA).

## Storage Features

### Controller interfaces and supported drive types

The controllers support the following drive types and max link speeds:

| Controller | Number of ports | Max link speed | Interface type | Drives supported*      |
|------------|-----------------|----------------|----------------|------------------------|
| SATA       | 2               | 6 Gb/s         | SATA           | SSD, SED, HDD, and ODD |
| sSATA      | 4               | 6 Gb/s         | SATA           | SSD, SED, HDD, and ODD |

\* Some encryption software used with SED drives requires that SATA emulation mode be set to AHCI.

### RAID Levels

The RAID levels supported are shown in the table below:

| Controller | Number of ports | RAID levels | Max RAIDs |
|------------|-----------------|-------------|-----------|
| SATA       | 2               | 0, 1        | 1         |
| sSATA      | 4               | 0, 1, 5, 10 | 2         |

### Option ROM Launch Policy

In the Pre-OS environment, HP Workstations can use either Option ROM (OROM) or a Unified Extensible Firmware Interface (UEFI) driver for configuration and management of the RAID controllers. The default shipping configuration is set to **All Legacy** OROM. This can be changed in BIOS Setup under **Advanced > Option ROM Launch Policy**. Select the desired Option ROM Launch Policy from the pull down menu.

The OROM or UEFI driver is not available when the SATA or sSATA controllers are set to AHCI.

When the Option ROM Launch Policy is set to All Legacy, the SATA and sSATA OROM will only display at power on if there are two or more RAID capable devices attached to the controller, or a single device is attached that contains RAID metadata. In the later case, the OROM will show that the RAID is failed or degraded.

When the Option ROM Launch Policy is set to UEFI, the legacy OROM will not display and management of RAID can be performed in **3rd Party Option ROM Management** from the BIOS **Startup Menu**.

### Controller Enable/Disable

The SATA and sSATA controllers can be Disabled or Enabled individually from the BIOS menu under **Advanced > Device Configurations**. Select Enable or Disable from the pull down menu for the controller that you would like to Enable or Disable.

## Per Port Enable/Disable of SATA ports (SATA and sSATA controllers only)

Individual SATA and sSATA ports can be Disabled or Enabled individually from the BIOS menu under **Advanced > Device Configurations**. Select Enable or Disable from the pull down menu for the Port that you would like to Enable or Disable.

## External SATA (eSATA)

External SATA (eSATA) is supported on the SATA and sSATA controllers with an optional eSATA bulkhead adapter.

Ports can be configured individually as eSATA in the BIOS under **Advanced > Device Configurations > eSATA Port n** under the SATA or sSATA controller. When a port is designated as eSATA, the port link speed may be limited to 3 Gb/s.

An option to eject the drive will be available from the **Windows Taskbar Safely Remove Hardware and Eject Media** applet. Disks included in a RAID array will not be visible in the Eject applet. The current OS disk may be visible in the Eject applet but cannot be ejected. External drives can be hot plugged if the drive is compatible with hot plugging.

Hot plug or Hot unplug and surprise removal/insertion of internal drives is not recommended.

## SATA Emulation Modes

The SATA and sSATA controllers are capable of being set to three different SATA emulation modes. Separate controls are provided for SATA Emulation Mode in the BIOS under **Advanced > Device Configurations > SATA Emulation Mode** and **Advanced > Device Configurations > sSATA Emulation Mode**.

- RAID1 (Default; ACHI + RAID capability with greatest flexibility for most users)
- AHCI (Required when using SEDs)
- IDE (Legacy mode, limited functionality - Not recommended)

## TRIM Support for SSDs

TRIM keeps track of files that have been deleted but not erased on the drive to improve performance and help extend the life of the SSD. TRIM is not an acronym, but is a command specific to SSDs and is typically represented by TRIM in all upper case. TRIM is supported on individual non-RAIDed SSDs on all controllers and is supported on RAID 0 and 1 on the SATA controller and RAID 0, 1, and 10 on the sSATA controller.

## AHCI and RAID<sup>5</sup> Technology

The default SATA emulation mode on HP Workstations is RAID (RAID + AHCI) unless SEDs are installed. If SEDs are installed, the SATA emulation mode will be set to AHCI. The SATA emulation mode can be changed in BIOS setup under **Advanced > Device Configurations**, but changing the mode is not recommended and can result in boot failure<sup>6</sup> or data loss if the SATA emulation mode is changed after the OS is installed or if a volume already contains data. Always back up your data before making any storage system changes.

## RAID+AHCI

RAID+AHCI provides all of the benefits of AHCI with the added flexibility of RAID for configurations needing performance or data redundancy. Even if you don't use RAID today, setting the SATA mode to RAID (RAID+AHCI) makes your system RAID ready for the future. RAID (RAID+AHCI) is the preferred mode and default storage configuration SATA mode set in HP Workstation BIOS.

## AHCI (Advanced Host Controller Interface)

AHCI is a technical standard developed by Intel for the hardware mechanism that allows software to communicate with SATA (Serial ATA) devices. It is enumerated as a PCI device and transfers data between system memory and SATA devices.

AHCI provides many benefits over the legacy IDE (Integrated Drive Electronics) hard drive interface. Some of the benefits include:

- Elimination of master/slave handling.
- Native Command Queuing (NCQ) that allows a SATA device to internally optimize the order of command execution for increased performance.
- TRIM command support for SSDs which keeps track of files that have been deleted but not erased on the drive. This improves performance of the drive and helps extend the life of the SSD by preventing unnecessary writes.

## RAID (Redundant Array of Independent Disks)

RAID provides a method of combining multiple disks into a single logical volume to increase performance or create data redundancy.

**RAID0** – Creates a single volume that has data striped across two or more drives on the same controller. The size of the volume is based on the size of the smallest capacity drive times the number of drives in the RAID0 configuration. RAID0 is typically used to improve performance or create a larger volume from smaller drives. There is no data redundancy or parity in a RAID0 configuration.

**RAID1** – Creates a single volume that is a mirror image of identical data on two physical drives on the same controller. The size of the mirror is limited by the smallest drive used in the RAID1 configuration. This configuration provides data redundancy protection against a single drive failure, does not use parity, and does not improve performance. If a drive fails, the drive can be replaced by a drive of the same capacity or larger capacity to rebuild the RAID array.

**RAID5** – [sSATA controller only] Creates a single volume from three or more physical drives on the same controller. RAID5 uses striping with parity data in distributed blocks across all member disks. A RAID5 volume is tolerant of a single disk failure. RAID5 has performance attributes similar to a RAID0 and reliability of RAID1, however parity calculations can reduce the performance relative to a RAID0.

**RAID10** – [sSATA controller only] Creates a mirror of pairs of drives, and then stripes the data on the mirrored pairs. A RAID10 must contain two or more drive pairs, with a four drive minimum. A RAID10 is fault tolerant to one drive per mirrored pair.

## Creating RAID Arrays on the SATA and sSATA controllers

RAID arrays on SATA and sSATA controllers can be created through Option ROM (OROM) at power on, UEFI driver within **3rd Party Option ROM Management** from the BIOS **Startup Menu**, DOS utilities, EFI shell utilities, Windows command line utilities, or from a graphical user interface (GUI) within the Windows OS.

### 1. Pre-OS RAID creation through the Option ROM (OROM)

In order to use the OROM for configuration of RAID arrays, the **Option ROM Launch Policy** in BIOS must be set to **All Legacy**. This is the default as shipped configuration and can be changed in BIOS Setup under **Advanced > Option ROM Launch Policy**.

To access the OROM, press Ctrl-I as soon as you see Intel® Rapid Storage Technology enterprise - <controller name> Option ROM, where controller name is the name of the controller (either SATA or sSATA) where you want to set up the RAID array.

The OROM will only display at power on if there are two or more RAID capable devices attached to the controller, or a single device is attached that contains RAID metadata. In the later case, the OROM will show that the RAID is failed or degraded.

Once in the OROM, you can Create RAID Volumes, Delete RAID Volumes, Reset Disks to Non-RAID, or Exit. The keys available for use are listed at the bottom of the screen.

Example: RAID volume creation on the SATA or sSATA controllers through OROM.

- a) Use the **Up/Down** arrows to navigate to "1. Create RAID Volume" if not already selected.
- b) Enter the desired volume name and press **Tab** or **Enter**.
- c) Use the **Up/Down** arrows to scroll through available RAID levels. A description of the level will appear in the "HELP" box. Select the desired RAID level and press **Tab** or **Enter**.
- d) Press **Enter** to open the "SELECT DISKS" window.
- e) Use the **Up/Down** arrows to highlight a desired disk and press **Space** to select the disk. Press **Enter** after you have selected all of the disks that you want to be included in the RAID.
- f) If you are creating a RAID array that is striped, you can use the **Up/Down** arrows to change strip size if desired. Press **Enter** when done.
- g) Capacity will be automatically calculated for you based on the RAID type. The capacity shown may be around 95% of the actual available capacity. In a mirrored array, the reserved space helps to ensure that a failed drive can be replaced with another drive of the same listed capacity even if the actual capacity is slightly less than the listed capacity. Press **Enter** to accept the default capacity.
- h) Press **Enter** to create the volume.

Similarly a user can Delete RAID volumes or reset disks to Non-RAID status by following the on screen prompts and using the keys listed at the bottom of each screen.

## 2. RAID creation using the UEFI driver within 3rd Party Option ROM Management in BIOS setup

In order to create RAID arrays using the UEFI driver within 3rd Party Option ROM Management in the BIOS, the **Option ROM Launch Policy** in BIOS must be set to **All UEFI** or **All UEFI Except Video**. This can be changed in BIOS Setup under **Advanced > Option ROM Launch Policy**.

The UEFI driver interface can be reached in BIOS in the following ways:

- Press Esc when powering up the system to enter the BIOS **Startup Menu** and select **3rd Party Option ROM Management**. This will take you directly to the **Drivers** screen where you can select the controller that you want to configure RAID on. If a controller does not have devices attached, it will not show up in the menu.
- Press F3 when powering up the system to enter the **Drivers** screen directly.
- Press F10 when powering up the system to enter BIOS Setup, navigate to UEFI Drivers and select 3rd Part Option ROM Management. This will cause the system to reboot and directly enter the Drivers screen.

Use the **Up/Down** arrows to select the Intel RSTe SATA Controller or Intel RSTe sSATA Controller where your drives are connected. From here you can create a new RAID volume or view existing configurations.

Example: RAID volume creation on SATA or sSATA controllers using the UEFI Driver interface.

- a) Use the **Up/Down** arrows to select **Create RAID Volume** and press **Enter**.
- b) Use the **Up/Down** arrows to select **Name** and press **Enter** to pop up a box for editing the volume name. Change the name if desired and press **Enter** to close the edit box.
- c) Use the **Up/Down** arrows to select **RAID Level** and press **Enter** to show available RAID levels. Use the **Up/Down** arrows to select the desired RAID level and press **Enter** to accept.
- d) Use the **Up/Down** arrows to navigate to "< >" behind the drives you want to include in the array. Press **Enter** to open a selection box and use **Up/Down** arrows to change from blank to "X". Press **Enter** to accept. Continue selecting drives until you have selected all of the drives that you want to include in the RAID array.
- e) Arrays that use striping, will have an option to select strip size. You can accept the default by navigating past it or press **Enter** and make a selection.
- f) Leave the capacity as default.
- g) Use the **Up/Down** arrows to select Create Volume and press **Enter** to create the array. This will take you back to the main screen for the current controller where you can create an additional RAID array (up to 2 arrays) or view already created arrays.

## 3. RAID creation from a DOS or EFI shell.

RAID arrays can be created in a DOS or EFI shell by using the shell specific Intel® RAID Utility for the controller. This is useful in a deployment environment where an organization wants to configure multiple systems identically. The utilities can also be run from a DOS or EFI bootable USB key.

The utilities are specific to a particular driver version and are available with the driver package downloadable from [hp.com](http://hp.com).

The utilities are:

### DOS Shell

- RCfgSata.exe (For the SATA controller)
- RCfgsSata.exe (For the sSATA controller)

### EFI Shell

- RCfgSata.efi (For the SATA controller)
- RCfgsSata.efi (For the sSATA controller)

For the latest commands use “/?” option when executing the command.

Example:

> RCfgSata.exe /? Press **Enter**

Results in:

Intel® RAID Utility for Serial ATA - vn.n.n.nnnn

RCfgSata.exe [/?] [/Y] [/Q] [/C:vol\_name] [/SS:strip\_size] [/L:raid\_level] [/S:vol\_size] [/DS:disk\_id] [/D:vol\_name] [/X] [/I] [/P] [/U] [/ST] [/V]

/? Displays Help Screen. Other options ignored.  
 /Y Suppress any user input. Used with options /C, /D, & /X.  
 /Q Quiet mode/No output. Should not be used with status commands.

**COMMANDS - Only one at a time.**

/C Create a volume with the specified name.  
 /S, /DS, /SS, & /L can be specified along with /C.  
 /SS Specify strip size in KB. Only valid with /C.  
 /L Specify RAID Level (0, 1, 10, or 5). Only valid with /C.  
 /S Specify volume size in GB or percentage if a ‘%’ is appended.

**Percentage must be between 1-100. Only valid with /C.**

/DS Selects the disks to be used in the creation of volume.

**List should be delimited by spaces.**

/D Delete Volume with specified name.  
 /X Remove all metadata from all disks. Use with /DS to delete metadata from selected disks.  
 /I Display All Drive/Volume/Array Information. /P can be specified.  
 /P Pause display between sections. Only valid with /I or /ST.  
 /U Do not delete the partition table. Only valid with /C on RAID 1 volumes.  
 /ST Display Volume/RAID/Disk Status.  
 /V Display version information.

**4. RAID creation from a Windows Administrator Command Prompt.**

RAID arrays can be created by using the Intel® Rapid Storage Technology enterprise (RSTe) Command Line Interface (RSTCLI) for 32-bit and 64-bit Windows operating systems. RSTCLI is included in the Intel® RSTe driver package for your system, downloadable from hp.com. The RSTCLI must be executed from an administrator command prompt. If you attempt to execute the RSTCLI utility from a non-administrator command prompt, you will receive the following message: “Could not obtain system information to display middleware version.”

See the **RSTe CLI Specification** included with the RSTCLI for specific usage instructions.

**5. RAID creation from within the OS using the Intel® Rapid Storage Technology enterprise GUI.**

The RSTe GUI provides an easy method for creating RAID arrays. The RSTe GUI is pre-installed on systems shipped from the factory, and can also be installed from the latest driver package available on hp.com.

Launch Intel® Rapid Storage Technology enterprise GUI by navigating to it from the start menu, or press the **Windows** key and then start typing “Intel” in the Box that appears. A short list should appear that contains “Intel Rapid Storage Technology enterprise”. Click this item with the mouse to launch the GUI.

Click the “Create Volume...” button to start the guided RAID array creation process. Additional help is available on each page of RAID creation process by clicking on “More help on this page” at the lower right corner of each page. A balloon with a question mark inside will be displayed if help or suggestions are available for a specific topic. Click on the balloon to display the help on the item in a new page.



## Performance Considerations

### Power Settings

The default “Balanced” and “Power Saver” plans in Windows Power Options may result in power management settings that may adversely affect performance of your applications. If the workstation is being used for a high demand application, consider choosing the “High performance” power plan or choose custom settings that better fit your use model.

### SSDs used in RAID configurations and TRIM support

TRIM keeps track of files that have been deleted but not erased on the drive to improve performance and help extend the life of the SSD. As the SSD is used, the controller within the SSD distributes data across the available FLASH on the SSD until all FLASH is used. After the FLASH has been used up, a block erase is required before subsequent writes can occur. The TRIM command normally frees up memory prior to being needed for the next write. If the TRIM commands are not sent to the drive and no unerased FLASH is available for writing, the SSD controller must erase a block of memory prior to writing. This can slow performance in applications that perform a lot of file write and file delete operations. One example is in compiling code where the compiler generates many intermediate files that then get deleted.

The table below shows which RAID arrays support TRIM:

| Controller | TRIM supported | TRIM not supported |
|------------|----------------|--------------------|
| SATA       | 0, 1           |                    |
| sSATA      | 0, 1, 10       | 5                  |

### Storage Caching Options

HP Workstations ship with default storage cache settings that balance performance with data protection. The balance of performance and protection can be adjusted by changing one or more of these settings.

*Create a backup of your data before attempting to change any storage related settings.*

#### Windows Write-caching policy (Disk Properties in Disk Manager)

Write caching on the device:

DEFAULT: Enabled

Improves performance by enabling write caching on the disk; however, a loss of power may result in loss of data that has not been committed to the storage media.

Windows write-cache buffer flushing:

DEFAULT: Enabled

When enabled, Windows will periodically instruct the storage device to commit data in the devices cache to the non-volatile storage media. These periodic commands result in decreased overall system performance.

Note: If Windows write-cache buffer flushing is enabled, Intel® RSTe write-back cache is disabled. To enable write-back cache on volumes, you must disable Windows write-cache buffer flushing.

A user can choose to disable Windows write-cache buffer flushing to restore system performance, allowing the Intel® RSTe driver to handle all write-cache buffer flushing.

#### Intel® RSTe write-back cache [for RAID volumes] (Intel RSTe GUI, Volume Properties)

DEFAULT: Disabled

When enabled, the read and write performance of a RAID or recovery volume is improved. In write-back cache mode, the RAID controller acknowledges write I/O requests immediately after the data loads into the controller cache. The application can continue working without waiting for the data to be physically written to the hard drives.

Enabling Intel® RSTe write-back cache will enable Write caching on the device if not already enabled and will disable Windows write-cache buffer flushing.

# Memory Configurations and Optimization

The purpose of this section is to provide an overview of the memory configurations for the HP Z640 Workstation and to provide recommendations to optimize performance.

## Supported memory modules

### Types of memory supported on an HP Z640 are:

- 4 GB, 8 GB and 16 GB PC4-2133R 2133 MHz DDR4 Registered DIMMs
- 32 GB PC4-2133L 2133 MHz DDR4 Load Reduced (LR) DIMMs
  - 32 GB LR DIMMs are expected to be available early 2015
- Single and dual rank 4 GB and 8 Gb based RDIMMs are supported
- Quad rank 4 GB based LR DIMMs are supported

### Types of memory NOT supported on an HP Z640 are:

- Unbuffered DIMMs
- Non-ECC DIMMs
- DDR, DDR2, or DDR3 DIMMs

**See Memory Technology White Paper for more memory module technical information.**

## Platform capabilities

### Maximum capacity

- Single processor: 64 GB at launch
  - 128 GB when 32 GB LR DIMMs are available
- Dual processors: 128 GB at launch
  - 256 GB when 32 GB LR DIMMs are available

### Total of 8 memory sockets

- 4 sockets on the motherboard: 4 channels per processor and 1 socket per channel
- 4 sockets on the 2nd CPU and memory module: 4 channels per processor and 1 socket per channel

### Speed

- 2133 MHz, 1866 MHz and 1600 MHz memory speeds are supported in this platform.
- Memory will operate at the speed of the slowest rated installed processor or DIMM.

### Registered and LR DIMMs cannot be mixed in a system

### Dynamic power saving is enabled

### NUMA and Non-NUMA modes are supported and user configurable

## Memory features

### ECC is supported on all of our supported DIMMs

- Single-bit errors are automatically corrected.
- Multi-bit errors are detected and will cause the system to immediately reboot and halt with an F1 prompt error message.
- Non-ECC memory does not detect or correct single-bit or multi-bit errors which can cause instability, or corruption of data, in the platform. See Memory Technology White Paper for more information.

### Command and Address parity is supported

- Command and Address errors are detected and will cause the system to immediately reboot and halt with an F1 prompt error message.

## Optimize performance

Generally, maximum memory performance is achieved by evenly distributing total desired memory capacity across all operational channels. Proper individual DIMM capacity selection is essential to maximizing performance. On the second CPU, installing the same amount of memory as the first CPU will optimize performance. Refer to Optimal configurations tables below for more information.

**Table 4: Optimal configurations for HP Z640 (Note: The following tables do not include all available orderable configurations)**

|               | Notes | DIMM1          | CPU0 DIMM3 | DIMM6 | DIMM8          | Rating       |
|---------------|-------|----------------|------------|-------|----------------|--------------|
| <b>4 GB</b>   | *     | 4 GB           |            |       |                | Fair         |
| <b>8 GB</b>   |       | 4 GB<br>8 GB   |            |       | 4 GB           | Good<br>Fair |
| <b>12 GB</b>  |       | 4GB            | 4GB        |       | 4GB            | Better       |
| <b>16 GB</b>  |       | 4 GB<br>8 GB   | 4 GB       | 4 GB  | 4 GB<br>8 GB   | Best<br>Good |
| <b>24 GB</b>  | ~     | 8 GB           | 4 GB       | 4 GB  | 8 GB           | Better       |
| <b>32 GB</b>  |       | 8 GB<br>16 GB  | 8 GB       | 8 GB  | 8 GB<br>16 GB  | Best<br>Good |
| <b>48 GB</b>  | ~     | 16 GB          | 8 GB       | 8 GB  | 16 GB          | Better       |
| <b>64 GB</b>  |       | 16 GB<br>32 GB | 16 GB      | 16 GB | 16 GB<br>32 GB | Best<br>Good |
| <b>128 GB</b> |       | 32 GB          | 32 GB      | 32 GB | 32 GB          | Best         |

**Table 5:**

|               | Notes | CPU0                 |            |       |                | CPU1                  |            |       |                | Rating               |
|---------------|-------|----------------------|------------|-------|----------------|-----------------------|------------|-------|----------------|----------------------|
|               |       | DIMM1                | CPU0 DIMM3 | DIMM6 | DIMM8          | DIMM1                 | CPU1 DIMM3 | DIMM6 | DIMM8          |                      |
| <b>8 GB</b>   |       | 4 GB                 |            |       |                | 4 GB                  |            |       |                | Fair                 |
| <b>16 GB</b>  |       | 4 GB<br>8 GB         |            |       | 4 GB           | 4 GB<br>8 GB          |            |       | 4 GB           | Good<br>Fair         |
| <b>32 GB</b>  |       | 4GB<br>8 GB<br>16 GB | 4GB        | 4 GB  | 4GB<br>8 GB    | 4 GB<br>8 GB<br>16 GB | 4 GB       | 4 GB  | 4 GB<br>8 GB   | Best<br>Good<br>Fair |
| <b>48 GB</b>  |       | 8 GB                 | 4 GB       | 4 GB  | 8 GB           | 8 GB                  | 4 GB       | 4 GB  | 8 GB           | Better               |
| <b>64 GB</b>  | ~     | 8 GB                 | 8 GB       | 8 GB  | 8 GB           | 8 GB                  | 8 GB       | 8 GB  | 8 GB           | Best                 |
| <b>96 GB</b>  |       | 16 GB                | 16 GB      | 16 GB | 16 GB          | 16 GB                 | 16 GB      | 16 GB | 16 GB          | Better               |
| <b>128 GB</b> | ~     | 16 GB<br>32 GB       | 16 GB      | 16 GB | 16 GB<br>32 GB | 16 GB<br>32 GB        | 16 GB      | 16 GB | 16 GB<br>32 GB | Best<br>Good         |
| <b>256 GB</b> |       | 32 GB                | 32 GB      | 32 GB | 32 GB          | 32 GB                 | 32 GB      | 32 GB | 32 GB          | Best                 |

\* Maximum memory capacities assume Windows 64-bit operating systems or Linux. With Windows 32-bit operating systems, memory above 3 GB may not all be available due to system resource requirements.

~ Although supported, these configurations are not orderable at this time.

## Loading rules

- Load the memory modules in order of size, starting with the largest module and finishing with the smallest module.
- For a single processor configuration, the DIMMs should be loaded starting with the DIMM furthest from the CPU, with the first DIMM loaded in the socket on the right side of the system and alternating sides of the CPU.
- For a dual processor configuration, follow the loading order above, but alternate between the two processors.
- See figures below for loading order.

**Figure 5.** Loading order

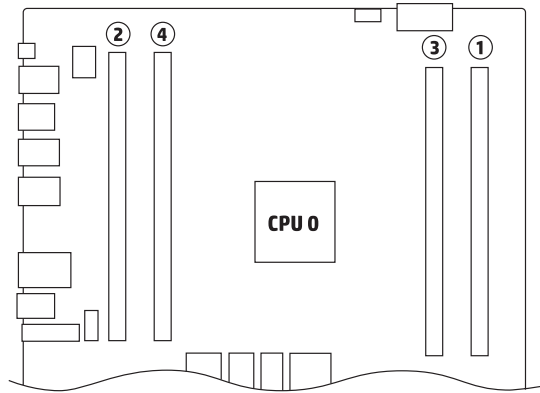

**Figure 6.** Loading order for dual CPU configurations

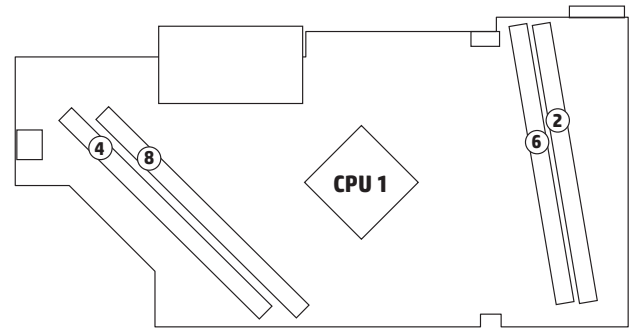
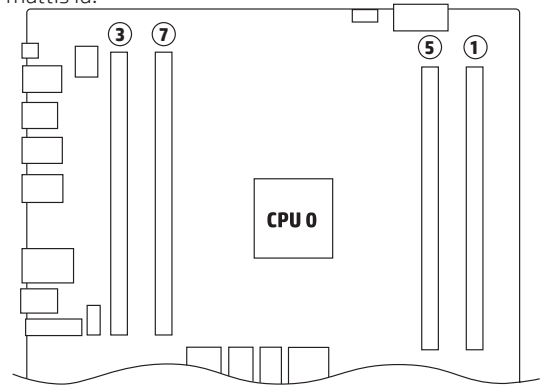

# New UEFI BIOS and features/ legacy support

This section describes the new features of the HP firmware (BIOS) installed on the HP Z640 Workstation. Additional information is available in the Maintenance and Service Guide for this workstation.

## New BIOS core

The HP Z440, Z640, and Z840 Workstations all share the same BIOS image, for which the family name is M60. The M60 BIOS is the first to use a new common core that will be shared with HP Commercial Desktops and Notebooks.

## Compatibility

The M60 BIOS implements UEFI 2.4, Platform Initialization (PI) 1.3, ACPI 5.0, and SMBIOS 3.0.

The M60 BIOS is capable of running both UEFI and legacy operating systems (what the UEFI Forum calls “class 2 firmware”), without reconfiguration to switch from one to the other. However, when Secure Boot is enabled, only UEFI operating systems that comply with Secure Boot can be launched.

## New BIOS tools

The new BIOS core will require the following new tools:

- **UefiBiosConfig.efi** – Captures/sets BIOS features from the EFI shell (replaces Repsetup.exe)
- **Hp-repsetup** – Captures/sets BIOS features from Linux
- **HPBIOSUPDREC.exe** – Updates BIOS from Windows
- **hp-flash** – Updates BIOS from Linux
- **CustomLogoApp.efi** – EFI custom logo tool

The tools will be available via SoftPaqs from [hp.com](http://hp.com) under the HP Z640 Workstation support page.

## New Computer Setup graphical interface

The Computer Setup (“F10 Setup”) user interface is now graphical, with variable-width text, drop-down boxes for item selection, and mouse support.

**Figure 1 - Main screen in HP Computer Setup**

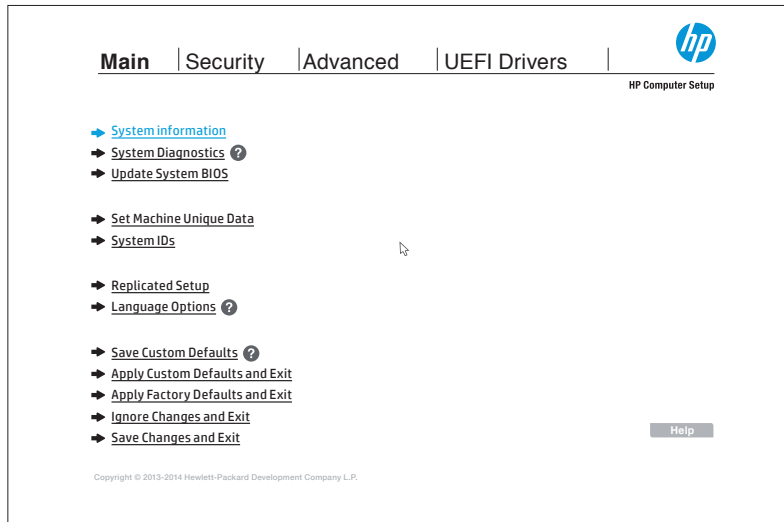

Computer Setup is available in 14 languages: English, German, Spanish, Italian, French, Japanese, Portuguese, Danish, Finnish, Dutch, Norwegian, Swedish, simplified Chinese, and traditional Chinese. The keyboard layout can now be configured independently of the language.

## Boot modes

The M60 BIOS has separate grouped enable settings for UEFI boot options and legacy boot options.

Legacy support and Secure Boot are now combined in a single setting, in the Advanced menu.

The option ROM launch policy has also been combined in a single setting, with the following options: “all UEFI”, “all legacy”, and “all UEFI except video”. The last option is useful for running Windows 7 in UEFI mode.

## NVMe support

The M60 BIOS natively supports booting from NVMe Express (NVMe), which allows PCI-Express-based Solid-State Drives (SSDs). NVMe provides greatly improved performance compared to AHCI, the interface used by SATA drives.

## Network BIOS update

Network BIOS update allows users or administrators to download and install BIOS updates from remote servers, within Computer Setup. It also allows administrators to set up automatic checks for updates at programmable intervals, e.g. weekly. Administrators can set up their own update servers and update policy.

Details on network BIOS update are available in appendix B of the technical white paper called “HP Business Notebook and Desktop PC F10 Setup overview”, available at [h20195.www2.hp.com/V2/GetPDF.aspx/4AA5-2078ENW.pdf](http://h20195.www2.hp.com/V2/GetPDF.aspx/4AA5-2078ENW.pdf).

## Resources, contacts, or additional links

This site includes white papers on **USB 3.0 Technology, Battery Charging technology, Thunderbolt™ 2 Technology, etc.**  
[hp.com/go/whitepapers](http://hp.com/go/whitepapers)

## New performance settings

### Processor snoop modes

The Xeon E5 v3 processor supports four different snoop modes: Early Snoop (also known as: ES mode), Home Snoop (a.k.a.: HS mode, Broadcast Snoop), Home Directory Snoop (a.k.a.: Directory Snoop, Directory Mode, HD Snoop), Home Directory OSB Snoop (OSB = Opportunistic Snoop Broadcast) (a.k.a.: Directory OSB, Opportunistic Snoop). The M60 BIOS allows Early Snoop and Home Snoop.

## Security defaults

Security settings have a separate default, accessed from the BIOS GUI under the Security menu.

## New Secure Boot key

The Secure Boot key exchange key (KEK) used to sign HP UEFI applications has been updated. HP-signed applications using the older KEK will not run when Secure Boot is enabled; this includes older versions of HP offline diagnostics. The two KEKs common to all vendors (Microsoft Windows and UEFI CA) are unchanged.

## Changes to replacement motherboards

All motherboard replacements will prompt the user to enter specific information (e.g. the serial number) upon first boot. The system will not accept BIOS passwords and will require user intervention to boot to an OS until the requested information is entered by the end user.

The M60 BIOS also supports System Manufacturing Commands (SMC), which can be used to modify settings normally accessible at the factory. SMCs can only run on predetermined units for predetermined purposes and are digitally signed to prevent from tampering. There is a Computer Setup option to disable SMCs.

\* Not all features are available in all editions or versions of Windows. Systems may require upgraded and/or separately purchased hardware, drivers and/or software to take full advantage of Windows functionality. See [microsoft.com](http://microsoft.com).

1. This product is low-halogen except for power cords, cables, and peripherals. The following customer-configurable internal components may not be low-halogen: 3.5" SAS HDDs, LSI9270-8i SAS ROC RAID Card, and LSI 9217-4i4e SAS ROC RAID Card. Service parts obtained after purchase may not be low-halogen.
2. Maximum memory capacities assume Windows 64-bit operating systems or Linux. With Windows 32-bit operating systems, memory above 3 GB may not all be available due to system resource requirements.
3. Thunderbolt is new technology. Thunderbolt cable and Thunderbolt device (sold separately) must be compatible with Windows. To determine whether your device is Thunderbolt Certified for Windows, see [thunderbolttechnology.net/products](http://thunderbolttechnology.net/products).
4. Some vPro functionality, such as Intel® Active management technology and Intel Virtualization technology, requires additional 3rd party software in order to run. Availability of future "virtual appliances" applications for Intel vPro technology is dependent on 3rd party software providers. Microsoft Windows required.
5. SATA hardware RAID is not supported on Linux systems. The Linux kernel, with built-in software RAID, provides excellent functionality and performance. It is a good alternative to hardware-based RAID. Please visit [h20000.www2.hp.com/bc/docs/support/SupportManual/c00060684/c00060684.pdf](http://h20000.www2.hp.com/bc/docs/support/SupportManual/c00060684/c00060684.pdf) for RAID capabilities with Linux.
6. Advisory: HP Z-Series Workstation - Manual Windows 7 Operating System Installation May Fail. Document ID: c03255662 h20566.  
[www2.hp.com/portal/site/hpsc/template.PAGE/public/kb/docDisplay/?javax.portlet.begCacheTok=com.vignette.cachetoken&javax.portlet.endCacheTok=com.vignette.cachetoken&javax.portlet.prp\\_ba847bafb2a2d782fcbb0710b053ce01=wsrp-navigationalState%3DdocId%253Demr\\_na-c03255662-7%257CdocLocale%253D%257CcalledBy%253D&javax.portlet.tpst=ba847bafb2a2d782fcbb0710b053ce01&sp4ts.oid=5225037&ac.admitted=1402961079483.876444892.199480143](http://www2.hp.com/portal/site/hpsc/template.PAGE/public/kb/docDisplay/?javax.portlet.begCacheTok=com.vignette.cachetoken&javax.portlet.endCacheTok=com.vignette.cachetoken&javax.portlet.prp_ba847bafb2a2d782fcbb0710b053ce01=wsrp-navigationalState%3DdocId%253Demr_na-c03255662-7%257CdocLocale%253D%257CcalledBy%253D&javax.portlet.tpst=ba847bafb2a2d782fcbb0710b053ce01&sp4ts.oid=5225037&ac.admitted=1402961079483.876444892.199480143)

© Copyright 2014–2015 Hewlett-Packard Development Company, L.P. The information contained herein is subject to change without notice. The only warranties for HP products and services are set forth in the express warranty statements accompanying such products and services. Nothing herein should be construed as constituting an additional warranty. HP shall not be liable for technical or editorial errors or omissions contained herein.

Intel, Xeon, vPro, and Thunderbolt are trademarks of Intel Corporation in the U.S. and other countries. ENERGY STAR is a registered mark owned by the U.S. government. All other trademarks are the property of their respective owner.

