

Dell P2424HEB

Video Conferencing Monitor

User's Guide

Model: P2424HEB
Regulatory model: P2424HEBt





NOTE: A NOTE indicates important information that helps you make better use of your computer.



CAUTION: A CAUTION indicates potential damage to hardware or loss of data if instructions are not followed.



WARNING: A WARNING indicates a potential for property damage, personal injury, or death.

Copyright © 2023-2024 Dell Inc. or its subsidiaries. All rights reserved. Dell, EMC, and other trademarks

are trademarks of Dell Inc. or its subsidiaries. Other trademarks may be trademarks of their respective owners.

2024 – 05

Rev. A01

Contents

Safety instructions	6
About your monitor	7
Package contents	7
Product features	8
Operating system compatibility	9
Identifying parts and controls	10
Front view	10
Back view	13
Bottom view	14
Monitor specifications	16
Resolution specifications	18
Preset display modes	18
DP Multi-Stream Transport (MST) Modes	19
USB-C Multi-Stream Transport (MST) Modes	19
Unified Communications (UC) Platform Compatibility List	20
Electrical specifications	21
Webcam specifications	22
Speaker specifications	22
Microphone specifications	22
Physical characteristics	22
Environmental characteristics	24
Pin assignments	26
Plug-and-Play capability	34
LCD monitor quality and pixel policy	34
Ergonomics	35
Handling and moving your display	37
Maintenance guidelines	38
Cleaning your monitor	38



Setting up the monitor	40
Attaching the stand	40
Using the tilt, swivel, and vertical extension	43
Tilt, swivel and vertical extension	43
Rotating the Display	44
Configuring the display settings on your computer after rotation	45
Camera Image Rotation	45
Connecting your monitor	46
Dell Power Button Sync (DPBS)	51
Connecting the monitor for DPBS for the first time	53
Using DPBS function	54
Connecting the monitor for USB-C Multi-Stream Transport (MST) function in DPBS mode	56
Connecting the monitor for USB-C in DPBS mode	57
Organizing your cables	59
Operating the monitor webcam	60
Dell Peripheral Manager	61
Securing your monitor using Kensington lock (optional)	61
Removing the monitor stand	62
Wall mounting (Optional)	63
Operating the monitor	64
Power on the monitor	64
Using the joystick control	64
Using the rear-panel controls	65
Front-panel button	67
Using the Main Menu	68
Using the OSD lock function	81
Initial Setup	84
OSD warning messages	85
Setting the maximum resolution	88
Multi-Monitor Sync (MMS)	89



Setting Multi-Monitor Sync (MMS)90
Setting up Windows Hello	91
Setting up the monitor webcam as default setting on the operating system	95
Setting up the monitor speaker as default setting on the operating system	100
Use case of monitor speaker and microphone	102
Troubleshooting	104
Self-test104
Built-in diagnostics105
Common Problems.106
Product specific problems108
Microsoft® Teams®/Skype for Business® specific problems117
Universal Serial Bus (USB) specific problems119
Regulatory information	120
FCC notices (U.S. Only) and other regulatory information.120
EU product database for energy label and product information sheet120
Contacting Dell.	121



Safety instructions

Use the following safety guidelines to protect you monitor from potential damage and to ensure your personal safety. Unless otherwise noted, each procedure included in this document assumes that you have read the safety information that shipped with your monitor.



NOTE: Before using the monitor, read the safety information that is shipped with your monitor and printed on the product. Keep the documentation at a secure location for future reference.



WARNING: Use of controls, adjustments, or procedures other than those specified in this documentation may result in exposure to shock, electrical hazards, and/or mechanical hazards.



WARNING: The possible long-term effect of listening to audio at high volume through the headphones (on monitor that support it) may cause damage to your hearing ability.

- Place the monitor on a solid surface and handle it carefully. The screen is fragile and can be damaged if dropped or hit with a sharp object.
- Ensure that your monitor is electrically rated to operate with the AC power available in your location.
- Keep the monitor in room temperature. Excessive cold or hot conditions can have an adverse effect on the liquid crystals of the display.
- Connect the power cable from the monitor to a wall outlet that is near and accessible. See [Connecting your monitor](#).
- Do not place and use the monitor on a wet surface or near water.
- Do not subject the monitor to severe vibration or high impact conditions. For example, do not place the monitor inside a car trunk.
- Unplug the monitor when it is going to be left unused for an extended period.
- To avoid electric shock, do not attempt to remove any cover or touch the inside of the monitor.
- Read these instructions carefully. Keep this document for future reference. Follow all warnings and instructions marked on the product.
- Certain monitors can be wall mounted using the VESA mount that is sold separately. Ensure to use the correct VESA specifications as mentioned in the wall mounting section of the User's Guide.

For information on safety instructions, see the Safety, Environmental, and Regulatory Information (SERI) document that is shipped with your monitor.



About your monitor



Package contents

The following table provides the list of components that are shipped with your monitor. If any component is missing, contact Dell. For more information, see [Contact Dell](#).

 **NOTE: Some items may be optional and may not ship with your monitor. Some features may not be available in certain countries.**

Component image	Component description
	Display
	Stand riser
	Stand base
	Power cable (varies by country)
	DisplayPort 1.8 M cable (DisplayPort to DisplayPort)

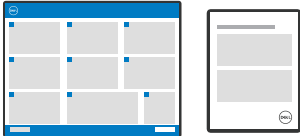

	USB 3.2 Gen1 1.8 M Type-A to Type-B upstream cable
	USB-C® Gen1 1.8 M cable (C to C)
	<ul style="list-style-type: none"> • Quick Setup Guide • Safety, Environmental, and Regulatory Information

Product features

The **Dell P2424HEB** monitor has an active matrix, Thin-Film Transistor (TFT), Liquid Crystal Display (LCD), and LED backlight. The monitor features include:

- 60.47 cm (23.8 in.) active area display (measured diagonally) 1920 x 1080 (16:9) resolution, plus full-screen support for lower resolutions.
- Wide viewing angles with 99% sRGB color.
- Tilt, swivel, pivot and vertical extension adjustment capabilities.
- Built-in speakers (2 x 5 W).
- Removable pedestal stand and Video Electronics Standards Association (VESA™) 100 mm mounting holes for flexible mounting solutions.
- Ultra-thin bezel minimizes the bezel gap during multi-monitor usage, enabling easier set up with an elegant viewing experience.
- Extensive digital connectivity with DP helps future-proof your monitor.
- Single USB Type-C® to supply power to compatible notebook while receiving video signal.
- USB-C and RJ45 ports enable a single-cable, network-connected experience.
- Plug and play capability if supported by your computer.
- On-Screen Display (OSD) adjustments for ease of set-up and screen optimization.
- Power and OSD buttons lock.
- Security lock slot.
- Stand lock.
- The monitor is designed with Dell Power Button Sync (DPBS) feature to control PC system power state from monitor power button.*



- The Monitor allows multiple monitors that are daisy chained via DisplayPort to synchronize a pre-defined group of OSD settings in the background by Multi-Monitor Sync (MMS).
 - Premium Panel Exchange for peace of mind.
 - Optimize eye comfort with a flicker-free screen and ComfortView Plus feature.
 - This monitor uses low blue light panel. When the monitor is reset to factory settings or default setting (Preset mode: Standard), it works in compliance with TUV Rheinland (hardware solutions provider).
 - Decreases the level of hazardous blue light emitted from the screen to make viewing more comfortable for your eyes.
 - The monitor adopts Flicker-Free technology, which clears the eye-visible flicker, brings comfort viewing experience and prevents users from suffering eye strain and fatigue.
 - Certified for Microsoft Teams® and Zoom®.
 - Certified for Windows Hello® (Face Authentication) and supports Microsoft Cortana®.
 - Additional customization using Dell Peripheral Manager/Dell Display Manager (DDM) for Windows operating system and Dell Display and Peripheral Manager (DDPM) for Mac operating system.
- * Dell system that supports DPBS is listed in Dell website. DPBS function can be enabled in OSD menu under Display.

⚠ WARNING: The possible long-term effects of blue light emission from the monitor may cause damage to the eyes, which includes but is not limited to eye fatigue and digital eyestrain. ComfortView Plus feature is designed to reduce the amount of blue light emitted from the monitor to optimize eye comfort.

Operating system compatibility

- Windows 10 Version 21H2 and Windows 11 Version 21H2*
- macOS 12.4*

*The operating system compatibility on Dell and Alienware branded monitors may vary based on factors such as:

- Specific release date(s) when operating system versions, patches, or updates are available.
- Specific release date(s) when Dell and Alienware branded monitor firmware, software application, or driver updates are available on the Dell support website.



Identifying parts and controls

Front view

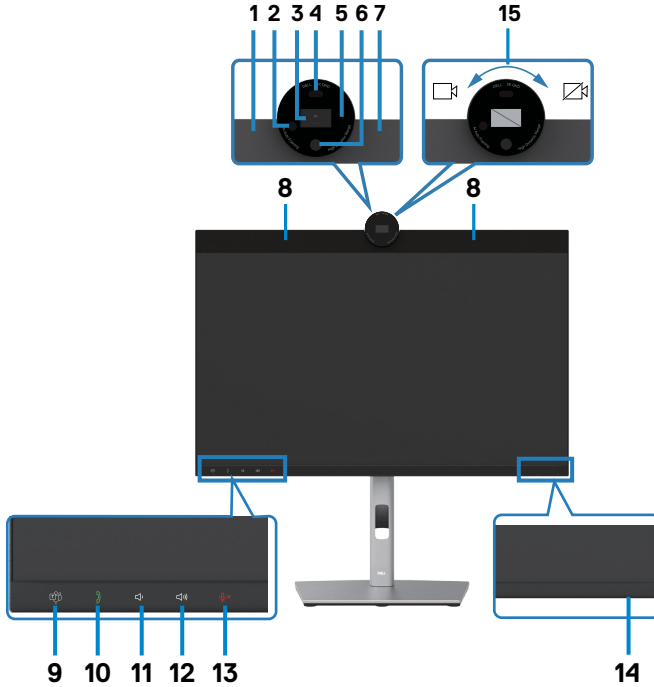

Label	Description	Use
1,7	Microphones	Monitor microphones (Mic).
2	IR LED	Indicator of infrared (IR).
3	RGB Camera	Transmits your image in a video conference.
4	Proximity Sensor	Supports the human presence wake & lock feature.
5	Webcam LED indicator	Indicator of Webcam. It will light up in white when webcam is in use.
6	IR Camera	Supports the face recognition feature.
8	Built-in speakers	To output the sound from audio input.



9	Teams button & LED	<p>LED will light in static white when Microsoft Teams® is signed in and running.</p> <p>LED will blink when there is a Teams notification.</p> <p>Short press on the button to bring up Teams and open notification. Ensure that the Teams application is signed in and is already running at the background.</p> <p>NOTE: For the Teams button to work, ensure that the Teams account is provisioned/setup as 'Teams Only' mode. The tenant administrator should enable the account to 'Teams Only' mode.</p> <p>NOTE: Teams button will only work with Teams application in 'Teams Only' mode. Setting might vary in corporate environment, resulting in Teams button not working on the monitor. Please check with your system administrator.</p>
10	Hookswitch & LED	<p>LED will blink in green when there is an incoming Teams/Skype for Business (SfB) call.</p> <p>LED will light up in static green during Teams/Skype for Business (SfB) call.</p> <p>Short press to answer/end call.</p> <p>Long press to reject incoming call.</p>
11	Volume down & LED	<p>Short press for 2 unit volume decrement.</p> <p>Long press for continuous volume decrement.</p>
12	Volume up & LED	<p>Short press for 2 unit volume increment.</p> <p>Long press for continuous volume increment.</p>
13	Microphone mute & LED	<p>Press to mute and unmute microphone.</p> <p>LED will light up in static red when mic is muted.</p> <p>LED will go dark when mic is enabled/unmuted.</p>
14	Power LED indicator	<p>Solid white light indicates the monitor is turned on and functioning normally. Breathing white light indicates the monitor is in Standby Mode.</p>



15	Camera Shutter Close/Open	<p>Rotate clockwise to close camera shutter. When closed, the camera will replace the image with a black pattern.</p> <p>Rotate counterclockwise to open camera shutter. When opened, UC applications can open camera function to use the camera when it is needed.</p> <p>NOTE: The close camera shutter is different from the disable 'Webcam & Presence Sensor' in OSD menu. Disabling 'Webcam & Presence Sensor' will turn off the whole webcam module, hence webcam and sensor will not appear in the system.</p>
----	------------------------------	---



Back view







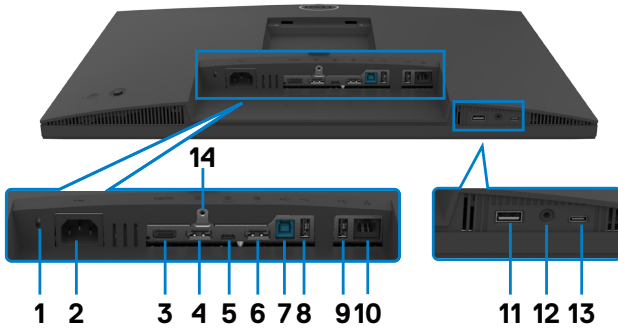

Label	Description	Use
1	VESA mounting holes (100 mm x 100 mm-behind attached VESA cover)	Wall mount monitor using VESA-compatible wall mount kit (100 mm x 100 mm).
2	Regulatory label	Lists the regulatory approvals.
3	Stand release button	Releases stand from the monitor.
4	Power On/Off button	To turn the monitor on or off.
5	Joystick	Use it to control the OSD menu. For more information, see Operating the Monitor .
6	Mac Address, Barcode, serial number, and Service Tag label	Refer to this label if you need to contact Dell for technical support. The Service Tag is a unique alphanumeric identifier that enables Dell service technicians to identify the hardware components in your computer and access warranty information.
7	Cable-management slot	Use to organize cables by inserting them through the slot.









Bottom view



Label	Description	Use
1	Security lock slot (based on Kensington Security Slot™)	Secures monitor with security cable lock (sold separately).
2	 Power connector	Connect the power cable.
3	HDMI HDMI port	Connect your computer with the HDMI cable.
4	 DisplayPort (in)	Connect your computer with the DisplayPort cable.
5	 USB Type-C upstream/ DisplayPort (Video + data)	Connect to your computer using the USB Type-C cable. The USB Type-C port offers the fastest transfer rate (USB 3.2 Gen1) and the alternate mode with DP 1.2 supporting maximum resolution of 1920 x 1080 at 60 Hz, PD 20 V/4.5 A, 15 V/3 A, 9 V/3 A, 5 V/3 A. NOTE: USB Type-C is not supported on Windows versions that are prior to Windows 10.
6	 DP port (out) 	DP output for MST (multi-stream transport) capable monitor. To enable MST, refer to instruction on section “Connecting the Monitor for DP MST Function” . NOTE: Remove the rubber plug when using DP out connector.
7	 USB-B upstream port	Connect the USB cable that comes with your monitor to the computer. Once this cable is connected, you can use the USB downstream connectors on the monitor.



<p>8,9,11</p>	 <p>Super speed USB 5 Gbps (USB 3.2 Gen1) (3)</p>	<p>Connect your USB device. You can use these ports only after you have connected the USB cable (Type-A to Type-B or Type-C to Type-C) from the computer to the monitor. Port with  battery icon supports Battery Charging Rev. 1.2.</p>
<p>10</p>	 <p>RJ45 connector</p>	<p>Connect to Internet. You can surf Internet via RJ45 only after you have connected the USB cable (Type-A to Type-B or Type-C to Type-C) from the computer to the monitor.</p>
<p>12</p>	 <p>3.5 mm Combo Headphone with microphone jack</p>	<p>Connect headphones or headset through HDMI or DisplayPort or USB Type-C audio channels. To use the microphone function, ensure a USB upstream cable is connected and select Echo Cancelling Speakerphone audio path in the Sound setting interface. Headphone jack supports headset with microphone. NOTE: Excessive sound pressure from earphones or headphones can cause hearing damage or loss. Adjustment of the equalizer to maximum increases the earphones and headphones output voltage and therefore the sound pressure level.</p>
<p>13</p>	 <p>USB Type-C downstream port (Data only)</p>	<p>Port with  icon supports 5 V/3 A. Connect your USB device. You can use these ports only after you have connected the USB cable (Type-A to Type-B or Type-C to Type-C) from the computer to the monitor. NOTE: This port is downstream only and unable to broadcast video or sound to the display or speakers.</p>
<p>14</p>	<p>Stand lock</p>	<p>Lock the stand to the monitor using a M3 x 6 mm screw (screw not included).</p>



Monitor specifications

Model	P2424HEB
Screen type	Active matrix - TFT LCD
Panel Type	In-plane switching Technology
Aspect ratio	16:9
Viewable image dimensions	
Diagonal	60.47 cm (23.8 in.)
Active Area	
Horizontal	527.04 mm (20.75 in.)
Vertical	296.46 mm (11.67 in.)
Area	156246.28 mm ² (242.18 in. ²)
Pixel pitch	0.2745 mm x 0.2745 mm
Pixel per inch (PPI)	92.56
Viewing angle	
Horizontal	178° (typical)
Vertical	178° (typical)
Brightness	250 cd/m ² (typical)
Contrast ratio	1000 to 1 (typical)
Display screen coating	Anti-glare treatment of the front polarizer (3H) hard coating
Backlight	LED
Response Time (Gray to Gray)	5 ms (Fast mode) 8 ms (Normal mode)
Color depth	16.78 million colors
Color gamut ¹	99% sRGB
Connectivity	• 1 x DP 1.2 (HDCP 1.4) • 1 x HDMI 1.4 (HDCP 1.4) ²



	<ul style="list-style-type: none"> • 1 x USB Type-B (USB 3.2 Gen1 upstream port) • 1 x USB Type-C (Alternate mode with DisplayPort 1.2, USB 3.2 Gen1 upstream port, Power Delivery PD up to 90 W) • 1 x USB Type-C downstream (15 W), USB 3.2 Gen1 (5 Gbps) • 1 x DP (Out) with MST • 2 x super speed USB 5 Gbps (USB 3.2 Gen1) • 1 x super speed USB 5 Gbps (USB 3.2 Gen1) with BC 1.2 charging capability at 2 A (max) • 1 x 3.5 mm headphone jack • 1 x RJ45
Border width (edge of monitor to active area)	
Top	36.30 mm
Left/Right	5.50 mm
Bottom	17.20 mm
Adjustability	
Height adjustable stand	150 mm
Tilt	-5° to 21°
Swivel	-45° to 45°
Pivot	-90° to 90°
Slant adjust	NA
Cable management	Yes
Dell Display Manager (DDM)Compatibility	Easy Arrange and other key features
Security	Security lock slot (cable lock sold separately)

¹ At panel native only, under Custom Mode preset.

² Supports up to FHD 1920 x 1080 at 60Hz as per specified in HDMI 1.4.



Resolution specifications

Model	P2424HEB
Horizontal scan range	30 kHz to 83 kHz
Vertical scan range	56 Hz to 76 Hz
Default resolution	1920 x 1080 at 60 Hz
Video display capabilities (HDMI & DP & USB Type-C alternate mode)	480p, 560p, 720p, 1080p 1080i (HDMI only)

Preset display modes

Display mode	Horizontal frequency (kHz)	Vertical frequency (Hz)	Pixel clock (MHz)	Sync polarity (Horizontal/Vertical)
VESA, 720 x 400	31.47	70	28.32	-/+
VESA, 640 x 480	31.47	60	25.17	-/-
VESA, 640 x 480	37.50	75	31.5	-/-
VESA, 800 x 600	37.88	60	40	+/+
VESA, 800 x 600	46.88	75	49.5	+/+
VESA, 1024 x 768	48.36	60	65	-/-
VESA, 1024 x 768	60.02	75	78.75	+/+
VESA, 1152 x 864	67.50	75	108	+/+
VESA, 1280 x 1024	64.0	60	108	+/+
VESA, 1280 x 1024	80.0	75	135	+/+
VESA, 1600 x 900	55.99	60	118.25	+/+
VESA, 1920 x 1080	67.50	60	148.50	+/+



DP Multi-Stream Transport (MST) Modes

MST Source Monitor	Maximum number of external monitors that can be supported
	1920 x 1080 at 60 Hz
1920 x 1080 at 60 Hz	3

 **NOTE: Maximum external monitor resolution supported is 1920 x 1080 at 60 Hz only.**

 **NOTE: DP output for MST is supported.**

USB-C Multi-Stream Transport (MST) Modes

MST Source Monitor	Maximum number of external monitors that can be supported
	1920 x 1080 at 60 Hz
1920 x 1080 at 60 Hz	1



Unified Communications (UC) Platform Compatibility List

The table below highlights the call functions that work on the Dell Video Conferencing Monitor – P2424HEB monitor when using the following UC platforms.

Call functions	Button	UC platforms		
		Microsoft Teams	Skype for Business	Zoom
Bring up Microsoft Teams	Teams	Supported	Not supported	Not supported
Answer call	Hookswitch	Supported	Supported	Not supported
End call	Hookswitch	Supported	Supported	Not supported
Reject call	Hookswitch	Supported	Supported	Not supported
Adjust speaker volume down	Volume down	Supported	Supported**	Supported
Adjust speaker volume up	Volume up	Supported	Supported**	Supported
Mute/unmute microphone	Mute	Supported	Supported	Supported*

* Mute function on the Dell P2424HEB monitor works by pressing the Mute button. However, the Mute icon on the UC platform is not synchronized (icon shows unmute).

** Volume function on the Dell P2424HEB monitor does not work on macOS.

 **NOTE: For information about supported operating system, see [Operating system compatibility](#).**



Electrical specifications

Model	P2424HEB
Video input signals	<ul style="list-style-type: none"> • Digital video signal for each differential line Per differential line at 100 ohm impedance • DP/HDMI/USB Type-C signal input support
Input voltage/ frequency/current	100-240 VAC/50 or 60 Hz \pm 3 Hz/2.3 A (maximum)
Inrush current	120 V: 42 A (Max.) 240 V: 80 A (Max.)
Power Consumption	0.3 W (Off Mode) ¹ 0.3 W (Standby Mode) ¹ 0.8 W (Networked standby mode) ¹ 15.5 W (On Mode) ¹ 195 W (Max) ² 15.38 W (P_{on}) ³ 50.46 kWh (TEC) ³

¹As defined in EU 2019/2021 and EU 2019/2013.

²Max brightness and contrast setting with maximum power loading on all USB ports.

³ P_{on} : Power consumption of On Mode as defined in Energy Star 8.0 version.

TEC: Total energy consumption in kWh as defined in Energy star 8.0 version.

This document is informational only and reflects laboratory performance. Your product may perform differently, depending on the software, components and peripherals you ordered and shall have no obligation to update such information. Accordingly, the customer should not rely upon this information in making decisions about electrical tolerances or otherwise. No warranty as to accuracy or completeness is expressed or implied.



NOTE: This monitor is ENERGY STAR certified.



This product qualifies for ENERGY STAR in the factory default settings which can be restored by “Factory Reset” function in the OSD menu. Changing the factory default settings or enabling other features may increase power consumption that could exceed the ENERGY STAR specified limit.



Webcam specifications

Video Resolution & Frame Size	<ul style="list-style-type: none">· 2K (2560 x 1440) @ 30 fps· FHD (1920 x 1080) @ 30 fps or 60 fps· HD (1280 x 720) @ 30 fps or 60 fps
USB Interface	USB 3.0
Field of view	78 degree
Shutter	Manual shutter
Windows Hello	Yes
AI Auto Framing	Yes
Auto focus	Yes
Zoom	4x Digital Zoom
Aperture	f2.0

Speaker specifications

Speaker rated power	2 x 5 W
Frequency Response	100 Hz - 20 kHz
Impedance	8 ohm

Microphone specifications

Microphone type	Digital microphone x 2
-----------------	------------------------

Physical characteristics

Model	P2424HEB
Connector type	<ul style="list-style-type: none">· DP connector (in)· DP connector (out)· HDMI connector· Audio jack· RJ45 connector· USB Type-C upstream connector· USB Type-B upstream connector· USB 3.2 Gen1 downstream connector x 3· USB Type-C downstream connector
Signal cable type	DP to DP 1.8 M cable USB 3.2 Gen1 Type-A to B 1.8 M cable USB 3.2 Gen1 Type-C to C 1.8 M cable



Dimensions	
Height (extended)	551.62 mm (21.70 in.)
Height (compressed)	401.62 mm (15.81 in.)
Width	538.04 mm (21.20 in.)
Depth	185.00 mm (7.30 in.)
Dimensions (without stand)	
Height	374.55 mm (14.75 in.)
Width	538.04 mm (21.20 in.)
Depth	60.53 mm (2.38 in.)
Stand dimensions	
Height (extended)	410.80 mm (16.20 in.)
Height (compressed)	364.00 mm (14.30 in.)
Width	268.00 mm (10.55 in.)
Depth	185.00 mm (7.30 in.)
Weight	
Weight with packaging	8.43 kg (18.58 lb)
Weight with stand assembly and cables	6.46 kg (14.24 lb)
Weight without stand assembly (For wall mount or VESA mount considerations - no cables)	4.44 kg (9.79 lb)
Weight of stand assembly	1.64 kg (3.62 lb)



Environmental characteristics

Compliant Standards	
<ul style="list-style-type: none"> ENERGY STAR certified Monitor. EPEAT registered where applicable. EPEAT registration varies by country. See https://www.epeat.net for registration status by country. TCO Certified & TCO Certified Edge. RoHS Compliant. BFR/PVC Free monitor (excluding external cables). Meets NFPA 99 leakage current requirements. Arsenic-Free glass and Mercury-Free for the panel only. 	
Temperature	
Operating	0°C to 40°C (32°F to 104°F)
Non-operating	-20°C to 60°C (-4°F to 140°F)
Humidity	
Operating	10% to 80% (non-condensing)
Non-operating	5% to 90% (non-condensing)
Altitude	
Operating	5,000 m (16,404 ft) (maximum)
Non-operating	12,192 m (40,000 ft) (maximum)
Thermal dissipation	665.37 BTU/hour (maximum) 52.89 BTU/hour (on mode)

Video bandwidth

Host video port	Video cable	Color depth	Resolution
USB-C (Alt Mode DP 1.2)	USB-C Gen1 cable	8 bits	1920 x 1080 @ 60Hz
USB-C (Alt Mode DP 1.4)	USB-C Gen1 cable	8 bits	1920 x 1080 @ 60Hz
HDMI 1.4	HDMI 2.0 cable	8 bits	1920 x 1080 @ 60Hz
HDMI 2.0		8 bits	1920 x 1080 @ 60Hz
DP 1.2	DP cable	8 bits	1920 x 1080 @ 60Hz
DP 1.4		8 bits	1920 x 1080 @ 60Hz



Audio path

Host video port	USB upstream cable	Audio path
USB-C (Alt Mode DP 1.2)	USB-C Gen1 cable	Echo Cancelling Speakerphone (DELL P2424HEB USB)
		DELL P2424HEB (Display Audio)
USB-C (Alt Mode DP 1.4)	USB-C Gen1 cable	Echo Cancelling Speakerphone (DELL P2424HEB USB)
		DELL P2424HEB (Display Audio)
DP	USB-A to USB-B cable connected	Echo Cancelling Speakerphone (DELL P2424HEB USB)
	DELL P2424HEB (Display Audio)	
HDMI	USB-A to USB-B cable not connected	DELL P2424HEB (Display Audio)
	USB-A to USB-B cable connected	Echo Cancelling Speakerphone (DELL P2424HEB USB)
		DELL P2424HEB (Display Audio)
USB-A to USB-B cable not connected	DELL P2424HEB (Display Audio)	

USB speed bandwidth

Host	USB upstream cable	USB Device connected to USB-A or USB-C downstream port
USB-C (Alt Mode DP 1.2)	USB-C Gen1 cable	supported, USB 2.0/3.2 Gen1
USB-C (Alt Mode DP 1.4)	USB-C Gen1 cable	supported, USB 2.0/3.2 Gen1
USB-A 2.0	USB-A to USB-B cable	supported, USB 2.0
USB-A 3.2 Gen1	USB-A to USB-B cable	supported, USB 2.0/3.2 Gen1
USB-C 3.2 Gen1 (Data only)	USB-C Gen1 cable	supported, USB 2.0/3.2 Gen1
USB-C 3.2 Gen2 (Data only)	USB-C Gen1 cable	supported, USB 2.0/3.2 Gen1



Pin assignments

DP port (in)

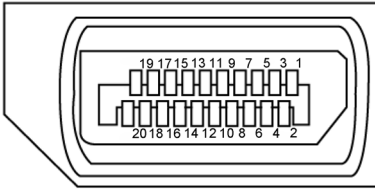

Pin number	20-pin side of the connected signal cable
1	ML3(n)
2	GND
3	ML3(p)
4	ML2(n)
5	GND
6	ML2(p)
7	ML1(n)
8	GND
9	ML1(p)
10	ML0(n)
11	GND
12	ML0(p)
13	CONFIG1
14	CONFIG2
15	AUX CH (p)
16	GND
17	AUX CH (n)
18	Hot Plug Detect
19	Return
20	DP_PWR



DP port (out)

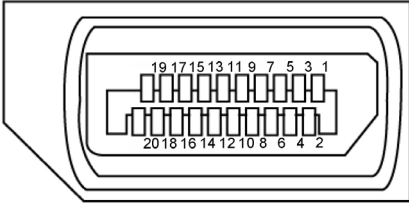

Pin number	20-pin side of the connected signal cable
1	ML0(p)
2	GND
3	ML0(n)
4	ML1(p)
5	GND
6	ML1(n)
7	ML2(p)
8	GND
9	ML2(n)
10	ML3(p)
11	GND
12	ML3(n)
13	CONFIG1
14	CONFIG2
15	AUX CH(p)
16	GND
17	AUX CH(n)
18	Hot Plug Detect
19	Return
20	DP_PWR



HDMI port

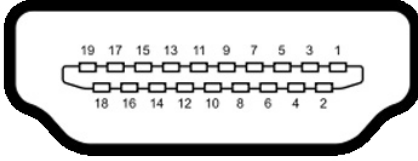

Pin number	19-pin side of the connected signal cable
1	TMDS DATA 2+
2	TMDS DATA 2 SHIELD
3	TMDS DATA 2-
4	TMDS DATA 1+
5	TMDS DATA 1 SHIELD
6	TMDS DATA 1-
7	TMDS DATA 0+
8	TMDS DATA 0 SHIELD
9	TMDS DATA 0-
10	TMDS CLOCK+
11	TMDS CLOCK SHIELD
12	TMDS CLOCK-
13	CEC
14	Reserved (N.C. on device)
15	DDC CLOCK (SCL)
16	DDC DATA (SDA)
17	DDC/CEC Ground
18	+5 V POWER
19	HOT PLUG DETECT



USB Type-C port

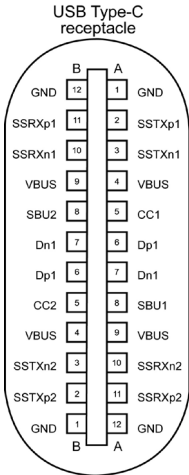

typically connected to a charger through a Type-C cable

Pin	Signal	Pin	Signal
A1	GND	B12	GND
A2	SSTXp1	B11	SSRXp1
A3	SSTXn1	B10	SSRXn1
A4	VBUS	B9	VBUS
A5	CC1	B8	SBU2
A6	Dp1	B7	Dn1
A7	Dn1	B6	Dp1
A8	SBU1	B5	CC2
A9	VBUS	B4	VBUS
A10	SSRXn2	B3	SSTXn2
A11	SSRXp2	B2	SSTXp2
A12	GND	B1	GND





Universal Serial Bus (USB)

This section gives you information about the USB ports available on your monitor.

NOTE: Up to 2 A on USB downstream port (port with  battery icon) with BC 1.2 compliance devices; up to 0.9 A on the other USB downstream ports; Up to 3 A on USB Type-C downstream port (port with  icon) with 5 V/3 A compliance devices.

Your computer has the following USB ports:

- 2 upstream - at rear.
- 4 downstream - 2 at bottom, 2 at rear.

Power Charging Port - the ports with  battery icon supports fast current charging capability if the device is BC 1.2 compatible. The USB Type-C downstream port with  icon supports fast current charging capability if the device is 5 V/3 A compatible.

NOTE: The monitor's USB ports work only when the monitor is on or on in Standby Mode. If the USB cable (Type-C to Type-C) is plugged in, the USB ports work normally. Otherwise, follow the OSD setting of Other USB Charging, if the setting is "On in Standby Mode" then USB work normally, otherwise USB is disabled. If you turn off the monitor and then turn it on, the attached peripherals may take a few seconds to resume normal functionality.

Transfer speed	Data rate	Maximum power consumption (each port)
Super speed	5 Gbps	4.5 W
High speed	480 Mbps	2.5 W
Full speed	12 Mbps	2.5 W

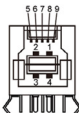
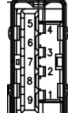
USB upstream port		USB downstream port	
			
Pin number	Signal name	Pin number	Signal name
1	VBUS	1	VBUS
2	D-	2	D-
3	D+	3	D+
4	GND	4	GND
5	StdB_SSTX-	5	StdA_SSRX-
6	StdB_SSTX+	6	StdA_SSRX+
7	GND_DRAIN	7	GND_DRAIN
8	StdB_SSRX-	8	StdA_SSTX-
9	StdB_SSRX+	9	StdA_SSTX+
Shell	Shield	Shell	Shield



RJ45 Port (Connector Side)

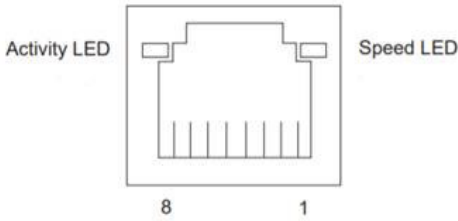

Pin No.	10BASE-T 100BASE-T	1000BASE-T
1	Transmit+	BI_DA+
2	Transmit-	BI_DA-
3	Receive+	BI_DB+
4	Unused	BI_DC+
5	Unused	BI_DC-
6	Receive-	BI_DB-
7	Unused	BI_DD+
8	Unused	BI_DD-

Driver installation

Install the Realtek USB GBE Ethernet Controller Driver available for your system. This is available for download at <https://www.dell.com/support> under the “Driver and download” section.

Network (RJ45) data rate via USB-C max speed is 1000 Mbps.

Wake-on-LAN behavior

Computer power save state	System behavior after receiving Wake-on-LAN (WOL) command
Modern Standby (S0ix)	Computer and Monitor remain in Standby but network communication is enabled.
Standby/Sleep (S3)	Both Computer and Monitor are turned ON.
Hibernate (S4)	Both Computer and Monitor are turned ON.
OFF/Shutdown (S5)	Both Computer and Monitor are turned ON.



 **NOTE: The computer BIOS must be configured to enable WOL function first.**

 **NOTE: This LAN port is 1000Base-T IEEE 802.3az compliant, supporting Mac Address (Printed on model label) Pass-thru (MAPT), Wake-on-LAN (WOL) from standby mode (S3 only) and UEFI* PXE Boot function [UEFI PXE Boot is not supported on Dell Desktop PC's (except for OptiPlex 7090/3090 Ultra Desktop)], these 3 features depend on BIOS settings and version of the OS. Functionality may vary with Non Dell PC's.**

*UEFI stands for Unified Extensible Firmware Interface.

 **NOTE: WOL S4 and WOL S5 only capable with Dell Systems that support DPBS and is with USB-C connection only. Ensure DPBS function are enabled on both the Computer and Monitor.**

 **NOTE: Any issue related to WOL, users should debug the computer without monitor. After the problem is solved, then connect to the Monitor.**



RJ45 Connector LED status:

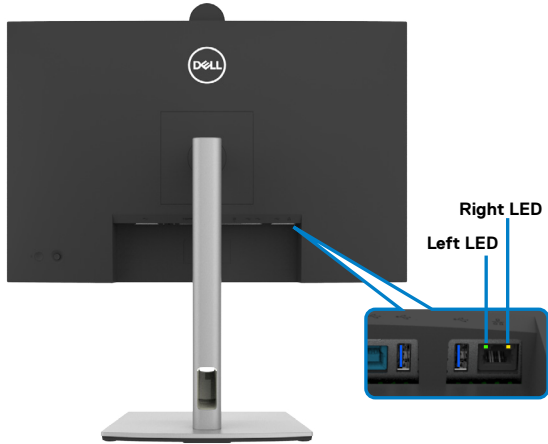

LED	Color	Description
Right LED	Amber or Green	Speed indicator: <ul style="list-style-type: none">• Amber On - 1000 Mbps• Green On - 100 Mbps• Off - 10 Mbps
Left LED	Green	Link/Activity indicator: <ul style="list-style-type: none">• Blinking - Activity on the port.• Green On - Link is being established.• Off - Link is not established.

 **NOTE:** RJ45 cable is not the standard in-box accessory.



Plug-and-Play capability

You can connect the monitor to any Plug and Play-compatible system. The monitor automatically provides the computer with its Extended Display Identification Data (EDID) using Display Data Channel (DDC) protocols so that the computer can configure itself and optimize the monitor settings. Most monitor installations are automatic; you can select different settings as required. For more information about changing the monitor settings, see [Operating the Monitor](#).

LCD monitor quality and pixel policy

During the LCD Monitor manufacturing process, it is not uncommon for one or more pixels to become fixed in an unchanging state which are hard to see and do not affect the display quality or usability. For more information on Dell Monitor Quality and Pixel Policy, see <https://www.dell.com/pixelguidelines>.



Ergonomics

△ CAUTION: Improper or prolonged usage of keyboard may result in injury.

△ CAUTION: Viewing the monitor screen for extended periods of time may result in eye strain.

For comfort and efficiency, observe the following guidelines when setting up and using your computer workstation:

- Position your computer so that the monitor and keyboard are directly in front of you as you work. Special shelves are commercially available to help you correctly position your keyboard.
- To reduce the risk of eye strain and neck/arm/back/shoulder pain from using the monitor for long periods of time, we suggest you to:
 1. Set the distance of the screen between 20 to 28 in. (50 - 70 cm) from your eyes.
 2. Blink frequently to moisten your eyes or wet your eyes with water after prolonged usage of the monitor.
 3. Take regular and frequent breaks for 20 minutes every two hours.
 4. Look away from your monitor and gaze at a distant object at 20 feet away for at least 20 seconds during the breaks.
 5. Perform stretches to relieve tension in the neck, arm, back, and shoulders during the breaks.
- Make sure that the monitor screen is at eye level or slightly lower when you are sitting in front of the monitor.
- Adjust the tilt of the monitor, its contrast, and brightness settings.
- Adjust the ambient lighting around you (such as overhead lights, desk lamps, and the curtains or blinds on nearby windows) to minimize reflections and glare on the monitor screen.
- Use a chair that provides good lower-back support.
- Keep your forearms horizontal with your wrists in a neutral, comfortable position while using the keyboard or mouse.
- Always leave space to rest your hands while using the keyboard or mouse.
- Let your upper arms rest naturally on both sides.
- Ensure that your feet are resting flat on the floor.
- When sitting, make sure that the weight of your legs is on your feet and not on the front portion of your seat. Adjust your chair's height or use a footrest if necessary to maintain a proper posture.
- Vary your work activities. Try to organize your work so that you do not have to sit and work for extended periods of time. Try to stand or get up and walk around at regular intervals.



- Keep the area under your desk clear of obstructions and cables or power cords that may interfere with comfortable seating or present a potential trip hazard.

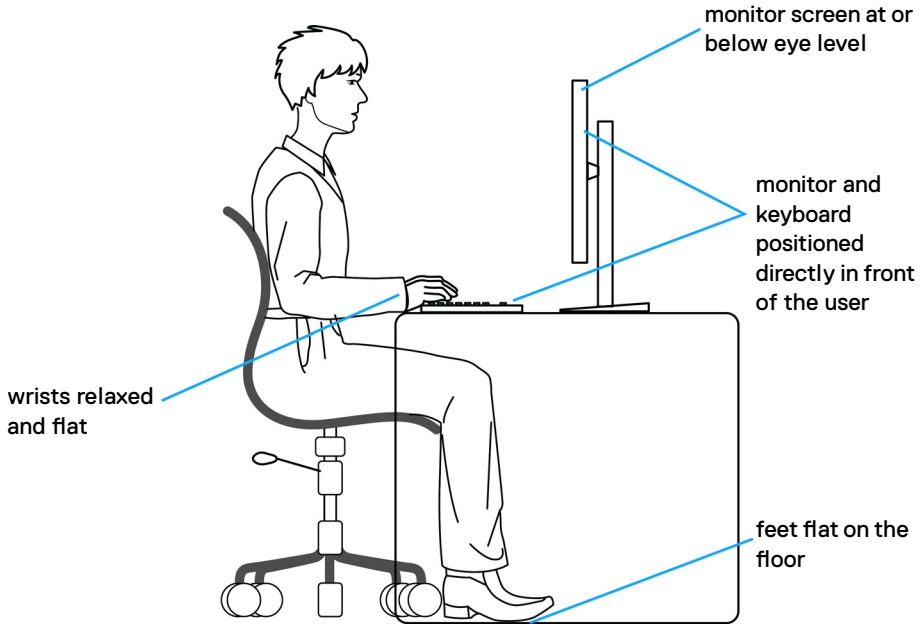

Handling and moving your display

To ensure the monitor is handled safely when lifting or moving it, follow the guidelines mentioned below:

- Before moving or lifting the monitor, turn off your computer and the monitor.
- Disconnect all cables from the monitor.
- Place the monitor in the original box with the original packing materials.
- Hold the bottom edge and the side of the monitor firmly without applying excessive pressure when lifting or moving the monitor.

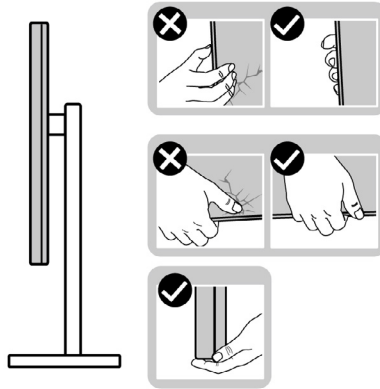

- When lifting or moving the monitor, ensure the screen is facing away from you and do not press on the display area to avoid any scratches or damage.

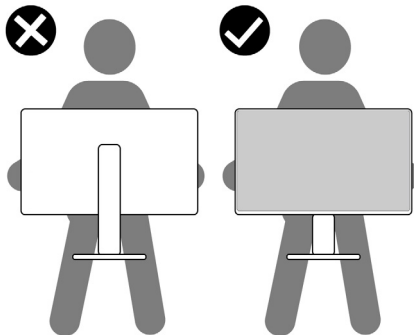

- When transporting the monitor, avoid any sudden shock or vibration to it.



- When lifting or moving the monitor, do not turn the monitor upside down while holding the stand base or stand riser. This may result in accidental damage to the monitor or cause personal injury.

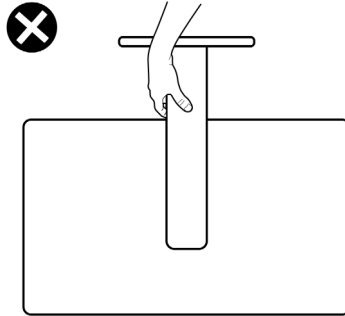

Maintenance guidelines

Cleaning your monitor

⚠ CAUTION: Read and follow the [Safety instructions](#) before cleaning the monitor.

⚠ WARNING: Before cleaning the monitor, unplug the monitor power cable from the electrical outlet.

For best practices, follow the instructions in the list below when unpacking, cleaning, or handling your monitor:

- Use a clean cloth that is slightly dampened with water to clean the stand assembly, the screen, and the chassis of your Dell monitor. If available, use a screen-cleaning tissue or solution suitable for cleaning Dell monitors.
- After cleaning the surface of the table, ensure that it is thoroughly dry and free from any moisture or cleaning agent before placing your Dell monitor on it.

⚠ CAUTION: Do not use detergents or other chemicals such as benzene, thinner, ammonia, abrasive cleaners, alcohol or compressed air.

⚠ CAUTION: Using chemicals for cleaning may cause changes in the appearance of the monitor, such as color fading, milky film on the monitor, deformation, uneven dark shade, and peeling of screen area.

⚠ WARNING: Do not spray the cleaning solution or even water directly on the surface of the monitor. Doing so will allow liquids to accumulate at the bottom of the display panel and corrode the electronics resulting in permanent damage. Instead, apply the cleaning solution or water to a soft cloth and then clean the monitor.





 **NOTE: Monitor damages due to improper cleaning methods and the use of benzene, thinner, ammonia, abrasive cleaners, alcohol, compressed air, detergent of any kind will lead to a Customer Induced Damage (CID). CID is not covered under the standard Dell warranty.**

- If you notice white residual powder when you unpack your monitor, wipe it off with a cloth.
- Handle your monitor with care as a darker-colored monitor may get scratched and show white scuff marks more than a lighter-colored monitor.
- To help maintain the best image quality on your monitor, use a dynamically changing screen saver and turn off your monitor when not in use.



Setting up the monitor

Attaching the stand

-  **NOTE:** The stand is not installed at the factory when shipped.
-  **NOTE:** The following instructions are applicable only for the stand that was shipped with your monitor. If you are attaching a stand that you purchased from any other source, follow the setup instructions that were included with the stand.

To attach the monitor stand:

1. Open the front flap of the box to get the stand riser and stand base.

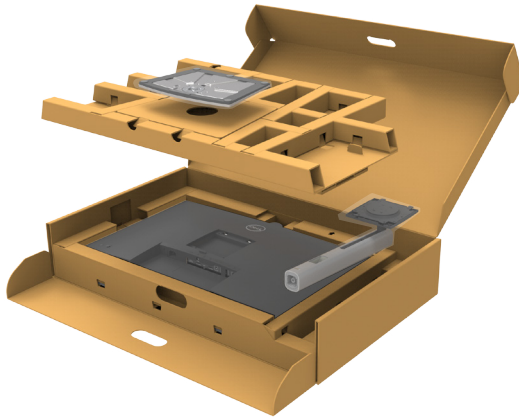

2. Align and place the stand riser on the stand base.
3. Open the screw handle at the bottom of the stand base and turn it clockwise to secure the stand assembly.



4. Close the screw handle.

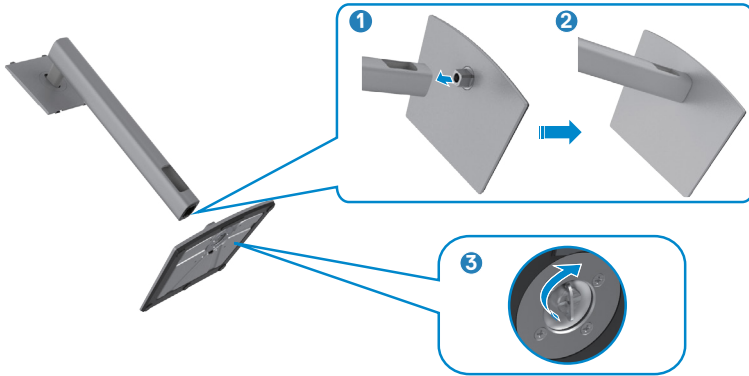

5. Open the protective cover on the monitor to access the VESA slot on the monitor.



6. Slide the tabs on the stand riser into the slots on the display back cover and lower the stand assembly to snap it into place.



7. Hold the stand riser and lift the monitor carefully, then place it on a flat surface.



NOTE: Hold the stand riser firmly when lifting the monitor to avoid any accidental damage.

8. Lift the protective cover from the monitor.

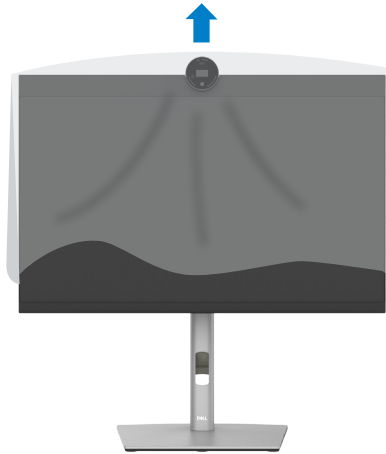

Using the tilt, swivel, and vertical extension

NOTE: The following instructions are applicable only for the stand that was shipped with your monitor. If you are connecting a stand that you purchased from any other source, follow the set up instructions that were included with the stand.

Tilt, swivel and vertical extension

With the stand attached to the monitor, you can tilt the monitor for the most comfortable viewing angle.

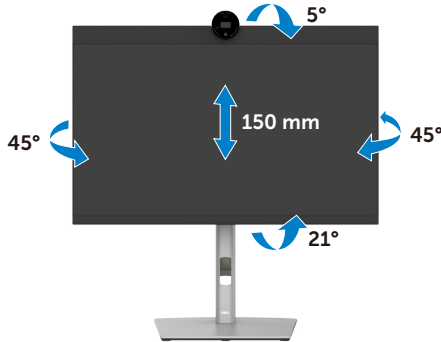

NOTE: The stand is detached when the monitor is shipped from the factory.



Rotating the Display

Before you rotate the display, extend the display vertically until the top of the stand riser and then tilt the display backwards until the maximum to avoid hitting the bottom edge of the display.



NOTE: To toggle the display setting on your Dell computer between landscape and portrait when rotating the display, download and install the latest graphics driver. To download, go to <https://www.dell.com/support/drivers> and search for the appropriate driver.

NOTE: When the display is in portrait mode, you may experience performance degradation when using graphic-intensive applications such as 3D gaming.



Configuring the display settings on your computer after rotation

After you have rotated the display, complete the procedure given below to configure the display settings on your computer.

 **NOTE: If you are using the monitor with a non-Dell computer, go to the graphics card manufacturer’s website or your computer manufacturer website for information on how to rotate the contents of your display.**

To configure the Display Settings:

1. Right-click on the **Desktop** and click **Properties**.
2. Select the **Settings** tab and click **Advanced**.
3. If you have an AMD graphics card, select the **Rotation** tab and set the preferred rotation.
4. If you have an **nVidia** graphics card, click the **nVidia** tab, in the left-hand column select **NVRotate**, and then select the preferred rotation.
5. If you have an Intel® graphics card, select the Intel graphics tab, click **Graphic Properties**, select the **Rotation** tab, and then set the preferred rotation.

 **NOTE: If you do not see the rotation option or it is not working correctly, go to <https://www.dell.com/support> and download the latest driver for your graphics card.**

Camera Image Rotation

	Windows 10	Windows 11
Microsoft Teams	×	×
Zoom	√	√

√ Supports camera image rotation.

× Don't support camera image rotation.



Connecting your monitor

⚠ WARNING: Before you begin any of the procedures in this section, follow the [Safety Instructions](#).

📎 NOTE: Dell monitors are designed to work optimally with the Dell supplied cables inside the box. Dell does not guarantee the video quality and performance if non-Dell cables are used.

📎 NOTE: Route the cables through the cable-management slot before connecting them.

📎 NOTE: Do not connect all the cables to the computer at the same time.

📎 NOTE: The images are for the purpose of illustration only. The appearance of the computer may vary.

To connect your monitor to the computer:

1. Turn off your computer.
2. Connect the DisplayPort or USB cable, and the USB Type-C cable from your monitor to the computer.
3. Turn on your monitor.
4. Select the correct input source from the OSD Menu on your monitor and then turn on your computer.

📎 NOTE: P2424HEB default setting is DisplayPort 1.2. A DisplayPort 1.1 Graphic card may not display normally. Please refer to [product specific problems – No image when using DP connection to the PC to change default setting](#).

Connecting the HDMI cable (Optional)

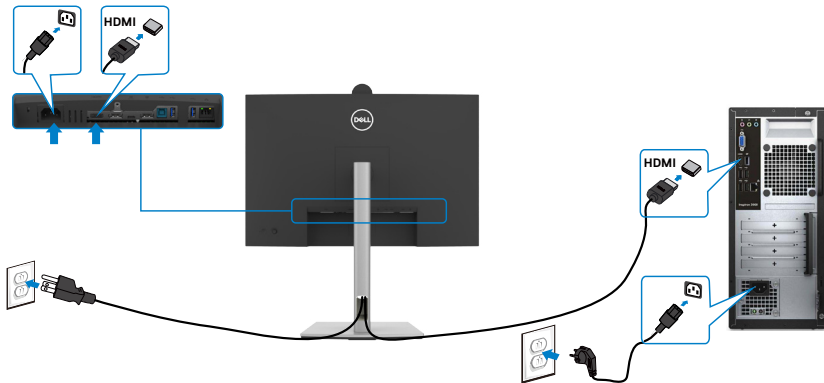

Connecting the DP cable

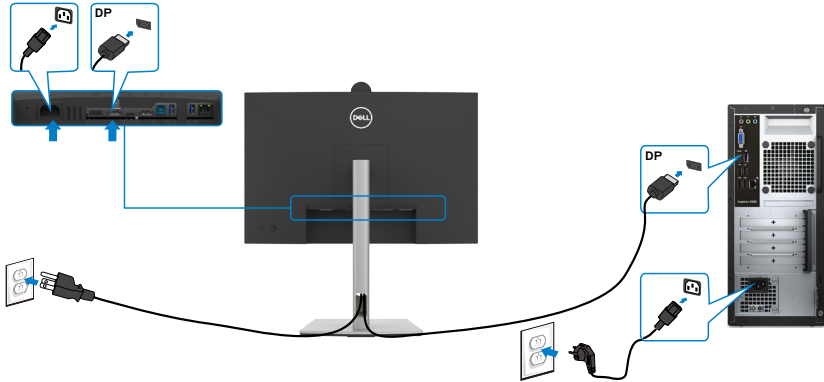

Connecting the monitor for DP Multi-Stream Transport (MST) function

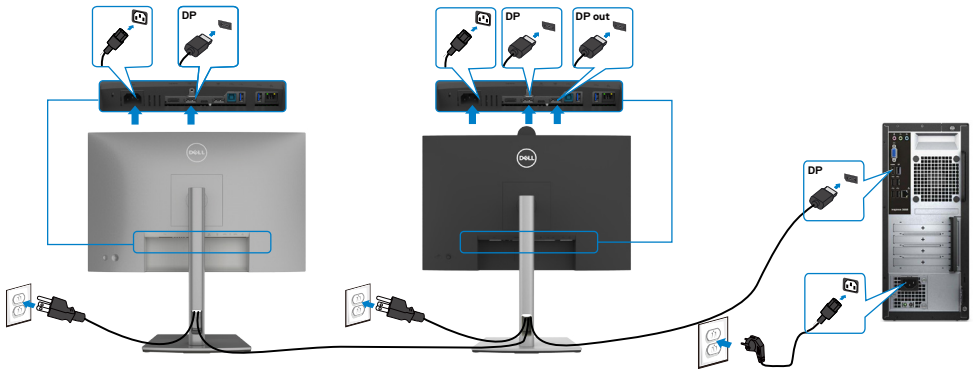

NOTE: Supports the DP MST feature. To make use of this feature, your PC Graphics Card must be certified to at least DP1.2 with MST option.

NOTE: Remove the rubber plug when using DP out connector.



Connecting the USB cable

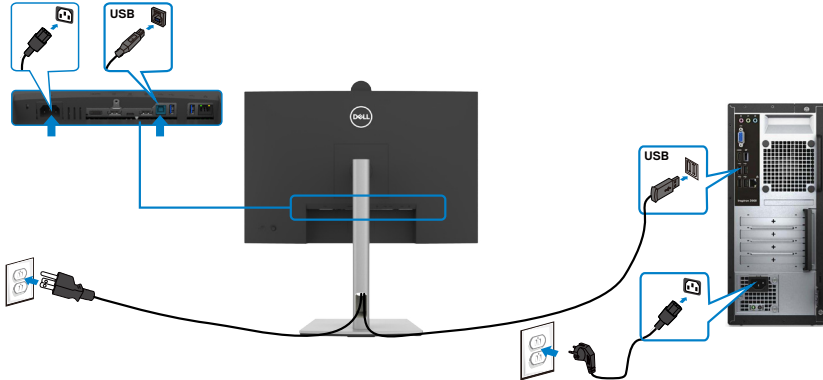

Connecting the USB-C Cable (A to C) (Optional)

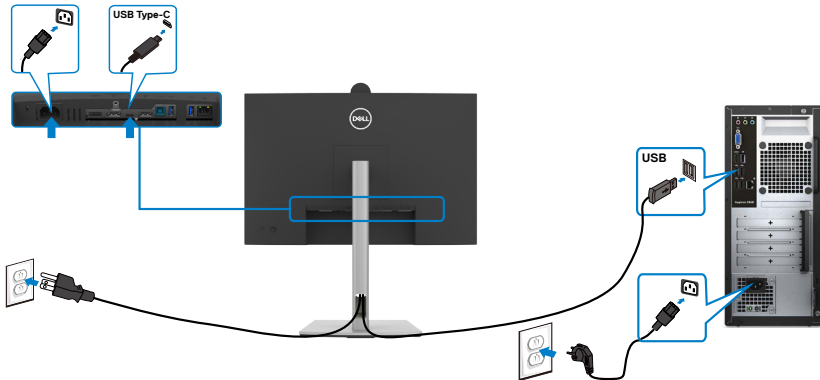

NOTE: This connection only data is available and no video. Need another video connection for display.

NOTE: USB Type-A to Type-C cable is not the standard in-box accessory.



Connecting the USB Type-C cable (C to C)

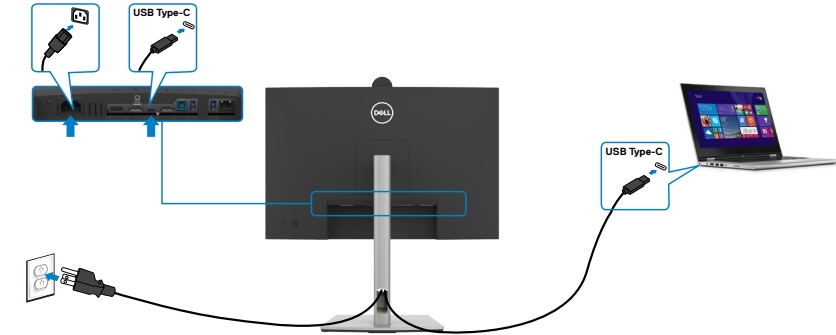

The USB Type-C port on your monitor:

- Can be used as USB Type-C, DisplayPort 1.2 alternatively.
- Supports USB Power Delivery (PD), with profiles up to 90 W.

NOTE: Regardless of the power requirement/actual power consumption of your laptop, or the remaining power runtime in your battery, the Dell monitor is designed to supply power delivery of up to 90 W to your laptop.

Rated power (on laptops that have USB Type-C with Power Delivery)	Maximum charging power
45 W	45 W
65 W	65 W
90 W	90 W
130 W	Not supported



Connecting the monitor for USB-C Multi-Stream Transport (MST) function

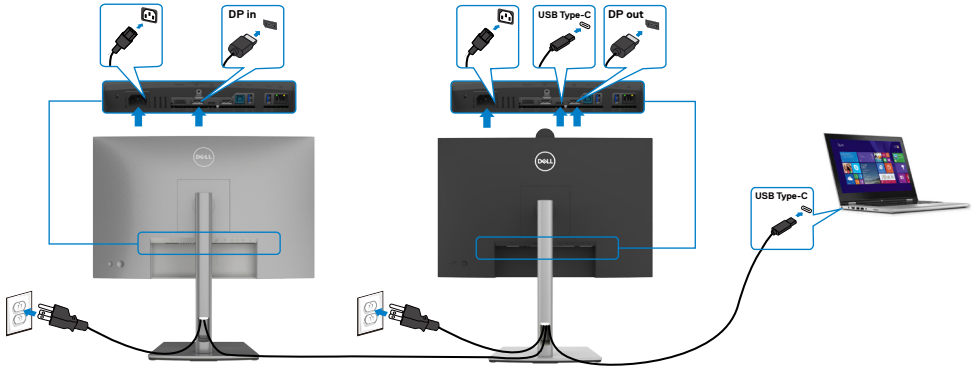

NOTE: The maximum number of supported P2424HEB via MST is subjected to the bandwidth of the USB-C source. Please refer to [product specific problems –No image when using USB Type-C MST](#).

NOTE: Remove the rubber plug when using DP out connector.

Connecting the monitor for RJ45 Cable (Optional)

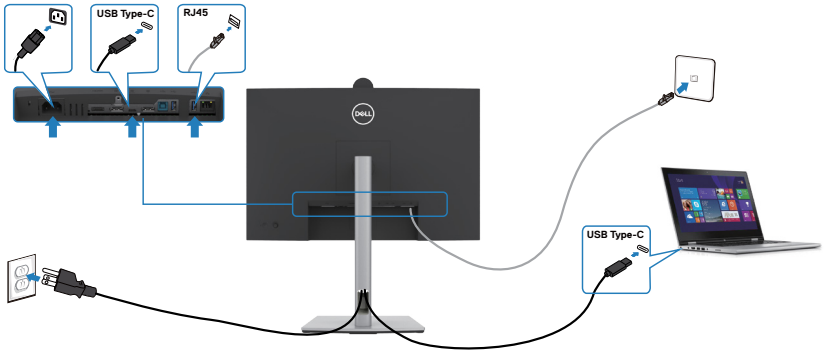

Dell Power Button Sync (DPBS)

The monitor is designed with Dell Power Button Sync (DPBS) feature to allow you to control PC system power state from the monitor power button. This feature is compatible with Dell platforms that support DPBS, and is only supported over USB-C interface.

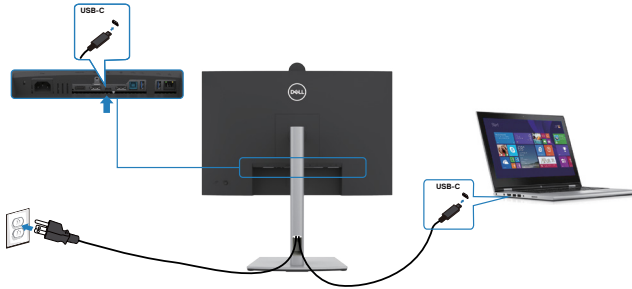

To make sure the DPBS function works for the first time, you should do the following steps for Dell platforms that support DPBS in the **Control Panel** first.

NOTE: DPBS only supports the port with  icon.

NOTE: DPBS is defaulted to OFF, to enable please navigate to Dell Power Button Sync sub menu under Display in OSD.

1. Go to Control Panel.

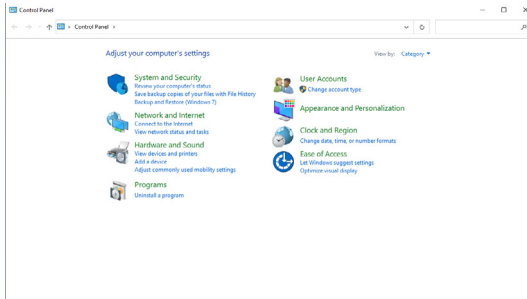

2. Select **Hardware and Sound**, followed by **Power Options**.

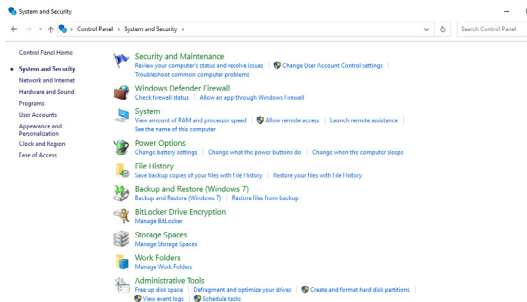

3. Go to System Settings

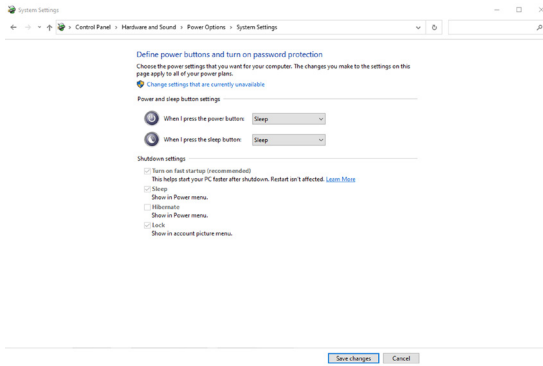

4. In the drop-down menu of **When I press the power button**, there are a few options for selection namely **Do nothing/Sleep/Hibernate/Shut down**, and you can select **Sleep/Hibernate/Shut down**.

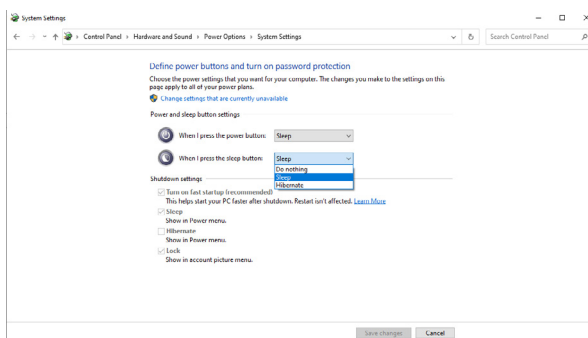
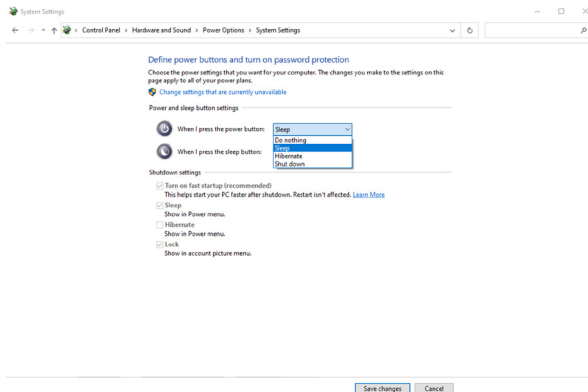

NOTE: Do not select Do nothing, otherwise monitor power button cannot sync with PC system power state.



Connecting the monitor for DPBS for the first time

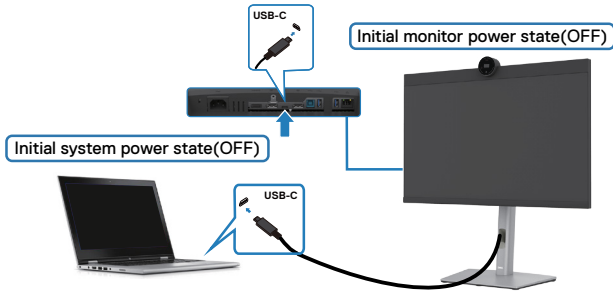

For the first time setting up the DPBS function, please follow below steps:

1. Navigate to Dell Power Button Sync in sub menu under Display and enable it.
2. Ensure both the PC and monitor is OFF.
3. Connect the USB-C cable from the PC to the monitor.
4. Press the monitor power button to turn ON the monitor.
5. Both the monitor and PC will turn ON momentarily. Wait for a while (approximately 6 seconds) and both the PC and monitor will turn OFF.
6. Press either the monitor power button or PC power button, both the PC and monitor will turn ON. The PC system power state is in sync with the monitor power button.

NOTE: When the monitor and PC are both at power OFF state at first time, it is recommended that you turn ON the monitor first, then connect the USB-C cable from the PC to the monitor.

NOTE: You can power the Dell PC* platform using its DC adaptor jack. Alternatively, you can power the Dell PC* platform using the monitor's USB-C cable via Power Delivery (PD); please set USB-C Charging  90 W to On in Off Mode.

* Ensure to check the Dell PC for DPBS supportability.



Using DPBS function

Waking on the USB-C cable

When you connect the USB-C cable, the Monitor/PC state is as follows:

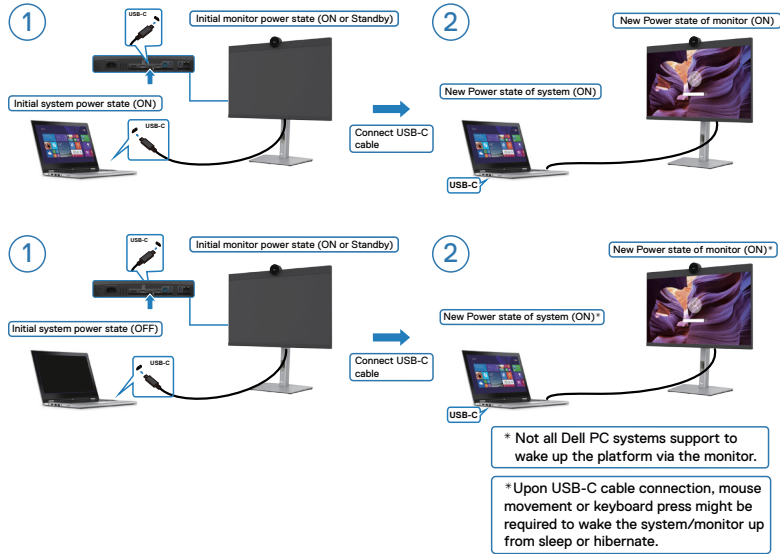

When you press the monitor power button or PC power button, the Monitor/PC state is as follows:

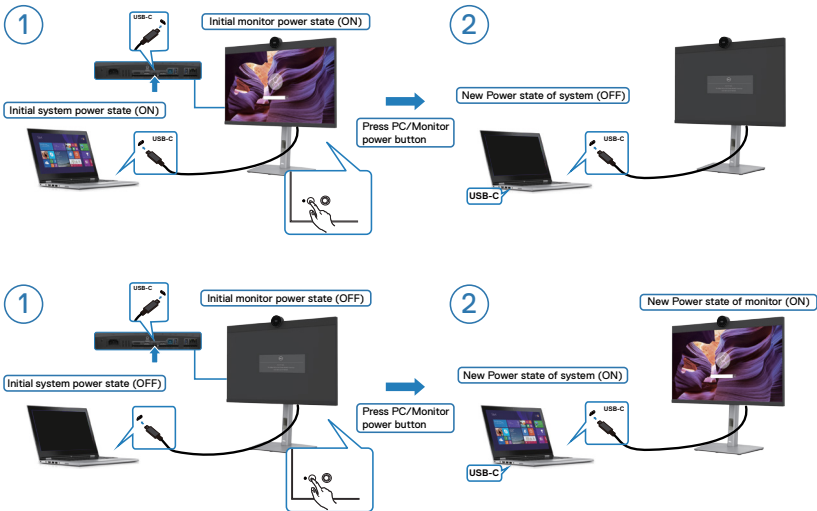

When the monitor and PC power state are both ON, while you **press and hold 4 seconds on monitor power button**, the screen prompt will ask if you would like to shut down the PC.

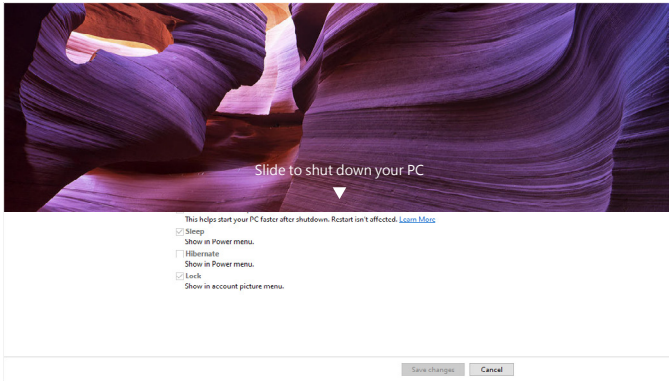
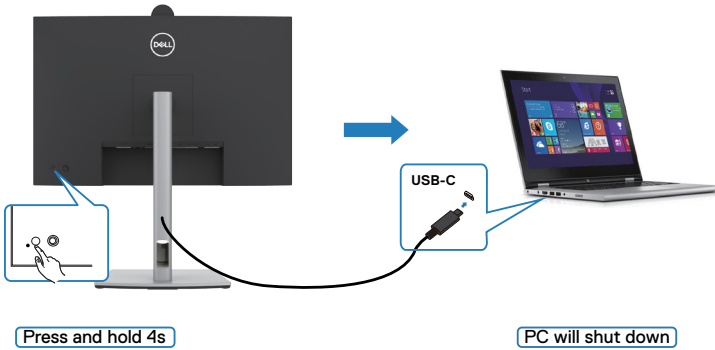

When the monitor and PC power state are both ON, while **you press and hold 10 seconds on monitor power button**, the PC will shut down.

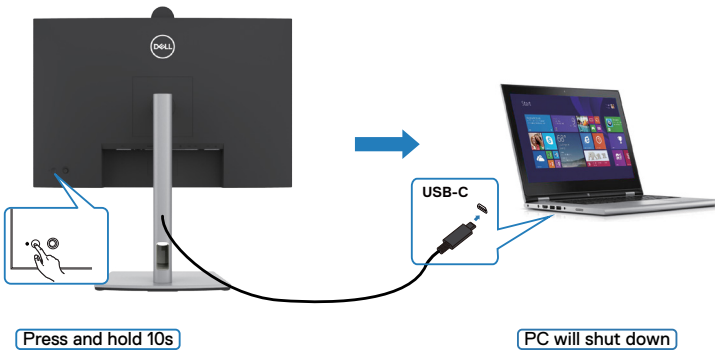

Connecting the monitor for USB-C Multi-Stream Transport (MST) function in DPBS mode

A PC is connected to two monitors in an initially OFF power state, and the PC system power state is in sync with Monitor 1 power button. When you press the Monitor 1 or PC power button, both the Monitor 1 and PC turns ON. Meanwhile the Monitor 2 will remain OFF. You need to manually press the power button on Monitor 2 to turn it ON.

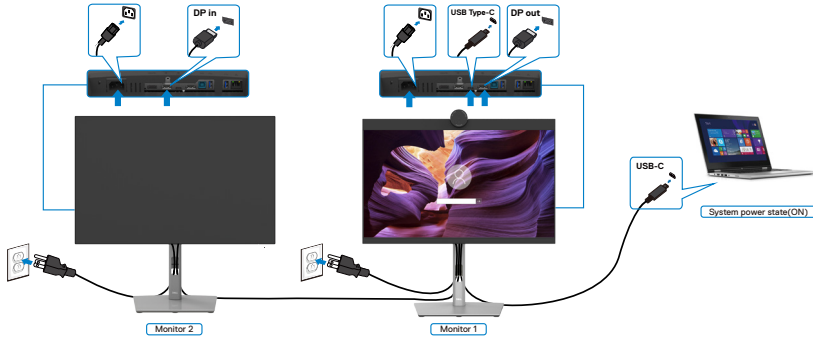

Similarly, a PC is connected to two monitors in an initially ON power state, and the PC system power state is in sync with Monitor 1 power button. When you press the Monitor 1 or PC power button, both the Monitor 1 and PC turns OFF. Meanwhile the Monitor 2 will be in Standby mode. You need to manually press the power button on Monitor 2 to turn it OFF.

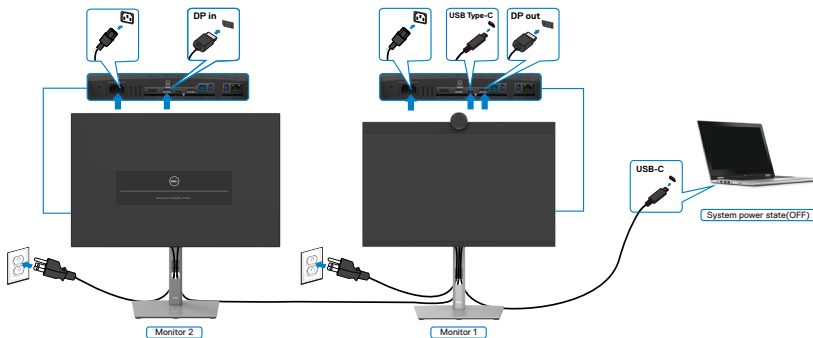

Connecting the monitor for USB-C in DPBS mode

Dell PC* platform has two USB-C ports, so both Monitor 1 and Monitor 2 power state can sync with the PC.

While the PC and two monitors are in an initially ON power state, by pressing the power button on Monitor 1 or Monitor 2 will turn OFF the PC, Monitor 1, and Monitor 2.

* Ensure to check the Dell PC for DPBS supportability.

NOTE: DPBS only supports the port with  icon.

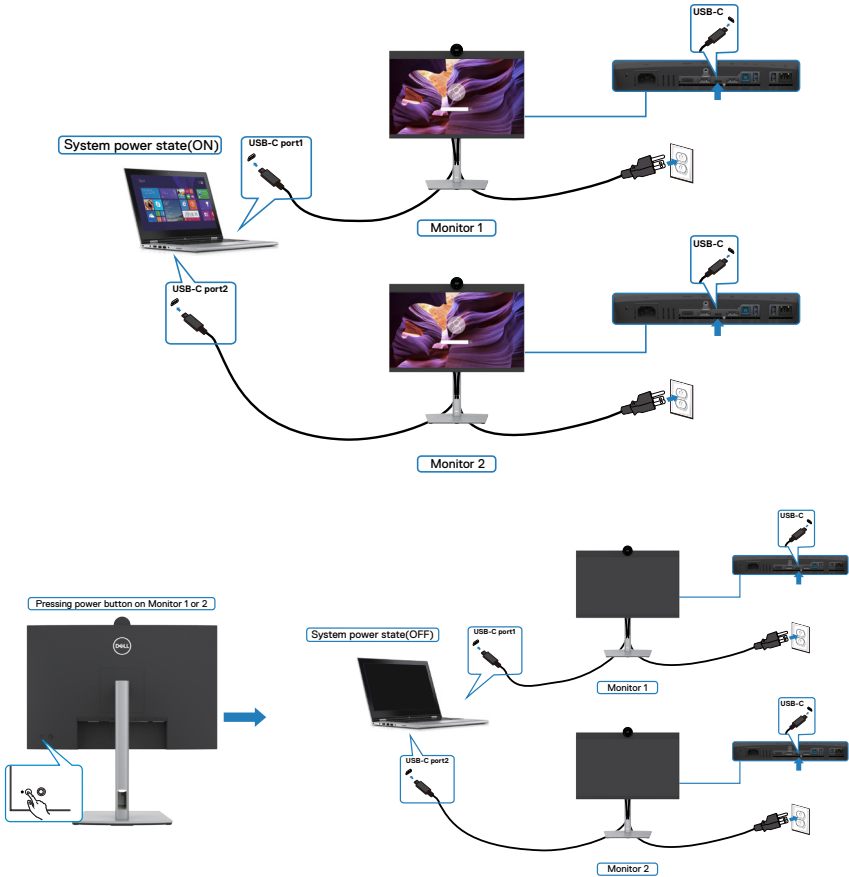

Ensure to set **USB-C Charging 90 W** to **On in Off Mode**. While the PC and two monitors are in an initially OFF power state, by pressing the power button on Monitor 1 or Monitor 2 will turn ON the PC, Monitor1, and Monitor 2.

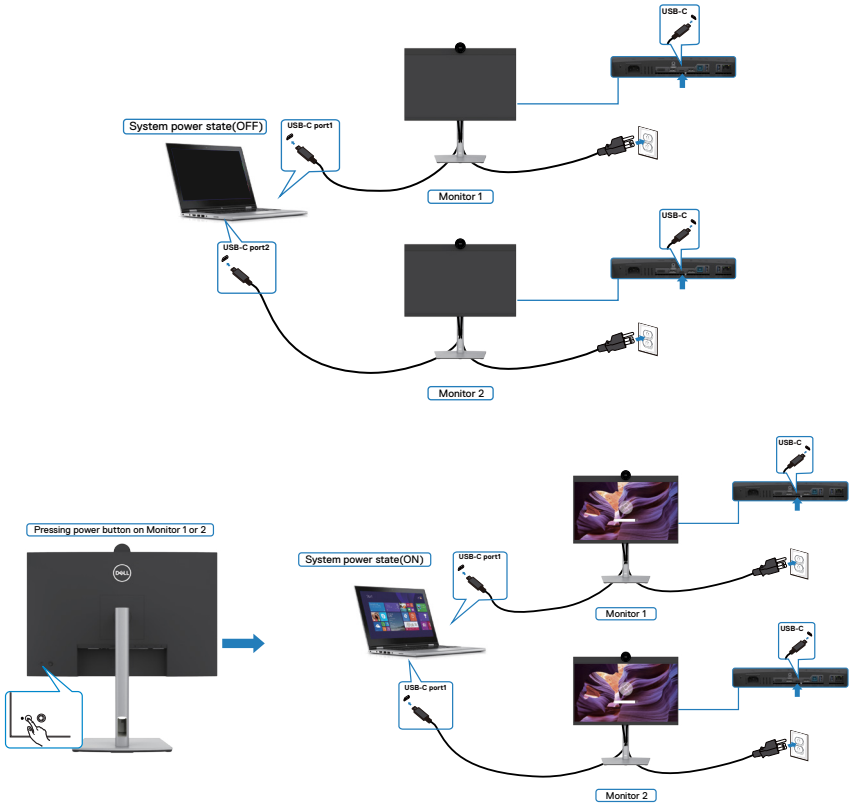

Organizing your cables



After attaching all necessary cables to your monitor and computer, (see [Connecting Your Monitor](#) for cable attachment) organize all cables as shown above.

If your cable is not able to reach your PC, you may connect directly to the PC without routing through the slot on the monitor stand.



Operating the monitor webcam

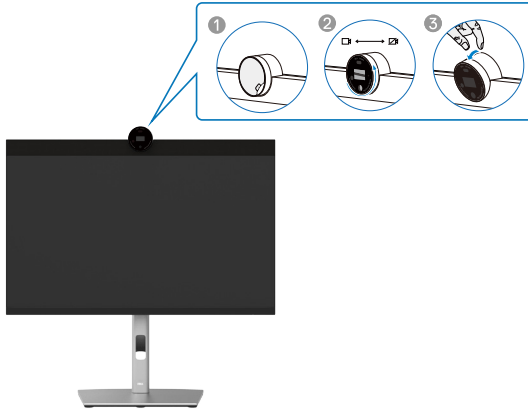

The webcam which offers the following:

- Camera offer 0-20 degree tilt adjustability
- 2K video at 30 fps and Full HD video at 60 fps
- AI Auto-framing
- 4x digital zoom
- Adjustable field-of-view with autofocus
- High Dynamic Range (HDR) and video noise reduction support
- Walk Away Lock and Wake on Approach support
- Windows Hello support
- Additional customization using Dell Peripheral Manager

Auto-framing (Single user framing) :

- If the user is within 2 meters of the webcam, the webcam will enable the Auto-framing.
- (single user framing) feature and adjust the frame to focus on the user. You can enable Autoframing to ensure the camera always keeps you in the center of the frame.

HDR and Video Noise Reduction :

- The webcam's Digital Overlap HDR guarantees superior picture quality in extreme lighting environments, while video noise reduction automatically eliminates grainy images in low light.



Dell Peripheral Manager

What is Dell Peripheral Manager?

The Dell Peripheral Manager application helps you manage and set up various Dell Peripherals connected to your computer. It allows the user to make changes to webcam settings of the device and provides additional customization.

For more details on the application and the customizations available for the Dell P2424HEB, find the User's Guide for Dell Peripheral Manager at

<https://www.dell.com/support>.

Securing your monitor using Kensington lock (optional)

The security lock slot is located at the bottom of the monitor. (See [Security lock slot](#)). Secure your monitor to a table using the Kensington security lock.

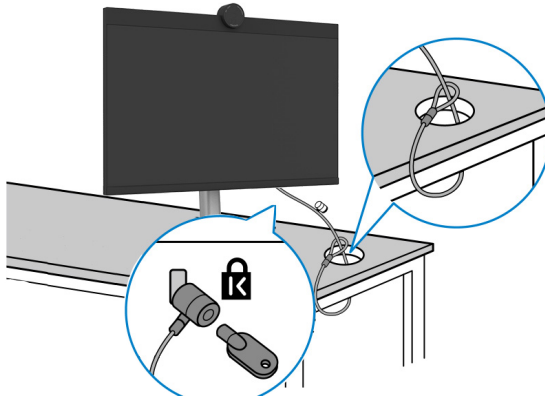

For more information on using the Kensington lock (purchased separately), see the documentation that is shipped with the lock.



NOTE: The image is for the purpose of illustration only. Appearance of the lock may vary.



Removing the monitor stand

-  **NOTE:** To prevent scratches on the LCD screen when removing the stand, ensure that the monitor is placed on a soft surface and handle it carefully.
-  **NOTE:** The following steps are specifically for removing the stand that is shipped with your monitor. If you are removing a stand that you purchased from any other source, follow the setup instructions that are included with the stand.

To remove the stand:

-  **CAUTION:** Place the monitor screen on the desktop. Take note that the webcam is slightly protruded out of the monitor screen, please protect the webcam surface to prevent wear by the desktop.

1. Place the monitor on a soft cloth or cushion.
2. Press and hold the stand-release button.
3. Lift the stand up and away from the monitor.

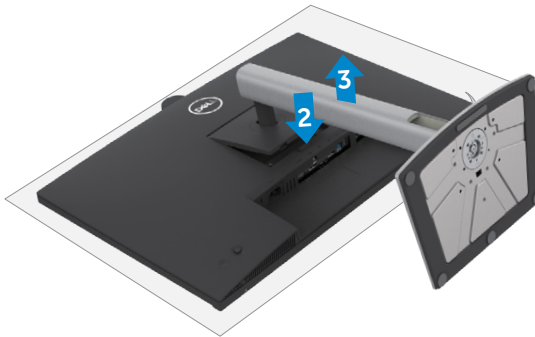

Wall mounting (Optional)



 **NOTE: Use M4 x 10 mm screws to connect the monitor to the wall-mounting kit.**

Refer to the instructions that come with the VESA-compatible wall mounting kit.

1. Place the monitor on a soft cloth or cushion on a stable flat table.
2. Remove the stand. For more information, see [Removing the monitor stand](#).
3. Use a Phillips crosshead screwdriver to remove the four screws securing the plastic cover.
4. Attach the mounting bracket from the wall mounting kit to the monitor.
5. Mount the monitor on the wall. For more information, see the documentation that is shipped with the wall mounting kit.

 **NOTE: For use only with UL or CSA or GS-listed wall mount bracket with minimum weight/load bearing capacity of 17.76 kg (39.15 lb).**



Operating the monitor

Power on the monitor

Press the  button to turn on the monitor.

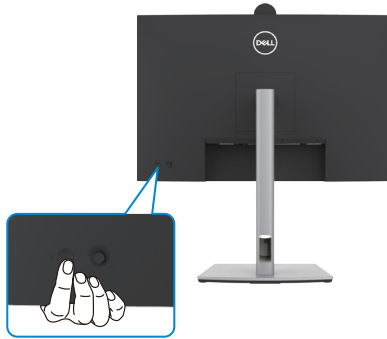

Using the joystick control

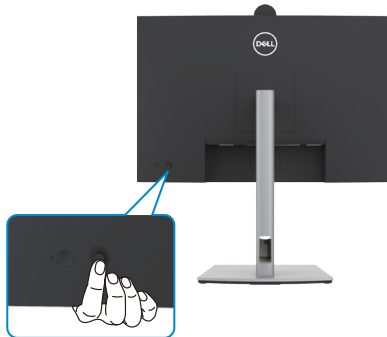



To modify the OSD adjustments using the joystick control on the rear end of the monitor, do the following:

1. Press the joystick to open the OSD Menu Launcher.
2. Move the joystick up/down/center/left/right to toggle between the OSD menu options.



Joystick Functions

Joystick	Description
	Press joystick to open the OSD Menu Launcher.
	For right and left navigation.
	For up and down navigation.

Using the rear-panel controls

Press the Joystick to open the OSD Menu Launcher.

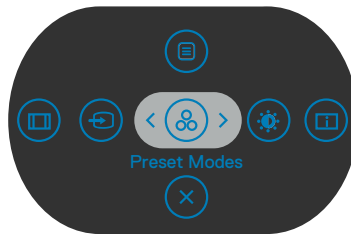







Menu Launcher

- Toggle the Joystick **Up** to open the **Main Menu**.
- Toggle the Joystick **Left** or **Right** to select the desired **Shortcut Keys**.
- Toggle the Joystick **Down** to **Exit**.



Menu Launcher Details

The following table describes the Menu Launcher icons:





Options	Description
 Shortcut key: Menu	Use this Menu button to launch the on-screen display (OSD) and select the OSD menu.
 Shortcut key: Preset Modes	Use this button to choose from a list of preset color modes .
 Shortcut key: Brightness/Contrast	To directly access the Brightness/Contrast adjustment sliders.
 Shortcut key: Display Info	Use this button to choose from a list of Display Info .
 Shortcut key: Aspect Ratio	Use this button to choose from a list of Aspect Ratio .
 Shortcut key: Input Source	Use this button to choose from a list of Input Source .
 Exit	Use this button to go back to the main menu or exit the OSD main menu.

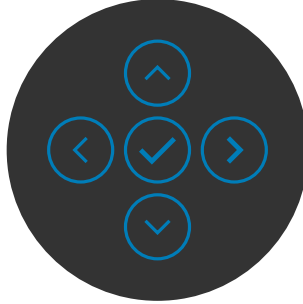

Front-panel button



Use the buttons on the front of the monitor to adjust the image settings.



Front Panel	Description
<p>1</p>   <p>Up Down</p>	Use the Up (increase) and Down (decrease) buttons to adjust items in the OSD menu.
<p>2</p>  <p>Previous</p>	Use the Previous button to go back to the previous menu.
<p>3</p>  <p>Next</p>	Use the Next button to confirm your selection.
<p>4</p>  <p>Tick</p>	Use the Tick button to confirm your selection.

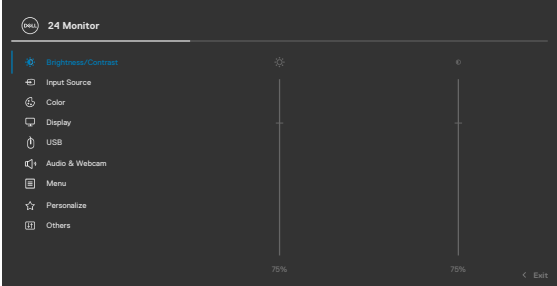

Using the Main Menu

Icon	Menu and Submenus	Description
	Brightness/Contrast	Use this menu to activate Brightness/Contrast adjustment.
		 
	Brightness	Adjusts the luminance of the backlight (Range: 0 - 100). Move the Joystick Up to increase brightness. Move the Joystick Down to decrease brightness.
	Contrast	Adjust the Brightness first, and then adjust Contrast only if further adjustment is necessary. Move the Joystick Up to increase contrast and Move the Joystick Down to decrease contrast (Range: 0 - 100). The Contrast function adjusts the degree of difference between darkness and lightness on the monitor screen.







Icon	Menu and Submenus	Description
------	-------------------	-------------

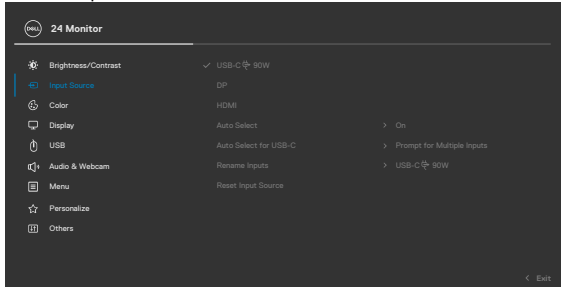

Input Source

Use the **Input Source** menu to select between different video inputs that are connected to your monitor.



USB-C 90 W 	Select USB-C 90 W input when you are using the USB-C 90 W connector. Press the joystick button to confirm the selection.
DP	Select DP (DisplayPort) input when you are using the DP (DisplayPort) connector. Press the joystick button to confirm the selection.
HDMI	Select the HDMI input when you are using the HDMI connector. Press the joystick button to confirm the selection.
Auto Select	Allows you to scan for available input sources. Press  to select this function.
Auto Select for USB-C	Press  to select these functions: <ul style="list-style-type: none"> ♦ Prompt for Multiple Inputs: always show Switch to USB-C Video Input message for user to choose whether to switch or not. ♦ Yes: The monitor always switch to USB-C video without asking while USB-C connected. ♦ No: The monitor will NOT auto switch to USB-C video from another available input.
Rename Inputs	Allows you to Rename Inputs .
Reset Input Source	Resets all settings under the Input Source menu to the factory defaults. Press  to select this function.



Icon	Menu and Submenus	Description
	Color	Adjusts the color setting mode.

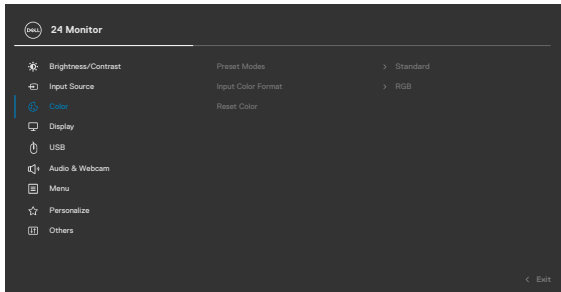

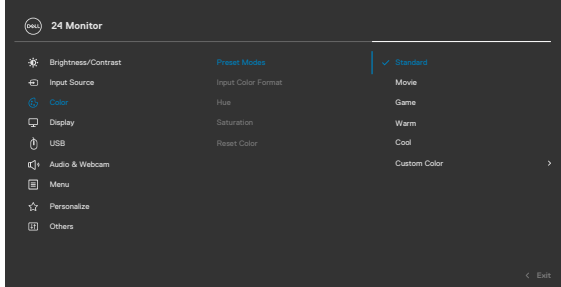

Preset Modes

When you select Preset Modes, you can choose **Standard, Movie, Game, Warm, Cool** or **Custom Color** from the list.



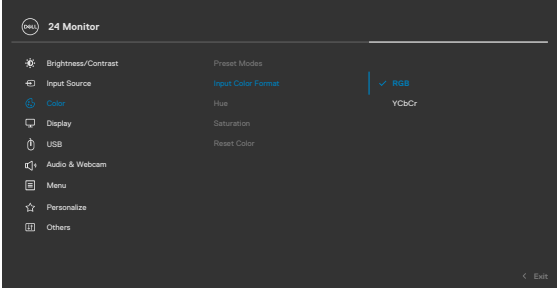

- ◆ **Standard:** Default Color setting, This monitor uses a low blue light panel, and is certified by TUV to reduce blue light output and create a more relaxing and less stimulating image while reading content on the screen.
- ◆ **Movie:** Ideal for movies.
- ◆ **Game:** Ideal for most gaming applications.
- ◆ **Warm:** Presents colors at lower color temperatures. The screen appears warmer with a red/yellow tint.





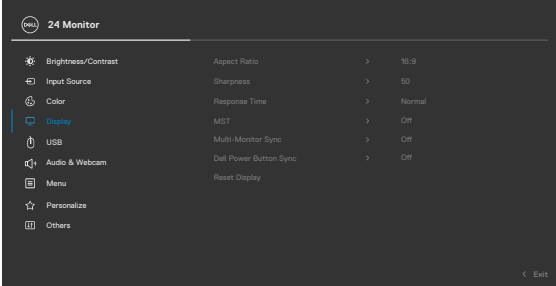

Icon	Menu and Submenus	Description
		<ul style="list-style-type: none"> • Cool: Presents colors at higher color temperatures. The screen appears cooler with a blue tint. • Custom Color: Allows you to manually adjust the color settings. Press the joystick left and right buttons to adjust the Red, Green, and Blue values and create your own preset color mode.
	Input Color Format	<p>Allows you to set the video input mode to:</p> <ul style="list-style-type: none"> • RGB: Select this option if your monitor is connected to a computer or a media player that supports RGB output. • YCbCr: Select this option if your media player supports only YCbCr output.
		 <p>The screenshot shows the '24 Monitor' OSD menu. On the left is a navigation menu with options: Brightness/Contrast, Input Source, Color, Display, USB, Audio & Webcam, Menu, Personalize, and Others. The main area is titled 'Preset Modes' and contains 'Input Color Format' (set to RGB), 'Hue', 'Saturation', and 'Reset Color'. A blue checkmark is next to 'RGB'.</p>
		 <p>A circular joystick icon with four directional arrows (Up, Down, Left, Right) and a central button.</p>
	Hue	<p>Use Joystick Up or Down to adjust the Hue from 0 to 100.</p> <p>NOTE: Hue adjustment is available only for Movie and Game mode.</p>
	Saturation	<p>Use Joystick Up or Down to adjust the Saturation from 0 to 100.</p> <p>NOTE: Saturation adjustment is available only for Movie and Game mode.</p>
	Reset Color	<p>Resets your monitor's color settings to the factory defaults. Press  to select this function.</p>



Icon	Menu and Submenus	Description
	Display	Use the Display menu to adjust image.
		
		
Aspect Ratio	Adjust the image ratio to 16:9 , 4:3 , 5:4 .	
Sharpness	Makes the image look sharper or softer. Move the joystick up and down to adjust the sharpness from '0' to '100'.	
Response Time	Allows you to set the Response Time to Normal or Fast .	
MST	DP Multi Stream Transport, Set to ON enables MST (DP out), Set to OFF disables MST function. NOTE: When DP/USB-C upstream cable and DP downstream cable is connected, monitor will set MST = ON automatically, this action will only be done once after Factory Reset or Display Reset. Please refer to Connecting the Monitor for DP Multi-Stream Transport (MST) Function .	



Icon	Menu and Submenus	Description
	Multi-Monitor Sync	Multi-Monitor Sync allows multiple monitors that are daisy chained via DisplayPort to synchronize a pre-defined group of OSD settings in the background. An OSD option, “ Multi-Monitor Sync ” will be created in Display Menu to allow user to enable/disable syncing.
	Dell Power Button Sync	To allow you to control PC system power state from the monitor power button. Allows you to On or Off Dell Power Button Sync function. NOTE: This feature is only supported with Dell platform which has built-in DPBS function, and is only supported over USB-C interface.
	Reset Display	Resets all settings under the Display menu to the factory defaults. Press  to select this function.

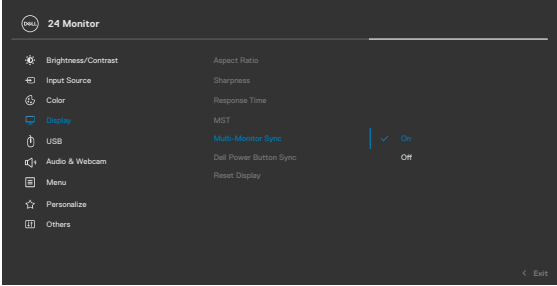

Icon	Menu and Submenus	Description
------	-------------------	-------------



USB

Allows you to set the USB upstream port for the DP/HDMI input signals, thus the monitor's USB downstream port (For example, keyboard and mouse) can be used by the current input signals when you connect a computer to either one of the upstream ports. When you use only one upstream port, the connected upstream port is active.

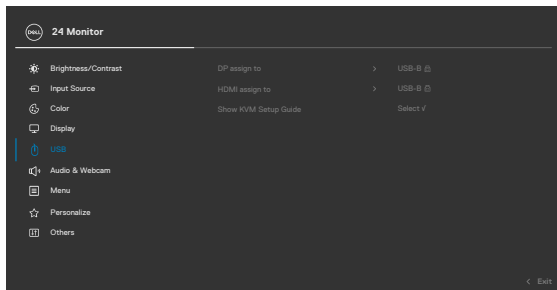



NOTE: To prevent data damage or loss, before changing USB upstream ports, make sure that no USB storage devices are in use by the computer connected to the monitor's USB upstream port.

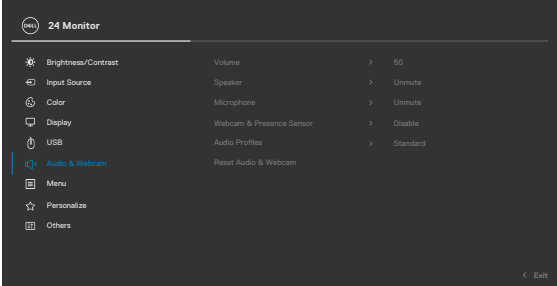

Show KVM Setup Guide

Select this option and follow steps if you want to connect multiple computers to the monitor and use one setup of keyboard and mouse.



Icon	Menu and Submenus	Description
	Audio & Webcam	Use the Audio Settings menu to adjust the audio settings.
		
		
Volume	<p>Allows you to increase the speaker volume.</p> <p>Move the joystick up and down to adjust the volume from '0' to '100'.</p>	
Speaker	Select On or Off the Speaker function.	
Microphone	Select Mute or Unmute the Microphone function.	
Webcam & Presence Sensor	<p>Select Enable or Disable the Webcam and Presence Sensor function.</p> <p>NOTE: Disabling “webcam & presence sensor” will turn off the whole webcam module, webcam and sensor will not appear in the system.</p> <p>Rotate Camera to lock and unlock camera shutter.</p>	
Audio Profiles	<p>Expand to show the various audio profiles.</p> <ul style="list-style-type: none"> • Voice mode, emphasize on speech, ideal for voice and video calls. • Movie mode, emphasizes voice and low frequency sound, for more immersive video viewing experience. • Gaming mode, boosting low and high frequencies, for an improved sense of space and orientation in gaming. • Music mode, provides a flat EQ profile, for faithful music reproduction. 	
Reset Audio & Webcam	Resets all settings under the Audio and Webcam menu to the factory preset values.	

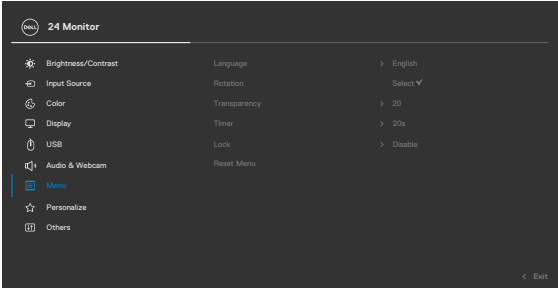

Icon	Menu and Submenus	Description
	Menu	<p>Select this option to adjust the settings of the OSD, such as the languages of the OSD, the amount of time the menu remains on screen, and so on.</p>
		
		
Language	<p>Set the OSD display to one of eight languages. (English, Spanish, French, German, Brazilian Portuguese, Russian, Simplified Chinese, or Japanese).</p>	
Rotation	<p>Rotates the OSD by 0/90/270 degrees. You can adjust the menu according to your display rotation.</p>	
Transparency	<p>Select this option to change the menu transparency by moving the Joystick up or down (Range: 0 - 100).</p>	
Timer	<p>OSD Hold Time: Sets the length of time the OSD remains active after you press a button. Move the joystick to adjust the slider in 1-second increments, from 5 to 60 seconds.</p>	



Icon	Menu and Submenus	Description
------	-------------------	-------------

Lock

With the control buttons on the monitor locked, you can prevent people from accessing the controls. It also prevents accidental activation in multiple monitors side-by-side setup.

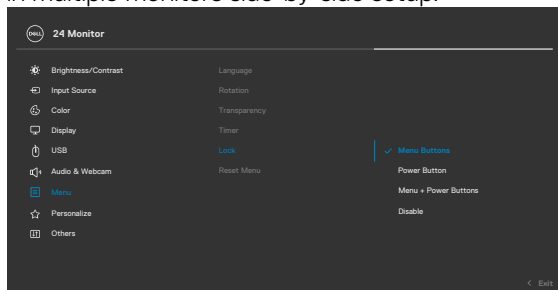



- ◆ **Menu Buttons:** Through OSD to lock the Menu buttons.
- ◆ **Power Button:** Through OSD to lock the Power button.
- ◆ **Menu + Power Buttons:** Through OSD to lock the all of Menu and Power buttons.
- ◆ **Disable:** Move the Joystick left and hold for 4 seconds.

Reset Menu

Resets all settings under the **Reset Menu** to the factory defaults. Press  to select this function.

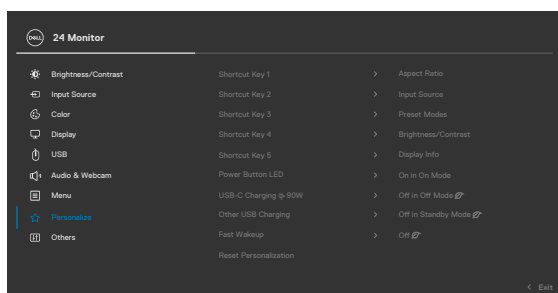
Personalize



Icon	Menu and Submenus	Description
	Shortcut key 1	
	Shortcut key 2	Select from Aspect Ratio, Input Source, Preset Modes, Brightness/Contrast, Display Info set as shortcut key.
	Shortcut key 3	
	Shortcut key 4	
	Shortcut key 5	
	Power Button LED	Allows you to set the state of the power light to save energy.
	USB-C Charging 90 W	Allows you to enable or disable USB-C Charging 90W charging function during monitor power off mode. NOTE: When this function is enabled, you will be able to charge your notebook or mobile devices through the USB-C cable even when the monitor is powered Off.
	Other USB Charging	Allows you to enable or disable Other USB Charging function during monitor Standby mode. NOTE: When this function is enabled, you will be able to charge your mobile phone through the USB-A cable even when the monitor is in standby mode.
	Fast Wakeup	Speed up recovery time from sleep mode.
	Reset Personalization	Resets all settings under the Personalize to the factory defaults. Press  to select this function.



Others

Select this option to adjust the OSD settings such as the **DDC/CI, LCD** conditioning, and so on.

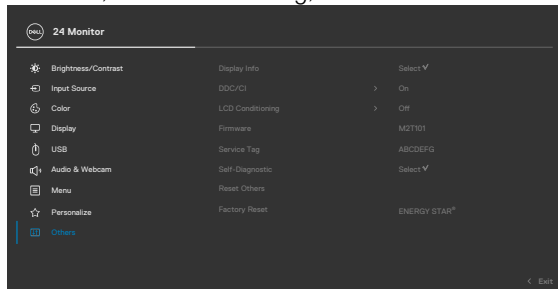

Icon	Menu and Submenus	Description
------	-------------------	-------------

Display Info

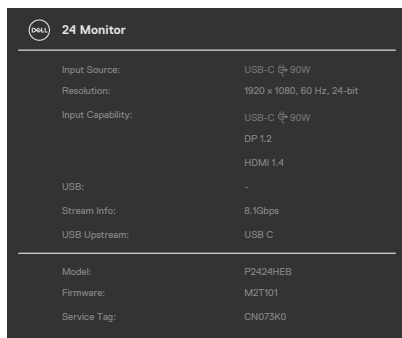

Displays the monitor's current settings. Press  to select this function.

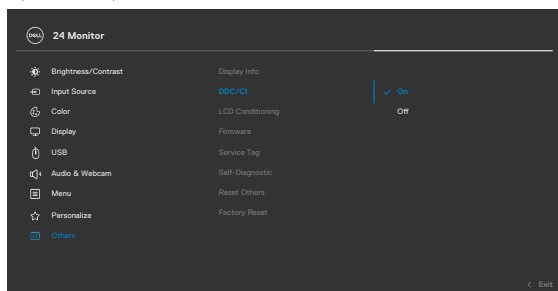

DDC/CI

DDC/CI (Display Data Channel/Command Interface) allows your monitor parameters (brightness, color balance, and etc.) to be adjustable via the software on your computer. You can disable this feature by selecting **Off**. Enable this feature for best user experience and optimum performance of your monitor.

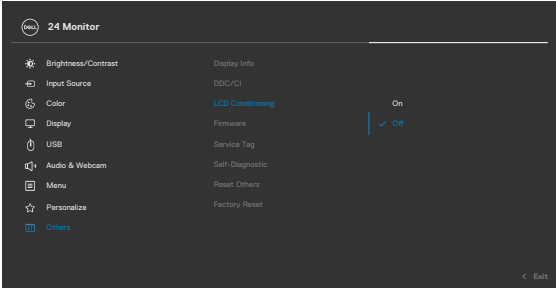

Icon	Menu and Submenus	Description
	LCD Conditioning	Helps reduce minor cases of image retention. Depending on the degree of image retention, the program may take some time to run. You can enable this feature by selecting On .
		
Firmware	Service Tag	<p>Displays the Firmware version of your monitor.</p> <p>Displays the Service Tag. The Service Tag is a unique alphanumeric identifier that allows Dell to identify the product specifications and access warranty information.</p> <p>NOTE: The Service Tag is also printed on a label located at the back of the cover.</p>
Self-Diagnostic	Reset Others	<p>Use this option to run the built-in diagnostics, see Built-in Diagnostics.</p> <p>Resets all settings under the Others menu to the factory defaults.</p> <p>Press  to select this function.</p>
Factory Reset	<p>Restores all preset values to the factory default settings. These are also the settings for ENERGY STAR® tests.</p>	



Using the OSD lock function

You can lock the front-panel control buttons to prevent access to the OSD menu and/or power button.

Use the Lock menu to lock the button(s).

1. Select one of the following options.

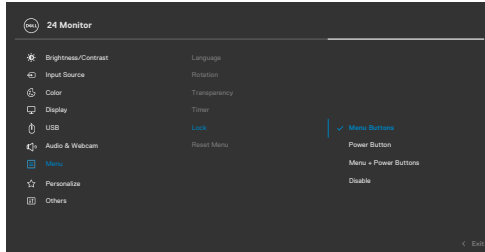

2. The following message appears.

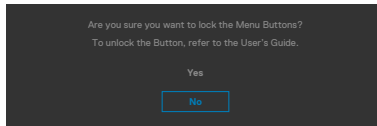

3. Select **Yes** to lock buttons. Once locked, pressing any control button will display the lock icon .



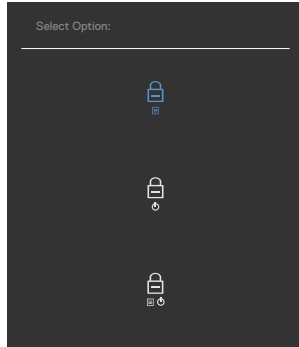

Use the Joystick to lock the button(s).

Press the left directional navigation of Joystick for four seconds, a menu appears on the screen.



Select one of the following options:



Options	Description
1  Menu Button lock	Select this option to lock OSD menu function.
2  Power Button lock	Use this option to lock power button. This will prevent the user to turn off the monitor using the power button.
3  Menu and Power Button lock	Use this option to lock OSD menu and power button to turn off the monitor.

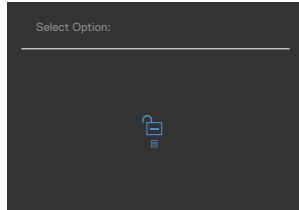

To unlock the button(s).

Press the left directional navigation of Joystick for four seconds until a menu appears on the screen. The following table describes the options to unlock the front-panel control buttons.



Options	Description
1  Menu Button unlock	Use this option to unlock OSD menu function.
2  Power Button unlock	Use this option to unlock power button to turn off the monitor.
3  Menu and Power Button unlock	Use this option to unlock OSD menu and power button to turn off the monitor.



Initial Setup

When you select OSD items of **Factory Reset** in Other feature, the following message will appear:

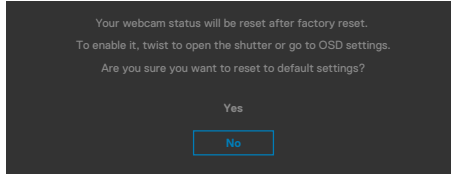

When you select '**Yes**' to reset to default settings, the following message will appear:

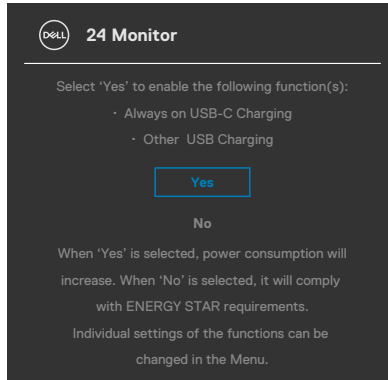

OSD warning messages

When the monitor does not support a particular resolution mode, you can see the following message:

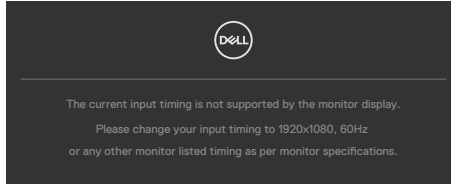

This means that the monitor cannot synchronize with the signal that it is receiving from the computer. See [Monitor Specifications](#) for the Horizontal and Vertical frequency ranges addressable by this monitor. Recommended mode is **1920 x 1080**.

You can see the following message before the DDC/CI function is disabled:

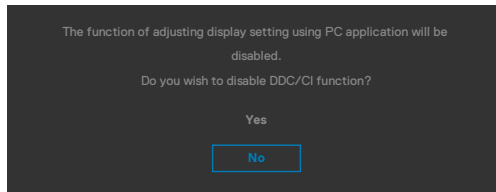

When the monitor enters the **Standby Mode**, the following message will appear:

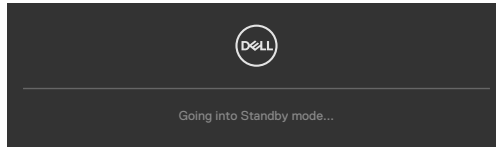

Activate the computer and wake up the monitor to gain access to the **OSD**.

If you press any button other than the power button, the following messages will appear depending on the selected input:

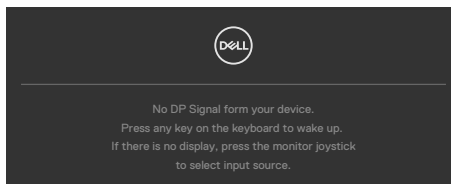

A message is displayed while the cable supporting DP alternate mode is connected to the monitor under the following conditions:

- When Auto Select for **USB-C** is set to **Prompt for Multiple Inputs**.
- When the USB-C cable is connected to the monitor.

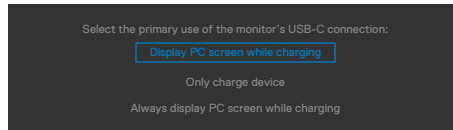

If the monitor connect with two ports or more, when the **Auto** of Input Source is selected, it will turn to the next port with signal.

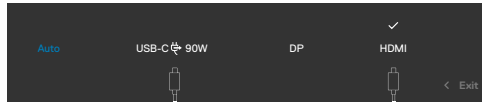

Select OSD items of **On in Standby Mode** in Personalize feature, the following message will appear:

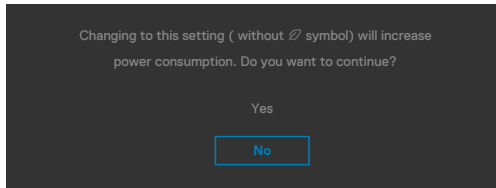

If adjust the Brightness level above the default level over 75%, the following message will appear:

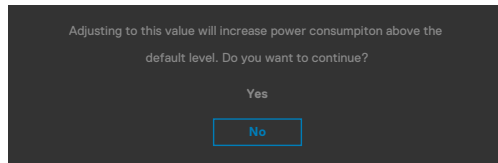

- When user selects "Yes", the power message is displayed only once.
- When user select 'No', the power warning message will pop-up again.
- The power warning message will appear again only when the user does a Factory Reset from the OSD menu.



If either USB Type-C/DP/HDMI input is selected and the corresponding cable is not connected, a floating dialog box as shown below appears.

 **NOTE: The message may be slightly different according to the connected input signal.**

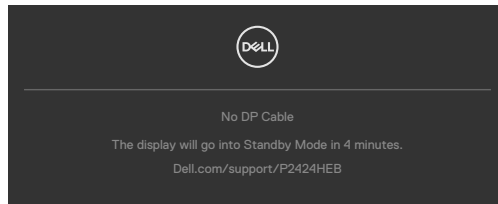

OR

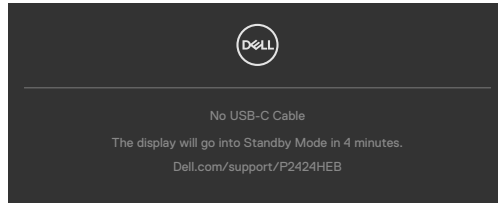

OR

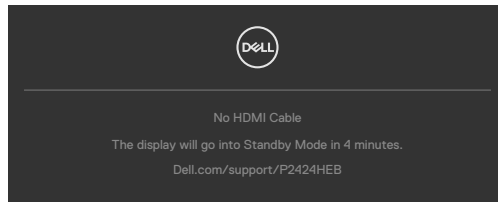

When the USB upstream cable is not connected, and you press the **Teams/ Hookswitch/Mute** button, the following message will appear:

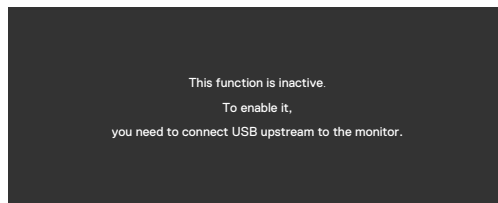

 **NOTE: For the Teams/Hookswitch/Volume down/Volume up/Mute buttons to work, you need to connect the USB upstream cable (Type-A to Type-B or Type-C to Type-C) from the PC to the monitor.**

See [Troubleshooting](#) for more information.



Setting the maximum resolution

 **NOTE: The steps may vary slightly depending on the version of Windows you have.**

To set the maximum resolution for the monitor:

In Windows 8.1:

1. For Windows 8.1, select the Desktop tile to switch to classic desktop.
2. Right-click on the desktop and click **Screen Resolution**.
3. If you have more than one monitor connected, ensure that you select **P2424HEB**.
4. Click the **Screen Resolution** dropdown list and select **1920 x 1080**.
5. Click **OK**.

In Windows 10 and Windows 11:

1. Right-click on the desktop and click **Display Settings**.
2. If you have more than one monitor connected, ensure that you select **P2424HEB**.
3. Click the **Display Resolution** dropdown list and select **1920 x 1080**.
4. Click **Keep changes**.

If you do not see **1920 x 1080** as an option, you must update your graphics driver to the latest version. Depending on your computer, complete one of the following procedures:

If you have a Dell desktop or laptop:

- Go to <https://www.dell.com/support>, enter your service tag, and download the latest driver for your graphics card.

If you are using a non-Dell computer (laptop or desktop):

- Go to the support site for your non-Dell computer and download the latest graphic card drivers.
- Go to the graphics card's website and download the latest graphic card drivers.



Multi-Monitor Sync (MMS)

Multi-Monitor Sync allows multiple monitors that are daisy chained via DisplayPort to synchronize a pre-defined group of OSD settings in the background.

An OSD option, **Multi-Monitor Sync** is available in Display Menu to allow user to enable/disable syncing.

 **NOTE: MMS is not supported over HDMI interface.**

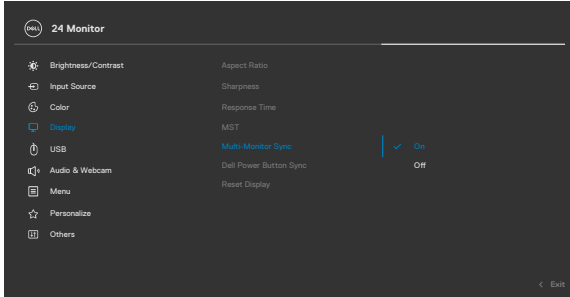

If Monitor 2 supports Multi-Monitor Sync, its MMS option will automatically be set to **On** for syncing as well.

If syncing of OSD settings across monitors is not preferred, this feature can be disabled by setting MMS option of any of the monitor to **Off**.

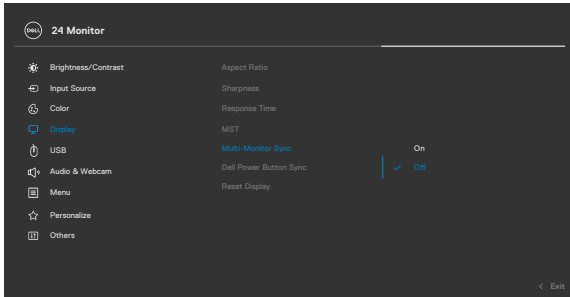

OSD Settings to be synchronized

- Brightness
- Contrast
- Preset Modes
- Color Temperature
- Custom Color (RGB Gain)
- Hue (Movie, Game mode)
- Saturation (Movie, Game mode)
- Response Time
- Sharpness



Setting Multi-Monitor Sync (MMS)

During initial power on or connection of new monitor, user setting synchronization only start if MMS is **On**. All monitor should synchronize settings from Monitor 1.

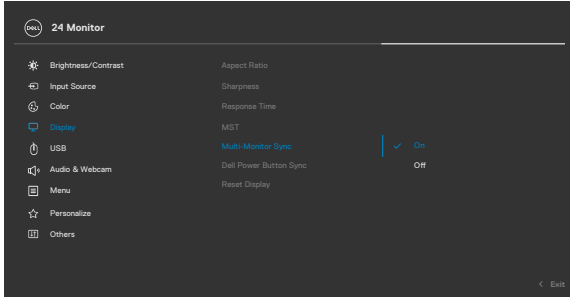

After first synchronization, subsequent syncing is driven by changes to the predefined group of OSD settings from any monitor in the chain. Any monitor may initiate the changes downstream and upstream.

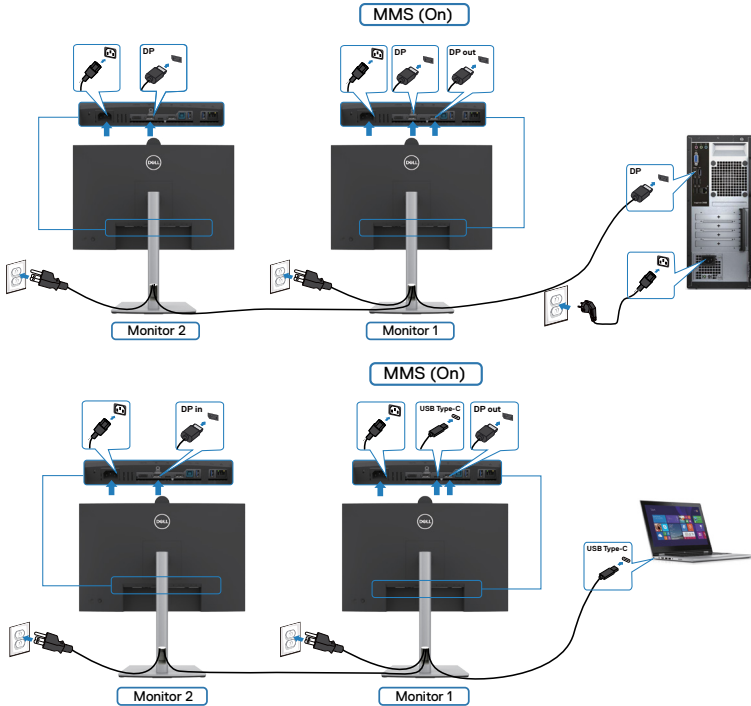

NOTE: You can use USB device on monitor 1 or monitor 2 only after you have connected the USB cable (C to A or B to A or C to C) from the computer to the monitor.



Setting up Windows Hello

In Windows® 10/Windows® 11:

Click Windows start menu, click **Settings**.

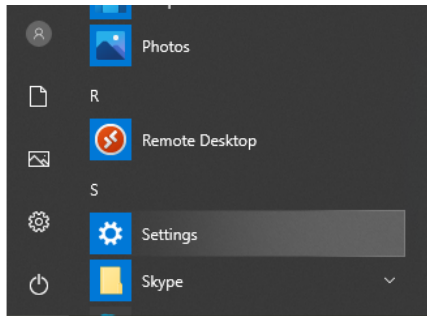

Click **Accounts**.

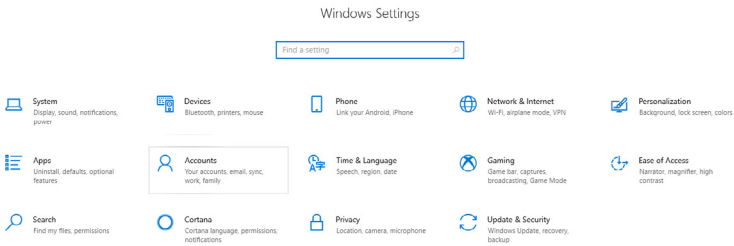

Click **Sign-in options**. You must set up a PIN before you can enroll in Windows Hello.

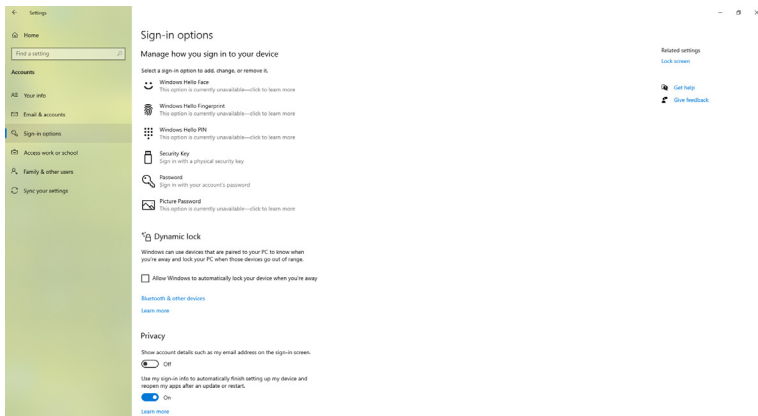

Click **Add** under **PIN** enter to **Set up a PIN**. Enter New PIN and Confirm PIN, and then click **OK**.

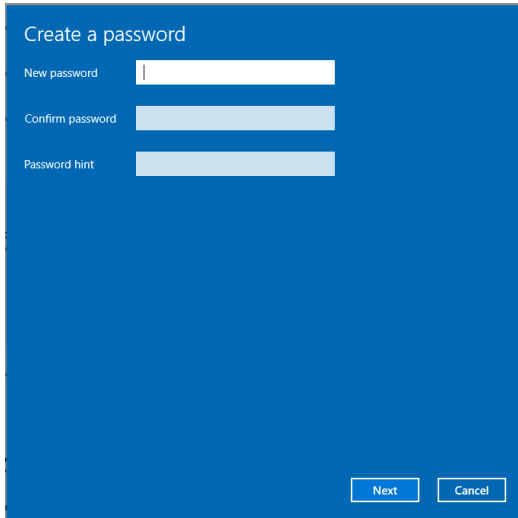

Once you've done that, the options to set up Windows Hello will unlock. Click **Set up** under **Windows Hello**, enter to **Windows Hello setup**.

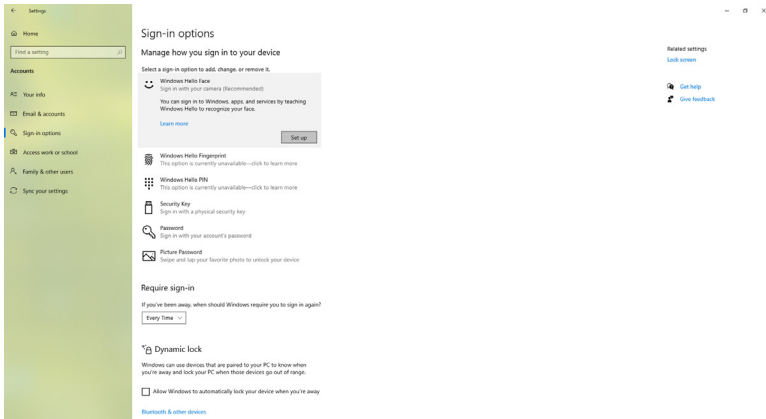

The following message is displayed, click **Get started**.

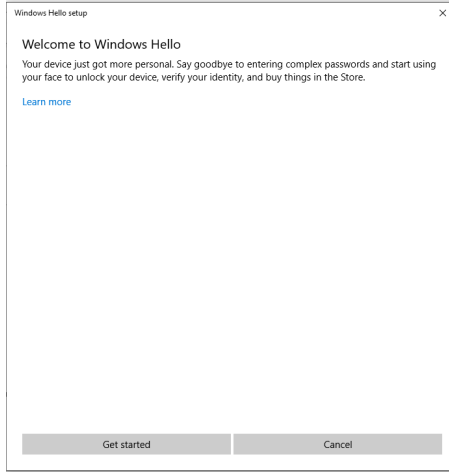

Keep looking directly at your screen and position yourself so that your face is in the center of the frame that appears on screen. The webcam will then register your face.

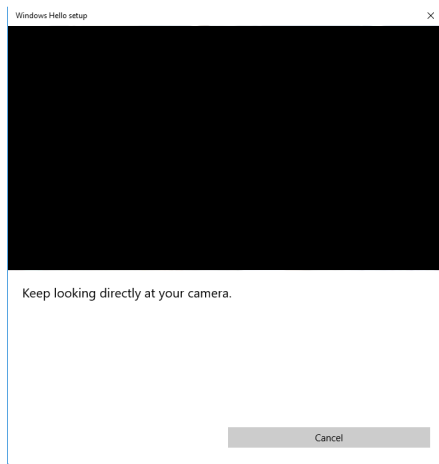

When the following message is displayed, click **Close** to exit **Windows Hello setup**.

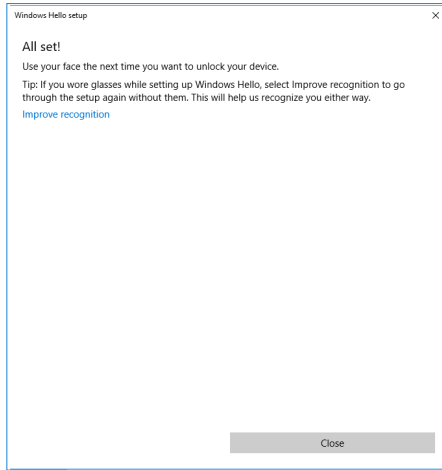

Once you have set up, you have another option to improve the recognition. Click **Improve recognition** if necessary.



Setting up the monitor webcam as default setting on the operating system

When using a notebook with built-in webcam to connect this monitor, in the device manager interface, you can find the notebook built-in webcam and the monitor webcam. Normally, they are in enable status, and the default setting is using notebook built-in webcam.

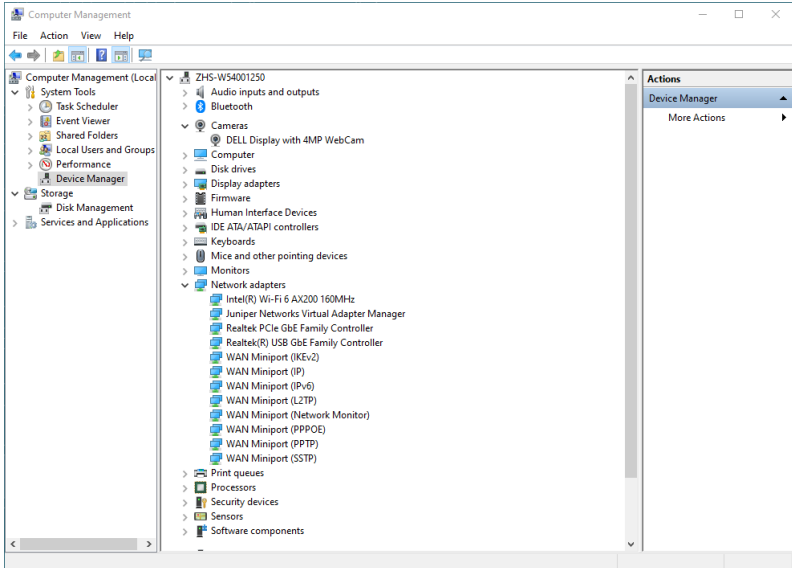

If you want to set up the monitor webcam as default setting, you need disable the notebook built-in webcam. To identify the notebook built-in webcam and disable it, please follow below instructions:

Right-click **DELL Display with 4MP WebCam**, and click **Properties** to open the **DELL Display with 4MP WebCam Properties**.

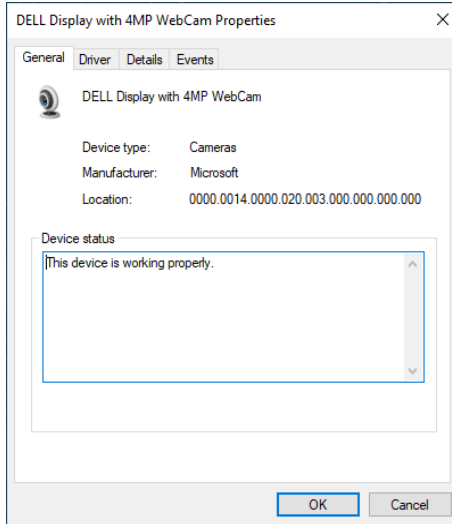
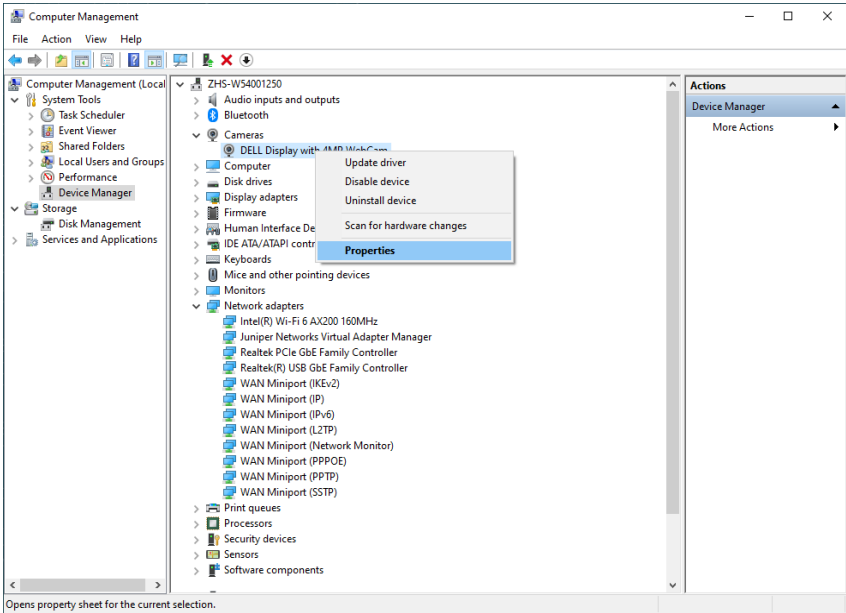

Click **Details > Property** and select **Hardware Ids**.

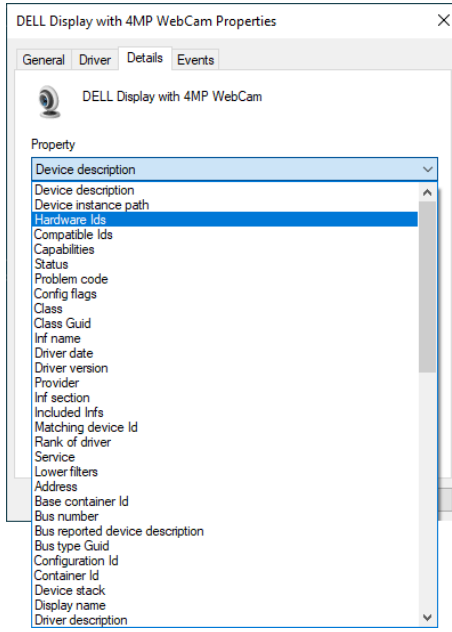

The **Value** will show the detail hardware ids of this DELL Display with 4MP WebCam. The hardware ids of the notebook built-in webcam and the monitor webcam are different. For P2424HEB, the monitor webcam hardware ids will show as below:

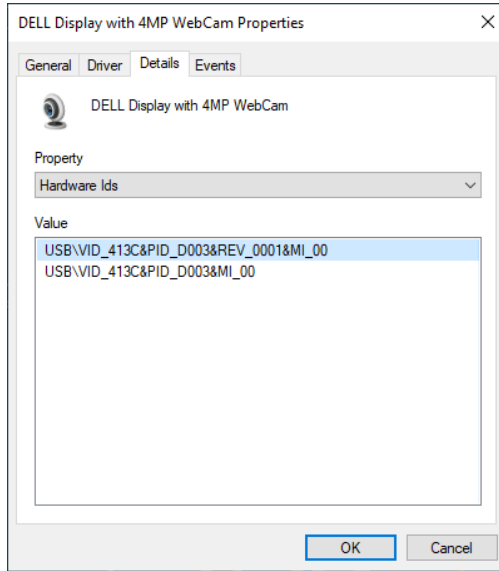

Right click the **PC/Notebook** webcam which has different hardware ids , and then click **Disable**.

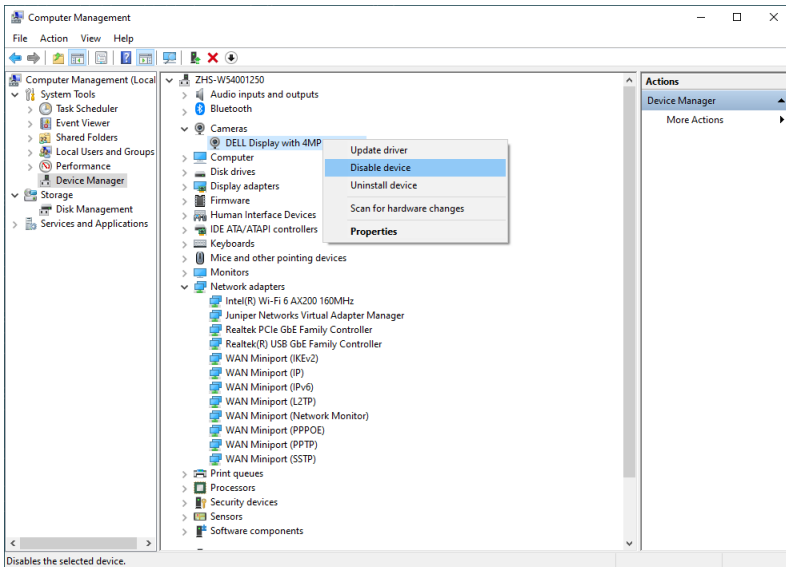

The following message is displayed:

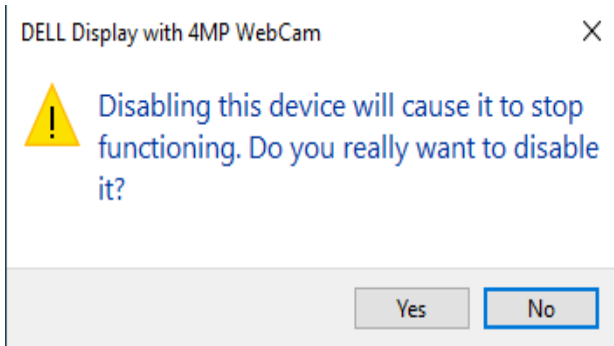

Click Yes. The notebook webcam is now disabled and the monitor webcam will be used as the default setting. Restart the notebook.

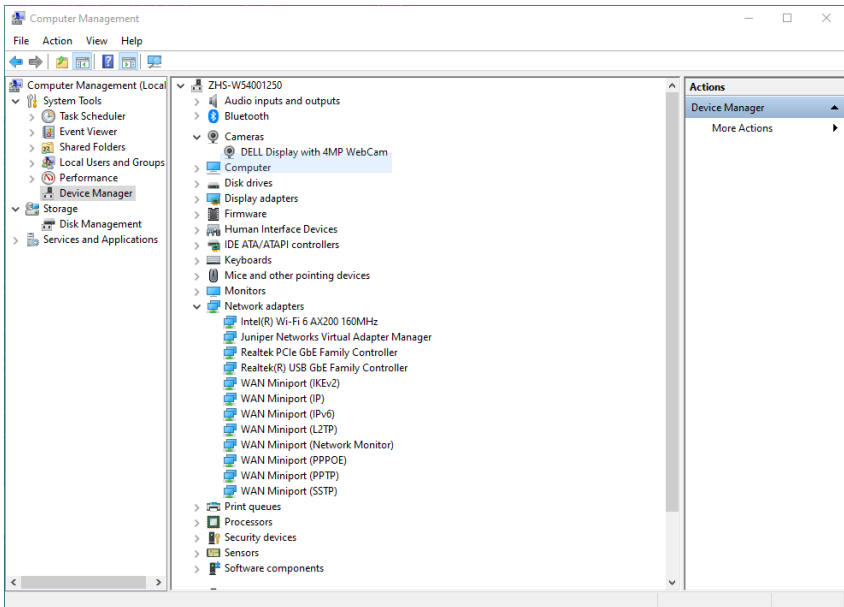

Setting up the monitor speaker as default setting on the operating system

When your computer connects multiple speakers, if you want to set up the monitor speaker as default setting, please follow below instructions:

Right-click **Volume** in the Windows task bar notification area.

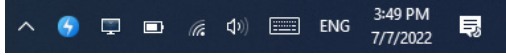

Click **Playback devices** enter to **Sound** setting interface.

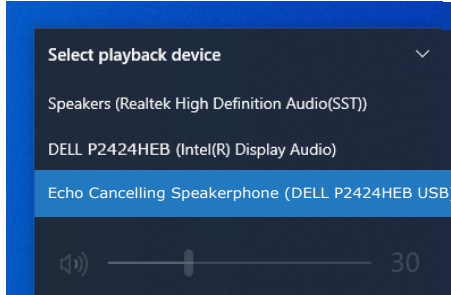

If only the HDMI or DP cable is connected from your monitor to the computer, only one speaker named **DELL P2424HEB** from the monitor will show in the **Sound** setting interface.

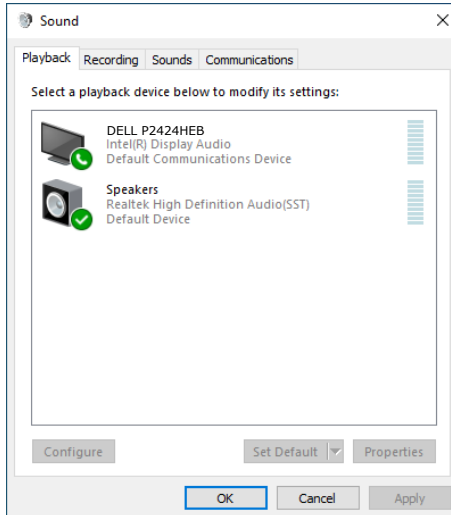

Click **DELL P2424HEB**, and then click **Set Default**, the monitor speaker will be used as the default setting.

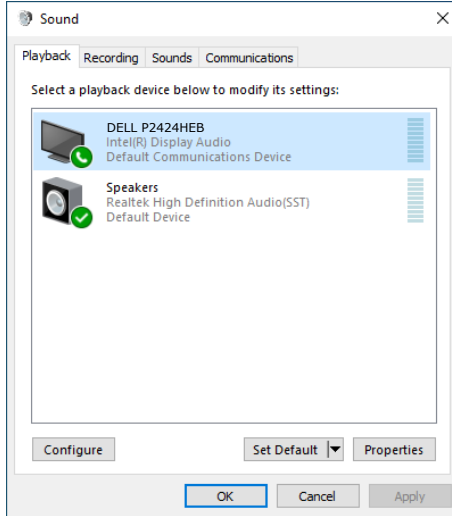

Click **OK** to exit the **Sound** setting.

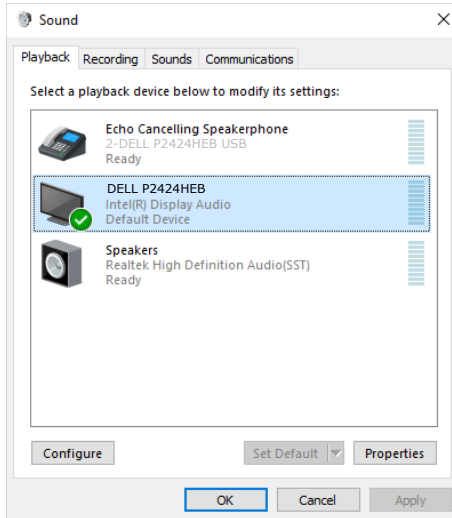

If the USB cable and the HDMI or DP cable are connected from monitor to the computer, two audio paths named **DELL P2424HEB** and **Echo Cancelling Speakerphone P2424HEB** from the monitor will show in the **Sound** setting interface. The **P2424HEB** monitor would show options for two audio paths supported in the monitor.



- **Echo Cancelling Speakerphone** audio path is where audio streams through USB. This is either through USB-C to USB-C cable or USB-A to USB-B cable. As the microphone path streams from monitor back to PC through USB, this selection is required for VoIP/UC conference applications. Audio Recording and Playback will work under this selection.
- **DELL P2424HEB** audio path is where audio streams through HDMI/DP alternate mode. Under this selection, there will not be microphone support. This selection is suitable for Audio Playback only.

The audio playback performance is the same on either of the audio path. For UC conference applications, Dell Technologies recommends selecting the default Echo Cancelling Speakerphone audio path.

 **NOTE: When you select Dell P2424HEB audio path, ensure that the Echo Cancelling Speakerphone volume is set to medium or high, otherwise the Dell P2424HEB maximum volume may sound soft as it is limited by the Echo Cancelling Speakerphone volume. For example, when the Echo Cancelling Speakerphone volume is at 50%, and the Dell P2424HEB volume is set to 100% also may have the same sound level as the former.**

Use case of monitor speaker and microphone

Audio path selection	Supported use case	
	Participate in video conference call and speak to monitor's microphone	Listen to playback audio/music/video
Echo Cancelling Speakerphone	√	√
DELL P2424HEB		√

The **Echo Cancelling Speakerphone** audio using USB path is appropriate when user wants to speak to monitor's microphone.

The Echo Cancelling Speakerphone audio path helps eliminate or reduce the occurrence of echo during a conference call. Echo refers to the unintended reflection of the user's voice back to them, which can create a distracting and unpleasant experience. You may also record your voice by using the microphone available on your monitor. The **Echo Cancelling Speakerphone** audio path is ideal for video conference calls using the Microsoft Teams or Zoom application.

The **DELL P2424HEB** audio using I2S path is appropriate when the user wants only to listen to playback audio/music/video and there is no requirement to speak or record user voice.



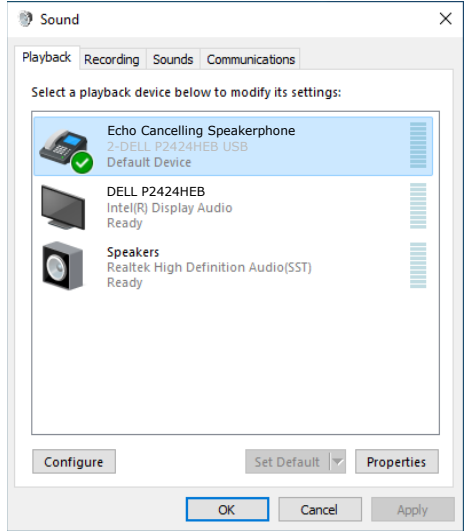
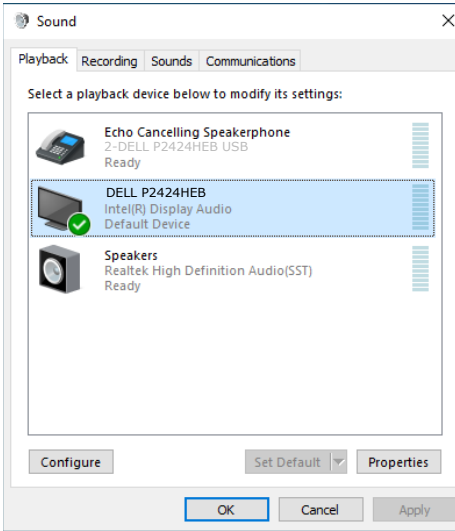

Troubleshooting

⚠ WARNING: Before you begin any of the procedures in this section, follow the [Safety Instructions](#).

Self-test

Your monitor provides a self-test feature that allows you to check whether your monitor is functioning properly. If your monitor and computer are properly connected but the monitor screen remains dark, run the monitor self-test by performing the following steps:

1. Turn off both your computer and the monitor.
2. Unplug the video cable from the back of the computer. To ensure proper Self-Test operation, remove all digital and the analog cables from the back of computer.
3. Turn on the monitor.

The floating dialog box should appear on-screen (against a black background), if the monitor cannot sense a video signal and is working correctly. While in self-test mode, the power LED remains white. Also, depending upon the selected input, one of the dialogs shown below will continuously scroll through the screen.

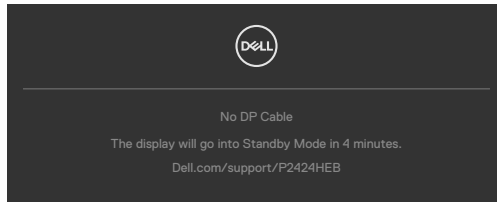

OR

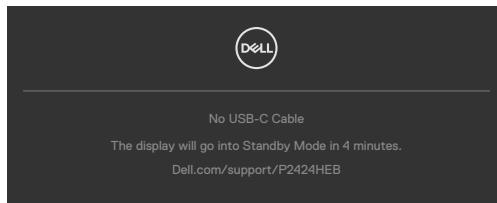

4. This box also appears during normal system operation if the video cable becomes disconnected or damaged.
5. Turn off your monitor and reconnect the video cable; then turn on both your computer and the monitor.

If your monitor screen remains blank after you use the previous procedure, check your video controller and computer, because your monitor is functioning properly.



Built-in diagnostics

Your monitor has a built-in diagnostic tool that helps you determine if the screen abnormality you are experiencing is an inherent problem with your monitor, or with your computer and video card.

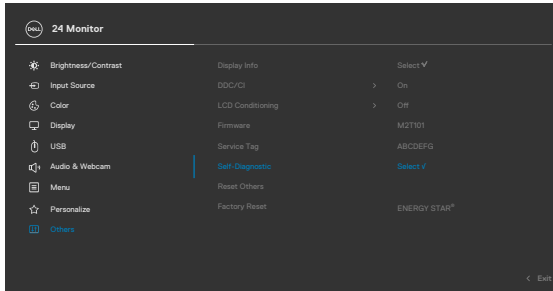

To run the built-in diagnostics:

1. Ensure that the screen is clean (no dust particles on the surface of the screen).
2. Select OSD items of Self-Diagnostics in Others feature.
3. Press the joystick button to start the diagnostics. A gray screen is displayed.
4. Observe if the screen has any defects or abnormalities.
5. Toggle the joystick once again until a red screen is displayed.
6. Observe if the screen has any defects or abnormalities.
7. Repeat steps 5 and 6 until the screen displays green, blue, black, and white colors. Note any abnormalities or defects.

The test is complete when a text screen is displayed. To exit, toggle the joystick control again.

If you do not detect any screen abnormalities upon using the built-in diagnostic tool, the monitor is functioning properly. Check the video card and computer.



Common Problems

The following table contains general information about common monitor problems you might encounter and the possible solutions:

Common Symptoms	What you experience	Possible solutions
No Video/ Power LED off	No picture	<ul style="list-style-type: none">• Ensure that the video cable connecting the monitor and the computer is properly connected and secure.• Verify that the power outlet is functioning properly using any other electrical equipment.• Ensure that the power button is depressed fully.• Ensure that the correct input source is selected in the Input Source menu.
No Video/ Power LED on	No picture or no brightness	<ul style="list-style-type: none">• Increase brightness and contrast controls via OSD.• Perform monitor self-test feature check.• Check for bent or broken pins in the video cable connector.• Run the built-in diagnostics.• Ensure that the correct input source is selected in the Input Source menu.
Missing Pixels	LCD screen has spots	<ul style="list-style-type: none">• Cycle power on-off.• Pixel that is permanently off is a natural defect that can occur in LCD technology.• For more information on Dell Monitor Quality and Pixel Policy, see Dell Support site at: https://www.dell.com/pixelguidelines.
Stuck-on Pixels	LCD screen has bright spots	<ul style="list-style-type: none">• Cycle power On-Off.• Pixel that is permanently off is a natural defect that can occur in LCD technology.• For more information on Dell Monitor Quality and PixelPolicy, see Dell Support site at: https://www.dell.com/pixelguidelines.
Brightness Problems	Picture too dim or too bright	<ul style="list-style-type: none">• Reset the monitor to factory settings.• Adjust brightness and contrast controls via OSD.
Safety Related Issues	Visible signs of smoke or sparks	<ul style="list-style-type: none">• Do not perform any troubleshooting steps.• Contact Dell immediately.



Common Symptoms	What you experience	Possible solutions
Intermittent Problems	Monitor malfunctions on & off	<ul style="list-style-type: none"> • Ensure that the video cable connecting the monitor to the computer is connected properly and is secure. • Reset the monitor to factory settings. • Perform monitor self-test feature check to determine if the intermittent problem occurs in self-test mode.
Missing Color	Picture missing color	<ul style="list-style-type: none"> • Perform monitor self-test. • Ensure that the video cable connecting the monitor to the computer is connected properly and is secure. • Check for bent or broken pins in the video cable connector.
Wrong Color	Picture color not good	<ul style="list-style-type: none"> • Change the settings of the Preset Modes in the Color menu OSD depending on the application. • Adjust R/G/B value under Custom Color in Color menu OSD. • Change the Input Color Format to PC RGB or YPbPr in the Color menu OSD. • Run the built-in diagnostics.
Image retention from a static image left on the monitor for a long period of time	Faint shadow from the static image displayed appears on the screen	<ul style="list-style-type: none"> • Set the screen to turn off after a few minutes of screen idle time. These can be adjusted in Windows Power Options or Mac Energy Saver setting. • Alternatively, use a dynamically changing screensaver.
Mic/Webcam does not work	<ul style="list-style-type: none"> • USB cable not plug in or not select the correct USB source • Not set the monitor Mic/webcam as the default device 	<ul style="list-style-type: none"> • Plug in the USB Cable (Type-A to Type-B or Type-C to Type-C), and if you connect both USB-C port and USB-B port, switch the USB source in the OSD menu. • Select the monitor Mic/webcam as the default in the PC side. • Touch the Mic button and make sure the Mic mute LED is dark.



Product specific problems

Problem	What you experience	Possible solutions
Screen image is too small	Image is centered on screen, but does not fill entire viewing area	<ul style="list-style-type: none">• Check the Aspect Ratio setting in the Display menu OSD.• Reset the monitor to factory settings.
Cannot adjust the monitor with the joystick control on the rear of the monitor	OSD does not appear on the screen	<ul style="list-style-type: none">• Turn off the monitor, unplug the monitor power cable, plug it back, and then turn on the monitor.
No Input Signal when user controls are pressed	No picture, the LED light is white	<ul style="list-style-type: none">• Check the signal source. Ensure the computer is not in the power saving mode by moving the mouse or pressing any key on the keyboard.• Check whether the signal cable is plugged in properly. Connect the signal cable again, if necessary.• Reset the computer or video player.
The picture does not fill the entire screen	The picture cannot fill the height or width of the screen	<ul style="list-style-type: none">• Due to different video formats (aspect ratio) of DVDs, the monitor may display in full screen.• Run the built-in diagnostics.
No image when using DP connection to the PC	Blank screen	<ul style="list-style-type: none">• Verify which DP standard is your Graphics Card certified to. Download and install the latest graphics card driver.• Some DP 1.1a graphics card cannot support DP 1.2/1.4 monitors.
No image when using USB Type-C connection to computer, laptop, and so on	Blank screen	<ul style="list-style-type: none">• Verify if the USB Type-C interface of the device can support DP alternate mode.• Verify if the device required more than 90 W power charging.• USB Type-C interface of device cannot support DP alternate mode.• Set Windows to Projection mode.• Ensure that the USB Type-C cable is not damaged.



Problem	What you experience	Possible solutions
No charging when using USB Type-C connection to computer, laptop, and so on	No charging	<ul style="list-style-type: none"> • Verify if the device can support one of 5 V/9 V/15 V/20 V charging profiles. • Verify if the Notebook requires a >90 W power adaptor. • If the Notebook requires a >90 W power adaptor, it may not charge with the USB Type-C connection. • Ensure that you use only Dell approved adapter or the adapter that comes with the product. • Ensure that the USB Type-C cable is not damaged.
Intermittent charging when using USB Type-C connection to computer, laptop, and so on	Intermittent charging	<ul style="list-style-type: none"> • Check if the maximum power consumption of device is over 90 W. • Ensure that you use only Dell approved adapter or the adapter that comes with the product. • Ensure that the USB Type-C cable is not damaged.
No image when using USB Type-C MST	Blank screen or 2 nd DUT is not Prime mode	<ul style="list-style-type: none"> • USB Type-C input, Go to OSD menu, under Display Info check the Link Rate is HBR2 or HBR3, if Link Rate is HBR2, suggest to use USB Type-C to DP cable to turn on MST.
No network connection	Network dropped or Intermittent	<ul style="list-style-type: none"> • Do not toggle Off/On the power button when network is connected, keeps the power button On.



Problem	What you experience	Possible solutions
The LAN port is not functioning	OS setting or cable connection issue	<ul style="list-style-type: none"> • Ensure that the latest BIOS and drivers for your computer are installed on your computer. • Ensure that the RealTek Gigabit Ethernet Controller is installed in the Windows Device Manager. • If your BIOS Setup has a LAN/GBE Enabled/Disabled option, make sure it is set to Enabled. • Ensure that the Ethernet cable is connected securely on the monitor and the hub/router/firewall. • Check the status LED of the Ethernet cable to confirm connectivity. Re-connect both ends of the Ethernet cable if the LED is not lit. • First power off the Computer and unplug the Type-C cable and power cord of the monitor. Then, power on the computer, plug in the monitor power cord and Type-C cable.
Monitor buttons (Mute/Volume down/Volume up/Hookswitch) not working with Microsoft Teams® App	Monitor buttons (Mute/Volume down/Volume up/Hookswitch) not working on Microsoft Teams® App with Chrome OS/Ubuntu	<p>Use Microsoft Teams® App to perform the below tasks:</p> <ul style="list-style-type: none"> • Call Icon to accept/hang up call • Volume down/Volume up adjustment • Mic mute/unmute • Video on/off
Headset with Mic (3.5mm combo jack) not working with monitor mute/unmute button	Headset with Mic (3.5mm combo jack) not working with monitor mute/unmute button	<ul style="list-style-type: none"> • Use UC App (e.g. Microsoft Teams, Skype for Business, Zoom, etc.) Mic Icon to mute/unmute • Select 'Echo Cancelling Speakerphone' audio path in the 'Sounds Setting' on UC application. • Connect the USB-C to C cable or USB-A to B cable.



Problem	What you experience	Possible solutions
When press either Volume down/Volume up or Mute button, LED not blink	When press either Volume down/Volume up or Mute button, LED not blink when connected to HDMI or DP only	Connect USB-A to USB-B cable
Webcam or Mic not working	Webcam or Mic not working when connected to HDMI or DP only	Connect USB-A to USB-B cable
Ethernet port (RJ45) cannot connect to internet	Ethernet port (RJ45) cannot connect to internet on Win 10/Win 11	Change the LAN Controller Power Saving from Enable to Disable
No sound coming from the speakers	No sound coming from the speakers when play audio/video on your system	<ul style="list-style-type: none"> • Ensure that you have set the default playback device as Echo Cancelling Speakerphone or DELL P2424HEB on your system. • Turn Off the monitor, unplug the monitor power cord, replug it, and then turn On the monitor. • Reset the monitor to Factory Settings.



Problem	What you experience	Possible solutions
Speaker volume is low/sounds soft	Speaker volume is low/sounds soft when speaker option is DELL P2424HEB in Sound setting interface	<ul style="list-style-type: none"> • Increase the speaker volume of DELL P2424HEB to maximum in the Sound setting interface • Press the Volume Up button to increase the speaker volume of DELL P2424HEB • If you select DELL P2424HEB audio path, please ensure that the Echo Cancelling Speakerphone volume is set to medium or high. Else, the DELL P2424HEB maximum volume may sound soft because it is limited by the Echo Cancelling Speakerphone volume. For example, when the Echo Cancelling Speakerphone volume is at 50%, and the DELL P2424HEB volume is set to 100% will have the same sound level as the former.
No sound from speaker	No sound from monitor's speaker when in Teams/ Zoom call.	<ul style="list-style-type: none"> • Select the same audio path in the Teams/ Zoom application as the operating system's Sound setting.
Monitor's Volume up/ Volume down buttons not sync with OS	Pressing the Volume up/Volume down buttons on the monitor does not increase or decrease the volume on the OS.	<ul style="list-style-type: none"> • Select 'Echo Cancelling Speakerphone' audio path on the operating system's Sound setting of your laptop. • Select 'Echo Cancelling Speakerphone' audio path on the UC application. • Connect the USB-C to C cable or USB-A to B cable.



Problem	What you experience	Possible solutions
Webcam is not detected	Webcam is not detected in the Windows Device Manager	<ul style="list-style-type: none"> • Ensure that the USB upstream cable is connected between the monitor and the computer or notebook. • Ensure that the Webcam & Presence Sensor in OSD is set to Enable. • Reconnect the USB upstream cable to the computer or notebook.
	Webcam is not detected in the Dell Peripheral Manager for Windows software	<ul style="list-style-type: none"> • To support the P2424HEB monitor, please use the Dell Peripheral Manager version 1.7.0 or later.
Webcam cannot connect/ Webcam disconnected	Could not detect Monitor camera/ Could not switch back to the PC camera	<ul style="list-style-type: none"> • Reset the monitor to factory settings. • Turn off the monitor, unplug the monitor power cord, replug it, and then turn on the monitor. • Select the monitor camera again in the Camera/Video setting on your UC conference application.
	Microphone is muted in the Windows Device Manager	<ul style="list-style-type: none"> • Ensure that the USB upstream cable is connected between the monitor and the computer or notebook. • Ensure that the 'Microphone' in OSD is set as Unmute. • Reconnect the USB upstream cable to the computer or notebook. • Ensure that the microphone is enabled/unmuted on the monitor. If the microphone mute LED is lighting up in static red (indicates microphone muted), press the microphone button to unmute the microphone. • Ensure that the monitor's microphone is selected and enabled/unmuted on the setting in the UC application.



Problem	What you experience	Possible solutions
Microphone volume is low/sounds soft	Microphone volume is low /sounds soft to the other participant when in audio/video call	<ul style="list-style-type: none"> • Ensure the Mute button's LED go dark (indicates microphone unmuted). • Adjust the distance between the user and the microphone. The user should avoid sitting too far away from the microphone. The most optimum distance between the user and the microphone is 70 cm. • Ensure that the monitor's microphone is selected and enabled/unmuted on the setting in the UC application. • Increase the microphone volume in the Sound setting interface at the PC side/in the UC application.
Front buttons don't work	No response on the UC application when press on the buttons located on the speaker	<ul style="list-style-type: none"> • Ensure that the USB upstream cable (Type-A to Type-B or Type-C to Type-C) is connected from the PC to the monitor. • For some UC platforms/applications, the Mute function works by pressing the Mute button, but the Mute Icon on the UC platform is not sync (Icon shows unmute).
Webcam image looks over-exposed	Webcam image shows over-exposed background	<ul style="list-style-type: none"> • Adjust the environment lighting condition. Ensure the monitor is setup at a well lighted environment, preferably under ceiling lights. The user should avoid a dim/dark background. The user should avoid direct facing a window with bright sunlight. • Alternatively, you may use Dell Peripheral Manager to adjust the webcam setting on color.
Webcam image looks grainy/dark	Webcam image appears grainy/dark	<ul style="list-style-type: none"> • Adjust the environment lighting condition. Ensure the monitor is setup at a well lighted environment, preferably under ceiling lights. The user should avoid a dim environment.



Problem	What you experience	Possible solutions
Webcam image looks blurry	Webcam image appears blurry/not clear.	<ul style="list-style-type: none"> Use a clean and slightly damp cloth to wipe the surface of the front webcam. Adjust the distance between the user and the camera. The user should avoid sitting too far away from the camera. The most optimum distance between the user and the camera is 70 cm.
Teams Microphone volume	Teams Microphone volume is lower than Zoom	<ul style="list-style-type: none"> This is normal behavior as the volume specifications are different between Teams and Zoom.
Teams/Zoom small window distorted	Teams/Zoom small window image distorted	<ul style="list-style-type: none"> This is normal behavior. The resolution of the small images are compressed when the main image is in high resolution (2K). If a lower resolution (720P & 1080P) is selected, there will not be any difference between the images.
Image quality poor	The image quality of the monitor was poor	<p>Always poor:</p> <ul style="list-style-type: none"> Check that your computer is USB 3.0-capable. Some computers have USB 3.0, USB 2.0, and USB 1.1 ports. Ensure that the correct USB port is used. <p>Sometime poor:</p> <ul style="list-style-type: none"> Network will effect the image quality,ensure your network is fine.
Proximity sensor does not work	Presence detection/wake-up not working	<ul style="list-style-type: none"> When using Teams/Zoom call, the wake up function not working is normal. It works when a user is not using Teams/Zoom.
The recording video blurred out.	Change monitor Camera resolution to 480p, Record with the camera app, save and playback the recording. There will show Mosaic in the video.	<ul style="list-style-type: none"> Change monitor camera resolution to 720p or higher.



Problem	What you experience	Possible solutions
The USB device cannot work on 2 nd monitor (MST)	<p>Platform connect to dock with USB-C cable.</p> <p>Connect 1st monitor with DP cable and a USB-A to USB-C cable to Docking.</p> <p>Connect DP cable from 1st monitor (DP Out) to 2nd monitor (DP Port).</p> <p>Connect USB A-C cable from 1st monitor (USB-A) to 2nd monitor (USB-C).</p> <p>The USB device cannot work on 2nd monitor.</p>	<ul style="list-style-type: none"> · Exceed USB hub topology · Workaround: Option 1: Without the dock, just direct connect the computer and the two monitors. Option 2: If a dock is needed, do not use the USB hub of the 2nd monitor.
Notebook not charging via USB-C	Notebook ≥ 180W not charging when connected to P2424HEB monitor USB-C port	<ul style="list-style-type: none"> · Connect the Notebook with Power adaptor
Notebook cannot power on	When the Notebook battery is at 0%, Notebook cannot power on when connecting USB-C cable to monitor	<ul style="list-style-type: none"> · Connect the Notebook with Power adaptor



Problem	What you experience	Possible solutions
The wireless mouse does not work smoothly and pauses.	Connect USB up-stream cable to the DUT. More than one meter away, 2.4Ghz mouse does not work.	<ul style="list-style-type: none"> Workaround: <ol style="list-style-type: none"> connect to Quick Access Port Connect USB 2.4Ghz dongle via USB-A Male to Female cable (0.5M)
Black screen shows up on monitor after Mac book restarting system under lid closing.	When you close the lid of your Mac book and restart your Mac book, the monitor will show black screen.	<ul style="list-style-type: none"> Move the mouse or hit the keyboard to wake up the Mac book. Turn on the monitor setting of fast wakeup, Personalize -> Fast Wakeup -> on.

Microsoft® Teams®/Skype for Business® specific problems

Problem	What you experience	Possible solutions
The Teams button is not working	Short press on the Teams button does not bring up Teams application to the foreground	<ul style="list-style-type: none"> Ensure that the USB upstream cable (Type-A to Type-B or Type-C to Type-C) is connected from the PC to the monitor. Ensure that the Teams application is signed in and is already running at the background. The Teams button's LED will light in static white. Ensure that the Teams account is provisioned/setup as 'Teams Only' mode. The tenant administrator should enable the account to 'Teams Only' mode. Teams button will only work with Teams application in 'Teams Only' mode. Setting might vary in corporate environment, resulting in Teams button not working on the monitor. Please check with your system administrator.



Problem	What you experience	Possible solutions
The Hookswitch button is not working	Short press on the Hookswitch button does not answer call	<ul style="list-style-type: none"> • Ensure that the USB upstream cable (Type-A to Type-B or Type-C to Type-C) is connected from the PC to the monitor. • Ensure that the Teams account is provisioned/setup as 'Teams Only' mode. The tenant administrator should enable the account to 'Teams Only' mode.
The Mute button is not working	Press on the Mute button does not mute and unmute microphone	<ul style="list-style-type: none"> • Ensure that the USB upstream cable (Type-A to Type-B or Type-C to Type-C) is connected from the PC to the monitor. • Ensure that the Mute button's LED will go dark (indicates microphone unmuted). • Ensure that the Teams account is provisioned/setup as 'Teams Only' mode. The tenant administrator should enable the account to 'Teams Only' mode.
Webcam no image	Webcam no image when using Skype for Business (SfB)	<ul style="list-style-type: none"> • Ensure that the USB upstream cable (Type-A to Type-B or Type-C to Type-C) is connected from the PC to the monitor. • Select 'DELL Monitor RGB Webcam' as the camera in Skype Video Device setting.
Webcam being occupied	Webcam being occupied and can't be used	<ul style="list-style-type: none"> • Avoid running multiple conference softwares at the same time. While you are using 'conference software A', close the other 'conference software B'.



Universal Serial Bus (USB) specific problems

Specific Symptoms	What you experience	Possible solutions
USB interface is not working	USB peripherals are not working	<ul style="list-style-type: none">• Check that your display is turned ON.• Reconnect the upstream cable to your computer.• Reconnect the USB peripherals (downstream connector).• Turn off the monitor and turn it on again.• Reboot the computer.• Certain USB devices such as portable hard drives require higher power source; connect the drive to the computer directly.
super speed USB 3.2 Gen1 interface is slow.	super speed USB 3.2 Gen1 peripherals working slowly or not working at all	<ul style="list-style-type: none">• Check that your computer is USB 3.0-capable.• Some computers have USB 3.0, USB 2.0, and USB 1.1 ports. Ensure that the correct USB port is used.• Reconnect the upstream cable to your computer.• Reconnect the USB peripherals (downstream connector).• Reboot the computer.
Wireless USB peripherals stop working when a USB 3.0 device is plugged in	Wireless USB peripherals responding slowly or only working as the distance between itself and its receiver decreases	<ul style="list-style-type: none">• Increase the distance between the USB 3.0 peripherals and the wireless USB receiver.• Position your wireless USB receiver as close as possible to the wireless USB peripherals.• Use a USB-extender cable to position the wireless USB receiver as far away as possible from the USB 3.0 port.



Regulatory information

FCC notices (U.S. Only) and other regulatory information

For FCC notices and other regulatory information, see the regulatory compliance website located at https://www.dell.com/regulatory_compliance.

EU product database for energy label and product information sheet

P2424HEB: <https://eprel.ec.europa.eu/qr/1378986>



Contacting Dell

For customers in the United States, call 800-WWW-DELL (800-999-3355).

 **NOTE: Availability varies by country and product, and some services may not be available in your country.**

 **NOTE: If you do not have an active Internet connection, you can find contact information on your purchase invoice, packing slip, bill, or Dell product catalog.**

Dell provides several online and telephone-based support and service options. Availability varies by country and product, and some services may not be available in your area.

- To get online monitor support content, see <https://www.dell.com/support/monitors>.
- To contact Dell for sales, technical support, or customer service issues, see <https://www.dell.com/contactdell>.

