



USER MANUAL

MODEL:

KDS-100EN / KDS-100DEC

4K AVoIP H.264 / H.265 Encoder / Decoder



Contents

Contents	2
Introduction	3
Getting Started	3
Overview	4
Typical Applications	5
Controlling your KDS-100 device	6
Defining the KDS-100	7
Defining KDS-100EN	7
Defining KDS-100DEC	9
Mounting KDS-100	11
Connecting KDS-100	12
Connecting KDS-100EN to KDS-100DEC	12
Connecting RS-232	13
Connecting the Audio/Input Output	14
Installing the SFP transceiver (optical SM/MM or copper)	14
Operating and Controlling KDS-100 Devices	15
Configuring the Network Switch	15
Using the Channel Selection Buttons	15
Operating via Ethernet	16
KDS-100EN: Using the Embedded Web Pages	19
Dashboard: <i>Set channel and audio, view input signal</i>	20
Streaming: <i>Multicast settings and time to live</i>	21
Encoding: <i>Method, protocol, scaling, bitrate and more</i>	22
EDID: <i>Set display metadata</i>	24
Gateway: <i>RS-232 settings</i>	25
Device: <i>General device, network and time settings</i>	26
Security: <i>Passwords, HTTPS and 802.1X</i>	29
About: <i>Web version and contact details</i>	32
KDS-100DEC: Using the Embedded Web Pages	33
Dashboard: <i>Set channel and audio, view input signal</i>	34
Video: <i>Decoding method and output resolution</i>	36
External Devices: <i>Connecting External RTSP Streams</i>	37
EDID: <i>Set display metadata</i>	39
Gateway: <i>RS-232 settings</i>	40
Device: <i>General device, network and time settings</i>	41
Security: <i>Passwords, HTTPS and 802.1X</i>	44
About: <i>Web version and contact details</i>	47
Upgrading Firmware	48
Technical Specifications	49
KDS-100EN Specifications	49
KDS-100DEC Specifications	50
Default Communication Parameters	51
Protocol 3000	52
Understanding Protocol 3000	52
Protocol 3000 Commands	53
Result and Error Codes	64

Introduction

Welcome to Kramer Electronics! Since 1981, Kramer Electronics has been providing a world of unique, creative, and affordable solutions to the vast range of problems that confront the video, audio, presentation, and broadcasting professional on a daily basis. In recent years, we have redesigned and upgraded most of our line, making the best even better!

Getting Started

We recommend that you:

- Unpack the equipment carefully and save the original box and packaging materials for possible future shipment.
- Review the contents of this user manual.



Go to <https://www.kramerav.com/downloads/kds-100en> or <https://www.kramerav.com/downloads/kds-100dec> to check for up-to-date user manuals, application programs, and to check if firmware upgrades are available (where appropriate).

Achieving Best Performance

- Use only good quality connection cables (we recommend Kramer high-performance, high-resolution cables) to avoid interference, deterioration in signal quality due to poor matching, and elevated noise levels (often associated with low quality cables).
- Do not secure the cables in tight bundles or roll the slack into tight coils.
- Avoid interference from neighboring electrical appliances that may adversely influence signal quality.
- Position your Kramer **KDS-100EN** / **KDS-100DEC** away from moisture, excessive sunlight and dust.

Safety Instructions



Caution:

- This equipment is to be used only inside a building. It may only be connected to other equipment that is installed inside a building.
- For products with relay terminals and GPIO ports, please refer to the permitted rating for an external connection, located next to the terminal or in the User Manual.
- There are no operator serviceable parts inside the unit.



Warning:

- If not using PoE, use only the optional power cord supplied for the unit.

Recycling Kramer Products

The Waste Electrical and Electronic Equipment (WEEE) Directive 2002/96/EC aims to reduce the amount of WEEE sent for disposal to landfill or incineration by requiring it to be collected and recycled. To comply with the WEEE Directive, Kramer Electronics has made arrangements with the European Advanced Recycling Network (EARN) and will cover any costs of treatment, recycling and recovery of waste Kramer Electronics branded equipment on arrival at the EARN facility. For details of Kramer's recycling arrangements in your particular country go to our recycling pages at www.kramerav.com/quality/environment.

Overview

KDS-100 series devices deliver a complete and versatile AVoIP streaming solution for 1GE (1Gbps) networks making the most of the H.264/265 open standard. KDS-100 is ideal for any space or use-case requiring low-latency, high-quality video presentation up to 4K60 4:2:2, such as operations rooms, university auditoriums, highly secure command and control centers, and AVoIP distribution deployments.

KDS-100 series is extremely bandwidth-efficient, making it perfect for deployment over an existing IT network. KDS-100 supports up to 1000 video sources, enables simple and fast deployment, and easily scales to suit any size network AV installation.

Delivering a superior user experience, enterprise IT-grade security and advanced, yet intuitive management, KDS-100 meets all the streaming needs of enterprise, education, homeland security, military or government sites of any size. KDS-100 is part of Kramer's market-leading KDS family, the broadest range of AVoIP streaming solutions available today

Kramer **KDS-100EN** is an advanced transmitter for streaming 4K@60Hz video signals via Ethernet over copper or fiber cables. It encodes and streams over an IP network from HDMI input, and transmits IR, RS-232 or CEC signals over IP network.

Kramer **KDS-100DEC** decoder is an advanced receiver for streamed 4K@60Hz video signals via Ethernet over copper or fiber cables. It also decodes the RS-232 or CEC signals transmitted over IP network from the encoder.

Highest-Quality Video

Support for 4K60 4:2:2 video streaming ensures finely detailed images are transmitted in full quality matching the high-end capabilities of displays.

Supports Direct Recording

Allows direct and simple recording of the meeting or transmitted content through network video recorder (NVR) devices, meeting the requirements of government sites for efficient, always-activated recording.

Exceptional Quality

- **Robust Solution for Large-Scale Installations** — The KDS-100 line provides an optimized solution for large education and enterprise campuses, and for defense and homeland security facilities, with support for numerous simultaneous video flows and built-in advanced management capabilities.
- **Highly Scalable** — The KDS-100 line supports up to 1000 video sources and is suited for large-scale installations.
- **Built-in Resilient Security Features** — The KDS-100 line preserves the integrity, availability and confidentiality of the IT network via a highly secured and resilient AVoIP solution.
KDS-100 devices comply with IT security requirements, including 802.1x and HTTPS/TLS.
- **Instant switching** - Optimized for fast switching between streams. Switching takes just 1 second or less.

Advanced and User-friendly Operation

- **Simple Planning and Rollout** — KDS-100 is highly bandwidth-efficient, thus enabling cost-efficient hybrid use of the existing 1GE IT network. There is no need to deal with complex IP packets prioritization or switching settings. Offering easy management, high reliability, and adjustable bandwidth control, KDS-100 is extremely cost-effective to maintain over the long term.
- **Alternative Sources/Destinations** — An HDMI loop-through port on the encoder side and an HDMI input port on the decoder, as well as embedding and de-embedding analog audio to the IP stream.

Typical Applications

KDS-100EN is ideal for the following typical applications:

- Real-time essential installations such as command and control rooms.
- Large scale AV content sharing installations using existing wires and infrastructure in corporate offices and government applications.
- AV distribution systems with one or more sources and multiple displays in schools, universities, and public venues.

Controlling your KDS-100 device

Control your KDS-100 device via:

- **The Ethernet** using built-in user-friendly web pages: See [Operating via Ethernet](#) on page 16.
- **Protocol 3000** (API) commands: See [Protocol 3000](#) on page 52.
- Use **the channel selection button** to set the broadcast channel: See [Using the Channel Selection Buttons](#) on page 15.

Defining the KDS-100

Defining KDS-100EN

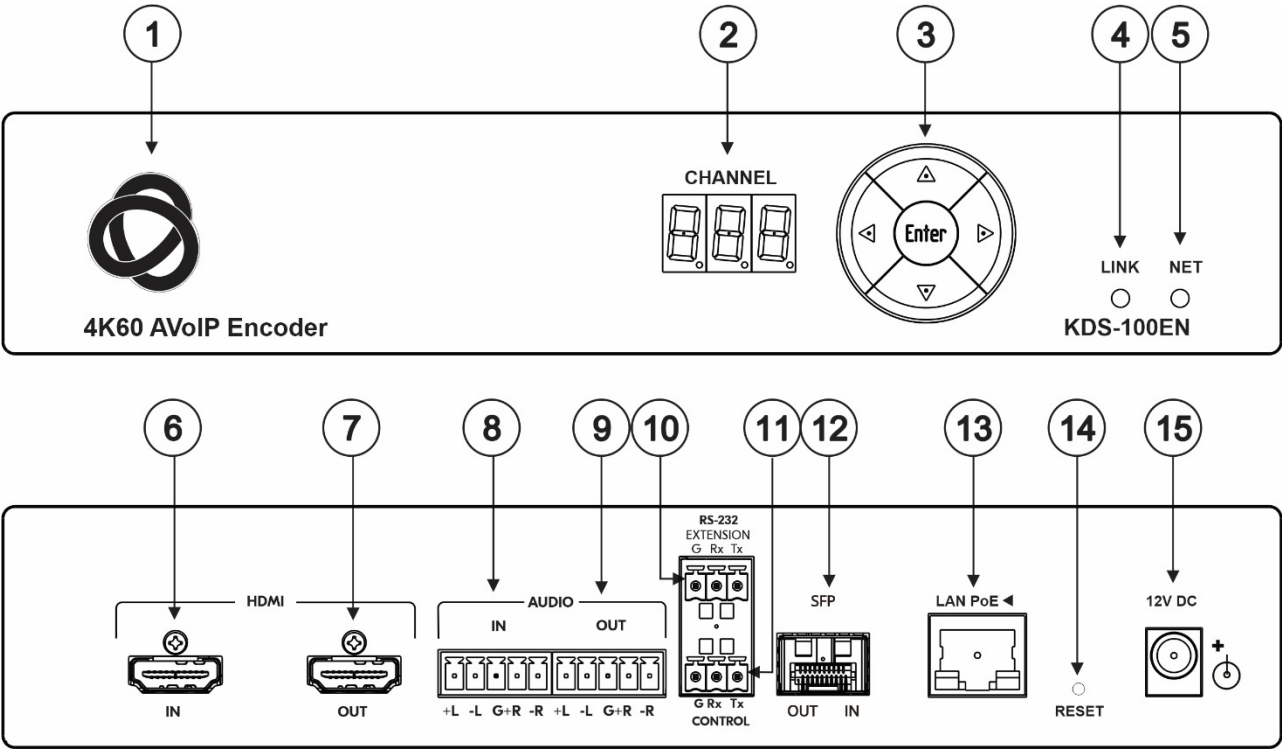

Figure 1: KDS-100EN

#	Feature	Function	
1	ON LED (behind the logo)	On when power is supplied to the unit by PoE+ or by the (optional) power adapter.	
2	CHANNEL 7-segment display	Use to set the stream's channel (channels must match on encoder and decoder).	
3	Channel Selection Button	Up	Press to increment the channel ID number by 1.
		Down	Press to decrement the channel ID number by 1.
		Right	Press to increment the channel ID number by steps of 10.
		Left	Press to decrement the channel ID number by steps of 10.
		Enter	Press to accept the new channel ID number (within 10 seconds).
4	LINK LED	Off	No HDMI input is detected, or AV streaming mode is OFF for KDS-100EN .
		Lights green	KDS-100EN is linked to a decoder and streaming is active.
		Lights blue	KDS-100EN is in Dual Streaming mode, but one of the streams is not active.
		Lights red	Streaming is not active (in Dual Streaming mode, both streams are inactive).
5	NET LED	Flashes green	A device identification command was sent (Flag me). Flashes for 60 seconds.
		Off	No network connection detected.
		Lights green	A network has been detected and KDS-100EN has a valid IP address
		Lights red	A network has been detected but the device was not assigned a valid IP address (configure with an RS-232 interface).
6	HDMI IN connector	Connect to an HDMI source.	
	HDMI OUT connector	Connect to an HDMI acceptor.	
8	AUDIO IN 5-pin terminal block	Connect to a balanced, stereo audio source (for example, from the server).	

#	Feature	Function
9	AUDIO OUT 5-pin terminal block	Connect to a balanced, stereo audio acceptor (for example, active speakers).
10	RS-232 EXTENSION 3-pin terminal block connector	Connect to a serial data source or acceptor to extend RS-232 control from KDS-100EN to a KDS-100DEC .
11	RS-232 CONTROL 3-pin terminal block connector	Connect to a serial controller or PC and use it to control KDS-100EN with P3000 API commands.
12	SFP OUT IN transceiver connector	Insert an SFP transceiver (optical SM/MM or copper) and plug in an optical / CAT-6e cable for Ethernet traffic over IP.
13	LAN PoE ◀ RJ-45 Port	Connect to the LAN (Ethernet traffic or PC controller). KDS-100EN is powered by PoE+ (power over ethernet) delivered through the LAN PoE port, unless the optional 12V DC power adapter is attached.
14	RESET recessed button	Press and hold for 10 seconds to restore factory default values. All LEDs flash.
15	12V DC connector	Connect to the optional power adapter (purchased separately).

Defining KDS-100DEC

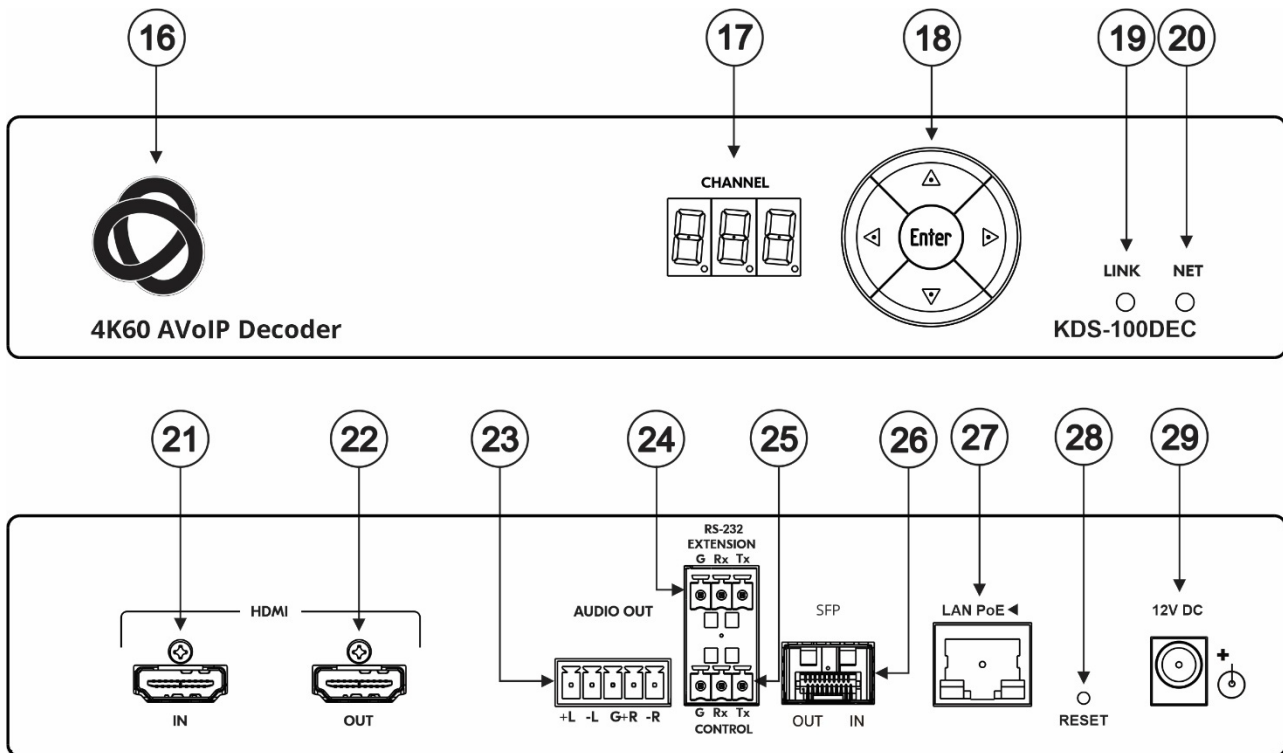

Figure 2: KDS-100DEC 4K60 AVoIP Decoder

#	Feature	Function	
16	ON LED (behind the logo)	On when power is supplied to the unit by PoE+ or by the (optional) power adapter.	
17	CHANNEL 7-segment display	Use to set the stream's channel (channels must match on encoder and decoder).	
18	Channel Selection Button	Up	Scroll up through the list of automatically discovered channels.
		Down	Scroll down through the list of automatically discovered channels.
		Right	No action.
		Left	No action.
		Enter	Press to accept the new channel ID number (within 10 seconds).
19	LINK LED	Off	No network streaming detected, or AV streaming mode is OFF for KDS-100DEC
		Lights green	KDS-100DEC is receiving an input stream and decoding is successful.
		Lights red	KDS-100DEC is receiving an input stream but decoding has failed.
		Flashes green	A device identification command was sent (Flag me). Flashes for 60 seconds.
20	NET LED	Off	No network connection detected.
		Lights green	Network detected and the device has been assigned a valid IP address
		Lights red	A network has been detected but the device was not assigned a valid IP address (configure with an RS-232 interface).
		Flashes green	A device identification command was sent (Flag me). Flashes for 60 seconds.
21	HDMI IN connector	Connect to an HDMI source.	
22	HDMI OUT connector	Connect to an HDMI acceptor.	
23	AUDIO OUT 5-pin terminal block	Connect to a balanced, stereo audio acceptor (for example, active speakers).	
24	RS-232 EXTENSION 3-pin terminal block connector	Connect to a serial data source or acceptor to extend RS-232 control from KDS-100DEC to KDS-100-EN .	
25	RS-232 CONTROL 3-pin terminal block connector	Connect to a serial controller or PC to control KDS-100DEC .	

#	Feature	Function
26	SFP OUT IN transceiver connector	Insert an SFP transceiver (optical SM/MM or copper) and plug in an optical / CAT-5e cable for Ethernet traffic over IP.
27	LAN PoE ◀ RJ-45 Port	Connect to the LAN (Ethernet traffic or PC controller). KDS-100DEC is powered by PoE+ (power over ethernet) delivered through the LAN PoE+ port, unless the optional 12V DC power adapter is attached.
28	RESET recessed button	Press and hold for 10 seconds to restore factory default values. All LEDs flash.
29	12V DC connector	Connect to the power adapter (purchased separately).

Mounting KDS-100

This section provides instructions for mounting the devices. Before installing, verify that the environment is within the recommended range:



- Operation temperature – 0° to 40°C (32 to 104°F).
- Storage temperature – -40° to +70°C (-40 to +158°F).
- Humidity – 10% to 90%, RHL non-condensing.



Caution:

- Mount the devices before connecting any cables or power.



Warning:

- Ensure that the environment (e.g., maximum ambient temperature & air flow) is compatible for the device.
- Avoid uneven mechanical loading.
- Appropriate consideration of equipment nameplate ratings should be used for avoiding overloading of the circuits.
- Reliable earthing of rack-mounted equipment should be maintained.
- Maximum mounting height for the device is 2 meters.

Mounting KDS-100 devices in a rack:

- Use the recommended rack adapter
(see https://www.kramerav.com/product/kds-100en#Tab_Application_Story or https://www.kramerav.com/product/kds-100dec#Tab_Application_Story).

Mount KDS-100 devices on a surface using one of the following methods:

- Attach the rubber feet and place the unit on a flat surface.
- Fasten a bracket (included) on each side of the unit and attach it to a flat surface.

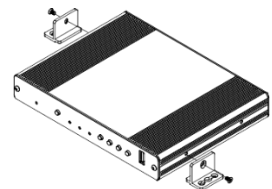

Connecting KDS-100

i By default, KDS-100 devices use PoE+ for power. An optional power adapter can be purchased separately to connect the product to the mains electricity.

Always switch off the power to a device before connecting it to your **KDS-100** device.

Connecting KDS-100EN to KDS-100DEC

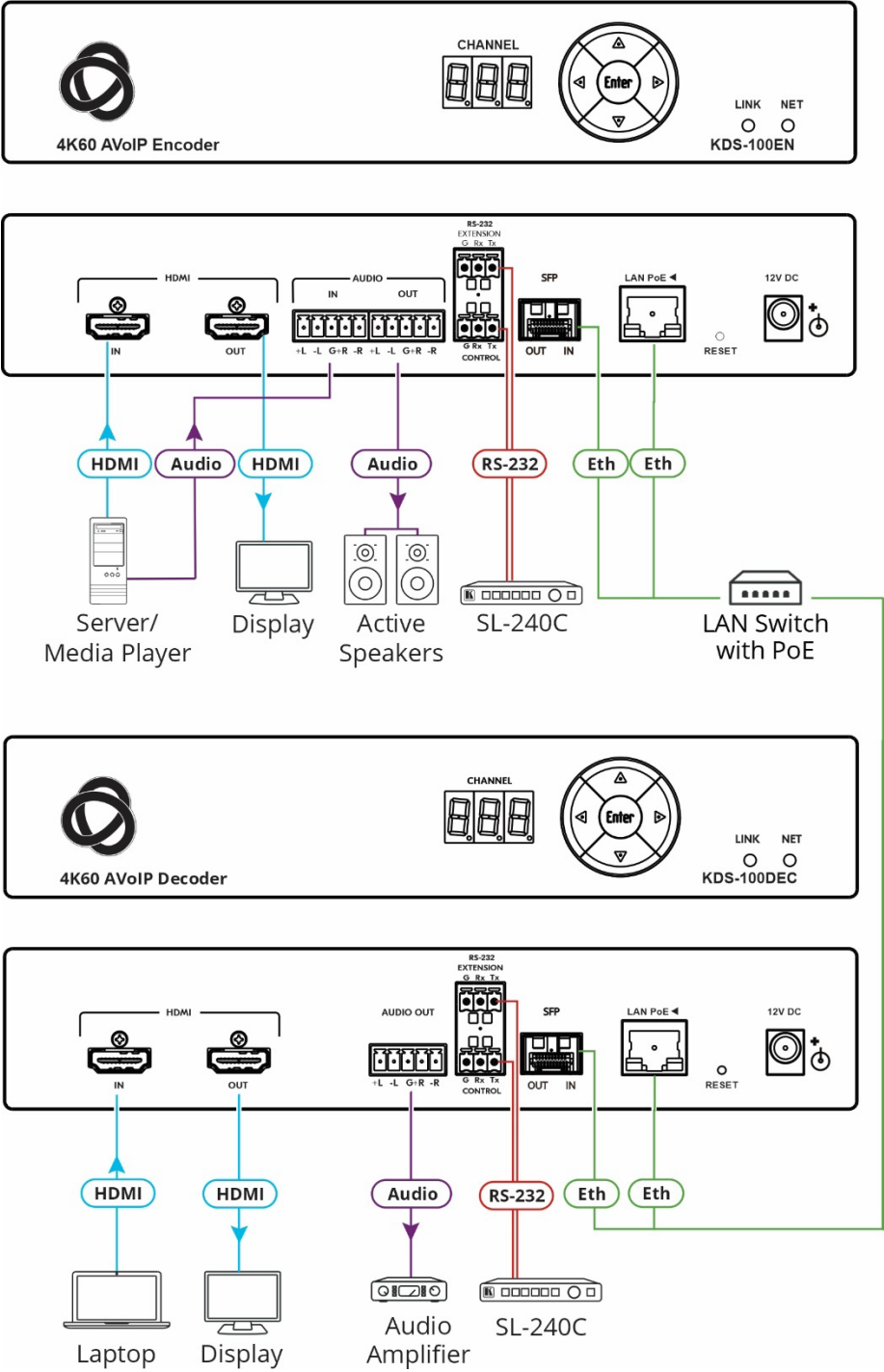

Figure 3: Connecting KDS-100EN to KDS-100DEC

To connect KDS-100EN and KDS-100DEC as illustrated in the example [Figure 3](#):

1. Connect an HDMI source (for example, a server or a media player) to the encoder's HDMI IN connector (6) (see [Defining the KDS-100](#) on page 7).
2. Connect a balanced stereo audio source (for example, the server audio connector) to the encoder's AUDIO IN/OUT 5-pin terminal block connector (8) (see [Defining the KDS-100](#) on page 7).
3. Connect the LAN MEDIA 1G(PoE) RJ-45 port (13) on the encoder to a LAN switch.
4. Connect the LAN MEDIA 1G(PoE) RJ-45 port (27) on the decoder to the same LAN switch.
5. Connect the HDMI OUT connector (22) on the **KDS-100DEC** to an HDMI acceptor (for example, a display).
6. Connect the AUDIO OUT 5-pin terminal block connector (23) on the **KDS-100DEC** to a balanced stereo audio acceptor (for example, an audio amplifier).
7. Connect RS-232 3-pin terminal block connectors:
 - On the **KDS-100EN**, connect the RS-232 port (10) to a control device such as the SL-240C.
 - On the **KDS-100DEC**, connect RS-232 (24) to a device that can be controlled by RS-232.



RS-232 bidirectional signals can be sent between the encoder and decoder.

Connecting RS-232

KDS-100 devices feature an RS-232 3-pin terminal block connector (11) on their rear panel which can be used to transmit RS-232 data between the encoder and decoder and to remotely control connected devices.

Connect the RS-232 terminal block on the rear panel to a PC/controller, as follows:

From the RS-232 9-pin D-sub serial port connect:

- Pin 2 to the TX pin on the RS-232 terminal block
- Pin 3 to the RX pin on the RS-232 terminal block
- Pin 5 to the G pin on the RS-232 terminal block

RS-232 Device

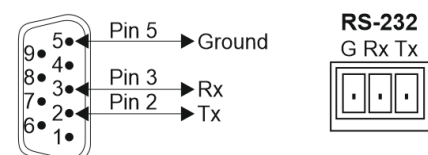

Connecting the Audio/Input Output

The following are the pinouts for connecting the input/output to a balanced or unbalanced stereo audio acceptor:

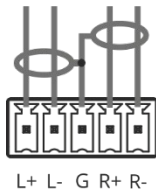

Figure 4: Connecting to a Balanced Stereo Audio Source/Acceptor

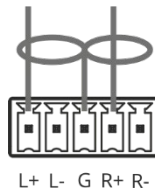

Figure 5: Connecting to an Unbalanced Stereo Audio Acceptor

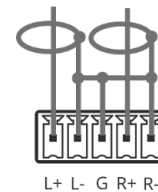

Figure 6: Connecting an Unbalanced Stereo Audio Source to the Balanced Input

Installing the SFP transceiver (optical SM/MM or copper)

1. Remove the currently installed transceiver: Pull down the bale clasp, insert the dust plug and pull out. Store in a safe place.
2. Make sure the bale clasp of the new transceiver is pushed up, in the closed position.
3. Insert the new transceiver into the SFP port and push it in until it clicks.
4. Remove the dust plug and store it in a safe place for future use.

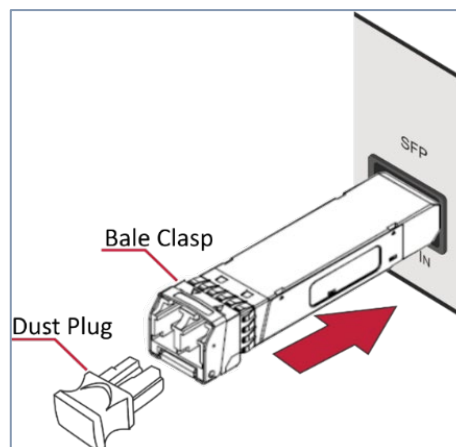

Figure 7: Inserting the SFP transceiver



Warning:

- Connecting the SFP transceiver to an LC(APC) fiber connector may cause poor performance and damage the connector!



Warning: Class 1 Laser Product

- Invisible laser radiation present.
- Avoid long-term viewing of laser.
- Avoid the use of magnifying viewing aids or instruments (such as binoculars, telescopes, microscopes, and magnifying lenses, but not spectacles or contact lenses).
- Avoid placing optical devices in the emitted beam that could cause the concentration of the laser radiation to be increased.

Operating and Controlling KDS-100 Devices

This section describes the following actions:

- [Configuring the Network Switch](#) on page 15.
- [Using the Channel Selection Buttons](#) on page 15.
- [Operating via Ethernet](#) on page 16.

Configuring the Network Switch

Make sure that your AV over IP network switch meets the following minimum requirements:

- IGMP Snooping – On.
- IGMP Immediate/Fast Leave – On.
- Unregistered Multicast Filtering – On.
- PoE+ (unless using the optional power supply)

Using the Channel Selection Buttons

Each encoder requires a unique channel number. Decoders connected to the encoder must be tuned to the same channel as the encoder. You can set the channel number with the Channel Selection button (shown in the image) or the embedded web pages.

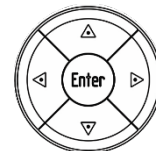

Setting the channel number with the channel selection button:

1. For the **KDS-100EN**:
 - a) Use the UP/DOWN arrows to increment/decrement the channel number by 1 and the RIGHT/LEFT buttons to increment/decrement by 10. Channel selections that collide with an existing channel will not be accepted.
 - b) Press **ENTER** (while the CHANNEL display flashes) to accept the changes.
 - Channel selections that collide with an existing channel will not be accepted.
 - The CHANNEL display flashes for 10 seconds and the new channel ID is displayed.
 - If ENTER is not pressed within the 10-second flashing period, or if an error occurs, the channel ID is not changed.
2. On each connected **KDS-100DEC**:
 - Set the same channel number defined on the **KDS-100EN**: Use the UP/DOWN arrows to scroll up or down through the list of automatically detected channels.
 - If **Dual Stream** mode is activated on **KDS-100EN**, both output streams have the same Channel ID.
 - The CHANNEL display flashes for 10 seconds, press Enter while it flashes to confirm the selection.

Operating via Ethernet

This section describes the following actions:

- [Accessing the embedded web pages](#) on page 16.
- [Connecting the Ethernet Port Directly to a PC](#) on page 17.
- [Connecting Ethernet Port via a Network Hub or Switch](#) on page 18.
- [Configuring Ethernet Port](#) on page 18.

Accessing the embedded web pages

Each KDS-100 device contains an embedded HTML menu which provides extensive device controls. The embedded web pages are accessed by entering the IP of the KDS-100 device in a browser within the same network or on a computer directly connected to the KDS-100 device.

To access the embedded web pages, perform the following:

1. Connect the LAN port of the KDS-100 device to a local area network.
2. By default, DHCP sets the IP of your KDS-100 device and you may need to ask your network administrator to identify its IP address.
If no DHCP server is available, for example if the device is connected directly to a PC, it will use the default IP addresses (192.168.1.39 for the encoder and 192.168.1.40 for the decoder).
3. Connect your PC to the same network as the encoder / decoder.
4. Input the encoder or decoder's IP address in the browser and press Enter, if Security is enabled (default), the Login window pops up.

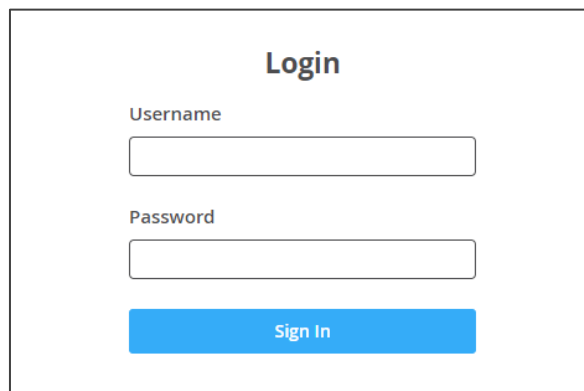

The image shows a web browser window titled "Login". It contains two input fields: "Username" and "Password". Below these fields is a blue button labeled "Sign In".

Figure 8: Login Window

4. Input the username and password (default username / password: Admin / Admin) and click **Sign In** to enter the main page of embedded web pages.

You have accessed the embedded web pages.

Connecting the Ethernet Port Directly to a PC

You can connect the encoder/decoder Ethernet port directly to the Ethernet port on your PC using a crossover Ethernet cable with RJ-45 connectors.



This type of connection causes **KDS-100EN** and **KDS-100DEC** to use their factory configured default IP address.

After connecting the KDS-100 device to the PC's Ethernet port, configure your PC as follows:

1. Click **Start > Settings > Network and Internet**.
2. Click **Change Adapter Options**.
3. Highlight the network adapter you want to use to connect to the device and click **Change settings of this connection**. The Local Area Connection Properties window for the selected network adapter appears as shown in [Figure 9](#).
4. Highlight either **Internet Protocol Version 6 (TCP/IPv6)** or **Internet Protocol Version 4 (TCP/IPv4)** depending on the requirements of your IT system.

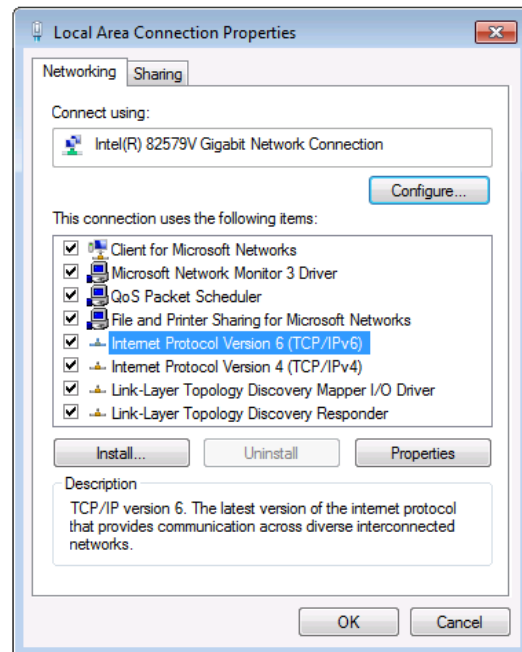

Figure 9: Local Area Connection Properties Window

5. Click **Properties**. The Internet Protocol Properties window relevant to your IT system appears as shown in [Figure 10](#) or [Figure 11](#).

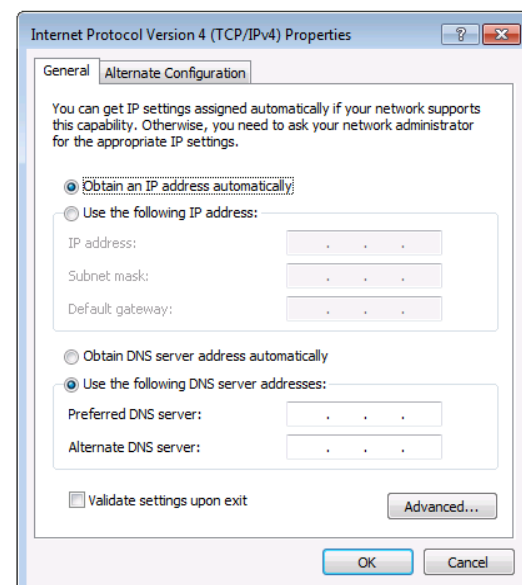

Figure 10: Internet Protocol Version 4 Properties Window

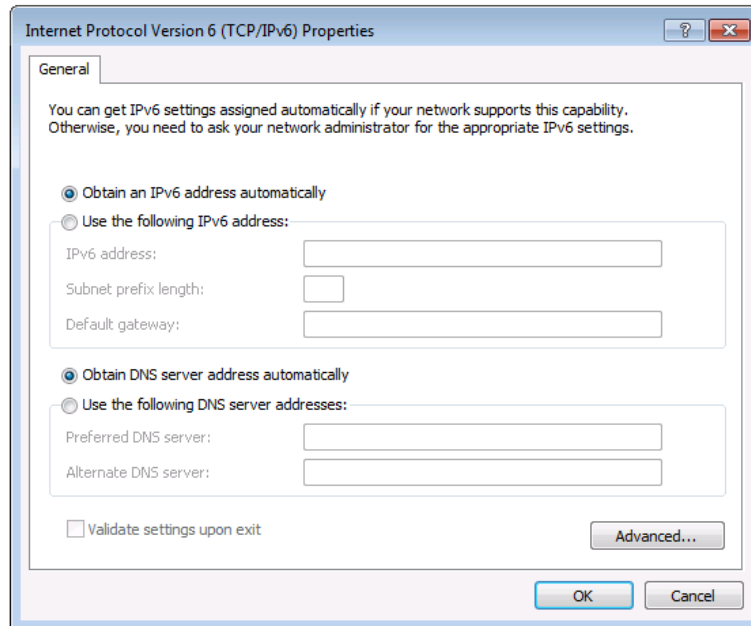

Figure 11: Internet Protocol Version 6 Properties Window

6. Select **Use the following IP Address** for static IP addressing and fill in the details as shown in [Figure 12](#).

For TCP/IPv4 you can use any IP address in the range 192.168.1.1 to 192.168.1.255 (excluding 192.168.1.39) that is provided by your IT department.

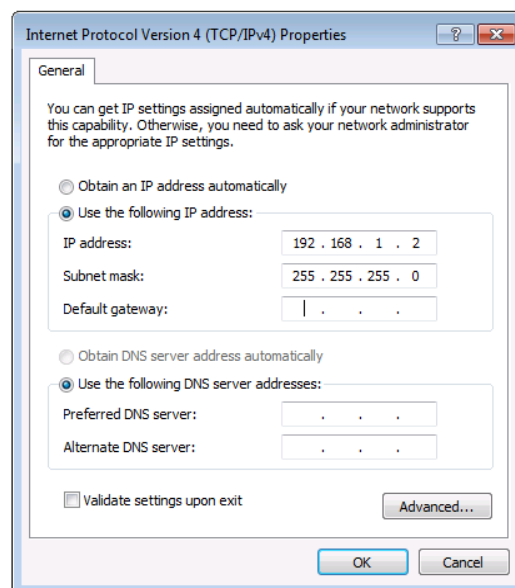

Figure 12: Internet Protocol Properties Window

7. Click **OK** and then click **Close**.

Connecting Ethernet Port via a Network Hub or Switch

You can connect the KDS-100 Ethernet port to the Ethernet port on a network hub or using a straight-through cable with RJ-45 connectors.

Configuring Ethernet Port

Ethernet parameters are best set using the embedded web pages. P3000 API commands can also be used.

KDS-100EN: Using the Embedded Web Pages

KDS-100EN enables you to configure settings using the built-in, user-friendly, Ethernet web pages. The web pages are accessed using a web browser and an Ethernet connection.

 For the decoder web pages, see [KDS-100DEC: Using the Embedded Web Pages](#) on page 33.

KDS-100EN can also be configured by Protocol 3000 commands (see [Protocol 3000 Commands](#) on page 53).

For instructions on how to connect to the encoder and load the web pages, see [Operating via Ethernet](#) on page 16.

 If a web page does not update correctly, clear the browser cache.
Some features may not be supported by mobile device operating systems.

To Browse the KDS-100EN Web Pages:

1. Open your Internet browser.
2. Type the IP number of the device in the address bar of your browser. For example, the default IP number:



If Security is enabled in the Security page, then the Login window appears.

Figure 13: Login Window

3. Enter the Username and Password (default Admin / Admin).

The **KDS-100EN** page appears.

4. Click the tabs on the left to select a relevant web page.

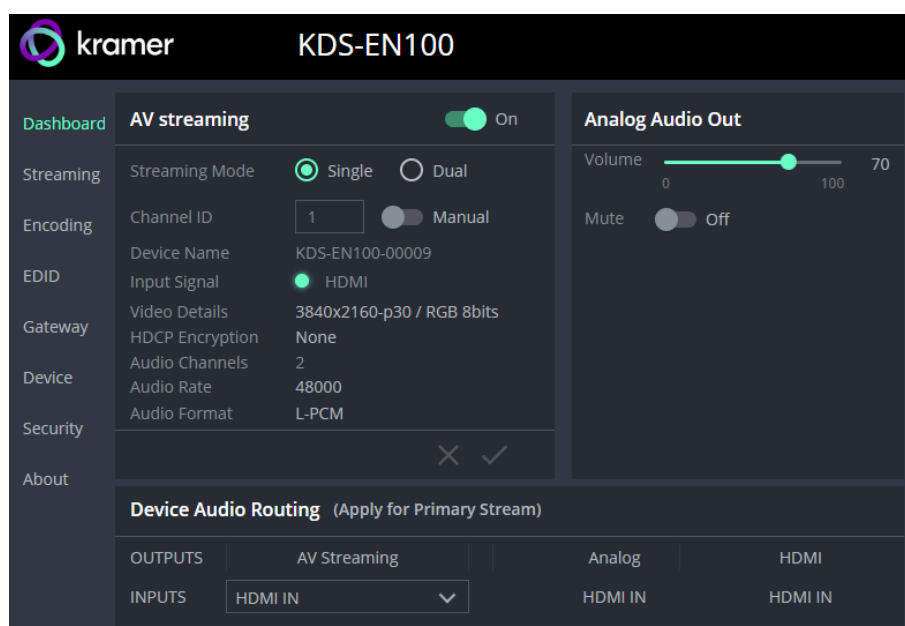

Figure 14: Dashboard Window

Dashboard: *Set channel and audio, view input signal*

The **KDS-100EN** Dashboard shows an overview of AV streaming and audio information. Use the dashboard to set the streaming channel, mode and audio parameters.

To set the streaming channel:

1. In the **Dashboard** pane, activate AV Streaming.
2. Define the following settings:
 - **Streaming Mode: Dual** outputs the stream twice, with the second stream at a lower bandwidth and higher latency. Additional options are set in the **Streaming** pane and the **Encoding** pane.
 - **Channel ID:** Enter a channel in **Manual** mode or move the slider to **Automatic** and the device will select the first unused channel. The channel ID (1 to 899) must be identical on encoder and decoder.
 - Additional fields are displayed to describe the input AV.
3. Click the green check to confirm your changes.

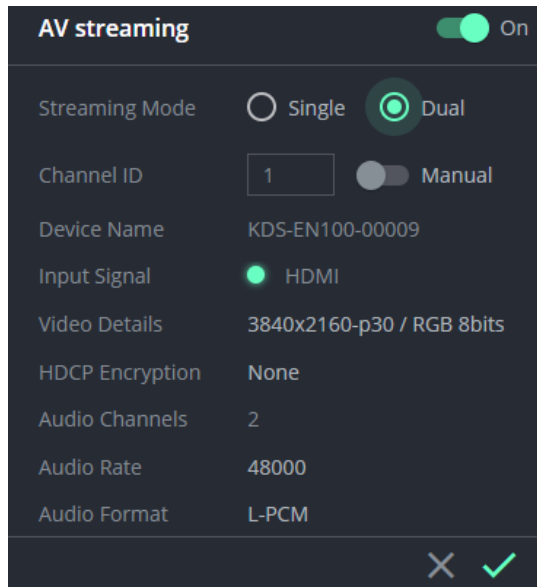

To set the audio volume:

- **Volume:** Use the slider to adjust the analog audio output volume (0 to 100%). Default is 70%. 100% is 12dB and 0% is mute.
- **Mute:** Mute/unmute all audio outputs (HDMI OUT, AUDIO OUT, and MEDIA ports).

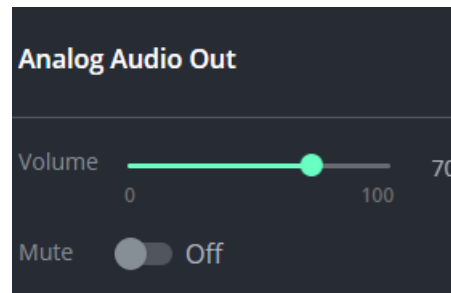

To set the audio output's source:

- In the INPUTS dropdown, select from HDMI IN, Analog Audio Input and None.

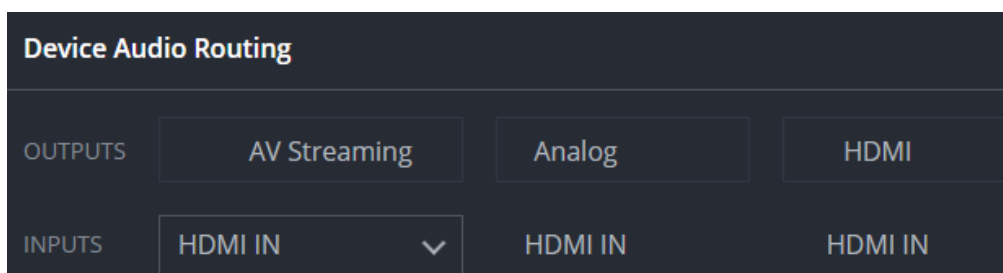

Streaming: *Multicast settings and time to live*

Multicast communication transmits the data stream to multiple receivers simultaneously, forming a multicast group.

STREAM 2 is only active if you selected **Dual** streaming in the **Dashboard** pane.

- **Multicast Prefix** – Select a prefix for the multicast stream's IP between 224 and 239 and click Save (prefix as in **224.x.x.x**). Routers identify multicast streams by the IP address to which the stream is directed. IP prefixes can be used to identify the stream's packets as data which is not directed to a specific recipient, but a general stream addressed to the entire network.
- **Multicast ports** (non-editable) can be used to make it easier for routers, servers and clients to separate and handle the stream data.
- **Time To Live** (TTL) restricts the number of times a packet/data can be forwarded by network routers before it is discarded. It stops the stream data from circulating endlessly in the network. Select a value between 1 and 255 (and click Save).
- **Bandwidth** is the maximum amount of multicast bandwidth that a single multicast stream can use. It is set in **Encoding > Advanced preferences**.



Network configurations need to be properly set up to enable multicast communication.

Click **Save** after setting a **Multicast Prefix** or **Time to Live** limit.

	STREAM 1	STREAM 2
Multicast Prefix 	<input type="text" value="239"/>	<input type="text" value="239"/>
Multicast Address	239.2.16.1	239.3.16.1
Multicast Video Port	5007	5007
Multicast Audio Port	5011	5011
Time To Live	<input type="text" value="3"/>	<input type="text" value="1"/>
Bandwidth (Bitrate)	15000 Mb/s	25000 Mb/s
	<input type="button" value="CANCEL"/>	<input type="button" value="SAVE"/>

Figure 15: The Streaming pane

Encoding: *Method, protocol, scaling, bitrate and more*

Video encoding is the process of compressing the video data so it can be efficiently sent to another location with as little latency (delay) as possible without compromising quality.

Note that **STREAM 2** is only active if you selected **Dual** streaming in the **Dashboard** pane. Stream 2 is intended for a lower bandwidth version of Stream 1 and has more limited options.

	STREAM 1	STREAM 2
Encoding method	HEVC (H.265) Low La...	HEVC (H.265)
Protocol	RTP	RTP
Scaling	1920x1080-p60	1920x1080-p30
Rate control	Constant	Constant
Advanced preferences		
Bitrate	15000 Kb	25000 Kb
GOP size	50	10
B frames	0	0
Slices per frame	8	5
IDR frequency	3600	240

Figure 16: Encoding panel

To define the encoding method, protocol and scaling:

1. In the **Encoding** pane, select the **Encoding method** from **H.264**, **HEVC (H.265)** and **HEVC (H.265) Low Latency**.

Impact of the encoding method on the advanced preferences:

Parameters	Normal Mode (H264, HEVC[H265])		Low Latency Mode (HEVC [H.265])	
	Stream 1	Stream 2	Stream 1	Stream 2
Bitrate	15000	5000	15000	-
GOP size	10	10	50	-
B frames	0	0	0	-
Slices per frame	4	4	8	-
IDR frequency	240	240	3600	-

2. Select the **Protocol** used to transfer the video over the network.
3. Select the **Scaling** from **Passthrough**, **3840x2160-p60**, **3840x2160-p30** and **1920x1080-p60**. P30 / P60 = frames per second, 3840 x 2160 = 4K resolution, 1920x1080 = 1080p. Higher resolution images require appropriate cables.
4. If necessary, make changes to the advanced settings (field descriptions below).
5. Click **Save**.

Advanced preferences:

- **Bitrate** – From 1 to 60Mbps. Higher bitrates produce higher quality images but require more data and bandwidth.
- **GOP size** – Sizes are from 1 to 1,000. GOP (group of pictures) encoded streams group pictures together and then transmit the differences. The GOP size is the gap between every transmitted full picture.
- **B frames** – From 0 to 4. Bidirectional predicted pictures save space by using differences between the current frame and both the preceding and following frames to build pictures.
- **Slices per frame** – From 1 to 22 (32 on STREAM 2). To speed up video encoding each frame can be divided into sections (slices) which are encoded in parallel.
- **IDR frequency** – Minimum (-1). IDR (instantaneous decoder refresh) frames are frames that clear all saved reference frames.

EDID: *Set display metadata*

Extended Display Identification Data (EDID) contains metadata describing HDMI display device formatting and capabilities so that the output can be adjusted to match the display's requirements. EDIDs can be retrieved from the display, or a preset EDID can be used.

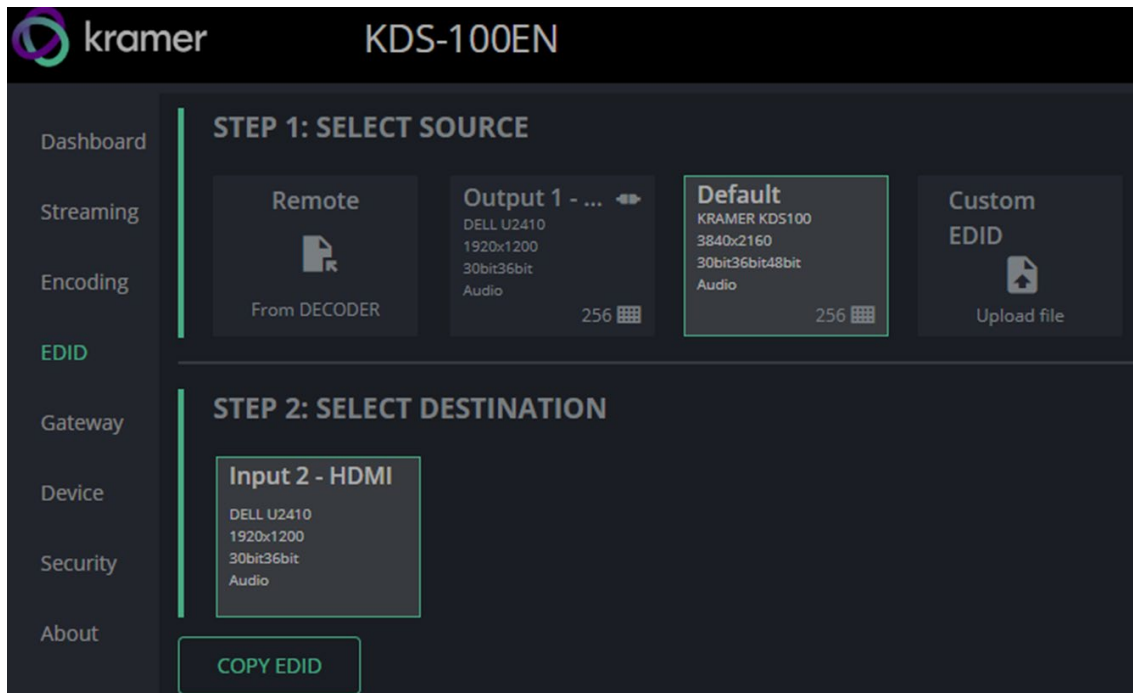

Figure 17: EDID pane

Step 1: Select Source.

To select the EDID, click on a **Select Source** square and then click **COPY EDID** at the bottom; The selected EDID will be copied to **Select Destination**.

Select Source options:

- **Remote, from decoder** – Click this option to open a pop-up for entry of the desired decoder's IP address. The EDID of the screen connected to the HDMI Out port of the selected decoder will be returned to the device.
- **Output 1** - Shows the last/current EDID used by the encoder. Select the **Output 1** square to use this EDID. Click the bottom right corner **256** to view the EDID bitmap.
- **Default** – A default EDID is supplied with the **KDS-100EN**. Click the bottom right corner **256** to view the EDID bitmap.
- **Custom EDID** - Upload a stored EDID file from your computer.

Step 2: Select Destination

Click **COPY EDID** and your selected EDID will be loaded into the destination square.

EDID is managed.

Gateway: *RS-232 settings*

To set the RS-232 Gateway:

1. In the **Gateway** pane, move the **RS-232 Gateway** slider to the right.
2. Enter the **Baud Rate** 50 to 921,600 (default is 9,600).
3. Enter the **Data Bits**: 5, 6, 7 or 8 (default).
4. Enter **Parity**: None (default), Odd, Even, Mark or Space.
5. Enter **Stop Bits**: 1 (default) or 2.
6. Click **SAVE**.

RS-232 Gateway is configured.

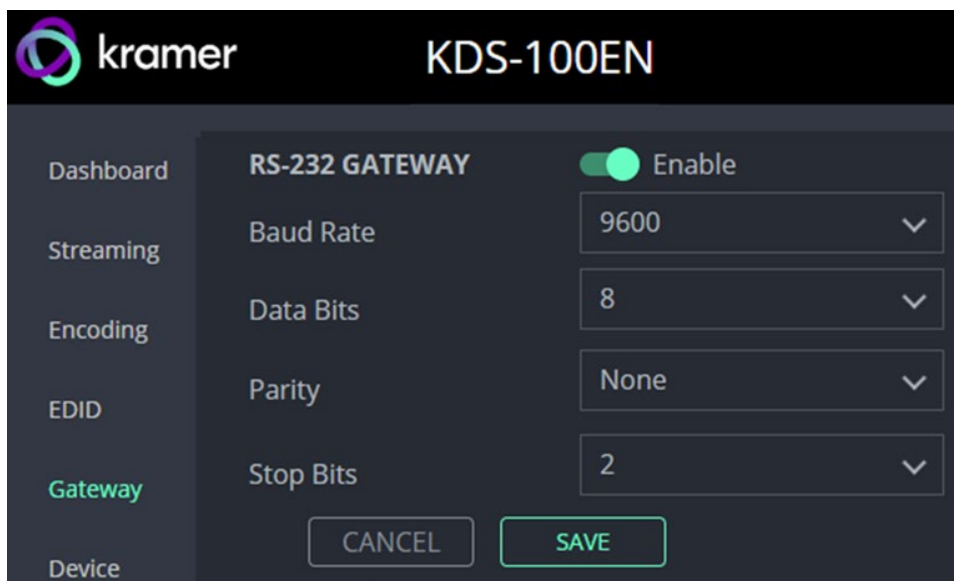

Figure 18: Gateway pane

Device: *General device, network and time settings*

The KDS-100EN **Device** pane has three tabs:

- **General** – Sets the channel name, update firmware and reset or locate the device.
- **Network** – Set the LAN and port parameters for the device.
- **Date & Time** – Define an NTP (network time protocol) server or set the time. An NTP server is advisable, as it coordinates the time between all the connected devices.

General tab

	General	Network	Date & Time
Device Name	KDS-EN100-0000		
Model	KDS-EN100		
Serial Number	3230019400009		
Firmware Version	01.03.64532		Update
	DEVICE RESTART		FLAG ME
	FACTORY RESET		
	CANCEL	SAVE	

Figure 19: Device pane – General tab

- **Device name** – Edit or view the device's Host name.
- **Model and Serial Number** of the encoder.
- **Firmware Version** – To update the encoder firmware, download the latest version from <https://www.kramerav.com/downloads/kds-100en> to a local network location and then click **Update** to select and upload it.
- **Device Restart** – Click to restart **KDS-100EN** (confirmation will be requested).
- **Factory Reset** - Click to reset the device's operation mode and restart the device (confirmation is requested).
- **Flag Me** – The LEDs will flash fast for 10 seconds to identify the device.

Network tab

Use the **KDS-100EN Device** pane's Network tab to enable DHCP or, if you prefer, to define a static IP address for the **KDS-100EN**.

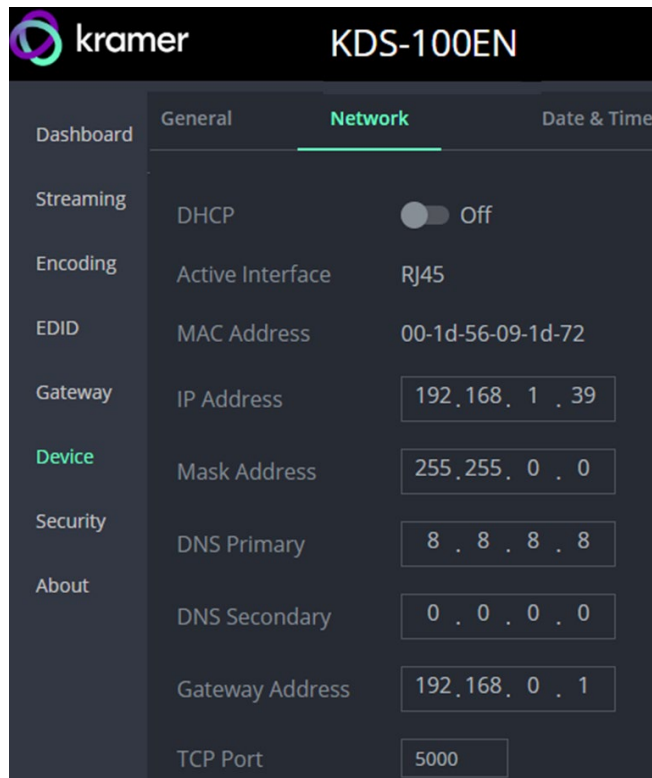

Figure 20: Device pane – Network tab

- **DHCP** – Set the slider to On, to have your DHCP server automatically define an IP address.
- **Active Interface** – the current active output.
- **MAC Address** – MAC of the **KDS-100EN**.
- Static IP definition fields: **IP Address**, **Mask Address**, **DNS (primary and secondary)** and **Gateway Address**. Not relevant if DHCP is enabled.
- **TCP Port** (default is 5000).

Date & Time tab

An NTP (Network Time Protocol) server should be used for KDS-100 series deployments. The NTP is essential for encoder and decoder synchronization, time stamping, and reliability in applications where coordination is critical. It helps prevent drift, jitter, out-of-sync data and contributes to reliable and efficient system operation.

Note: If no NTP server is available, it is possible to enter the address of a KDS-100 device (encoder or decoder), and the device will synchronize time to that device.

To sync device time and date from a network time server:

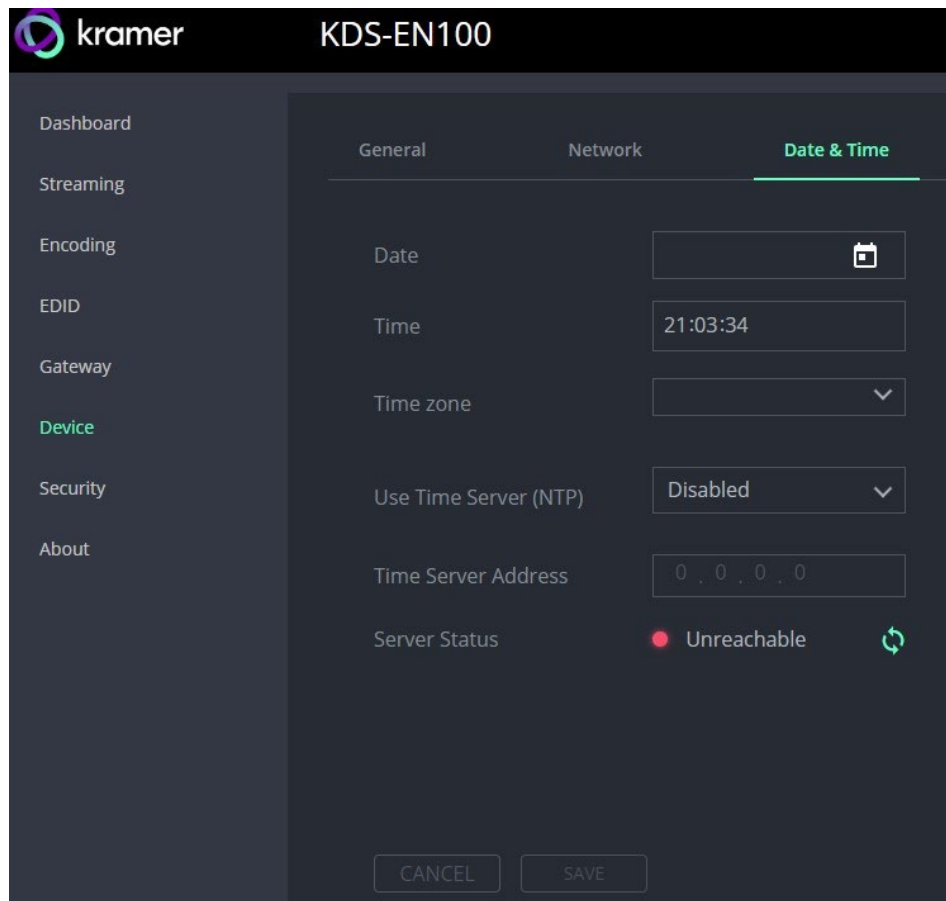



Figure 21: Device Pane – Date & Time tab

1. In the **Device** pane, select the **Date & Time** tab.
2. Set the **Time zone**.
3. Set **Use Time Server (NTP)**, to On.
4. Enter the **Time Server Address** IP (or the IP of a KDS-100 Series device that you are using as an alternative to a Time Server).
5. Click **SAVE**.

The devices date and time are synchronized to the server address entered.

Security: *Passwords, HTTPS and 802.1X*

-  Password protection is only active when the **Security Status** is On (default).
The default password is (username) Admin, (password) Admin.

The **KDS-100EN** Security tab has three tabs:

- **Security** – Enable/disable security and change the device password.
- **HTTPS** – Use the device's internal certificate or upload a local certificate.
- **802.1X**- Enable and setup IEEE 802.1X authentication.

Security tab

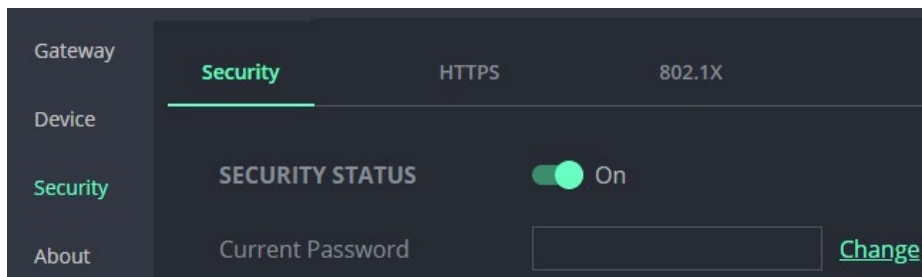

Figure 22: Security pane – Security tab

To change Security Status

Move the slider to enable/disable security. To disable security you must enter the device's current password in a pop-up.

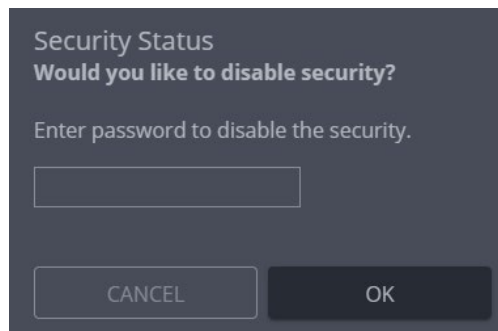

Figure 23: Security pane – pop-up

To change the password

Password protection is only available if the **Security Status** is On. To change the password, enter the **Current Password** and then click **Change**.

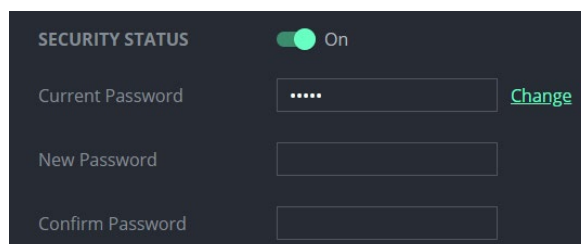



Figure 24: Security pane – Change password

HTTPS tab

To configure HTTPS:

1. In the **Security** pane's **Security** tab, **Security Status** must be enabled.
2. Select the **HTTPS** tab.
3. Select one of the following authentication methods:
 - **Internal Certificate** – Use the factory default certificate for authentication.
 - **Server Certificate** – Submit a certificate from the server for authentication (assigned by your network administrator). Click  to upload the certificate. Enter the private key password and click **APPLY & REBOOT**.

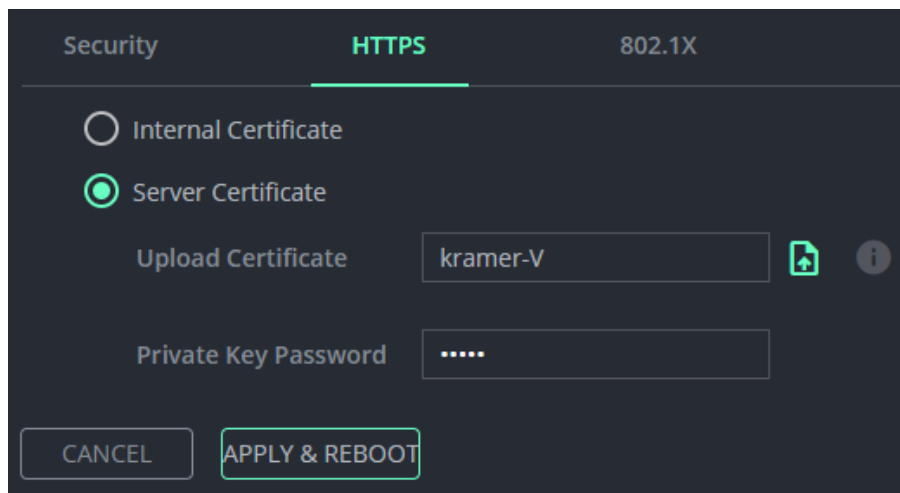



Figure 25: Security Tab – Server Certificate

4. Click **APPLY & REBOOT**.

HTTPS is configured.

802.1X tab

To configure IEEE 802.1X Authentication:

1. In the **Security** pane, select the **802.1X** tab.
2. Set 802.1x authentication **ON**.
3. Check one of the following settings:
 - **EAP-MSCHAP V2** – To use this authentication method, enter the **KDS-100EN** username and password.
 - **EAP-TLS** – Submit a certificate from your network authentication server. To do so, enter the **KDS-100EN** Username (default Admin / Admin), click  to upload the certificates and keys, and enter the private key password (assigned by your network administrator).

Set **Server Certificate** to **On**.

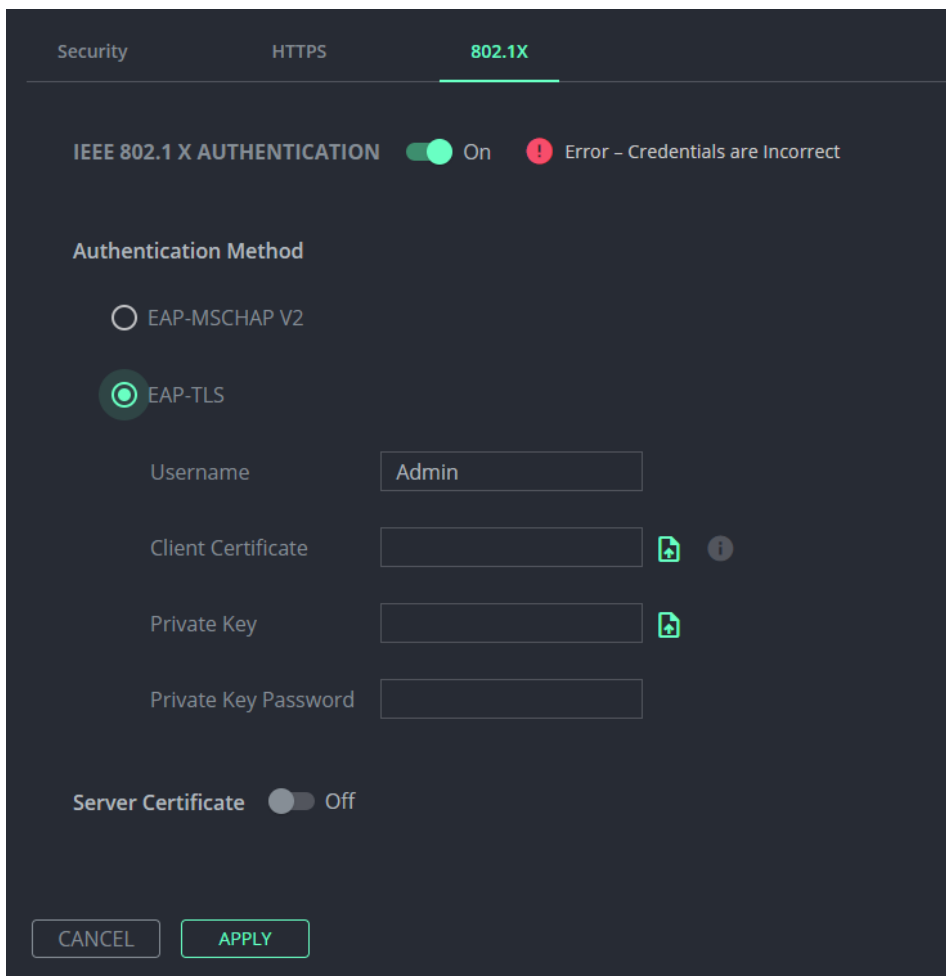

Security HTTPS **802.1X**



IEEE 802.1 X AUTHENTICATION On  Error - Credentials are Incorrect

Authentication Method

EAP-MSCHAP V2

EAP-TLS

Username

Client Certificate  

Private Key 

Private Key Password

Server Certificate Off

Figure 26: EAP-TLS – Certificates and Password

4. Click **APPLY**.

Security is configured.

About: *Web version and contact details*

View the web page release version and Kramer Electronics Ltd details.

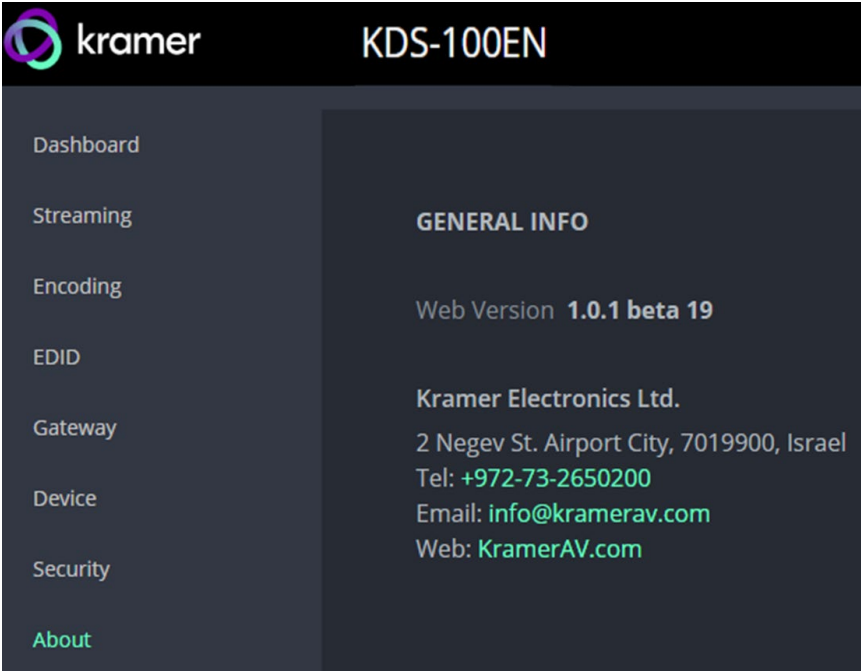



Figure 27: About Page

KDS-100DEC: Using the Embedded Web Pages

KDS-100DEC enables you to configure settings via Ethernet using built-in, user-friendly web pages. The Web pages are accessed using a Web browser and an Ethernet connection.

 You can also configure **KDS-100DEC** via Protocol 3000 commands (see [Protocol 3000 Commands](#) on page 53).

For instructions on how to connect to the decoder and load the web pages, see [Operating via Ethernet](#) on page 16.

 If a web page does not update correctly, clear your Web browser's cache.
Some features may not be supported by mobile device operating systems.

To Browse the KDS-100DEC Web Pages:

1. Open your Internet browser.
2. Type the IP number of the device in the Address bar of your browser. For example, the default IP number: 192.168.1.40.

If **Security** is enabled in the Security pane, then the Login window appears.

3. Enter the Username and Password (default Admin / Admin).

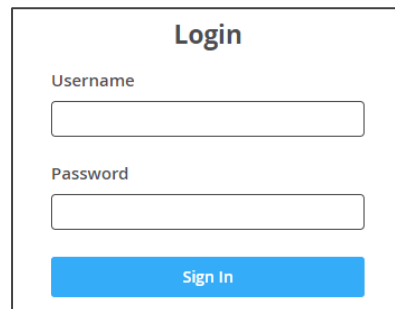

The screenshot shows a 'Login' window with two input fields: 'Username' and 'Password'. Below the fields is a blue 'Sign In' button.

Figure 28: Login Window

The **KDS-100DEC** page appears.

4. Click the tabs on the left to select a relevant web page.

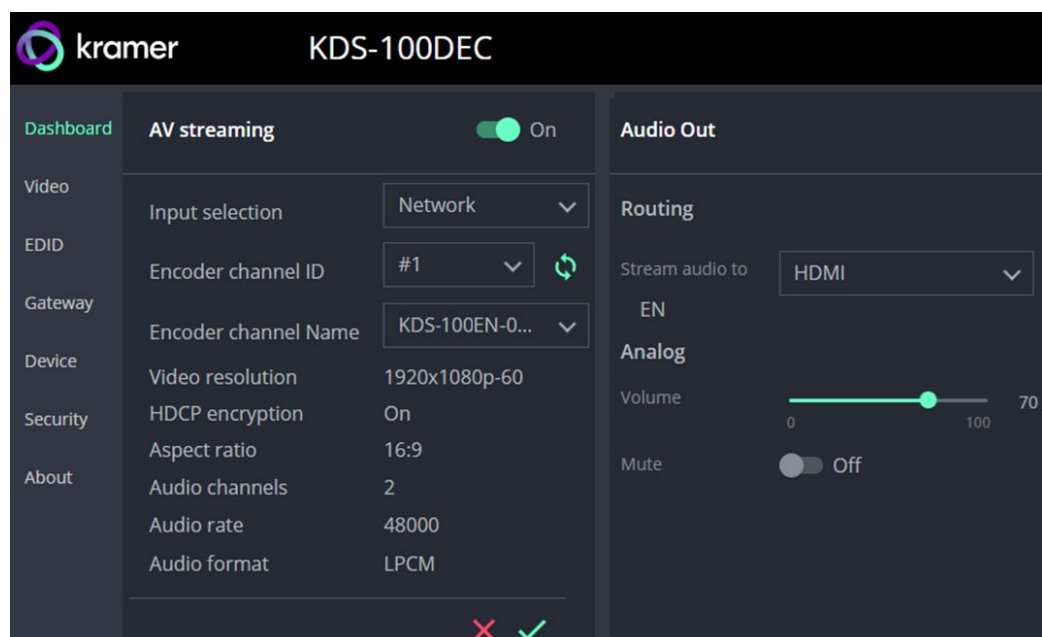

Figure 29: Dashboard Window

Dashboard: *Set channel and audio, view input signal*

The **KDS-100DEC** Dashboard shows an overview of AV streaming and Audio information. Use the dashboard to set the input source: Network stream or connected HDMI device.

To set the streaming channel:

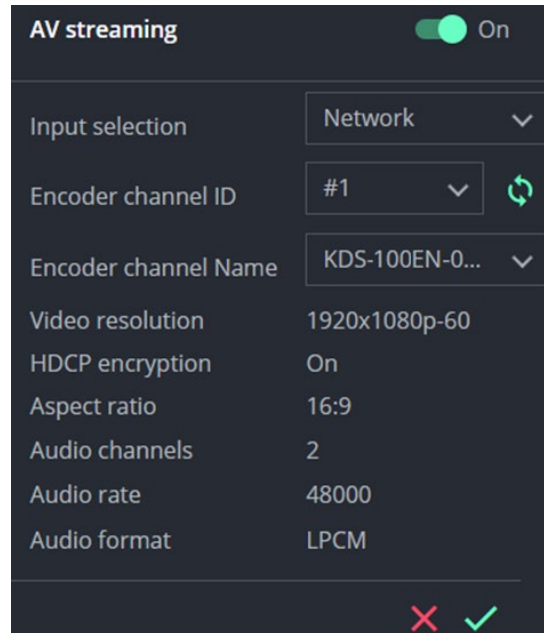



Figure 30: Dashboard Window, AV streaming fields

1. In the **Dashboard** pane, activate AV Streaming. AV Streaming is not required for HDMI input.
2. Define the following settings:
 - **Input selection:** Network or HDMI.
 - **Encoder channel ID:** The encoder channel list only shows channels that can be decoded according to the decoding method defined in the **Video** pane (see [Video: Decoding method and output resolution](#) on [page 36](#)).
 - Channel IDs in the range 1-899 are encoder channels. Set the same channel used by the encoder. If the encoder is set to Automatic, the channel will be set automatically. Click the arrows  to refresh.
 - Channel IDs in the range 900-999 are virtual channels allocated to external devices such as IP cameras (see [External Devices: Connecting External RTSP Streams](#) on [page 37](#)).
 - **Encoder channel Name:** The host name of the encoder or the name defined on devices tab for external devices.
3. Click the green check to approve any changes. 

Video resolution, HDCP encryption, Aspect ratio, Audio channels, Audio rate and **Audio format** are set by the data source.

To set the audio output:

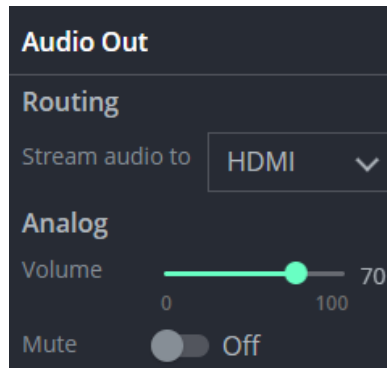

Figure 31: Dashboard Window, Audio output fields

- **Routing:** Set the destination of the audio stream, choose from HDMI, Analog, HDMI + analog or None.
- **Analog:** Use the slider to adjust the analog audio output volume (0 to 100%). Default is 70%, 100% is 12dB and 0 is mute.
- **Mute:** Mute/unmute all audio outputs (HDMI OUT, AUDIO OUT, and MEDIA ports).

Video: *Decoding method and output resolution*

Set the **KDS-100DEC** video decoding method. The decoding method must be the same as the encoding method used by **KDS-100EN**.

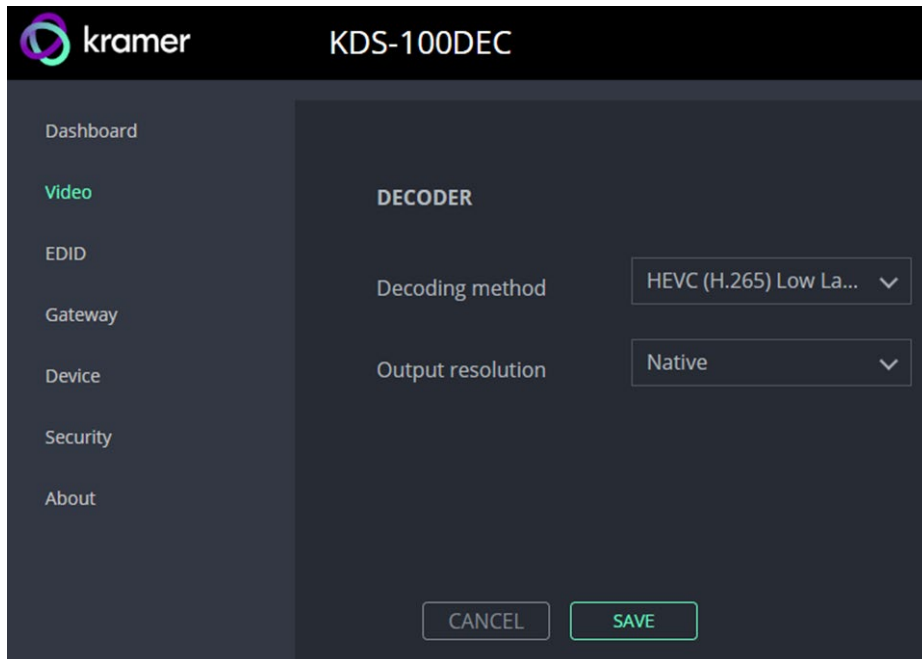

Figure 32: Dashboard Window

To define decoding and output:

1. In the **Decoding method**, select the method that was used to encode the stream from **H.264, HEVC (H.265) and HEVC (H.265) Low Latency**.
2. Select the **Output resolution**, select **Native** to match the output resolution to the connected display screen.
3. Click **Save**.

External Devices: *Connecting External RTSP Streams*

Use the **External Devices** tab to connect KDS-100DEC to devices creating RTSP streams, such as IP (live streaming) cameras.

Adding a Device

KDS-100DEC detects streams manually added to the DEVICE LIST. When a device is selected in the **Device List**, its properties can be edited in the **Device Properties**.

To add an RTSP stream to KDS-100DEC:

1. In the External Devices pane, click ADD DEVICE.

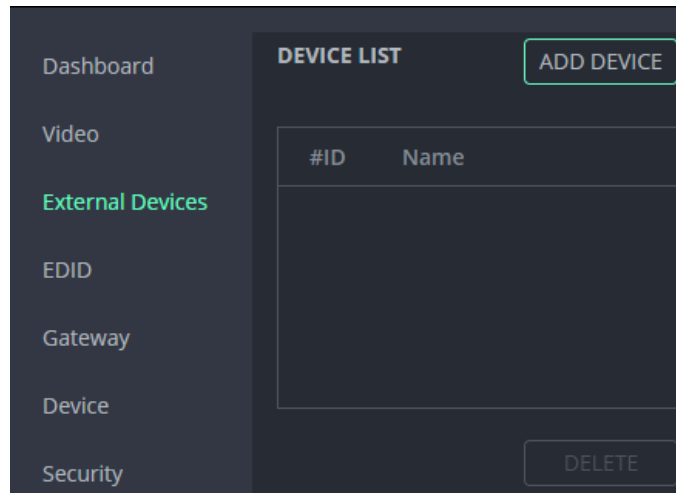

Figure 33: External Devices - Device List

2. KDS-100DEC will automatically allocate the first available Channel ID (#ID) in the range 900-999, add it to the **Device List** and open the **Device Properties** for you to enter details.

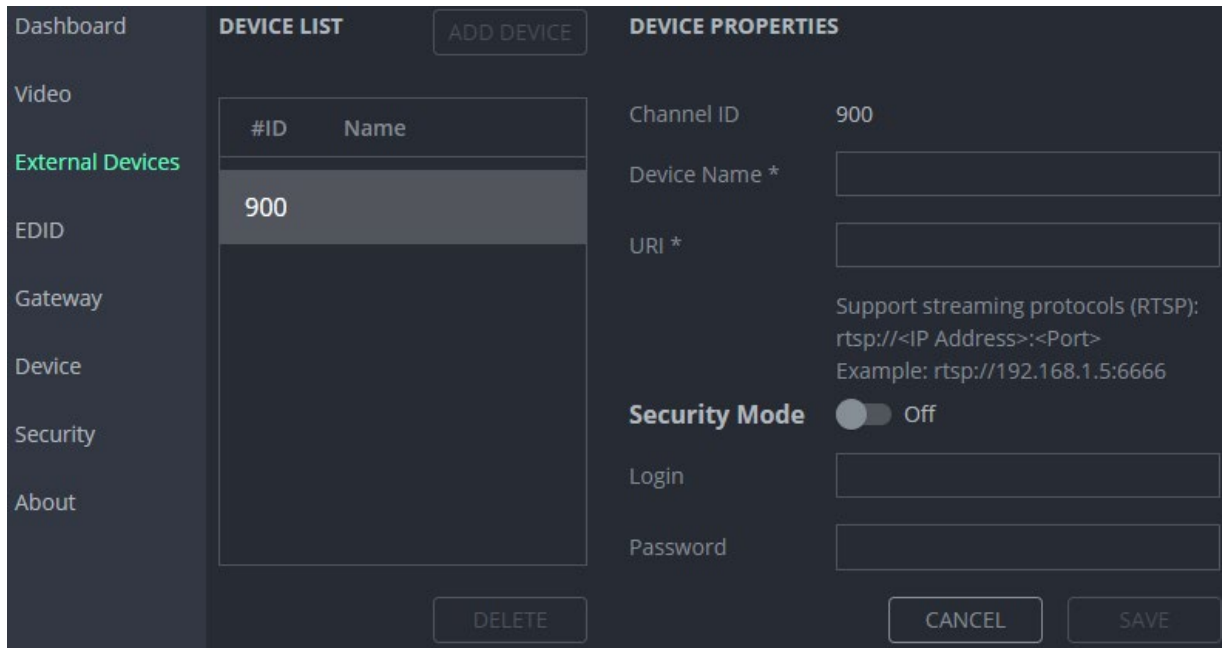

Figure 34: External Devices - Device Properties

3. Enter the (user friendly) **Device Name** and the **URI** of the device. The URI is in the format RTSP://<IP Address>: <Port>
4. If the stream requires a password, enable **Security Mode** and enter the login and password.
5. Click **SAVE**.
6. Third Party Devices (900-999) are also be displayed in the Dashboard's Channel ID drop-down list (see [Dashboard: Set channel and audio, view input signal](#) on page 34).

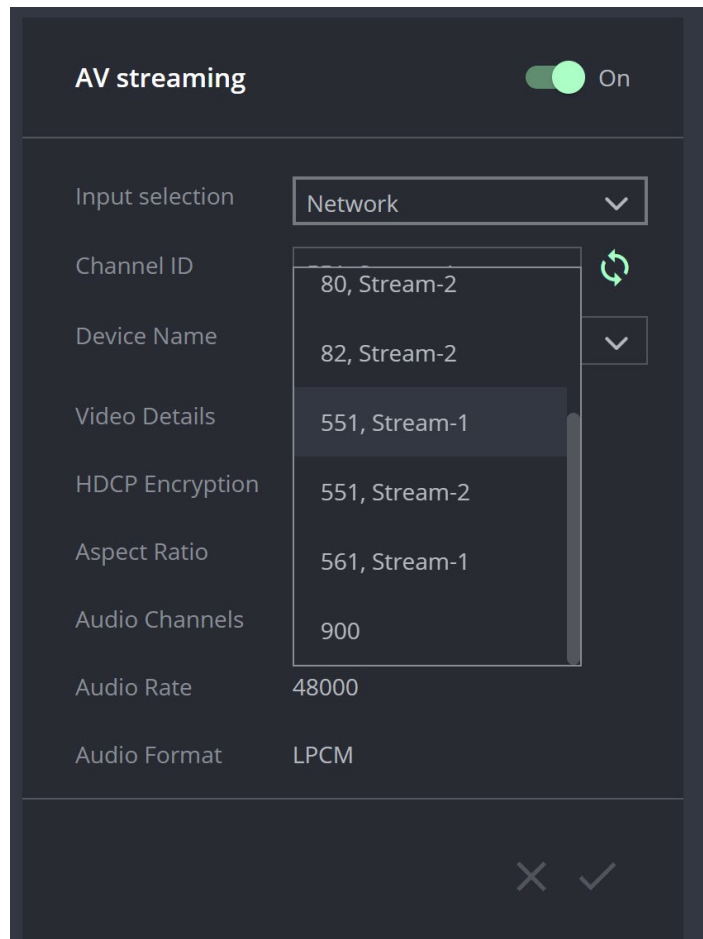

Figure 35: Dashboard – Channel ID dropdown list

EDID: *Set display metadata*

EDIDs (Extended Display Identification Data) contain metadata describing HDMI display device formatting and capabilities so that the output can be adjusted to match the display's requirements. EDIDs can be retrieved from the display, or a preset EDID can be used.

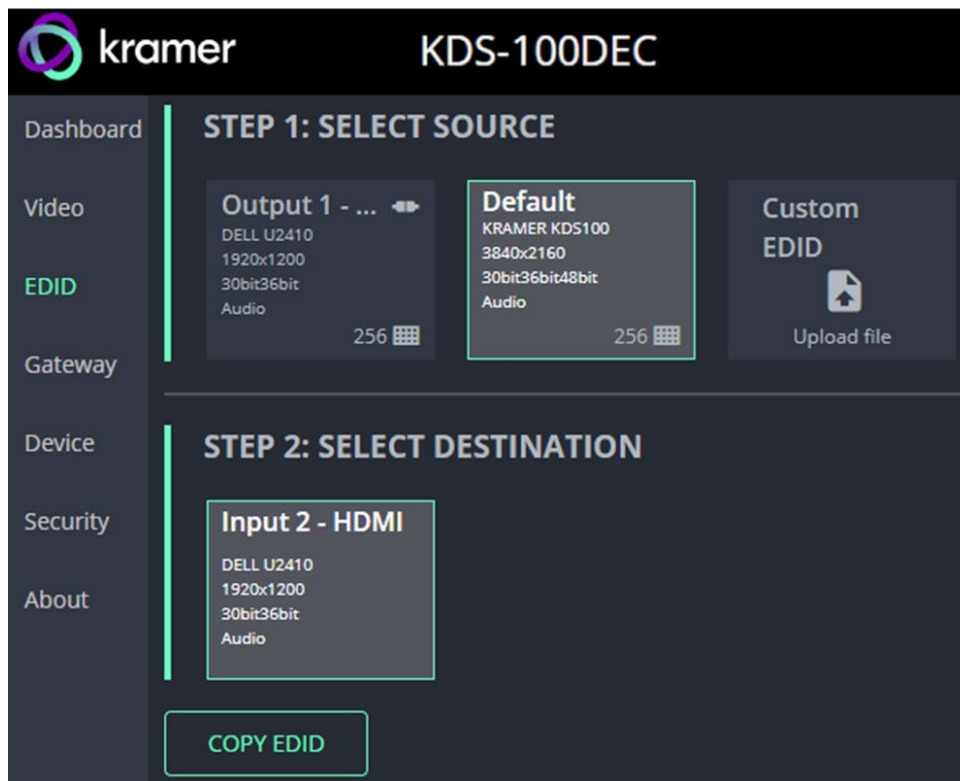

Figure 36: EDID pane

Step 1: Select Source.

To select an EDID, click a **Select Source** square (additional actions may be requested) and then click **COPY EDID** at the bottom; The selected EDID will then be copied to **Select Destination**.

Select Source options:

- **Output 1** - The EDID of the last used/current HDMI Out screen (click refresh to view a newly connected screen). Select the **Output 1** square to use this EDID. Click the bottom right corner **256** to view the EDID bitmap.
- **Default** – A default EDID is supplied with the **KDS-100DEC**. Click the bottom right corner **256** to view the EDID bitmap.
- **Custom EDID** - Upload a stored EDID file from your computer.

Step 2: Select Destination

Click **COPY EDID** and your selected EDID will be loaded into the destination square.

EDID is managed.

Gateway: *RS-232 settings*

To set the RS-232 Gateway:

1. Enable RS-232 (move the **RS-232 Gateway** slider to the right).
2. Choose between **Gateway** and **Remote Tunneling**. Use Gateway for a connected controller and Remote Tunneling if you are connecting an RS-232 extension delivering commands from a distance.
3. In **Gateway** mode, define the RS-232 gateway port (5001, by default).
In **Remote Tunneling** mode, **Remote Encoder ID** is the **KDS-100EN** channel number.
4. The following settings must match on the remote **KDS-100EN** encoder:
 - Enter the **Baud Rate** 50 to 921,600 (default is 9,600).
 - Enter the **Data Bits**: 5, 6, 7 or 8 (default).
 - Enter **Parity**: None (default), Odd, Even, Mark or Space.
 - Enter **Stop Bits**: 1 (default) or 2.
5. Click SAVE.

RS-232 Gateway is configured.

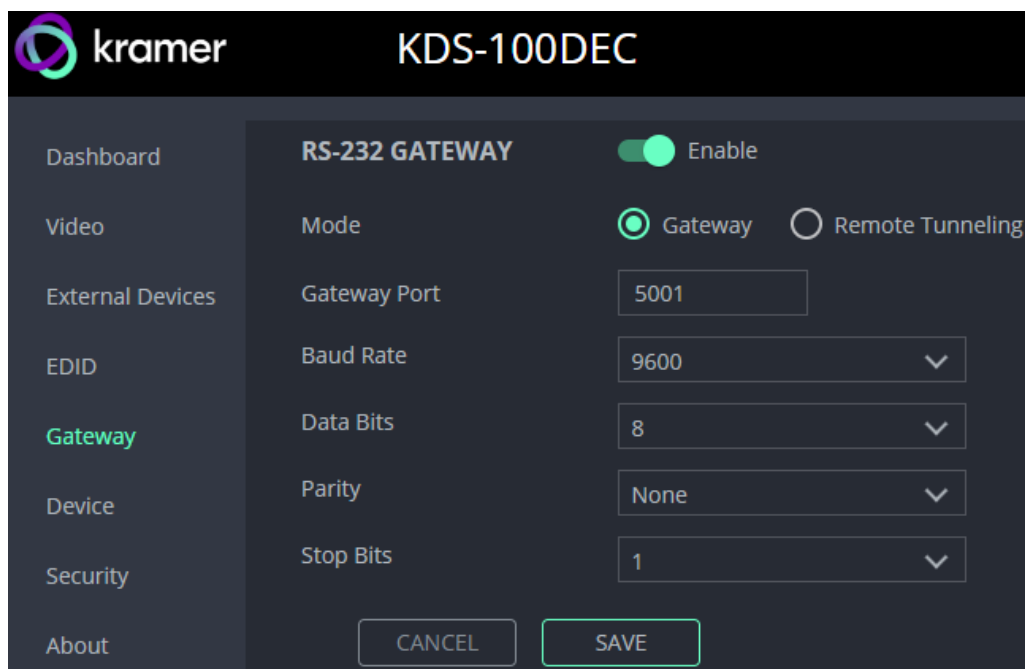



Figure 37: Gateway pane

Device: *General device, network and time settings*

 The **Device**, **Security** and **About** page's are the same in both **KDS-100EN** and **KDS-100DEC**.

The **Device** pane has three tabs:

- **General** – Sets the channel name, update firmware and reset or locate the device.
- **Network** – Set LAN and port parameters for the device.
- **Date & Time** – Define an NTP (network time protocol) server or set the time. An NTP server is recommended, as it coordinates the time between all the connected devices.

General tab

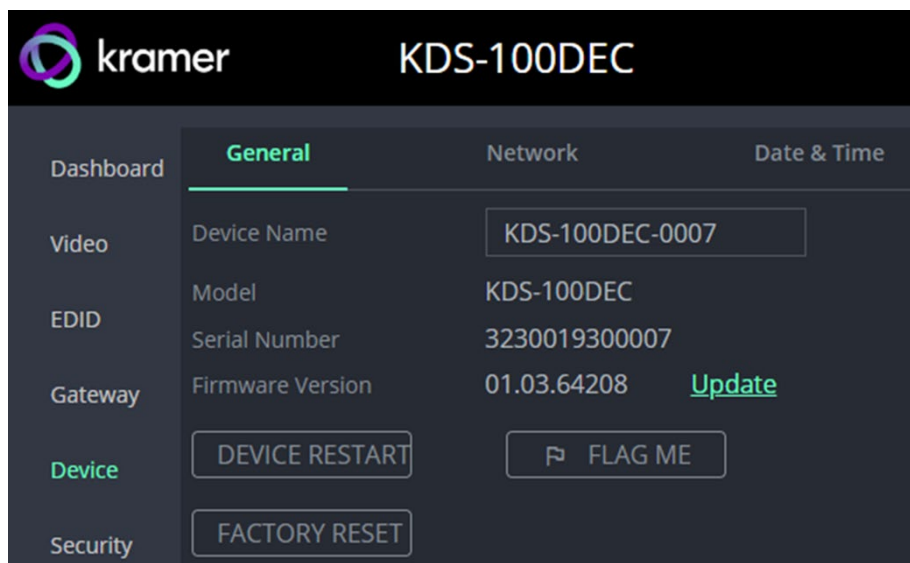



Figure 38: Device pane – General tab

- **Device name** – Edit or view the device's Host name.
- **Model and Serial Number**
- **Firmware Version** – To update the firmware download the latest version from <https://www.kramerav.com/downloads/kds-100en> to a local network location and then click **Update** to select and upload it.
- **Device Restart** – Click to restart the decoder (confirmation will be requested).
- **Factory Reset** - Click to reset the device's operation mode and restart the device (confirmation is requested).
- **Flag Me** – The LEDs will flash fast for 10 seconds to identify the device.

 When an HDMI OUT screen is connected without an input, the screen will show the device's IP address.

Network tab

Use the **KDS-100DEC Device** pane's **Network** tab to enable DHCP or, if you prefer, to define a static IP address.

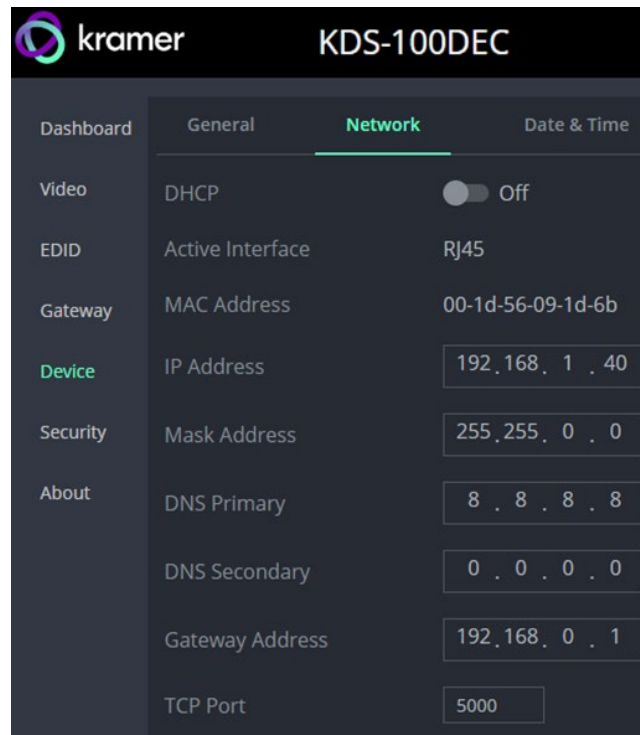

Figure 39: Device pane – Network tab

- **DHCP** – Set the slider to On, to have the DHCP server automatically define an IP address for the decoder.
- **Active Interface** – The current active output (HDMI or RJ45).
- **MAC Address** – MAC of the **KDS-100DEC**.
- Static IP definition fields: **IP Address**, **Mask Address**, **DNS (primary and secondary)** and **Gateway Address**. Not relevant if you are using a DHCP.
- **TCP Port** (default = 5000).

Date & Time tab

An NTP (Network Time Protocol) server should be used for KDS-100 series deployments. The NTP is essential for encoder and decoder synchronization, time stamping, and reliability in applications where coordination is critical. It helps prevent drift, jitter, out-of-sync data and contributes to reliable and efficient system operation.

Note: If no NTP server is available, it is possible to enter the address of a KDS-100 device (encoder or decoder), and the device will synchronize time to that device.

To sync device time and date from a network time server:

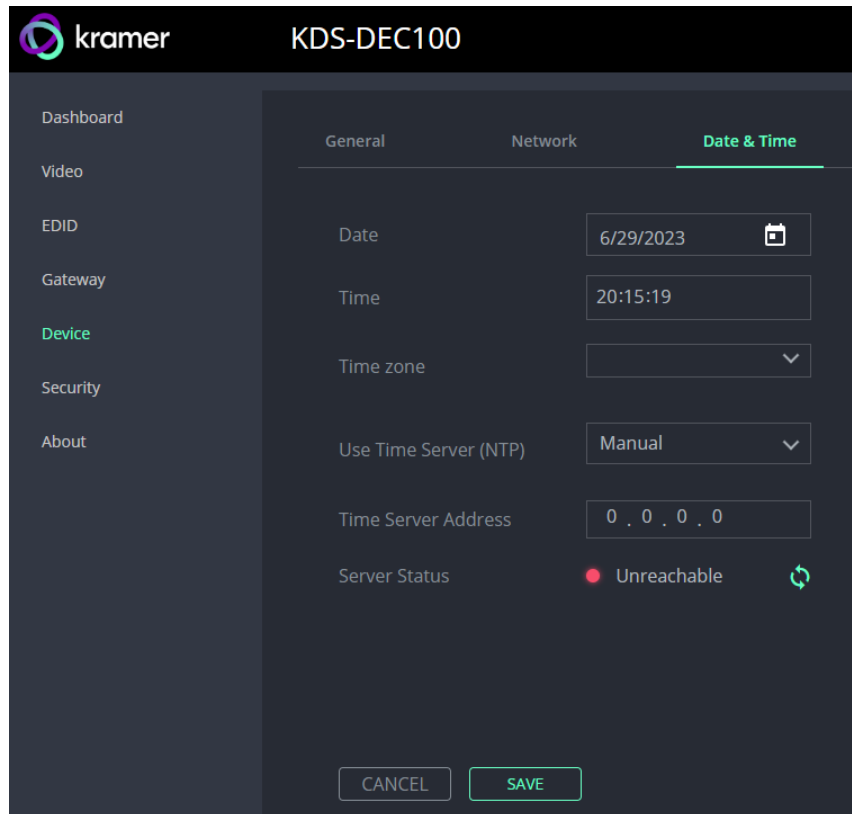



Figure 40: Device Pane – Date & Time tab

1. In the **Device** pane, select the **Date & Time** tab.
2. Set the **Time zone**.
3. Set **Use Time Server (NTP)**, to **On**.
4. Enter the **Time Server Address** IP (or the IP of a KDS-100 Series device that you are using as an alternative to a Time Server).
5. Click **SAVE**.

The devices date and time are synchronized to the server address entered.

Security: *Passwords, HTTPS and 802.1X*

-  Password protection is only active when the **Security Status** is On (default).
The default password is (username) Admin, (password) Admin.

The **KDS-100DEC** Security tab has three tabs:

- **Security** – Enable/disable security and change the device password.
- **HTTPS** – Use the device's internal certificate or upload a local certificate.
- **802.1X**- Enable and setup IEEE 802.1X authentication.

Security tab

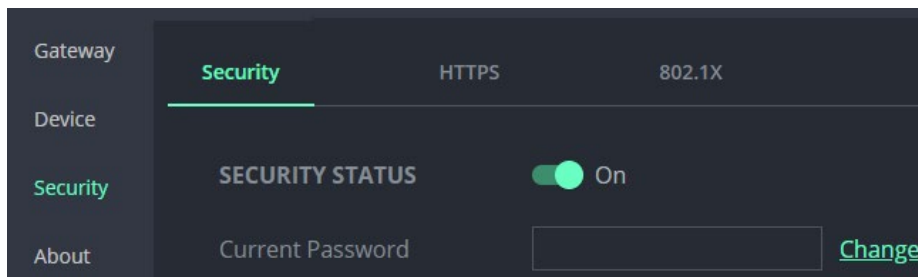

Figure 41: Security pane – Security tab

To change Security Status

Move the slider to enable/disable security. To disable security, enter the device's current password in the pop-up.

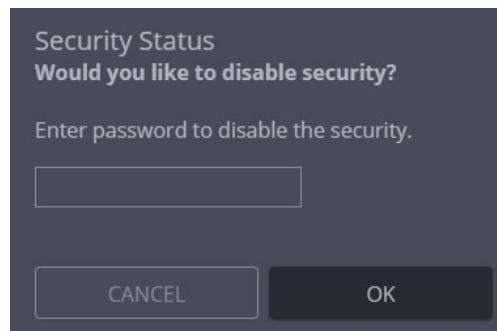

Figure 42: Security pane – pop-up

To change the password

Password protection is only available if the **Security Status** is On. To change the password, enter the **Current Password** and then click **Change**.

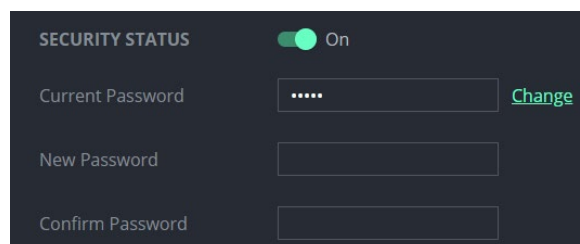



Figure 43: Security pane – Change password

HTTPS tab

To configure HTTPS:

1. In the **Security** pane's **Security** tab, **Security Status** must be enabled.
2. Select the **HTTPS** tab.
3. Select one of the following authentication methods:
 - **Internal Certificate** – Use the factory default certificate for authentication.
 - **Server Certificate** – Submit a certificate from the server for authentication (assigned by your network administrator). Click  to upload the certificate. Enter the private key password and click **APPLY & REBOOT**.

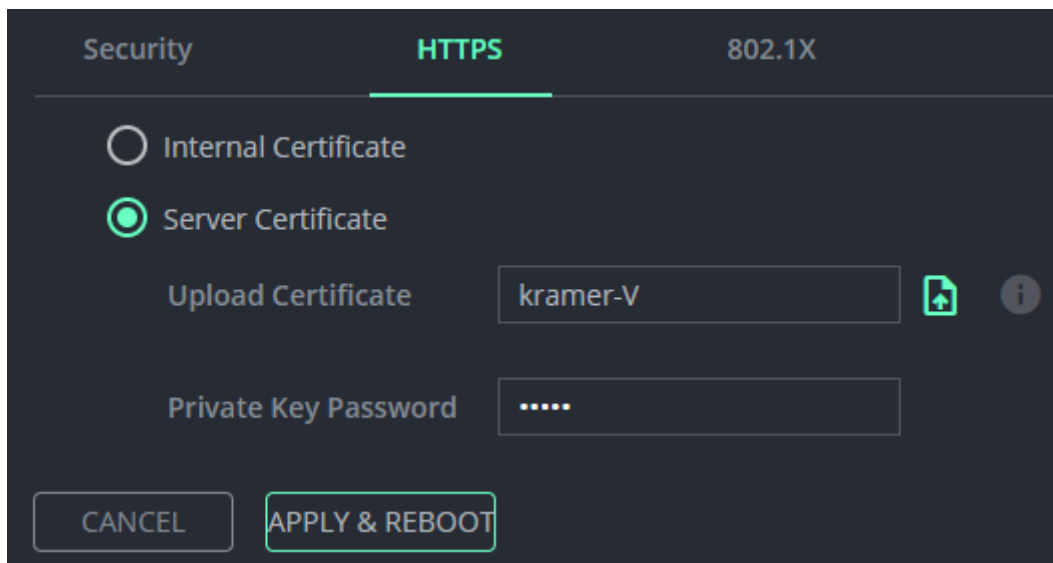



Figure 44: Security Tab – Server Certificate

4. Click **APPLY & REBOOT**.

HTTPS is configured.

802.1X tab

To configure IEEE 802.1X Authentication:

1. In the Security pane, select the 802.1X tab.
2. Set 802.1x authentication **ON**.
3. When set to ON check one of the following settings:
 - **EAP-MSCHAP V2** – This authentication method requires that you enter the **KDS-100DEC** username and password.
 - **EAP-TLS** – Submit a certificate from your network authentication server. To do so, enter the **KDS-100EN** Username (default Admin / Admin), click  to upload the certificates and keys, and enter the private key password (assigned by your network administrator).
Set **Server Certificate** to **On**.

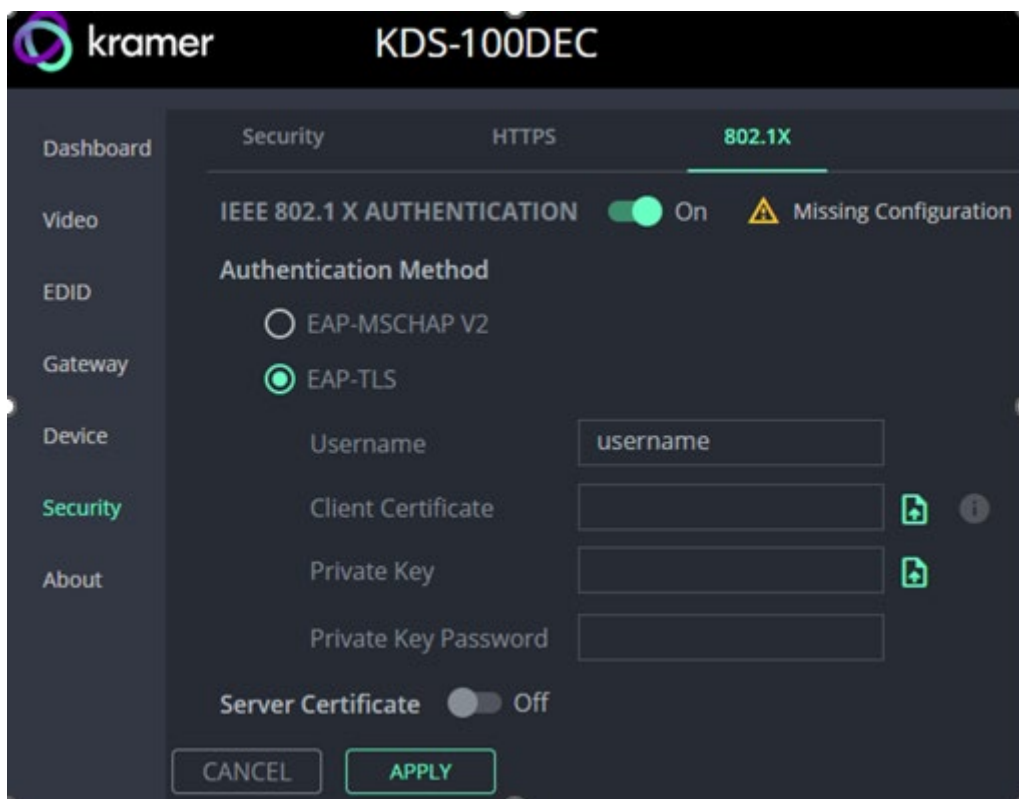

Figure 45: EAP-TLS – Certificates and Password

4. Click **APPLY**.

Security is configured.

About: *Web version and contact details*

View the web page release version and Kramer Electronics Ltd details.

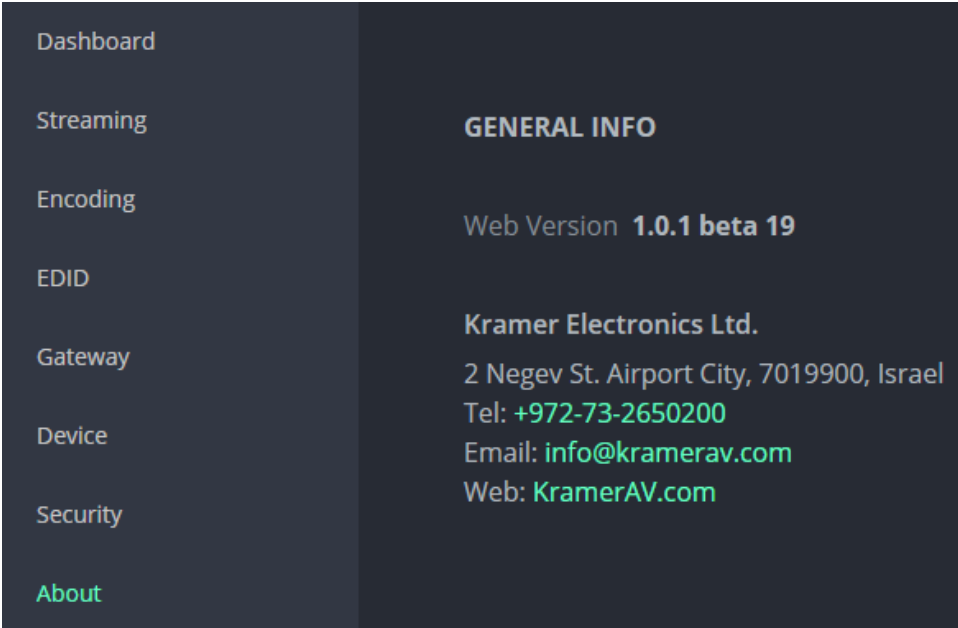

Figure 46: About Page

Upgrading Firmware

Upgrade the firmware, view the date of the last upgrade, or rollback to the previous firmware revision in case of a problem.



For support, contact the Kramer tech support team at support@kramerav.com.

To upgrade the firmware:

1. Download the latest firmware from the Kramer website at:

- **KDS-100EN** - <https://www.kramerav.com/downloads/kds-100en>
- **KDS-100DEC** - <https://www.kramerav.com/downloads/kds-100dec>



Firmware can also be downloaded from the **Resources** tab of the relevant product pages at www.kramerav.com/product/KDS-100EN#Tab_Resources.

2. In the embedded web pages, select the **Device** page. It will open on the **General** tab. This page is the same in both **KDS-100EN** and **KDS-100DEC**.

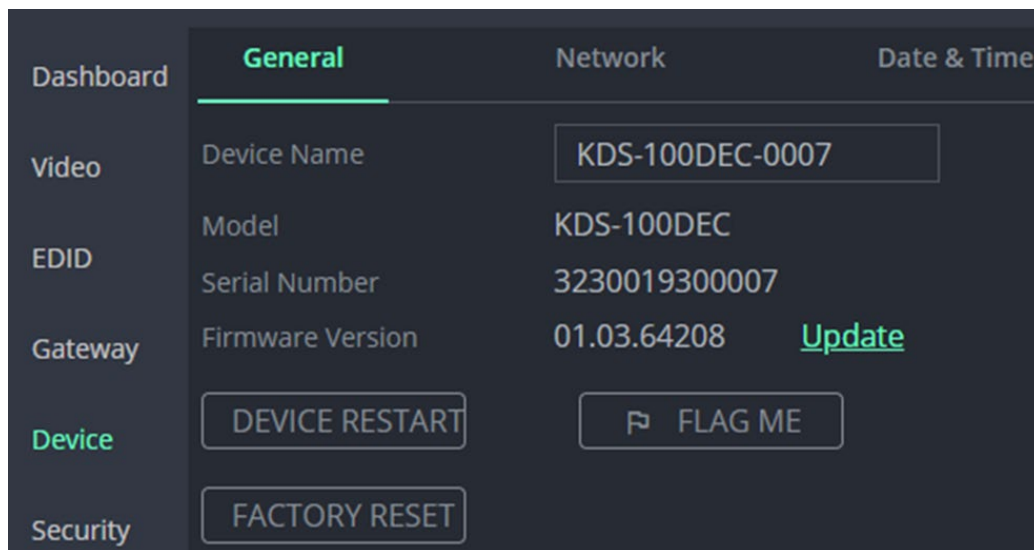

Figure 47: General Tab – Upgrading the Firmware

3. Next to **Firmware Version**, click **Update**.
 4. Select the Firmware file and click **Open**. The Firmware upgrade pop-up opens. Wait for upgrade completion.
 5. Once completed, refresh the web page and log-in.
- Firmware upgrade is complete.

Technical Specifications

KDS-100EN Specifications

Inputs	1 HDMI	On a female HDMI connector
	1 Balanced Audio	On a 5-pin terminal block connector
Outputs	1 HDMI	On a female HDMI connector
	1 Balanced Audio	On a 5-pin terminal block connector
Ports	1 Media/Control LAN PoE	On an RJ-45 female connector
	1 RS-232	On a 3-pin terminal block connector for control
	1 RS-232	On a 3-pin terminal block connector for extension
	1 Fiber on an LC Connector	Standard: 1000BASE-SX, 1000BASE-LX
Network	1 GE	
	IPv4	
	Multicast	IGMPv2
	RTP/RTCP	Over UDP
	MPEG-TS	
Video	RTSP	
	Max In/Out Resolution	3840x2160@60Hz 4:4:4
	HDCP (In/Out)	1.4 and 2.2
Video Streaming	Compression	H.264 / HEVC (H.265)
	Max Streaming Resolution	3840x2160@60Hz 4:2:2
	Bit Rate Range	1-60Mbps
	Latency	Low latency: About 40msec
	Dual streaming support	Primary: Up to 3840x2160@30Hz 4:2:2 Secondary: Up to 1920x 1080@60Hz 4:2:2
Security	HTTPS, 802.1x, OWASP-10	
User Interface	Indicators	LINK, NET and ON LEDs, front panel channel number display
	Rear Panel	Factory reset button
	Controls	Embedded web pages, P3K API commands via Ethernet, front panel channel selection buttons
Power	PoE+	IEEE 802.3at
	Optional Power Supply	12V DC, 5A
	Consumption	13.6W
Environmental Conditions	Operating Temperature	0° to +45°C (32° to 113°F)
	Storage Temperature	-20° to +70°C (-4° to 158°F)
	Humidity	10% to 90%, RHL non-condensing
Regulatory Compliance	Safety	CE, FCC
	Environmental	RoHs, WEEE
Dimensions	Net Dimensions (W, D, H)	21.5cm x 16.3cm x 4.4cm (8.5" x 6.4" x 1.72")
	Shipping Dimensions (W, D, H)	34.5cm x 16.5cm x 5.2cm (13.6" x 6.5" x 2.05")
Weight	Net Weight	0.9kg (2lbs) approx.
	Shipping Weight	1.4kg (3.1lbs) approx.
Specifications are subject to change without notice at www.kramerav.com		

KDS-100DEC Specifications

Inputs	1 HDMI	On a female HDMI connector
Outputs	1 HDMI	On a female HDMI connector
	1 Balanced Audio	On a 5-pin terminal block connector
Ports	1 Ethernet	On an RJ-45 female connector
	1 RS-232	On a 3-pin terminal block connector for control
	1 RS-232	On a 3-pin terminal block connector for data
	1 Fiber on an LC Connector	Standard: 1000BASE-SX, 1000BASE-LX
Network	1 GE	
	IPv4	
	Multicast	IGMPv2
	RTP/RTCP	Over UDP
	MPEG-TS	
	RTSP	
Video	Max In/Out Resolution	3840x2160K@60Hz 4:4:4
	HDCP	1.4 and 2.2
Video Streaming	Compression	H.264 / H.265
	Streaming Resolution	3840x2160K@60Hz 4:2:2
	Bit Rate Range	1-60Mbps
	Latency	Low latency About 40msec
	Scaler	Yes
Security	HTTPS, 802.1x, OWASP-10	
User Interface	Indicators	LINK, NET and ON LEDs, front panel channel number display
	Rear Panel	Factory reset button
	Controls	Embedded web pages, P3K API commands via Ethernet, front panel channel selection buttons
Power	PoE+	IEEE 802.3at
	Optional Power Adapter	12V DC, 5A
	Consumption	13.6W
Environmental Conditions	Operating Temperature	0° to +45°C (32° to 113°F)
	Storage Temperature	-20° to +70°C (-4° to 158°F)
	Humidity	10% to 90%, RHL non-condensing
Regulatory Compliance	Safety	CE, FCC
	Environmental	RoHs, WEEE
Dimensions	Net Dimensions (W, D, H)	21.5cm x 16.3cm x 4.4cm (8.5" x 6.4" x 1.72")
	Shipping Dimensions (W, D, H)	34.5cm x 16.5cm x 5.2cm (13.6" x 6.5" x 2.05")
Weight	Net Weight	0.9kg (2lbs) approx.
	Shipping Weight	1.4kg (3.1lbs) approx.
Specifications are subject to change without notice at www.kramerav.com		

Default Communication Parameters

P3K		
Example (stop encoder decoder activity)		#KDS-ACTION 0<CR>
Ethernet		
To reset the IP settings to the factory reset values go to: Menu->Setup -> Factory Reset-> press Enter to confirm		
	KDS-100EN	KDS-100DEC
DHCP	Default	Default
IP Address:	192.168.1.39	192.168.1.40
Subnet mask:	255.255.255.0	255.255.255.0
Default gateway:	192.168.1.254	192.168.1.254
TCP Port #:	5000	5000
UDP Port #:	50000	50000
Default username:	admin	admin
Default password:	admin	admin
Full Factory Reset		
Embedded web pages	Device Settings > General > RESET	
Front panel buttons	Press the RESET button on the rear panel for 10 seconds	

Protocol 3000

Kramer devices can be operated using Kramer Protocol 3000 commands sent via serial or Ethernet ports.

Understanding Protocol 3000

Protocol 3000 commands are a sequence of ASCII letters, structured according to the following.

- **Command format:**

Prefix	Command Name	Constant (Space)	Parameter(s)	Suffix
#	Command	_	Parameter	<CR>

- **Feedback format:**

Prefix	Device ID	Constant	Command Name	Parameter(s)	Suffix
~	nn	@	Command	Parameter	<CR><LF>

- **Command parameters** – Multiple parameters must be separated by a comma (,). In addition, multiple parameters can be grouped as a single parameter using brackets ([and]).
- **Parameters attributes** – Parameters may contain multiple attributes. Attributes are indicated with pointy brackets (<...>) and must be separated by a period (.).

The command framing varies according to how you interface with **KDS-100EN**. The following figure displays how the # command is framed using terminal communication software (such as Hercules):

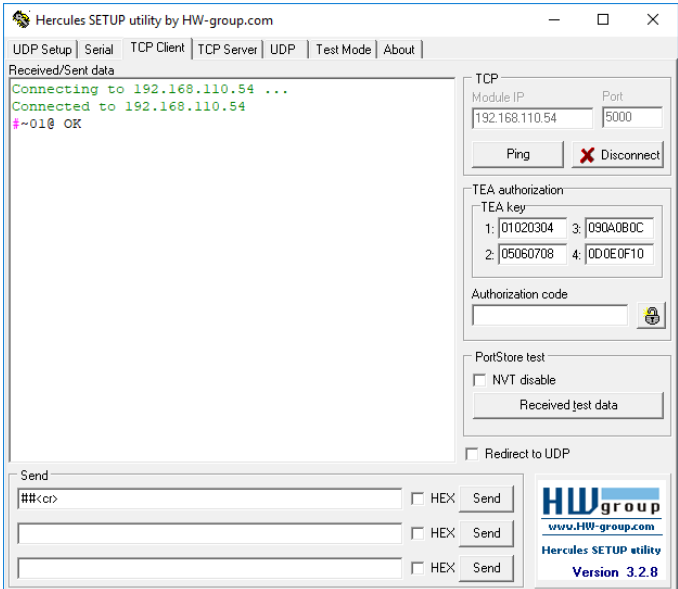

Protocol 3000 Commands

Function	Description	Syntax	Response	Parameters/Attributes	Example
#	Protocol handshaking. Validates the Protocol 3000 connection and gets the machine number. Step-in master products use this command to identify the availability of a device.	#<CR>	~nn@ok<CR><LF>		#<CR>
AUTH-802-1X-ENABLE	Set Authentication 802.1X feature for the device per specific interface.	#AUTH-802-1X-ENABLE Interface ID,state<CR>	~nn@AUTH-802-1X-ENABLE Interface ID,state<CR><LF>	Interface ID: – 0 State: 0,1 – Enable/Disable	Enable 802 Security of interface 0 #AUTH-802-1X-ENABLE 0,1<CR>
AUTH-802-1X-ENABLE?	Get Authentication 802.1X feature for the device per specific interface.	#AUTH-802-1X-ENABLE? Interface ID<CR>	~nn@AUTH-802-1X-ENABLE Interface ID,state<CR><LF>	Interface ID: – 0 State: 0,1 – Enable/Disable	Get 802 security status of interface 0 #AUTH-802-1X-ENABLE? 0<CR>
AUTH-802-1X-OP-STAT?	Get Authentication 802.1X operational status	#AUTH-802-1X-OP-STAT? Interface ID<CR>	~nn@AUTH-802-1X-OP-STAT Interface ID ,state<CR><LF>	Interface ID: – 0 State: 0 - 3 – Enable/Disable	802 authentication is running #AUTH-802-1X-OP-STAT? 0<CR>
BUILD-DATE?	Get device build date.	#BUILD-DATE?<CR>	~nn@BUILD-DATE date,time<CR><LF>	date – Format: YYYY/MM/DD time – Format: hh:mm:ss	Get the device build date: #BUILD-DATE?<CR>
COM-ROUTE	This command sets tunneling port routing. Every com port can send or receive data from the ETH port.	#COM-ROUTE com_id,port_type,port_id,eth_rep_en,ping_val<CR>	~nn@COM-ROUTE com_id,port_type,port_id,eth_rep_en,ping_val<CR><LF>	com_id – Machine dependent port_type – TCP/UDP 2 – TCP 1 – UDP port_id – TCP/UDP port number eth_rep_en – Ethernet Reply 0 – COM port does not send replies to new clients 1 – COM port sends replies to new clients. Ping_val – every x seconds the device sends an empty string to TCP client ("0") (0 to 3600)	Set tunneling for TCP port 5000; where the COM port sends replies to new clients and the keep alive time is 1: #COM-ROUTE 1,tcp,5000,1,1<CR>
COM-ROUTE?	Get tunneling port routing.	#COM-ROUTE? ,com_id<CR>	~nn@COM-ROUTE com_id,port_type,port_id,eth_rep_en,ping_val<CR><LF>	com_id – Machine dependent port_type – TCP/UDP 2 – TCP 1 – UDP port_id – TCP/UDP port number eth_rep_en – Ethernet Reply 0 – COM port does not send replies to new clients 1 – COM port sends replies to new clients. Ping_val – Every x seconds the device sends an empty string to TCP client ("0") (0 to 3600)	Get tunneling port routing for all route tunnels: #COM-ROUTE? ,*<CR>
COM-ROUTE-ADD	Add a communication route tunnel connection.	#COM-ROUTE-ADD com_id,port_type,port_id,eth_rep_en,timeout<CR>	~nn@COM-ROUTE-ADD com_id,port_type,port_id,eth_rep_en,timeout<CR><LF>	com_id – Machine dependent port_type – TCP/UDP 0 – TCP 1 – UDP port_id – TCP/UDP port number (5000 – 5999) eth_rep_en – Ethernet Reply 0 – COM port does not send replies to new clients 1 – COM port sends replies to new clients. timeout – Keep alive timeout in seconds (1 to 3600)	Add a communication route tunnel connection: #COM-ROUTE-ADD 1,1,1,1,1<CR>
COM-ROUTE-ENABLE	Enable/Disable RS-232 Gateway	#COM-ROUTE-ENABLE Connector ID,Mode<CR>	~nn@COM-ROUTE-ENABLE Connector ID,Mode<CR><LF>	Connector ID 1 Mode ON/OFF 0-1	Get RS-232 gateway status #COM-ROUTE-ENABLE 1,1<CR>
COM-ROUTE-ENABLE?	Get RS-232 gateway status	#COM-ROUTE-ENABLE? Connector ID<CR>	~nn@COM-ROUTE-ENABLE Connector ID,Mode<CR><LF>	Connector ID 1 Mode ON/OFF 0-1	Enable RS-232 Gateway #COM-ROUTE-ENABLE 1,1<CR>
CPEDID	Copy EDID data from the output to the input EEPROM	#CPEDID edid_io, src_id, dest_bitmap<CR>	~nn@CPEDID edid_io,src_id,dest_bitmap,safe_mode<CR><LF>	edid_io: EDID source type (usually output) 0 – Input / 1 – Output / 2 – Default EDID / 3 – Custom EDID src_id: Number of chosen source stage 0..N dest_bitmap: Bitmap representing destination IDs. Format: XXXX...X, where X is hex digit. The binary form of every hex digit represents corresponding destinations 0 – EDID data is not copied to this destination / 1 – EDID data is copied to this destination. safe_mode: Safe mode 0 – device accepts the EDID as is without trying to adjust 1 – device tries to adjust the EDID (default value if no parameter is sent).	Copy the EDID data from Output 1 (EDID source) to the Input: #CPEDID 1,1,0<CR>

Function	Description	Syntax	Response	Parameters/Attributes	Example
CPEDID-REMOTE	Load EDID from remote device.	#CPEDID-REMOTE Decoder output number,Decoder ID,Encoder Input,Destination ID,Decoder IP Address<CR>	~nn@CPEDID-REMOTE Decoder output number,Decoder ID,Encoder Input,Destination ID,Decoder IP Address<CR><LF>	Decoder output number - 1 Decoder ID - 1 Encoder Input number - 2 Destination ID - 2 Decoder IP Address - Valid IP Address	Copy EDID from Decoder output to Encoder input #CPEDID-REMOTE 1,1,2,2,192.168.58.3<CR>
DISPLAY?	Get the output's HPD (hot plug display) status	#DISPLAY? out_index<CR>	~nn@DISPLAY out_index,status<CR><LF>	out_index : Number that indicates the specific output. 1-N (N= the total number of outputs) status : HPD status according to signal validation. 0 – Signal or sink is not valid 1 – Signal or sink is valid 2 – Sink and EDID is valid.	Get the output HPD status of Output 1: #DISPLAY? 1<CR>
EDID-AUDIO	Set audio capabilities for input EDID.	#EDID-AUDIO Input_id, audio_mode<CR>	~nn@#EDID-AUDIO Input_id, audio_mode, <CR><LF>	input_id – 1- N. audio_mode : Force 2LPCM audio mode 0 - disable / 1 - Force 2LPCM enabled	Set force 2LPCM for Input 1: #EDID-AUDIO 1,1<CR>
EDID-AUDIO?	Get audio capabilities for input EDID.	#EDID-AUDIO Input_id, audio_mode<CR>	~nn@#EDID-AUDIO Input_id, audio_mode, <CR><LF>	Input_id – 1- N. Audio_mode : Force 2LPCM audio mode 0 - disable / 1 - Force 2LPCM enabled	Get force 2LPCM status or Input 1: #EDID-AUDIO? 1,hdmi<CR>
ETH-ACTIVE-PHY?	Get the status of the currently active connector – SFP/RJ-45	#ETH-ACTIVE-PHY? 1,mod,1<CR>	~nn@ETH-ACTIVE-PHY<CR><LF>	1,mod,1- parameters that indicates which interface is connected 1-2.	The SFP connector is active #ETH-ACTIVE-PHY? 1,2,1<CR>
ETH-PORT	Set Ethernet port protocol. If the port number you enter is already in use, an error is returned. The port number must be within the following range: 0-(2 ¹⁶ -1).	#ETH-PORT port_type,port_id<CR>	~nn@ETH-PORT port_type,port_id<CR><LF>	port_type – TCP/UDP port_id – when port_type = TCP: 5000~5099 when port_type = UDP: 50000~50999	Set the Ethernet port protocol for TCP to port 12457: #ETH-PORT TCP,5000<CR>
ETH-PORT?	Get Ethernet port protocol.	#ETH-PORT?_port_type<CR>	~nn@ETH-PORT port_type,port_id<CR><LF>	port_type – TCP/UDP port_id – when port_type = TCP: 5000~5099 when port_type = UDP: 50000~50999	
ETH-TUNNEL?	Get open tunnels parameters.	#ETH-TUNNEL? tunnel_id<CR>	~nn@ETH-TUNNEL tunnel_id,cmd_name,port_type,port_id,eth_ip,remote_port_id,eth_rep_en,connection_type<CR><LF>	tunnel_id : Tunnel ID number * (get all open tunnels) cmd_name : UART number port_type : TCP/UDP 0 – TCP 1 – UDP port_id : TCP/UDP port number eth_ip : Client IP address remote_port_id : Remote port number eth_rep_en : Ethernet Reply 0 – COM port does not send replies to new clients 1 – COM port sends replies to new clients Connection_type 0 – not wired connection 1 – wired connection	Get Tunnel id 1 details #ETH-TUNNEL? 1<CR>
FACTORY	Reset device to factory default configuration. This command deletes all user data from the device. The deletion can take some time. Your device may require powering off and powering on for the changes to take effect.	#FACTORY<CR>	~nn@FACTORY_ok<CR><LF>		Reset the device to factory default configuration: #FACTORY<CR>
GEDID?	Get EDID data on certain input/output.	#GEDID io_mode,in_index<CR>	~nn@GEDID io_mode,in_index,size,Binary DATA<CR><LF>	io_mode : Input/Output 0 – Input, 1 – Output, 2 – Default EDID, 3 – Custom EDID in_index : Number that indicates the specific input 1-N (N= the total number of inputs) size : Size of data to be sent from device 0 means no EDID support Binary DATA : EDID Binary data in binary format.	Get EDID data for input #1: #GEDID? 0,1<CR>

Function	Description	Syntax	Response	Parameters/Attributes	Example
HDCP-MOD	Set HDCP mode. HDCP supported - HDCP_ON [default]. HDCP not supported - HDCP OFF. HDCP support changes following detected sink - MIRROR OUTPUT. When you define 3 as the mode, the HDCP status is defined according to the connected output in the following priority: OUT 1, OUT 2. If the connected display on OUT 2 supports HDCP, but OUT 1 does not, then HDCP is defined as not supported. If OUT 1 is not connected, then HDCP is defined by OUT 2.	#HDCP-MOD in_index,mode<CR>	~nn@HDCP-MOD in_index,mode<CR><LF>	in_index – Number that indicates the specific input: 1-N (N= the total number of inputs) mode – HDCP mode: 0 – HDCP Off 1 – HDCP On 3 – HDCP Mirror Mode - used by KDS-7 decoder to allow an HDCP 2.2 source connected to the encoder to play on an HDCP 1.4 TV/display connected to the decoder.	Set the input HDCP-MODE of IN 1 to Off: #HDCP-MOD_1,0<CR>
HDCP-MOD?	Get HDCP mode. Set HDCP working mode on the device input. HDCP supported - HDCP_ON [default]. HDCP not supported - HDCP OFF. HDCP support changes following detected sink - MIRROR OUTPUT.	#HDCP-MOD?_j,in_index<CR>	~nn@HDCP-MOD in_index,mode<CR><LF>	in_index – Number that indicates the specific input: 1-N (N= the total number of inputs) mode – HDCP mode: 0 – HDCP Off 1 – HDCP On 3 – HDCP Mirror Mode - used by KDS-7 decoder to allow an HDCP 2.2 source connected to the encoder to play on an HDCP 1.4 TV/display connected to the decoder.	Get the input HDCP-MODE of IN 1 HDMI: #HDCP-MOD?_1<CR>
HDCP-STAT?	Get HDCP signal status. io_mode = 1 – get the HDCP signal status of the sink device connected to the specified output. io_mode = 0 – get the HDCP signal status of the source device connected to the specified input.	#HDCP-STAT? io_mode,in_index<CR>	~nn@HDCP-STAT io_mode,in_index,status<CR><LF>	io_mode – Input/Output 0 – Input 1 – Output in_index – Number that indicates the specific number of inputs or outputs (based on io_mode): 1-N (N=total number of inputs or outputs) status – Signal encryption status - valid values On/Off 0 – HDCP Off 1 – HDCP On	Get the output HDCP-STATUS of IN 1: #HDCP-STAT?_0,1<CR>
HELP	Get command list or help for specific command.	#HELP<CR> #HELP_<cmd_name><CR>	1. Multi-line: ~nn@Device_<cmd_name>,<cmd_name><CR><LF> To get help for command use: HELP (COMMAND_NAME)<CR><LF> ~nn@HELP <cmd_name>:<CR><LF> <description><CR><LF> USAGE:<usage><CR><LF>	cmd_name – Name of a specific command	Get the command list: #HELP<CR> To get help for AV-SW-TIMEOUT: HELP av-sw-timeout<CR>
IDV	Set visual indication from device. Using this command, some devices can light a sequence of buttons or LEDs to allow identification of a specific device from similar devices.	#IDV<CR>	~nn@IDV_<ok><CR><LF>		#IDV<CR>
KDS-ACTION	Set action to perform by encoder/decoder.	#KDS-ACTION_<kds_mode><CR>	~nn@KDS-ACTION <kds_mode><CR><LF>	kds_mode – Action (state) for encoder/decoder 0 – Stop 1 – Play 2 – Save config	Stop the encoder/decoder: #KDS-ACTION_0<CR>
KDS-ACTION?	Get last action (state) performed by encoder/decoder.	#KDS-ACTION?<CR>	~nn@KDS-ACTION <kds_mode><CR><LF>	kds_mode – Action (state) for encoder/decoder 0 – Stop 1 – Play 2 – Save config	Get the last action performed by the encoder/decoder: #KDS-ACTION?<CR>
KDS-APPLY	Save configuration for all inputs	#KDS-APPLY * <CR>	~nn@KDS-APPLY all<CR><LF>	all: Save all inputs configuration *	Save configuration for all inputs #KDS-APPLY *<CR>
KDS-AUD	Set audio source/destination.	#KDS-AUD_<mode><CR>	~nn@KDS-AUD <mode><CR><LF>	mode – Encoder/decoder audio mode If set as encoder: 0 – HDMI input 1 – Analog input 2 – None 4 – Dante If set as decoder: 0 – HDMI output 1 – Analog output 2 – Both 3 – None 4 – Dante	Set audio source/destination: #KDS-AUD_1<CR>

Function	Description	Syntax	Response	Parameters/Attributes	Example
KDS-AUD?	Get audio source/destination.	#KDS-AUD?<CR>	~nn@KDS-AUD mode<CR><LF>	mode – Encoder/decoder audio mode If set as encoder: 0 – HDMI input 1 – Analog input 2 – None 4 – Dante If set as decoder: 0 – HDMI output 1 – Analog output 2 – Both 3 – None 4 – Dante	Get audio source/destination: #KDS-AUD?<CR>
KDS-B-FRAMES	Set current streaming b-frames	#KDS-B-FRAMES input,B-Frames<CR>	~nn@KDS-B-FRAMES input,B-Frames<CR><LF>	input: 1-N B-Frames: Value 0-4.	Set B-Frames of input 1 to 0 #KDS-B-FRAMESV1,0<CR>
KDS-B-FRAMES?	Get current streaming b-frames	#KDS-B-FRAMES? input<CR>	~nn@KDS-B-FRAMES input,B-Frames<CR><LF>	input: 1-N B-Frames: Value 0-4.	Get B-Frames of input 1 #KDS-B-FRAMES? 1<CR>
KDS-BR?	Get bit rate. Available only in encoders where encoding method is H264 (see KDS-EN command).	#KDS-BR? <CR>	~nn@KDS-BR bitrate<CR><LF>	None	Get bit rate: #KDS-BR?<CR>
KDS-CONN	Set streaming connection parameters. RTSP connection configuration is available only when RTSP Streaming Protocol is configured (See KDS-PROT command).	#KDS-CONN ip,stream_port,folder<CR>	~nn@KDS-CONN ip,stream_port,folder<CR><LF>	ip stream_port – stream port folder – folder name	Set streaming connection parameters: #KDS-CONN 1,1,1<CR>
KDS-CONN?	Get streaming connection parameters. RTSP connection configuration is available only when RTSP Streaming Protocol is configured (See KDS-PROT command).	#KDS-CONN?<CR>	~nn@KDS-CONN ip,stream_port,folder<CR><LF>	ip stream_port – stream port folder – folder name	Get current streaming connection parameters: #KDS-CONN?<CR>
KDS-CS?	Get color space of the source	#KDS-CS? Input<CR>	~nn@KDS-CS Input,Color Space<CR><LF>	Input: Input ID 1	Get Input 1 color space information #KDS-CS? 1<CR>
KDS-DEFINE-CHANNEL	Set Encoder AV channel.	#KDS-DEFINE-CHANNEL ch_id<CR>	~nn@KDS-DEFINE-CHANNEL ch_id<CR><LF>	ch_id – Number that indicates the specific input 1-999.	Tune the encoder: #KDS-DEFINE-CHANNEL 1<CR>
KDS-DEFINE-CHANNEL?	Get Encoder AV channel.	#KDS-DEFINE-CHANNEL?<CR>	~nn@KDS-DEFINE? ch_id<CR><LF>	ch_id – Number that indicates the specific input 1-999.	Get channel ID: #KDS-DEFINE-CHANNEL?<CR>
KDS-EN	Set encoding method to encoder/decoder.	#KDS-EN method<CR>	~nn@KDS-EN method<CR><LF>	Method 0-encoder, 1-decoder	Set encoding method to decoder: #KDS-EN 1<CR>
KDS-EN?	Get encoding method.	#KDS-EN?<CR>	~nn@KDS-EN method<CR><LF>	Method 0-encoder, 1-decoder	Get encoding method: #KDS-EN 1<CR>
KDS-FR?	Get frame rate.	#KDS-FR?<CR>	~nn@KDS-FR value<CR><LF>	value: Frame rate in frames per second.	Get frame rate: #KDS-FR?<CR>
KDS-GOP?	Get GOP (group of pictures)size. Available only in encoders where encoding method is H264 (see KDS-EN command).	#KDS-GOP?<CR>	~nn@KDS-GOP value<CR><LF>	Value: GOP size.	Get GOP size: #KDS-GOP?<CR>
KDS-IDR	Set Encoder IDR (Instantaneous Decoder Refresh) Frequency.	#KDS-IDR Input,IDR Frequency<CR>	~nn@KDS-IDR Input,IDR Frequency<CR><LF>	Input: Input 1-2 IDR Frequency: -1 – infinite.	Set Input 1 IDR frequency of 60 #KDS-IDR 1,60<CR>
KDS-IDR?	Get Encoder IDR Frequency.	#KDS-IDR? Input<CR>	~nn@KDS-IDR Input,IDR Frequency<CR><LF>	Input: Input 1-2 IDR Frequency: -1 – infinite.	Get IDR Frequency of input 1 #KDS-IDR? 1<CR>
KDS-METHOD?	Get unicast / multicast streaming method. Available only when RTP Streaming Protocol is configured (see KDS-PROT command).	#KDS-METHOD?<CR>	~nn@KDS-METHOD method<CR><LF>	method – Streaming method 1 – Unicast 2 – Multicast	Get current streaming method of encoder/decoder: #KDS-METHOD<CR>
KDS-MOD?	Get device current working mode.	#KDS-MOD?<CR>	~nn@KDS-MOD mode<CR><LF>	mode: Device working mode 3 – HIGH_QUALITY.	Get device current working mode: #KDS-MOD?<CR>

Function	Description	Syntax	Response	Parameters/Attributes	Example
KDS-MULTICAST	Set multicast group address and TTL value (encoder mode only). Multicast groups are identified by special IP addresses between the range of 224.0.0.0 and 239.255.255.255. Addresses within the 224.0.0.0 range are commonly reserved for local subnet communications. TTL is the time to live of the datagram to avoid it being looped forever due to routing errors.	#KDS-MULTICAST group_ip,ttl<CR>	~nn@KDS-MULTICAST group_ip,ttl<CR><LF>	group-ip - Multicast group IP used for streaming packets in Multicast Streaming Method. ttl - Time to Live of the streamed packets.	Set multicast group address and TTL value #KDS-MULTICAST <u>225.225.0.10.1</u> <CR>
KDS-MULTICAST?	Get multicast group address and TTL value.	#KDS-MULTICAST?<CR>	~nn@KDS-MULTICAST group_ip,ttl<CR><LF>	group-ip - Multicast group IP used for streaming packets in multicast streaming method. ttl - Time to Live of the streamed packets.	Set multicast group address and TTL value #KDS-MULTICAST <u>225.225.0.10.1</u> <CR>
KDS-MULTICAST-PREFIX	Set multicast group address value.	#KDS-MULTICAST-PREFIX Input,Octet 1,Octet 2,Octet 3,Octet 4<CR>	~nn@KDS-MULTICAST-PREFIX Input,Octet 1,Octet 2,Octet 3,Octet 4<CR><LF>	Input: 1-2 Octet 1: 224-239 Octet 2: 0-255 Octet 3: 0 Octet 4: 0	Set Multicast Prefix of input 2 to 230.3.0.0 #KDS-MULTICAST-PREFIX 2,230,3,0,0<CR>
KDS-MULTICAST-PREFIX?	Get multicast group address value.	#KDS-MULTICAST-PREFIX Input<CR>	~nn@KDS-MULTICAST-PREFIX Input,Octet 1,Octet 2,Octet 3,Octet 4<CR><LF>	Input: 1-2 Octet 1: 224-239 Octet 2: 0-255 Octet 3: 0 Octet 4: 0	Set Multicast Prefix of input 2 to 230.3.0.0 #KDS-MULTICAST-PREFIX 2,230,3,0,0<CR>
KDS-NUM-SLICES	Set current streaming number of slices produced for each frame.	#KDS-NUM-SLICES Input,Slices<CR>	~nn@KDS-NUM-SLICES Input,Slices<CR><LF>	Input: Input 1-N Slices: Slice Value 4-32	Set 8 slices per frame to input 1. #KDS-NUM-SLICES 1,8<CR>
KDS-NUM-SLICES?	Get current streaming number of slices produced for each frame.	#KDS-NUM-SLICES? Input<CR>	~nn@KDS-NUM-SLICES Input,Slices<CR><LF>	Input: Input 1-N Slices: Slice Value 4-32	Get Slice value of input 1 #KDS-NUM-SLICES? 1<CR>
KDS-OP-STAT?	Get streaming operational status.	#KDS-OP-STAT?<CR>	~nn@KDS-OP-STAT value<CR><LF>	value: Streaming operational status 0 – running 1 – Not_running/stop 2 – error.	Get streaming operational status: #KDS-OP-STAT?<CR>
KDS-PROT?	Get current streaming protocol of encoder/decoder.	#KDS-PROT? stream<CR>	~nn@KDS-PROT protocol<CR><LF>	Stream: 1 encoder, 2 decoder. protocol: Encoder/decoder streaming protocol 0 – RTP, 1 - RTSP	Get current streaming protocol of encoder/decoder: #KDS-PROT? 1/2<CR>
KDS-RESOL?	Get actual AV stream resolution.	#KDS-RESOL? io_mode,io_index,is_native<CR>	~nn@KDS-RESOL? io_mode,io_index,is_native,resolution<CR><LF>	io_mode: Input/Output 0 – Input 1 – Output io_index: Number that indicates the specific input or output port. 1-N (N= the total number of input or output ports) is_native: Native resolution flag 0 – Off 1 – On resolution: Resolution index 0=No Signal (for input) / Native – EDID (for output) 31=1920x1080p@50Hz 34=1920x1080p@29.97Hz/30Hz 74=3840x2160p@30Hz 76=3840x2160p@60Hz	
KDS-RTP-PARAM	Set RTP (real-time transport protocol) video and audio port.	#KDS-RTP-PARAM Stream number,Video port,Audio port<CR>	~nn@KDS-RTP-PARAM Stream number,Video port,Audio port<CR><LF>	Stream number: Stream number 1-2 Video port: Video port 1-64000 Audio port: Audio port 1-64000	Set stream #1 video port = 5056, audio port=5060 #KDS-RTP-PARAM 1,5056,5060<CR>
KDS-RTP-PARAM?	Get RTP video and audio port.	#KDS-RTP-PARAM? Stream number<CR>	~nn@KDS-RTP-PARAM Stream number,Video port,Audio port<CR><LF>	Stream number: Stream number 1-2 Video port: Video port 1-64000 Audio port: Audio port 1-64000	Get stream #1 Video/audio port #KDS-RTP-PARAM ?1<CR>
KDS-SCALE	Set scaling mode. Encoder only, requires a reboot to activate. Scaling is only supported from resolutions: up-scaled 720p to 1080p, and down-scaled 1080p to 720p.	#KDS-SCALE value<CR>	~nn@KDS-SCALE value,res_type<CR><LF>	value – Streamer Decoder Scaling Mode 0 – Pass Thru 1 – Scaling res_type – The resolution mode on the display, for example “S:1920x1080p-60”	Set scaling mode: #KDS-SCALE ?1<CR>
KDS-SCALE?	Get scaling mode.	#KDS-SCALE? <CR>	~nn@KDS-SCALE value,res_type<CR><LF>	value – Streamer Decoder Scaling Mode 0 – Pass Thru 1 – Scaling res_type – The resolution mode on the display, for example “S:1920x1080p-60”	Get scaling mode #KDS-SCALE?<CR>
KDS-SCALE-CS	Set KDS Scale Color Space.	#KDS-SCALE-CS stream_id,scaling_color_space<CR>	~nn@KDS-SCALE-CS<CR><LF>	stream_id number 1 - 2 scaling_color_space: 0 - ScalingColorSpace_NV12_4_2_0, 1 - ScalingColorSpace_NV16_4_2_2, (0 – 1)	Set Scaling Color Space Stream 1 to NV12_4_2_0 #KDS-SCALE-CS 1,0<CR>
KDS-SCALE-CS?	Get KDS Scale Color Space.	#KDS-SCALE-CS? stream_id<CR>	~nn@KDS-SCALE-CS<CR><LF>	stream_id: stream id number 1 - 2	Get Scaling Color Space Stream 1 #KDS-SCALE-CS? 1<CR>

Function	Description	Syntax	Response	Parameters/Attributes	Example
KDS-SCALE-LIST?	Return list of supported video resolutions.	#KDS-SCALE-LIST? stream_id <CR>	~nn@KDS-SCALE-LIST<CR><LF>	stream_id: stream id number 1 - 2	Get decoder scaling list from stream_id 1 #KDS-SCALE-LIST? 1<CR>
KVM-MASTER	Set KVM Master Name.	#KVM-MASTER Name<CR>	~nn@KVM-MASTER Name<CR><LF>	Name: IP address boundary to ip address	Set KVM ip address of 192.168.30.3 #KVM-MASTER 192.168.30.3<CR>
KVM-MASTER?	Get KVM Master Name.	#KVM-MASTER?<CR>	~nn@KVM-MASTER Name<CR><LF>	Name: IP address boundary to ip address	Get KVM ip address #KVM-MASTER?<CR>
KVM-MODE	Set KVM Mode enable/disable.	#KVM-MODE Mode<CR>	~nn@KVM-MODE Mode<CR><LF>	Mode: Mode ON/OFF	Enable KVM #KVM-MODE ON<CR>
KVM-MODE?	Get KVM Mode.	#KVM-MODE?<CR>	~nn@KVM-MODE Mode<CR><LF>	Mode: Mode ON/OFF	Get KVM status #KVM-MODE?<CR>
LDEDID	Write EDID data from external application to device. When the unit receives the LDEDID command it replies with READY and enters the special EDID packet wait mode. In this mode the unit can receive only packets and not regular protocol commands. If the unit does not receive correct packets for 30 seconds or is interrupted for more than 30 seconds before receiving all packets, it sends a timeout error ~nn@LDEDID err01<CR><LF> and returns to the regular protocol mode. If the unit received data that is not a correct packet, it sends the corresponding error and returns to the regular protocol mode.	#LDEDID edid_io,dest_bitmask,edid_size, safe_mode<CR>	~nn@LDEDID edid_io,dest_bitmask,edid_size, safe_mode,ready<CR><LF>	edid_io: EDID destination type (usually input) 0 – Input, 1 – Output, 2 – Default EDID 3 – Custom EDID dest_bitmask: Bitmap representing destination IDs. Format: 0x*****, where * is ASCII presentation of hex digit. The binary presentation of this number is a bit mask for destinations. Setting '1' means EDID data has to be copied to this destination. edid_size: EDID data size. safe_mode: Safe mode. 0 – Device accepts the EDID as is without trying to adjust, 1 – Device tries to adjust the EDID. ready: Data in protocol packets Using the Packet Protocol Send a command: LDRV, LOAD, IROUT, LDEDID Receive Ready or ERR### If ready: a. Send a packet, b. Receive OK on the last packet, c. Receive OK for the command packet structure: Packet ID (1, 2, 3...) (2 bytes in length) Length (data length + 2 for CRC) – (2 bytes in length) Data (data length - 2 bytes) CRC – 2 bytes 01 02 03 04 05 Packet ID Length Data CRC 5. In response: ~nnnn ok (Where NNNN is the received packet ID in ASCII hex digits).	
MODEL?	Get device model.	#MODEL?<CR>	~nn@MODEL model_name<CR><LF>	model_name: String of up to 19 printable ASCII chars.	Get the device model: #MODEL? <CR>
NAME	Set the device's DNS name. Requires DNS feature is on. Sets a DNS identifier, not the model name.	#NAME machine_name<CR>	~nn@NAME machine_name<CR><LF>	machine_name: String of up to 15 alpha-numeric chars (can include hyphen, not at the beginning or end).	Set the DNS name of the device to room-442: #NAME room-442<CR>
NAME?	Get the device's DNS name.	#NAME?<CR>	~nn@NAME machine_name<CR><LF>	machine_name: String of up to 15 alpha-numeric chars (can include hyphen, not at the beginning or end).	Get the DNS name of the device: #NAME?<CR>
NAME-RST	Reset device's DNS name to factory default. Factory default DNS name is "KRAMER_" + 4 last digits of device serial number.	#NAME-RST<CR>	~nn@NAME-RST_ok<CR><LF>		Reset the machine name (S/N last digits are 0102): #NAME-RST kramer_0102<CR>
NET-CONFIG	Set a network configuration. For Backward compatibility, the network ID can be omitted. In this case, the Network ID, by default, is 0, which is the Ethernet control port. If the gateway address is not compliant with the subnet mask used for the host IP, the command will return an error. Subnet and gateway compliancy specified by RFC950.	#NET-CONFIG netw_id,net_ip,net_mask,gateway,[dns1],[dns2]<CR>	~nn@NET-CONFIG netw_id,net_ip,net_mask,gateway<CR><LF>	netw_id – Network ID—the device network interface (if there are more than one). Counting is 0 based, meaning the control port is '0', additional ports are 1,2,3.... net_ip – Network IP net_mask – Network mask gateway – Network gateway [DNS1],[DNS2] - Parameters [DNS1] and [DNS2] are optional.	Set the device network parameters to IP address 192.168.113.10, net mask 255.255.0.0, and gateway 192.168.0.1: #NET-CONFIG 0,192.168.113.10,255.255.0.0,192.168.0.1<CR>
NET-CONFIG?	Get the network configuration.	#NET-CONFIG?_id<CR>	~nn@NET-CONFIG id,net_ip,net_mask,gateway<CR><LF>	id – Network ID—the device network interface (if there are more than one). Counting is 0 based, meaning the control port is '0', additional ports are 1,2,3.... net_ip – Network IP net_mask – Network mask gateway – Network gateway	Get network configuration: #NET-CONFIG?_id<CR>

Function	Description	Syntax	Response	Parameters/Attributes	Example
NET-DHCP	Set DHCP mode. Only 1 is relevant for the mode value. To disable DHCP, the user must configure a static IP address for the device. Connecting Ethernet to devices with DHCP may take time in some networks. To connect with a randomly assigned DHCP IP, specify the device DNS name (if available) using the NAME command. You can also get an assigned IP by direct connection to USB or RS-232 protocol port, if available. For proper settings consult your network administrator. For Backward compatibility, the id parameter can be omitted. In this case, the Network ID, by default, is 0, which is the Ethernet control port.	#NET-DHCP netw_id,dhcp_state<CR>	~nn@NET-DHCP netw_id,dhcp_state<CR><LF>	netw_id – Network ID—the device network interface (if there are more than one). Counting is 0 based, meaning the control port is '0', additional ports are 1,2,3.... dhcp_state – 1 – Try to use DHCP. (If unavailable, use the IP address set by the factory or the net-ip command).	Enable DHCP mode for port 1, if available: #NET-DHCP_1,1<CR>
NET-DHCP?	Get DHCP mode. For Backward compatibility, the network ID can be omitted (it will be assigned the default value of 0, which is the Ethernet control port).	#NET-DHCP?_netw_id<CR>	~nn@NET-DHCP netw_id,dhcp_state<CR><LF>	netw_id – Network ID—the device network interface (if there are more than one). Counting is 0 based, meaning the control port is '0', additional ports are 1,2,3.... dhcp_state – 1 – Try to use DHCP. (If unavailable, use the IP address set by the factory or the net-ip command).	Get DHCP mode for port 1, if available: #NET-DHCP?_1<CR>
NET-DNS?	Get the ID and IP of the DNS name server. If dns_id is out of the defined DNS range, Error Code #3 (ERR_PARAMETER_OUT_OF_RANGE) is returned.	#NET-DNS? dns_id<CR>	~nn@NET-DNS dns_id,dns_ip<CR><LF>	dns_id : ID of the DNS name server to retrieve, indexing starts at "0" dns_ip : IP address of the DNS server.	Get DNS name server: #NET-DNS? <CR>
NET-GATE	Set a gateway IP. A network gateway connects the device to another network and may be over the Internet. Be careful of security issues. For proper settings consult your network administrator.	#NET-GATE ip_address<CR>	~nn@NET-GATE ip_address<CR><LF>	ip_address : (format) xxx.xxx.xxx.xxx	Set the gateway IP address to 192.168.0.1: #NET-GATE 192<CR>
NET-GATE?	Get the gateway IP.	#NET-GATE? <CR>	~nn@NET-GATE ip_address<CR><LF>	ip_address : (format) xxx.xxx.xxx.xxx	Get the gateway IP address: #NET-GATE? <CR>
NET-IP	Set the IP address. For proper settings consult your network administrator.	#NET-IP ip_address<CR>	~nn@NET-IP ip_address<CR><LF>	ip_address : (format) xxx.xxx.xxx.xxx	Set the IP address to 192.168.1.39: #NET-IP 192.168.1.39<CR>
NET-IP?	Get a network IP address. This is a UDP protocol only.	#NET-IP? <CR>	~nn@NET-IP net_ip<CR><LF>	net_ip – Network IP	Get network IP address: #NET-IP? <CR>
NET-MAC?	Get MAC address. For backward compatibility, the id parameter can be omitted. In this case, the Network ID, by default, is 0, which is the Ethernet control port.	#NET-MAC?_id<CR>	~nn@NET-MAC id,mac_address<CR><LF>	id – Network ID—the device network interface (if there are more than one). Counting is 0 based, meaning the control port is '0', additional ports are 1,2,3.... mac_address – Unique MAC address. Format: XX-XX-XX-XX-XX-XX where X is a hex digit	#NET-MAC?_id<CR>
NET-MASK	Set subnet mask. For proper settings consult your network administrator.	#NET-MASK net_mask<CR>	~nn@NET-MASK net_mask<CR><LF>	net_mask : (format) xxx.xxx.xxx.xxx	Set the subnet mask to 255.255.0.0: #NET-MASK 255.255.0.0<CR>
NET-MASK?	Get the subnet mask	#NET-MASK? <CR>	~nn@NET-MASK net_mask<CR><LF>	net_mask : (format) xxx.xxx.xxx.xxx	Get the subnet mask: #NET-MASK? <CR>
PORTS-LIST?	Get the port list of this machine. The response is returned in one line and terminates with <CR><LF>. The response format lists port IDs separated by commas.	#PORTS-LIST? <CR>	~nn@PORTS-LIST_<CR><LF>	port_list : list of ports [<port_id>,<port_id>,...] / example: ~01@PORTS-LIST [IN.USB_C.1,IN.HDMI.2,OUT.HDBT.1]	Get the ports list: #PORTS-LIST? <CR>
PROT-VER?	Get device protocol version.	#PROT-VER? <CR>	~nn@PROT-VER 3000:,version<CR><LF>	3000:: Prefix version : XX.XX where X is a decimal digit	Get the device protocol version: #PROT-VER? <CR>

Function	Description	Syntax	Response	Parameters/Attributes	Example
RESET	Reset device. To avoid locking the port due to a USB bug in Windows, disconnect USB connections immediately after running this command. If the port was locked, disconnect and reconnect the cable to reopen the port.	#RESET<CR>	~nn@RESET ok<CR><LF>		Reset the device: #RESET<CR>
SIGNAL?	Get input signal status.	#SIGNAL? in_index<CR>	~nn@SIGNAL in_index,status<CR><LF>	in_index : Number that indicates the specific input 1-N (N= the total number of inputs) status : Signal status according to signal validation 0 – Off 1 – On	Get the input signal lock status of IN 1: #SIGNAL? 1<CR>
SIGNALS-LIST?	Get signal ID list of this device. The response format lists signal IDs separated by commas. This is an Extended Protocol 3000 command.	#SIGNALS-LIST? <CR><LF>	~nn@SIGNALS-LIST [direction_type.port_format.port_label.signal_type.index,]<CR><LF>	The following attributes comprise the signal ID: direction_type – Direction of the port: IN – Input OUT – Output BOTH – Bi-directional (e.g. for RS-232) port_format – Type of signal on the port: HDMI HDBT ANALOG_AUDIO AMPLIFIED_AUDIO TOS SPDIF MIC RS-232 IR USB_A USB_B port_label – The port number as printed on the front or rear panel VIDEO AUDIO ARC RS232 IR USB signal_type – Signal ID attribute. index – Indicates a specific channel number when there are multiple channels of the same type	Get signal ID list: #SIGNALS-LIST?<CR>
SN?	Get device serial number.	#SN? <CR>	~nn@SN_serial_num<CR><LF>	serial_num – 14 decimal digits, factory assigned	Get the device serial number: #SN? <CR>
TIME	Set device time and date. The year must be 4 digits. The device does not validate the day of week from the date. Time format - 24 hours. Date format - Day, Month, Year.	#TIME day_of_week,date,data<CR>	~nn@TIME day_of_week,date,data<CR><LF>	day_of_week – One of {SUN,MON,TUE,WED,THU,FRI,SAT} date – Format: DD-MM-YYYY. data – Format: hh:mm:ss	Set device time and date to December 5, 2018 at 2:30pm: #TIME_mon_05-12-2018,14:30:00<CR>
TIME?	Get device time and date. The year must be 4 digits. Time format - 24 hours. Date format - Day, Month, Year.	#TIME? <CR>	~nn@TIME day_of_week,date,data<CR><LF>	day_of_week – One of {SUN,MON,TUE,WED,THU,FRI,SAT} date – Format: DD-MM-YYYY. data – Format: hh:mm:ss	Get device time and date: #TIME? <CR>
TIME-SRV	Set (NTP) time server. This command is needed for setting the UDP timeout for the current client list.	#TIME-SRV mode,time_server_ip,sync_hour<CR>	~nn@TIME-SRV mode,time_server_ip,sync_hour,server_status<CR><LF>	mode – On/Off 0 – Off 1 – On time_server_ip – Time server IP address sync_hour – Hour in day for time server sync server_status – On/Off	Set time server with IP address of 128.138.140.44 to ON: #TIME-SRV 1,128.138.140.44,0,1<CR>
TIME-SRV?	Get time server. This command is needed for setting UDP timeout for the current client list.	#TIME-SRV? <CR>	~nn@TIME-SRV mode,time_server_ip,sync_hour,server_status<CR><LF>	mode – On/Off 0 – Off 1 – On time_server_ip – Time server IP address sync_hour – Hour in day for time server sync server_status – On/Off	Get time server: #TIME-SRV? <CR>
TIME-ZONE	Set the device's time zone.	#TIME-ZONE timezone_str<CR>	~nn@TIME-ZONE timezone_str<CR><LF>	timezone_str : A string that identifies the relevant time zone. Available time zone strings can be listed using the TIME-ZONE-LIST? command.	Set time zone to London, England: #TIME-ZONE europe/london<CR>
TIME-ZONE?	Get the device's time zone.	#TIME-ZONE? <CR>	~nn@TIME-ZONE timezone_str<CR><LF>	timezone_str : A string that identifies the relevant time zone. Available time zone strings can be listed using the TIME-ZONE-LIST? command.	Get the device time zone: #TIME-ZONE? <CR>

Function	Description	Syntax	Response	Parameters/Attributes	Example
TIME-ZONE-LIST?	Get a list of time zones. Entries from the list can be set as the device time zone with the TIME-ZONE command.	#TIME-ZONE-LIST? <CR>	~nn@TIME-ZONE-LIST list<CR><LF>	list: List of available time zones, one per line	Get a list of available time zones: #TIME-ZONE-LIST? <CR>
TUNNELING-MODE	Set decoder tunneling mode enable / disable.	#TUNNELING-MODE enable/disable<CR>	~nn@TUNNELING-MODE <CR><LF>	enable/disable: decoder enable tunneling mode 1-0	set decoder tunneling mode enable #TUNNELING-MODE 1<CR>
TUNNELING-MODE?	Get decoder tunneling mode status.	#TUNNELING-MODE? <CR>	~nn@TUNNELING-MODE <CR><LF>	enable/disable: decoder enable tunneling mode 1-0	Get decoder tunneling mode #TUNNELING-MODE? <CR>
TXRX-MODE	Set tx/rx mode, this command will reset the device and restore factory defaults.	#TXRX-MODE hdbt_port_id,hdbt_mode<CR>	~nn@TXRX-MODE hdbt_port_id,hdbt_mode<CR><LF>	hdbt_port_id: HDBT port number 1 hdbt_mode: HDBT mode 0-Transmitter / 1-Receiver	set device in Transmitter mode #TXRX-MODE 1,0<CR>
TXRX-MODE?	Get tx/rx mode.	#TXRX-MODE? hdbt_port_id<CR>	~nn@TXRX-MODE hdbt_port_id,hdbt_mode<CR><LF>	hdbt_port_id: HDBT port number 1 hdbt_mode: HDBT mode 0-Transmitter / 1-Receiver	Get device tx/rx mode #TXRX-MODE? 1<CR>
UART	Set com port configuration. If Serial is configured when RS-485 is selected, the RS-485 UART port automatically changes. The command is backward compatible, meaning that if the extra parameters do not exist, FW goes to RS-232. Stop_bits 1.5 are only relevant for 5 data_bits.	#UART com_id,baud_rate,data_bits,parity,stop_bits_mode,serial_type,485_term<CR>	~nn@UART com_id,baud_rate,data_bits,parity,stop_bits_mode,serial_type,485_term<CR><LF>	com_id – 1 to n (machine dependent) baud_rate – 9600 - 115200 data_bits – 5-8 parity – Parity Type 0 – No 1 – Odd 2 – Even 3 – Mark 4 – Space stop_bits_mode – 1/1.5/2 serial_type – 232/485 0 – 232 1 – 485 485_term – 485 termination state 0 – disable 1 – enable (optional - this exists only when serial_type is 485)	Set baud rate to 9600, 8 data bits, parity to none and stop bit to 1: #UART 9600,8,node,1<CR>
UART?	Get com port configuration. The command is backward compatible, meaning that if the extra parameters do not exist, FW goes to RS-232. Stop_bits 1.5 is only relevant for 5 data_bits.	#UART?,com_id<CR>	~nn@UART com_id,baud_rate,data_bits,parity,stop_bits_mode,serial_type,485_term<CR><LF>	com_id – 1 to n (machine dependent) baud_rate – 9600 - 115200 data_bits – 5-8 parity – Parity Type 0 – No 1 – Odd 2 – Even 3 – Mark 4 – Space stop_bits_mode – 1/1.5/2 serial_type – 232/485 0 – 232 1 – 485 485_term – 485 termination state 0 – disable 1 – enable (optional - this exists only when serial_type is 485)	Set baud rate to 9600, 8 data bits, parity to none and stop bit to 1: #UART 1,9600,8,node,1<CR>
VERSION?	Get firmware version number.	#VERSION? <CR>	~nn@VERSION firmware_version<CR><LF>	firmware_version – XX.XX.XXXX where the digit groups are: major.minor.build version	Get the device firmware version number: #VERSION?<CR>
X-AUD-DESC?	Get audio signal info. This is an Extended Protocol 3000 command.	#X-AUD-DESC? <direction_type>.<port_format>.<port_index><CR>	~nn@X-AUD-DESC? <direction_type>.<port_format>.<port_label>.<signal_type>.<index>.<ch_tot,samp_rate,aud_format><CR><LF>	The following attributes comprise the signal ID: direction_type – Direction of the port: IN – Input OUT – Output BOTH – Bi-directional (e.g. for RS-232) port_format – Type of signal on the port: HDMI HDBT ANALOG_AUDIO AMPLIFIED_AUDIO TOS SPDIF MIC RS-232 IR USB_A USB_B port_index – The port number as printed on the front or rear panel. Port_label Signal_type - Signal ID attribute: VIDEO AUDIO ARC RS232 IR USB Index - Indicates a specific channel number when there are multiple channels of the same type. ch_tot – Total number of channels samp_rate – Sample rate aud format – audio format.	Get the audio signal info: #X-AUD-DESC? out.hDMI.1<CR>

Function	Description	Syntax	Response	Parameters/Attributes	Example
X-AUD-LVL	Set audio level of a specific signal. This is an Extended Protocol 3000 command.	#X-AUD-LVL <direction_type>.<port_format>.<port_index>.<signal_type>.<index>,<audio_level><CR>	~nn@X-AUD-LVL <direction_type>.<port_format>.<port_index>.<signal_type>.<index>,<audio_level><CR><LF>	The following attributes comprise the signal ID: <direction_type> – Direction of the port: IN – Input OUT – Output BOTH – Bi-directional (e.g. for RS-232) <port_format> – Type of signal on the port: HDMI HDBT ANALOG_AUDIO AMPLIFIED_AUDIO TOS SPDIF MIC RS-232 IR USB_A USB_B <port_index> – The port number as printed on the front or rear panel <signal_type> – Signal ID attribute: VIDEO AUDIO ARC RS232 IR USB <index> – Indicates a specific channel number when there are multiple channels of the same type audio_level – Audio level in dB (range between -60 to +30) depending of the ability of the product	Set the audio level of a specific signal to 10: #X-AUD-LVL in.analog_audio.5.audio.1,10<CR>
X-AUD-LVL?	Get the audio level of a specific signal.	#X-AUD-LVL? <direction_type>.<port_format>.<port_index>.<signal_type>.<index><CR>	~nn@X-AUD-LVL <direction_type>.<port_format>.<port_index>.<signal_type>.<index>,<audio_level><CR><LF>	The following attributes comprise the signal ID: <direction_type> – Direction of the port: IN – Input OUT – Output BOTH – Bi-directional (e.g. for RS-232) <port_format> – Type of signal on the port: HDMI HDBT ANALOG_AUDIO AMPLIFIED_AUDIO TOS SPDIF MIC RS-232 IR USB_A USB_B <port_index> – The port number as printed on the front or rear panel <signal_type> – Signal ID attribute: VIDEO AUDIO ARC RS232 IR USB <index> – Indicates a specific channel number when there are multiple channels of the same type audio_level – Audio level in dB (range between -60 to +30) depending of the ability of the product	Get the audio level of a specific signal: #X-AUD-LVL? out.analog_audio.1.audio.1<CR>
X-MUTE	Set mute ON/OFF on a specific signal. This command is designed to Mute a Signal. This means that it could be applicable on any type of signal. Could be audio, video and maybe IR, USB or data if this capability is supported by the product.	#X-MUTE <direction_type>.<port_format>.<port_index>.<signal_type>.<index>,<state><CR>	~nn@ X-MUTE <direction_type>.<port_format>.<port_index>.<signal_type>.<index>,<state><CR><LF>	<direction_type> – Direction of the port: { IN – Input ; OUT – Output; BOTH – Bi-directional } <port_format> – Type of signal on the port: { HDMI,USB_C,ANALOG_AUDIO } <port_index> – The port number as printed on the front or rear panel <signal_type> – Signal ID attribute: { VIDEO, AUDIO } <index> – Indicates a specific channel number when there are multiple channels of the same type state – OFF/ON (not case sensitive)	Mute the video on HDMI OUT 1: #X-MUTE_out.hdmi.1.video.1,on<CR>

Function	Description	Syntax	Response	Parameters/Attributes	Example
X-MUTE?	Get mute ON/OFF on a specific signal.	#X-MUTE? <direction_type>.<port_format>.<port_index>.<signal_type>.<index><CR>	~nn@X-MUTE <direction_type>.<port_format>.<port_index>.<signal_type>.<index>,state<CR><LF>	<direction_type> – Direction of the port: { IN – Input ; OUT – Output; BOTH – Bi-directional } <port_format> – Type of signal on the port: { HDMI,USB_C,ANALOG_AUDIO } <port_index> – The port number as printed on the front or rear panel <signal_type> – Signal ID attribute: { VIDEO, AUDIO } <index> – Indicates a specific channel number when there are multiple channels of the same type state – OFF/ON (not case sensitive)	Get the mute the video on HDMI OUT 1: #X-MUTE?_out.hdmi.1.video.1<CR>
X-ROUTE	Send routing command. It is recommended to use the command #SIGNALS-LIST to get the list of all the signal IDs which can be used in this command. Video 1 is the default port in this command and is implied even if not written: #X-ROUTE out.sdi.5.in.sdi.1<CR> is interpreted as: #X-ROUTE out.sdi.5.video.1.in.sdi.1.video.1<CR> This is an Extended Protocol 3000 command. Brackets '[' and ']' are reserved Protocol 3000 characters that define a list of parameters as in [a,b,c,d].	#X-ROUTE [<direction_type1>.<port_type1>.<port_index1>.<signal_type1>.<index1>,...],<direction_type2>.<port_type2>.<port_index2>.<signal_type2>.<index2><CR>	~nn@X-ROUTE [<direction_type1>.<port_type1>.<port_index1>.<signal_type1>.<index1>,...],<direction_type2>.<port_type2>.<port_index2>.<signal_type2>.<index2><CR><LF>	The following attributes comprise the signal ID: <direction_type> – Direction of the port: IN – Input OUT – Output BOTH – Bi-directional (e.g. for RS-232) <port_type> – Type of signal on the port: HDMI HDBT ANALOG_AUDIO AMPLIFIED_AUDIO TOS SPDIF MIC RS-232 IR USB_A USB_B STREAM DANTE <port_index> – The port number as printed on the front or rear panel <signal_type> – Signal ID attribute: VIDEO AUDIO ARC RS232 IR USB <index> – Indicates a specific channel number when there are multiple channels of the same type.	Route HDMI IN 2 to HDMI OUT 3: #X-ROUTE out.hdmi.3.video.1.in.hdmi.2.video.1<CR> Route an ARC audio signal to HDBT input #1 from HDMI output #1: #X-ROUTE in.hdbt.1.arc.1.out.hdmi.1.arc.1<CR> Route audio of hdmi.1.audio.1 signal to hdmi output, analog, and dante: #X-ROUTE [out.hdmi.1.audio.1.out.analog_audio.1.audio.1.out.dante.1.audio.1]_in.hdmi.1.audio.1<CR>
X-ROUTE?	Get routing status. It is recommended to use the command #SIGNALS-LIST to get the list of all signal IDs available in the system and which can be used in this command. VIDEO.1 are the default <signal_type> and <index> in this command and are implied even if not written: #X-ROUTE out.sdi.5.in.sdi.1<CR> is interpreted as: #X-ROUTE out.sdi.5.video.1.in.sdi.1.video.1<CR> This is an Extended Protocol 3000 command.	#X-ROUTE? <direction_type1>.<port_type1>.<port_index1>.<signal_type1>.<index1><CR>	~nn@X-ROUTE <direction_type1>.<port_type1>.<port_index1>.<signal_type1>.<index1>,<direction_type2>.<port_type2>.<port_index2>.<signal_type2>.<index2><CR><LF>	The following attributes comprise the signal ID: <direction_type> – Direction of the port: IN – Input OUT – Output BOTH – Bi-directional (e.g. for RS-232) <port_format> – Type of signal on the port: HDMI HDBT ANALOG_AUDIO AMPLIFIED_AUDIO TOS SPDIF MIC RS-232 IR USB_A USB_B USB_C <port_index> – The port number as printed on the front or rear panel <signal_type> – Signal ID attribute: VIDEO AUDIO ARC RS232 IR USB AV_TEST_PATTERN <index> – Indicates a specific channel number when there are multiple channels of the same type.	Get the routing status: #X-ROUTE? out.hdmi.5.video.1<CR>

Result and Error Codes

Syntax

In case of an error, the device responds with an error message. The error message syntax:

- **~NN@ERR XXX<CR><LF>** – when general error, no specific command
- **~NN@CMD ERR XXX<CR><LF>** – for specific command
- **NN** – machine number of device, default = 01
- **XXX** – error code

Error Codes

Error Name	Error Code	Description
P3K_NO_ERROR	0	No error
ERR_PROTOCOL_SYNTAX	1	Protocol syntax
ERR_COMMAND_NOT_AVAILABLE	2	Command not available
ERR_PARAMETER_OUT_OF_RANGE	3	Parameter out of range
ERR_UNAUTHORIZED_ACCESS	4	Unauthorized access
ERR_INTERNAL_FW_ERROR	5	Internal FW error
ERR_BUSY	6	Protocol busy
ERR_WRONG_CRC	7	Wrong CRC
ERR_TIMEDOUT	8	Timeout
ERR_RESERVED	9	(Reserved)
ERR_FW_NOT_ENOUGH_SPACE	10	Not enough space for data (firmware, FPGA...)
ERR_FS_NOT_ENOUGH_SPACE	11	Not enough space – file system
ERR_FS_FILE_NOT_EXISTS	12	File does not exist
ERR_FS_FILE_CANT_CREATED	13	File can't be created
ERR_FS_FILE_CANT_OPEN	14	File can't open
ERR_FEATURE_NOT_SUPPORTED	15	Feature is not supported
ERR_RESERVED_2	16	(Reserved)
ERR_RESERVED_3	17	(Reserved)
ERR_RESERVED_4	18	(Reserved)
ERR_RESERVED_5	19	(Reserved)
ERR_RESERVED_6	20	(Reserved)
ERR_PACKET_CRC	21	Packet CRC error
ERR_PACKET_MISSED	22	Packet number isn't expected (missing packet)
ERR_PACKET_SIZE	23	Packet size is wrong
ERR_RESERVED_7	24	(Reserved)
ERR_RESERVED_8	25	(Reserved)
ERR_RESERVED_9	26	(Reserved)
ERR_RESERVED_10	27	(Reserved)
ERR_RESERVED_11	28	(Reserved)
ERR_RESERVED_12	29	(Reserved)
ERR_EDID_CORRUPTED	30	EDID corrupted
ERR_NON_LISTED	31	Device specific errors
ERR_SAME_CRC	32	File has the same CRC – not changed
ERR_WRONG_MODE	33	Wrong operation mode
ERR_NOT_CONFIGURED	34	Device/chip was not initialized

The warranty obligations of Kramer Electronics Inc. ("Kramer Electronics") for this product are limited to the terms set forth below:

What is Covered

This limited warranty covers defects in materials and workmanship in this product.

What is Not Covered

This limited warranty does not cover any damage, deterioration or malfunction resulting from any alteration, modification, improper or unreasonable use or maintenance, misuse, abuse, accident, neglect, exposure to excess moisture, fire, improper packing and shipping (such claims must be presented to the carrier), lightning, power surges, or other acts of nature. This limited warranty does not cover any damage, deterioration or malfunction resulting from the installation or removal of this product from any installation, any unauthorized tampering with this product, any repairs attempted by anyone unauthorized by Kramer Electronics to make such repairs, or any other cause which does not relate directly to a defect in materials and/or workmanship of this product. This limited warranty does not cover cartons, equipment enclosures, cables or accessories used in conjunction with this product.

Without limiting any other exclusion herein, Kramer Electronics does not warrant that the product covered hereby, including, without limitation, the technology and/or integrated circuit(s) included in the product, will not become obsolete or that such items are or will remain compatible with any other product or technology with which the product may be used.

How Long this Coverage Lasts

The standard limited warranty for Kramer products is seven (7) years from the date of original purchase, with the following exceptions:

1. All Kramer VIA hardware products are covered by a standard three (3) year warranty for the VIA hardware and a standard three (3) year warranty for firmware and software updates; all Kramer VIA accessories, adapters, tags, and dongles are covered by a standard one (1) year warranty.
2. Kramer fiber optic cables, adapter-size fiber optic extenders, pluggable optical modules, active cables, cable retractors, ring mounted adapters, portable power chargers, Kramer speakers, and Kramer touch panels are covered by a standard one (1) year warranty. Kramer 7-inch touch panels purchased on or after April 1st, 2020 are covered by a standard two (2) year warranty.
3. All Kramer Calibre products, all Kramer Minicom digital signage products, all HighSecLabs products, all streaming, and all wireless products are covered by a standard three (3) year warranty.
4. All Sierra Video MultiViewers are covered by a standard five (5) year warranty.
5. Sierra switchers & control panels are covered by a standard seven (7) year warranty (excluding power supplies and fans that are covered for three (3) years).
6. K-Touch software is covered by a standard one (1) year warranty for software updates.
7. All Kramer passive cables are covered by a lifetime warranty.

Who is Covered

Only the original purchaser of this product is covered under this limited warranty. This limited warranty is not transferable to subsequent purchasers or owners of this product.

What Kramer Electronics Will Do

Kramer Electronics will, at its sole option, provide one of the following three remedies to whatever extent it shall deem necessary to satisfy a proper claim under this limited warranty:

1. Elect to repair or facilitate the repair of any defective parts within a reasonable period of time, free of any charge for the necessary parts and labor to complete the repair and restore this product to its proper operating condition. Kramer Electronics will also pay the shipping costs necessary to return this product once the repair is complete.
2. Replace this product with a direct replacement or with a similar product deemed by Kramer Electronics to perform substantially the same function as the original product. If a direct or similar replacement product is supplied, the original product's end warranty date remains unchanged and is transferred to the replacement product.
3. Issue a refund of the original purchase price less depreciation to be determined based on the age of the product at the time remedy is sought under this limited warranty.

What Kramer Electronics Will Not Do Under This Limited Warranty

If this product is returned to Kramer Electronics or the authorized dealer from which it was purchased or any other party authorized to repair Kramer Electronics products, this product must be insured during shipment, with the insurance and shipping charges prepaid by you. If this product is returned uninsured, you assume all risks of loss or damage during shipment. Kramer Electronics will not be responsible for any costs related to the removal or re-installation of this product from or into any installation. Kramer Electronics will not be responsible for any costs related to any setting up this product, any adjustment of user controls or any programming required for a specific installation of this product.

How to Obtain a Remedy Under This Limited Warranty

To obtain a remedy under this limited warranty, you must contact either the authorized Kramer Electronics reseller from whom you purchased this product or the Kramer Electronics office nearest you. For a list of authorized Kramer Electronics resellers and/or Kramer Electronics authorized service providers, visit our web site at www.kramerav.com or contact the Kramer Electronics office nearest you.

In order to pursue any remedy under this limited warranty, you must possess an original, dated receipt as proof of purchase from an authorized Kramer Electronics reseller. If this product is returned under this limited warranty, a return authorization number, obtained from Kramer Electronics, will be required (RMA number).

You may also be directed to an authorized reseller or a person authorized by Kramer Electronics to repair the product.

If it is decided that this product should be returned directly to Kramer Electronics, this product should be properly packed, preferably in the original carton, for shipping. Cartons not bearing a return authorization number will be refused.

Limitation of Liability

THE MAXIMUM LIABILITY OF KRAMER ELECTRONICS UNDER THIS LIMITED WARRANTY SHALL NOT EXCEED THE ACTUAL PURCHASE PRICE PAID FOR THE PRODUCT. TO THE MAXIMUM EXTENT PERMITTED BY LAW, KRAMER ELECTRONICS IS NOT RESPONSIBLE FOR DIRECT, SPECIAL, INCIDENTAL OR CONSEQUENTIAL DAMAGES RESULTING FROM ANY BREACH OF WARRANTY OR CONDITION, OR UNDER ANY OTHER LEGAL THEORY. Some countries, districts or states do not allow the exclusion or limitation of relief, special, incidental, consequential or indirect damages, or the limitation of liability to specified amounts, so the above limitations or exclusions may not apply to you.

Exclusive Remedy

TO THE MAXIMUM EXTENT PERMITTED BY LAW, THIS LIMITED WARRANTY AND THE REMEDIES SET FORTH ABOVE ARE EXCLUSIVE AND IN LIEU OF ALL OTHER WARRANTIES, REMEDIES AND CONDITIONS, WHETHER ORAL OR WRITTEN, EXPRESS OR IMPLIED. TO THE MAXIMUM EXTENT PERMITTED BY LAW, KRAMER ELECTRONICS SPECIFICALLY DISCLAIMS ANY AND ALL IMPLIED WARRANTIES, INCLUDING, WITHOUT LIMITATION, WARRANTIES OF MERCHANTABILITY AND FITNESS FOR A PARTICULAR PURPOSE. IF KRAMER ELECTRONICS CANNOT LAWFULLY DISCLAIM OR EXCLUDE IMPLIED WARRANTIES UNDER APPLICABLE LAW, THEN ALL IMPLIED WARRANTIES COVERING THIS PRODUCT, INCLUDING WARRANTIES OF MERCHANTABILITY AND FITNESS FOR A PARTICULAR PURPOSE, SHALL APPLY TO THIS PRODUCT AS PROVIDED UNDER APPLICABLE LAW. IF ANY PRODUCT TO WHICH THIS LIMITED WARRANTY APPLIES IS A "CONSUMER PRODUCT" UNDER THE MAGNUSON-MOSS WARRANTY ACT (15 U.S.C.A. §2301, ET SEQ.) OR OTHER APPLICABLE LAW, THE FOREGOING DISCLAIMER OF IMPLIED WARRANTIES SHALL NOT APPLY TO YOU, AND ALL IMPLIED WARRANTIES ON THIS PRODUCT, INCLUDING WARRANTIES OF MERCHANTABILITY AND FITNESS FOR THE PARTICULAR PURPOSE, SHALL APPLY AS PROVIDED UNDER APPLICABLE LAW.

Other Conditions

This limited warranty gives you specific legal rights, and you may have other rights which vary from country to country or state to state.

This limited warranty is void if (i) the label bearing the serial number of this product has been removed or defaced, (ii) the product is not distributed by Kramer Electronics or (iii) this product is not purchased from an authorized Kramer Electronics reseller. If you are unsure whether a reseller is an authorized Kramer Electronics reseller, visit our web site at www.kramerav.com or contact a Kramer Electronics office from the list at the end of this document.

Your rights under this limited warranty are not diminished if you do not complete and return the product registration form or complete and submit the online product registration form. Kramer Electronics thanks you for purchasing a Kramer Electronics product. We hope it will give you years of satisfaction.



HDMI™
HIGH-DEFINITION MULTIMEDIA INTERFACE



P/N:



2900-301659

Rev:

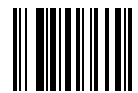

1



SAFETY WARNING

Disconnect the unit from the power supply before opening and servicing

For the latest information on our products and a list of Kramer distributors, visit our website where updates to this user manual may be found.

We welcome your questions, comments, and feedback.

The terms HDMI, HDMI High-Definition Multimedia Interface, and the HDMI Logo are trademarks or registered trademarks of HDMI Licensing Administrator, Inc. All brand names, product names, and trademarks are the property of their respective owners.