

Canon

RF

16-28mm F2.8 IS STM

Instructions

ENG

Thank you for purchasing a Canon product.

Canon RF16-28mm F2.8 IS STM is a wide-angle zoom lens for use with EOS R series cameras.

- “IS” stands for Image Stabilizer.
- “STM” stands for Stepping Motor.

Conventions used in these instructions



Warning to prevent lens or camera malfunction or damage.



Supplementary notes on using the lens and taking pictures.

Camera Firmware and Camera Applications

Please use the latest versions of firmware and applications with the camera in use. For details on whether the firmware and applications in use are the latest version or not, and for details on updating them, please check the Canon website.



If the camera's* firmware is not a compatible version, the following limitations will apply.

- Magnified view functionality is not available.
- In some cases, the camera malfunction may occur.

* Applies to the following camera models:
EOS R and EOS RP

Safety Precautions

Precautions to ensure that the camera is used safely. Read these precautions thoroughly. Make sure all details are observed in order to prevent risks and injury to the user and other people.



Warning

Details pertaining to risks that may result in death or serious injury.

- **Do not look directly at the sun or other strong light sources through a lens.** This may result in loss of sight.
- **Do not leave a lens in the sun without the lens cap attached.** The lens may concentrate entering sunlight and cause a malfunction or fire.



Caution

Details pertaining to risks that may result in injury or damage to other objects.

- **Do not leave the product in places exposed to extremely high or low temperatures.** The product may cause burns or injury when touched.

General Precautions

Handling Precautions

- Do not leave the product in excessive heat such as in a car in direct sunlight. High temperatures can cause the product to malfunction.
- If the lens is taken from a cold environment into a warm one, condensation may develop on the lens surface and internal parts. To prevent condensation in this case, first put the lens into an airtight plastic bag before taking it from a cold to warm environment. Then take out the lens after it has warmed gradually. Do the same when taking the lens from a warm environment into a cold one.
- In order to optimize aperture control, there are occasions in which the aperture blades will move during zooming, even when the aperture value is set for aperture-priority AE or manual exposure, etc.
- Please also read any lens related handling precautions listed in your camera's instruction manual.

This device complies with Part 15 of the FCC Rules.

Operation is subject to the following two conditions: (1) This device may not cause harmful interference, and (2) this device must accept any interference received, including interference that may cause undesired operation.

Do not make any changes or modifications to the equipment unless otherwise specified in the instructions. If such changes or modifications should be made, you could be required to stop operation of the equipment.

This equipment has been tested and found to comply with the limits for a class B digital device, pursuant to part 15 of the FCC Rules. These limits are designed to provide reasonable protection against harmful interference in a residential installation. This equipment generates, uses and can radiate radio frequency energy and, if not installed and used in accordance with the instructions, may cause harmful interference to radio communications.

However, there is no guarantee that interference will not occur in a particular installation. If this equipment does cause harmful interference to radio or television reception, which can be determined by turning the equipment off and on, the user is encouraged to try to correct the interference by one or more of the following measures:

- Reorient or relocate the receiving antenna.
- Increase the separation between the equipment and receiver.
- Connect the equipment into an outlet on a circuit different from that to which the receiver is connected.
- Consult the dealer or an experienced radio/TV technician for help.

Nomenclature

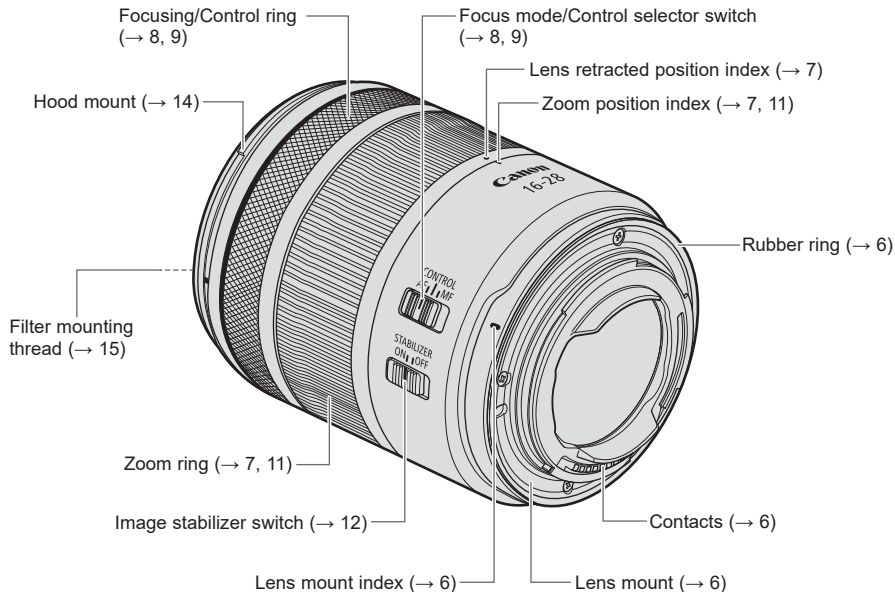

- For detailed information, reference page numbers are provided in parentheses (→ **).

1. Attaching and Detaching the Lens

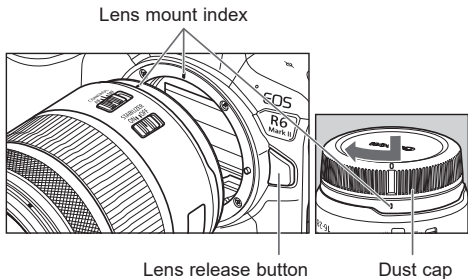

Attaching the Lens

Align the lens mount indexes of the lens and camera, and turn the lens clockwise until you hear a click.

Detaching the Lens

Turn the lens counterclockwise while pressing the camera's lens release button. Detach the lens once it has stopped turning.

Please refer to the camera's instructions for details.



- Set the camera's power switch to OFF when attaching or detaching the lens.
- Attach the lens cap before detaching the lens from the camera.
- After detaching the lens, place the lens with the rear end up and attach the dust cap to prevent the lens surface and contacts from getting scratched. Make sure the lens and dust cap mount indexes are aligned when attaching the dust cap.
- Contacts that are scratched, soiled, or have fingerprints on them may result in faulty connections or corrosion, which may lead to malfunctions. If the contacts get soiled, clean them with a soft cloth.
- The lens mount has a rubber ring to improve dust-resistance and water-resistance performance. This rubber ring may cause friction marks to appear around the camera's lens mount, although this will have no effect on usage.



- Rubber rings can be replaced at a Canon Service Center. (chargeable)

2. Shooting Preparations and Retracting Lens

The lens is fitted with a retraction mechanism.

This enables the length of the lens to be shortened in comparison to when shooting.

Shooting is not possible when the lens is stored.

Observe the following procedure to set the lens in the position for shooting.

Preparations from Retraction to Shooting

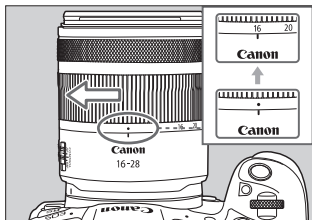

Rotate the zoom ring in the direction of the white arrow until you hear a click to set the lens in the preparatory shooting position.

- ⚠ If the lens retraction position indicator is aligned with the zoom indicator, add slight pressure to rotate the zoom ring in the direction of the arrow.

Retracting Lens

- 1 Rotate the zoom ring from the shooting position in the opposite direction to the white arrow.
- 2 Continue rotating after it exceeds the wide-angle position (16 mm).
- 3 Rotate it to the end to align the lens retraction position indicator with the zoom indicator and store it.

- ⚠ Please be careful not to let your fingers get caught in between the lens portion that extends and the lens body when retracting.

3. Setting the Focus Mode

Focus mode/control selector switch

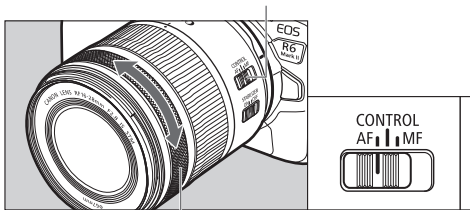

Focusing/Control ring

To shoot in autofocus (AF) mode, set the focus mode/control selector switch to AF.

To use only manual focusing (MF), set the focus mode/control selector switch to MF, and focus by turning the focusing ring.



- Quickly turning the focusing ring (focusing/control ring) may result in delayed focus.



- The lens' focusing ring (focusing/control ring) is electronic.
- This lens supports both lens electronic MF and electronic full-time MF.
- When movie recording, the AF speed will be slower than the still photo shooting mode. It is possible to adjust the AF speed on the camera by setting Movie Servo AF to [Enable].

Please refer to the camera's instructions for details.

4. Focusing/Control ring

The focusing/control ring can be used as either a focusing ring or a control ring.

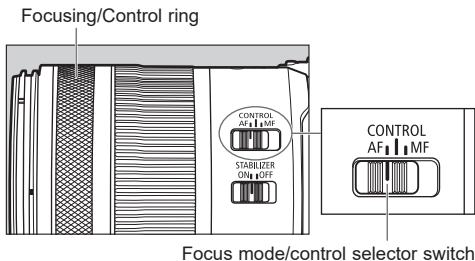

Use as a Focusing Ring

Set the focus mode/control selector switch to AF or MF.

Setting it to AF will change the focus mode to autofocus (AF). Table*1

Setting it to MF will change the focus mode to manual focus (MF). Table*2

Table: List of Focus Mode and Focusing/Control Ring Functions Using the Focus Mode/Control Selector Switch

	Focus mode/ Control selector switch		
	*1 AF	*3 CONTROL	*2 MF
Focus mode	AF	*4 AF/ *5 MF	MF
Focusing/ control ring functions	Focusing ring	Control ring	Focusing ring

Use as a Control Ring

Set the focus mode/control selector switch to CONTROL. Table*3

Set the control ring function using the camera's menu. The control ring can be assigned the functions that are commonly used with cameras, such as shutter speed and aperture settings. Please refer to the camera's instructions for details on how to use the control ring.

Focusing/Control ring



- Quickly turning the focusing ring (focusing/control ring) may result in delayed focus.
- Setting the focus mode/control selector switch to CONTROL will fix the focus mode as AF. Table*4
- As focusing/control ring functions are accessed from the control ring at this time, manual focus will not be available even if full-time manual focus operation is enabled or set to ON on the camera.
- Depending on the camera used, it is possible to switch the focus mode to MF on the camera. Table*5

However, as focusing/control ring functions are accessed from the control ring, manual focus will not be available. This means that the focus position will remain what it was when the switch was moved to CONTROL.

Please refer to the camera's instructions for details.



- The lens' focusing ring (focusing/control ring) is electronic.
- This lens supports both lens electronic MF and electronic full-time MF.
- When movie recording, the AF speed will be slower than the still photo shooting mode. It is possible to adjust the AF speed on the camera by setting Movie Servo AF to [Enable].

Please refer to the camera's instructions for details.

5. Zooming

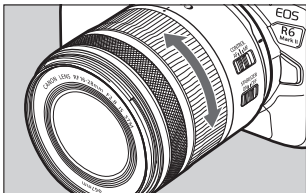

To zoom, turn the zoom ring.

Minimum focusing distance:

The minimum focusing distance differs depending on the focal length.

Focal length	Minimum focusing distance	Magnification
16 mm	0.25 m/0.82 ft.	0.11x
20 mm	0.22 m/0.72 ft.	0.16x
24 mm	0.21 m/0.69 ft.	0.21x
28 mm	0.2 m/0.66 ft.	0.26x



- Be sure to finish zooming before focusing. Zooming after focusing can affect the focus.
- Once a close-up subject is in focus, zooming may cause the subject to come out of focus. In this instance, move back from the subject and refocus.
- Blurring may temporarily occur if the zoom ring is quickly turned.
- Please be careful not to let your fingers get caught in between the lens portion that extends and the lens body when zooming.

6. Image Stabilizer

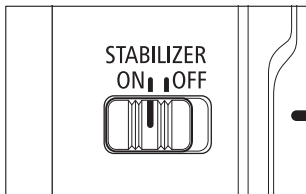

Set the image stabilizer switch to ON when you want to use the Image Stabilizer.

- This function provides image stabilization appropriate for shooting conditions (such as shooting still subjects and panning shots).
- The coordinated control will work in combination with cameras with in-body Image Stabilizer.
- Supports peripheral control** using coordinated control with the camera*.
- Set the image stabilizer switch to OFF when you are not going to use the Image Stabilizer.

- ⓘ ● The Image Stabilizer cannot compensate for a blurred shot caused by a subject that moved.
- The Image Stabilizer may not be fully effective if you shoot from a violently shaking vehicle or other transportation.
- When using a tripod, the Image Stabilizer might not be fully effective or it might be better to set the image stabilizer switch to OFF, depending on the type of tripod and where the tripod is located, as well as on the camera's settings such as shutter speed.
- Even with a monopod, the Image Stabilizer will be as effective as during hand-held shooting. However, depending on the shooting conditions, there are cases in which the Image Stabilizer effect may be less effective.

* Please use the latest version of firmware with the camera.

For supported cameras, details on whether the firmware is the latest version, and how to update, please check the Canon website.

**In addition to normal control, this reduced changes of the distortion around the screen periphery that often happen due to shaking with wide-angle lenses.

Image Stabilizer

The Image Stabilizer for this lens is suited to hand-held shots in the following conditions.



- In semi-darkened areas such as indoors or outdoors at night.
- In locations where the flash cannot be used, such as art museums and theater stages.
- In situations where your footing is uncertain.
- In situations where fast shutter speed settings cannot be used.



- Panning shots of vehicles, trains, etc.
It compensates for vertical camera shake during panning shots in a horizontal direction, and compensates for horizontal camera shake during panning shots in a vertical direction.

7. Hood (Sold separately)

The custom lens hood reduces unwanted light that causes flare and ghosting and protects the front of the lens from rain, snow, and dust.

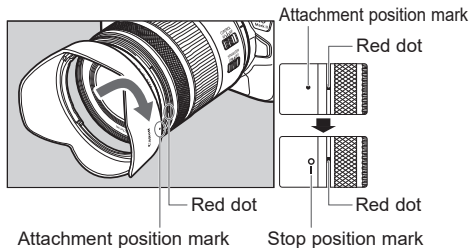

Attaching the Hood

Align the red attachment position mark on the hood with the red dot on the front of the lens, and then turn the hood in the direction of the arrow until the red dot on the lens is aligned with the stop position on the hood and the hood is firmly attached.

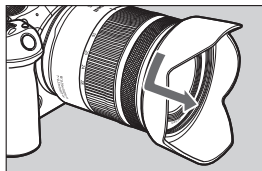

Detaching the Hood

Rotate the hood in the direction of the arrow until the hood attachment position mark is aligned with the red indicator on the front of the lens to remove it.

The hood can be reverse-mounted on the lens for storage.

- If the hood is not attached properly, vignetting (darkening of the perimeter of the picture) may occur.
- Grasp and turn the base of the hood when attaching and detaching it. There are cases in which it may become deformed if the hood is turned with it grasped near to the rim.

8. Filters (Sold separately)

You can attach filters ($\Phi 67$) to the filter mounting thread on the front of the lens.

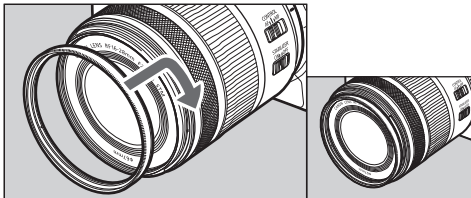

- Only one filter may be attached.
- If you need a polarizing filter, use the Canon Circular Polarizing Filter PL-C B.
- Detach the hood when adjusting the polarizing filter.

Specifications

Focal Length/Aperture	16-28mm f/2.8
Lens Construction	13 groups, 16 elements
Maximum Aperture	f/2.8
Minimum Aperture	f/22
Angle of View	Horizontal: 98° - 65°, Vertical: 74°10' - 46°, Diagonal: 108°10' - 75°
Min. Focusing Distance	0.2 m/0.66 ft. (at 28 mm)
Max. Magnification	0.26x (at 28 mm)
Field of View	Approx. 318 x 212 - 138 x 92 mm/12.52 x 8.35 - 5.43 x 3.62 in.
Filter Diameter	67 mm
Max. Diameter and Length	Approx. 76.5 x 91 mm/3.01 x 3.58 in. (when lens is stored)
Weight	Approx. 445 g/15.70 oz.
Hood	EW-73E (Sold separately)
Lens Cap	E-67 II*
Lens Dust Cap	Lens Dust Cap RF*
Case	LP1116 (Sold separately)

Specifications

- The lens length is measured from the lens mount surface to the front end of the lens.
Add 24.2 mm/0.95 in. when including the lens cap and dust cap.
- The maximum diameter, length and weight listed are for the lens itself only.
- * comes included with the lens, but can also be purchased separately.
- Close-up Lens 250D/500D cannot be attached because there is no size that fits the lens.
- You cannot use extenders.
- Multiple exposure shooting is not possible when using this lens on certain cameras**.
** EOS R, RP, Ra, R5, R6
- There are cases in which using the zoom function during continuous shooting may result in conspicuous image distortion.
- All data listed is measured according to Canon standards.
- Photos shown are for illustration purposes only.
- Product specifications and appearance are subject to change without notice.

Canon