

# SmallRig

**EN** User manual

**CN** 用户手册

**DE** Bedienungsanleitung

**FR** Manuel d'utilisation

**IT** Manuale dell'utente

**ES** Manual del usuario

**PT** Manual do usuário

**NL** Gebruiksaanwijzing

**SE** Gebruikershandleiding

**KR** 운영 지침



**Model / 型号: RC 60C**

## RGB LED Video Light

[ with Powerbank Clamp Edition / Lite Edition ]

RGB 摄影补光灯 (续航版 / 青春版)



# CONTENTS

## EN

Important Reminder .....	2
Product Overview .....	3
Installations.....	4-5
Product Operation .....	6-9
Product Specifications.....	10

## CN

重要提示 .....	11
产品介绍 .....	12
安装步骤 .....	13-14
产品操作 .....	15-18
产品参数 .....	19

## DE

Wichtige Hinweise .....	20
Produktbeschreibung.....	21
Installationen.....	22-23
Produktbetrieb .....	24-27
Produktparameter.....	28

## FR

Remarques importantes.....	29
Aperçu du produit .....	30
Installations .....	31-32
Fonctionnement du produit.....	33-36
Spécifications .....	37

## IT

Promemoria Importante.....	38
Panoramica del prodotto.....	39
Installazioni .....	40-41
Operazione del Prodotto .....	42-45
Parametri del prodotto .....	46

**ES**

Importante aviso .....	47
Resumen del producto .....	48
Instalaciones .....	49-50
Operación del Producto .....	51-54
Parámetros del producto .....	55

**PT**

Importante Aviso .....	56
Visão geral do produto .....	57
Instalações .....	58-59
Operação do Produto .....	60-63
Especificações do Produto .....	64

**NL**

Belangrijke instructies .....	65
Productoverzicht .....	66
Installaties .....	67-68
Productbediening .....	69-72
Productparameters .....	73

**SE**

Viktig prompt .....	74
Produktöversikt .....	75
Installation .....	76-77
Produktoperation .....	78-81
Produktparametrar .....	82

**KR**

중요한 팁 .....	83
제품 소개 .....	84
설치 설명서 .....	85-86
제품 작동 .....	87-90
규격 사양 .....	91

## Important Reminder

Thank you for choosing SmallRig products.

1. Please read the user manual carefully before using this product.
2. Please pay attention to all warnings and follow all instructions in the user manual.
3. For children, please use it under adult guidance.
4. Please remove the protective cover of the COB lamp bead before use.
5. After the light is used, the COB and panel , the top and bottom are high temperature areas. Before cooling the device, avoid high temperature areas. For your safety and health, Do not block the heat dissipation hole when using the device, and do not look directly at the device for a long time when it is working.
6. Ensure that the equipment is completely cooled before storage . After the device has cooled, place in the appropriate position of the storage bag.
7. In order to ensure the normal operation of the equipment, it is recommended to store it in a cool, dry and clean environment. Do not store the device near damp, liquid, or other flammable or volatile solvents. Avoid damaging the equipment.
8. If you need to clean the surface of the device, use a dry soft cloth . Before cleaning and servicing, be sure to unplug the power adapter and cable.
9. To reduce the risk of electric shock, do not immerse the device in water or other liquids.
10. In order to reduce the risk of electric shock, do not disassemble the device without permission. If the device fails and needs maintenance, please consult the relevant purchase channels and be handled by professional maintenance personnel. Non-standard assembly and maintenance may have security risks, unauthorized disassembly is prohibited.
11. Use of accessories not recommended by SmallRig may cause hazards such as fire or electric shock. Please refer to the accessories or according to the specifications provided by SmallRig, and used accessories certified by qualified manufacturer.



Do not disassemble the product. If you suspect any problem with the product, please contact the purchasing channel and apply for after-sales service.

## In the Box (4808 Lite Edition)

RC 60C RGB LED Video Light	× 1	User Manual	× 1
mini Reflector	× 1	Protective Cover	× 1
3-meter USB-C to USB-C PD Charging Cable	× 1		

## In the Box (4810 with Powerbank Clamp Edition)

RC 60C RGB LED Video Light	× 1	User Manual	× 1
mini Reflector	× 1	Protective Cover	× 1
Light Stand Adaptor	× 1	Carrying Bag	× 1
Powerbank Clamp	× 1	Handle	× 1
20cm C to C USB PD Charging Cable	× 1		
3-meter USB-C to USB-C PD Charging Cable	× 1		

## Product Introduction

Modifier Release  
Latch

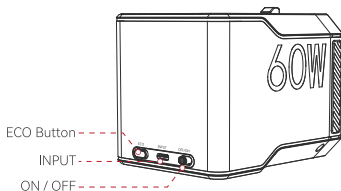
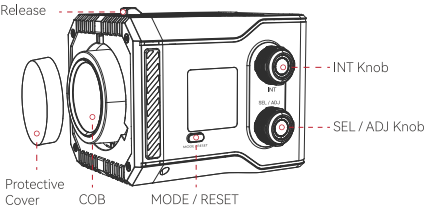

## Installations

1. **Remove or insert Silicone Cover:** Follow the arrows to remove / insert the silicone cover.

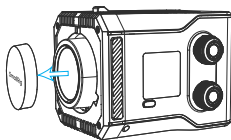

2. **Installation and Removal for Mini-Mount Modifiers:** Take mini reflector as an example. Align the mini-mount reflector with the mini-mount port on the front cover of the light. Rotate counter-clockwise to install. Push the Mini modifiers Release Button and rotate the mini reflector clockwise to remove.

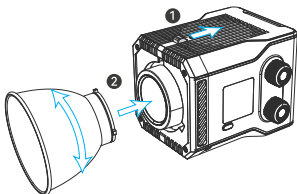

3. **Mounting the Light to a Light Stand:** First, connect the light stand adaptor to the RC 60C using the 1/4" threaded hole on the bottom. Then, install the light stand adaptor onto the light stand and adjust the angle of the RC 60C. Finally, tighten the tilt lock on the light stand adaptor to secure it.

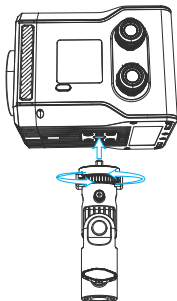

**4. Mounting the Light to a Grip Handle:**

Rotate the handle clockwise onto the RC 60C via the 1/4" threaded hole on the bottom of the RC 60C.

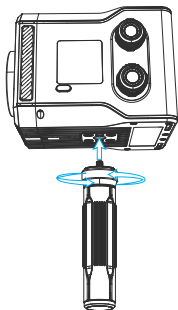
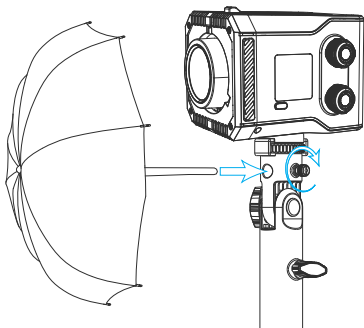
**5. Photographic Lighting Umbrellas Installation:** Insert the handle of the photographic lighting umbrellas into the umbrella hole of the light stand adaptor and tighten the knob on the side to secure it.**6. Creative Installation Methods:** The RC 60C can be flexibly connected to accessories such as a magic arm or clamp via the 1/4" threaded hole to achieve lighting setups in places where it is inconvenient to use a light stand.

## Operations

1. ON/OFF: Turn on the light and rotate the INT knob one turn within 3S (if it does not reach one turn within 3S, rotate it again) to enter the main screen:



2. CCT / HSI / FX / GEL / RGBCW switch: Short press "MODE/RESET".



3. ECO Mode: Press the "ECO" button for 2S to switch between ECO and normal, In ECO mode, the RC 60C power output will be limited to 60%, allowing for extending dash time up to 75minutes.

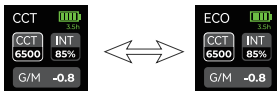

## Detailed operation

### 1. CCT Mode

#### (1) INT adjustment:

Slow-rotate the "INT" knob, The INT is adjusted with  $\pm 1\%$  as the variable; Rapid-rotate the "INT" knob, The INT is adjusted with  $\pm 10\%$  as the variable; Press the "INT" knob, the INT varies from 20% / 40% / 60% / 80% and 100%.

**Notice:** INT is controlled separately at all modes.

#### (2) CCT and G/M:

Press "SEL / ADJ" to switch between CCT and G/M, Slow-rotate the "SEL / ADJ", The CCT is adjusted with  $\pm 100K$  as the variable; Rapid-rotate knob, The CCT is adjusted with  $\pm 1000K$  as the variable; The CCT ranges 2500K to 10000K. At G/M, rotate the "SEL / ADJ", G/M is adjusted with 0.1 as the variable and ranges -1 to 1.

## 2. HSI Mode







### (1) HUE / SAT:

Press the "SEL / ADJ" to switch between HUE and SAT. Rotate the knob to adjust the numbers. HUE ranges 0° - 360° and SAT ranges 0 - 100%.

## 3. FX Mode

### (1) FX/CCT/FRQ:

Press "SEL / ADJ" to switch from FX, CCT and FRQ. Rotate the knob to adjust the FX and CCT, 11 kinds of FX as follows:

Paparazzi	Television	Falty bulb	Lightning	Breathing	Flickering
					

Party	Flame	Fireworks	Police Car	CCT Cycle	Color Cycle
					

### (2) FRQ adjustment:

Rotate the "SEL / ADJ", "FRQ" is adjusted with  $\pm 1$  as the variable and ranges 1 to 10.

## 4. GEL Mode

### (1) LEE / ROSCO

Press the "SEL / ADJ" knob to switch LEE and ROSCO. Rotate the knob to choose the gel LEE (Full CTO, 1/2 CTO, 1/4 CTO, 1/8 CTO, Full CTS, 1/2 CTS, 1/4 CTS, 1/8 CTS) 8 kinds of gels.

ROSCO (Full CTB, 1/2 CTB, 1/4 CTB, 1/8 CTB, Full CTO, 1/2 CTO, 1/4 CTO, 1/8 CTO) 8 kinds of gels.

## 5. RGBCW Mode

Press the "SEL / ADJ" to switch R/G/B/C/W. Rotate to change the numbers. R/G/B ranges 0~255 and C/W aranges 0~100.

## Charging and maintenance

The charging protocols supported are as follows:

PD3.0: 5V / 3A, 9V / 3A, 12V / 3A, 15V / 3A, 20V / 5A,

QC2.0 / AFC / FCP : 5V / 3A, 9V / 2A, 12V / 1.5A

APPLE-2.4A: 5V / 2.4A

### 1. Charging when powering on

Connected the charger and RC 60C with a C-C USB PD charging cable. The screen will display "DC in XXw"(XX indicates the rated power output of the adapter).



### 2. Charging when powering off



### 3. Battery display functions

When the battery is discharging, the remaining usage time is displayed below the battery icon.

Battery level display is as follows:

0-2%	3-25%	26-50%	51-75%	76-100%

Please charge! And the gear will be turned off in 5 seconds.



### 4. Overheating Protection Function

When the battery temperature reaches 62°C / 63°C / 64°C, the output will be reduced to 80% / 65% / 50%. If the battery temperature exceeds 65°C, the light will automatically shut down and display "Overheat" as a warning. When the temperature of the COB reaches 100°C, the output power will be reduced to 70%.



If the screen displays "Sensor error", it indicates that the thermistor on the light has failed. The light will stop running. Please contact the dealer from whom you purchased the light for after-sales service.



The reduction in output power will be indicated on the screen, with the actual percentage of output power displayed at the centre of the image.

## Firmware upgrade

1. Long press "MODE/RESET" to reset the BLE. The BLE icon will blink six times, turn on the BLE of the mobile phone, open the SmallGoGo app to connect with the light.
2. When the firmware needs to be upgraded, connect to the SmallGoGo app wirelessly, The upgrade progress is displayed.



Firmware upgrade successfully

## Specifications

Power Consumption	63W
Cooling Mode	Active Cooling
CCT Range	2500K - 10000K
Charging power / current	48W / 3A
Battery parameters	14.6V / 3400mAh / 49.64Wh
Dash time	45 minutes in full power and 75 minutes in ECO mode
Fan noise	26dB in full power and 23dB in ECO mode
Dimensions	120.0 × 95.0 × 80.0mm / 4.7 × 3.7 × 3.1in
Weight	700.0 ± 10.0g / 24.7 ± 0.4oz

## Brightness test data table

CCT	Distance	INT
3200K	1m	2030Lux
5600K	1m	2350Lux
6900K	1m	2430Lux
R	1m	257Lux
G	1m	1120Lux
B	1m	266Lux

\* The brightness data is average data, and the brightness of different lights will vary.

## 重要提示

感谢您购买 SmallRig 产品。

1. 使用本产品之前，请仔细阅读用户手册。
2. 请注意所有警告提示并遵循使用用户手册内的所有指令。
3. 儿童请在成人指导下使用。
4. 使用前请取下 COB 灯珠的保护罩。
5. 设备使用后，COB 灯珠及面板区域、设备顶部与底部均为高温区域。给设备降温前，请避免接触高温区域。出于您的安全与健康考虑，使用本设备时请勿遮挡散热孔，设备工作时，也不要长时间直视 COB 灯珠。
6. 在存放和收纳之前，请确保设备完全冷却。待设备冷却后，请将其放置在收纳包的相应位置。
7. 为了保证设备正常运作，建议将其存放在阴凉、干燥、整洁的环境中。请勿将本设备存放在潮湿、有液体或其他易燃、易挥发溶剂附近，以避免损坏设备。
8. 如果需要清洁本设备表面，请使用干燥的软布进行清洁。在清洁和维修之前，请务必拔下电源适配器和机身连接线。
9. 为降低电击风险，严禁将本设备浸入水中或其他液体中。
10. 为降低电击风险，严禁私自拆卸本设备。如果设备出现故障需要维修，请咨询相关购买渠道并交由专业维修人员处理。非规范的组装和维修可能存在安全隐患，未经授权禁止私自拆卸。
11. 使用非 SmallRig 推荐的配件可能会引起火灾或电击等危险。请参考 SmallRig 提供的配件，或根据 SmallRig 提供的规格信息，使用经过合格制造商认证的配件。



请勿拆卸产品，如果您怀疑产品任何问题，请联络购买平台，申请售后处理。

## 包装清单 (4808青春版)

RC 60C RGB 影视补光灯	× 1	mini 反光罩	× 1	用户手册	× 1
3米C to C USB PD充电线	× 1	保护罩	× 1		

## 包装清单 (4810续航版)

RC 60C RGB 影视补光灯	× 1	mini 反光罩	× 1	支撑柱	× 1
3米C to C USB PD充电线	× 1	保护罩	× 1	手柄	× 1
20cm C to C USB PD 充电线	× 1	充电宝夹	× 1	收纳包	× 1
用户手册	× 1				

## 产品介绍

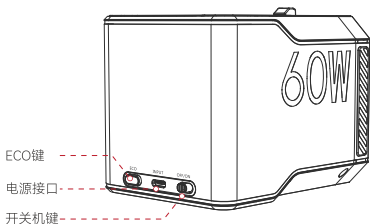
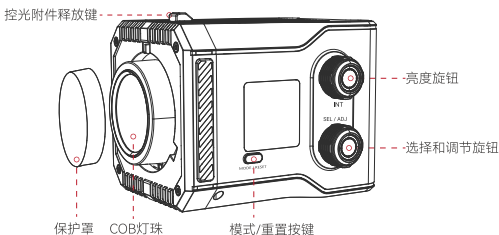

## 安装步骤

1. 取放镜头保护罩：按照箭头方向操作，硅胶保护罩可分别取出 / 放入。

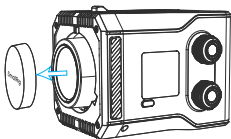

2. S卡口控光附件的安装与拆卸：

Mini卡口控光附件的安装与拆卸：以mini标准罩为例，将mini标准罩对准灯体前盖的mini卡口，逆时针旋转即安装；单击附件释放键，并顺时针旋转mini标准罩进行拆卸。

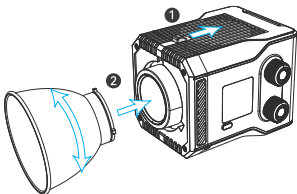

3. 固定灯体至灯架：

先通过RC 60C底部的 1/4" 螺纹孔，将支撑柱与灯体连接，再将支撑柱安装至灯架，并调节RC 60C的照射角度。最后通过支撑柱的旋钮进行锁紧。

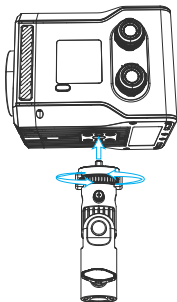

4. 固定灯体至手柄：通过RC 60C底部的1/4" 螺纹孔，将手柄顺时针旋转连接灯体。

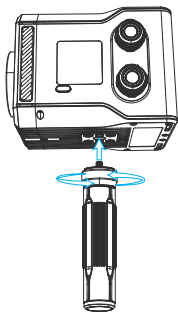

5. 柔光伞的安装：将柔光伞伞柄插入伞孔内，并锁紧伞孔侧边的旋钮即可。

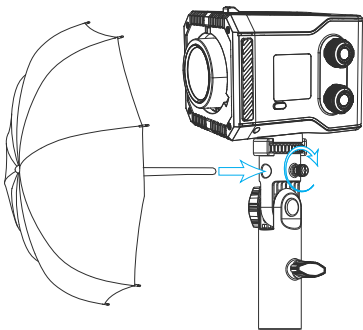

6. 创意安装方式：可以灵活运用魔术手臂 / 蟹钳夹等配件连接RC 60C底部1/4" 螺纹口，在一些不方便放置灯架的地方进行布光。

## 产品操作

1. 开关机：开机显示LOGO 1.5S，进入等待界面，3S内旋转“INT”旋钮一圈（3S内未达到一圈则需重新旋转），进入主界面：



2. 色温 / HSI / 光效 / GEL / RGBCW 切换：单击“MODE / RESET”按键，循环切换CCT / HSI / FX / GEL / RGBCW模式。



3. 性能模式切换：长按“ECO”按键2S，常规模式与ECO模式循环切换，ECO模式以常规模式的60%亮度工作。

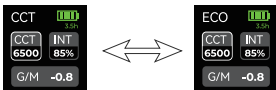

## 操作模式

### 1. 色温模式

#### (1) 亮度调节：

低速旋转“INT”旋钮，亮度以 $\pm 1\%$ 为变量进行调节；

快速旋转“INT”旋钮，亮度以 $\pm 10\%$ 为变量进行调节；亮度范围0 ~ 100%。

单击“INT”旋钮，亮度以20% / 40% / 60% / 80% / 100%循环切换。

注：所有模式亮度都是单独控制和调节，以下不再赘述。

#### (2) CCT / GM：

单击“SEL / ADJ”按钮，切换CCT和G/M，旋转旋钮，对参数进行调节；

切换到CCT，低速旋转“SEL / ADJ”旋钮，色温以 $\pm 100K$ 为变量进行调节；

快速旋转“CCT / FRQ”旋钮，色温以 $\pm 1000K$ 为变量进行调节；

色温范围2500K ~ 10000K。切换到G/M，低速旋转“SEL / ADJ”旋钮，

G/M数值以0.1为单位进行调节，变化范围：-1到1。

## 2. HSI模式

### (1) HUE / SAT:

单击“SEL / ADJ”旋钮，切换HUE和SAT，转动旋钮，对参数进行调节，HUE范围 $0^{\circ} \sim 360^{\circ}$ ，SAT范围 $0 \sim 100\%$ 。

## 3. 光效模式

### (1) FX / CCT / FRQ:

单击“SEL / ADJ”旋钮，切换FX、CCT和FRQ，转动旋钮，对参数进行调节光效种类，11种光效模式循环调节，光效图标如下表：

狗仔队	电视	坏灯泡	闪电	呼吸	闪烁	舞会	火焰	烟花	警车	色温循环	色彩渐变
											

### (2) 频率 (FRQ) 调节:

旋转“SEL / ADJ”旋钮，“FRQ”以 $\pm 1$ 为变量进行调节，频率范围1-10档。

## 4. GEL模式

### (1) LEE / ROSCO

单击“SEL / ADJ”旋钮，切换LEE和ROSCO，转动旋钮，对参数进行调节LEE (Full CTO, 1/2 CTO, 1/4 CTO, 1/8 CTO, Full CTS, 1/2 CTS, 1/4 CTS, 1/8 CTS) 一共8种类型；ROSCO (Full CTB, 1/2 CTB, 1/4 CTB, 1/8 CTB, Full CTO, 1/2 CTO, 1/4 CTO, 1/8 CTO) 一共8种类型。

## 5. RGBCW模式

(1) 单击“SEL / ADJ”旋钮，切换R/G/B/C/W，转动旋钮，对参数进行调节，R/G/B的值范围为 $0 \sim 255$ ，C/W的值范围为 $0 \sim 100$ 。

## 充电与维护

充电支持协议：PD3.0: 5V / 3A、9V / 3A、12V / 3A、15V / 3A、20V / 5A、QC2.0 / AFC / FCP: 5V / 3A、9V / 2A、12V / 1.5A  
APPLE-2.4A: 5V / 2.4A

### 1. 开机充电

① USB-C口接入适配器，设备充电，显示适配器识别功率“DC in xW”，电量图标闪烁；充电时当电池电压<11V时，最大亮度为输入适配器识别功率对应的最大亮度，拔除适配器恢复正常亮度。



② 当电池电压小于11V (电池未接入或死电池)时，最大亮度输出功率为0，大于11V恢复输入适配器识别功率对应的最大亮度)。

③ 开机充电电池电流≤2A (最大功率30W)

2. 关机充电：关机充电电池电流≤3A (最大功率50W)



3. 放电显示：电池放电时，电量图标下方显示剩余使用时间，剩余使用时间随着亮度的变化而变化。

电量档位显示如下表：

0-2%	3-25%	26-50%	51-75%	76-100%



电池电压<11.7V时，低电提示 (Low Battery! Please charge!) 5S后关闭屏幕显示。



### 4. 温度保护

#### (1) 充电：

充电时若电池温度>42°C，降低最大充电功率为30W，电池温度<40°C恢复正常功率充电；

电池温度>45°C，停止充电,电池温度<40°C恢复正常功率充电；

电池温度<=0°C，停止充电，当电池温度>0°C，恢复正常功率充电。

## (2) 放电:

电池温度 $>62^{\circ}\text{C}$ , 降低功率至80%;

电池温度 $>63^{\circ}\text{C}$ , 降低功率至65%;

电池温度 $>64^{\circ}\text{C}$ , 降低功率至50%;

设备温度 $<60^{\circ}\text{C}$ , 可调节到正常亮度100%。

电池温度 $>65^{\circ}\text{C}$ , 停止放电, 设备关机并提示“Overheat!”, 开关重启恢复正常。

若灯珠温度 $>100^{\circ}\text{C}$ , 降低功率至亮度70%,开关重启恢复正常;

若灯珠温度 $>100^{\circ}\text{C}$ , 持续时间60S, 设备关机并提示“Overheat!”, 开关重启恢复正常;

若灯珠温度 $>115^{\circ}\text{C}$ , 设备关机并提示“Overheat!”, 开关重启恢复正常。



## 传感器异常提示:

COB NTC开路设备关机并提示“Sensor error!”, 开关重启恢复正常;



因温度过高降功率, 降到对应功率时对应的亮度值以红色显示。

## 固件升级

1. 长按“MODE / RESET”按键可以重置无线, 蓝牙图标会闪烁6次, 打开手机无线, 打开SmallGoGo app, 选择添加设备, 设备添加连接上以后可以通过app对设备进行控制。

2. 当固件需要升级时, 通过蓝牙连接上SmallGoGo app进行升级, 升级中显示升级进度。

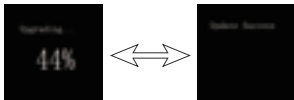

## 产品参数

功率	63W
散热方式	主动散热
色温	2500K - 10000K
充电功率/电流	48W / 3A
电池参数	14.6V / 3400mAh / 49.64Wh
续航时间	满功率输出，续航约45分钟；ECO模式下，续航约75分钟
工作噪声	普通模式下26dB, ECO模式下23dB
机身尺寸	120.0 × 95.0 × 80.0mm
机身重量	700.0 ± 10.0g

## 亮度测试数据表

CCT	距离	照度
3200K	1m	2030Lux
5600K	1m	2350Lux
6900K	1m	2430Lux
R红光	1m	257Lux
G绿光	1m	1120Lux
B蓝光	1m	266Lux

\* 亮度数据为平均数据，不同灯的亮度会有差异。

## Wichtige Hinweise

Vielen Dank für den Kauf von SmallRig Produkten.

1. Bitte lesen Sie das Benutzerhandbuch sorgfältig durch, bevor Sie dieses Produkt verwenden.

2. Bitte beachten Sie alle Warnungen und folgen Sie allen Anweisungen im Benutzerhandbuch.

3. Bei Kindern verwenden Sie das Produkt bitte unter Anleitung eines Erwachsenen.

4. Entfernen Sie vor der Benutzung die Schutzabdeckung des COB-Lampenperlen.

5. Nach der Nutzung des Lichts sind der COB und das Panel, oben und unten, bereiche mit hoher temperatur.

Vermeiden Sie hohe Temperaturen, bevor das Gerät abgekühlt ist. Zu Ihrer Sicherheit und Gesundheit: Blockieren Sie beim Gebrauch des Geräts nicht die Wärmeabfuhröffnungen und schauen Sie nicht längere Zeit direkt auf das Gerät, während es in Betrieb ist.

6. Stellen Sie sicher, dass das Gerät vollständig abgekühlt ist, bevor Sie es verstauen. Nachdem das Gerät abgekühlt ist, legen Sie es an den entsprechenden Platz in der Aufbewahrungstasche.

7. Um den ordnungsgemäßen Betrieb des Geräts zu gewährleisten, wird empfohlen, es in einer kühlen, trockenen und sauberen Umgebung aufzubewahren. Lagern Sie das Gerät nicht in der Nähe von Feuchtigkeit, Flüssigkeiten oder anderen entzündlichen oder flüchtigen Lösungsmitteln. Vermeiden Sie Beschädigungen des Geräts.

8. Wenn Sie die Oberfläche des Geräts reinigen müssen, verwenden Sie ein trockenes, weiches Tuch. Trennen Sie vor dem Reinigen und Warten des Geräts unbedingt den Netzadapter und das Kabel.

9. Um das Risiko eines Stromschlags zu verringern, tauchen Sie das Gerät nicht in Wasser oder andere Flüssigkeiten.

10. Um das Risiko eines Stromschlags zu verringern, zerlegen Sie das Gerät nicht ohne Genehmigung. Wenn das Gerät ausfällt und gewartet werden muss, wenden Sie sich bitte an die entsprechenden Kaufkanäle und lassen Sie es von qualifiziertem Wartungspersonal bearbeiten. Nicht-standardmäßige Montage und Wartung können Sicherheitsrisiken bergen; das unbefugte Zerlegen ist verboten.

11. Die Verwendung von Zubehör, das nicht von SmallRig empfohlen wird, kann Gefahren wie Brand oder Stromschlag verursachen. Bitte verwenden Sie Zubehör, das von SmallRig empfohlen oder nach den von SmallRig bereitgestellten Spezifikationen zertifiziert ist, sowie Zubehör, das von qualifizierten Herstellern zertifiziert ist.



Zerlegen Sie das Produkt nicht. Wenn Sie ein Problem mit dem Produkt vermuten, wenden Sie sich bitte an den Kaufkanal und beantragen Sie den After-Sales-Service.

## Im Karton (4808 Lite Edition)

RC 60C RGB LED Video Light	× 1	User Manual	× 1
mini Reflector	× 1	Protective Cover	× 1
3-meter USB-C to USB-C PD Charging Cable	× 1		

## Im Karton (4810 with Powerbank Clamp Edition)

RC 60C RGB LED Video Light	× 1	User Manual	× 1
mini Reflector	× 1	Protective Cover	× 1
Light Stand Adaptor	× 1	Carrying Bag	× 1
Powerbank Clamp	× 1	Handle	× 1
20cm C to C USB PD Charging Cable	× 1		
3-meter USB-C to USB-C PD Charging Cable	× 1		

## Produktbeschreibung

Auslöser für den  
Modifikator

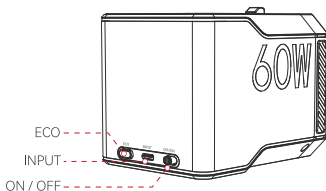
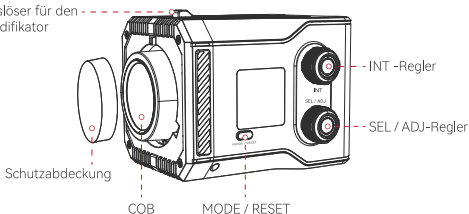

## Installationen

1. **Entfernen oder Einsetzen der Silikonabdeckung:** Folgen Sie den Pfeilen, um die Silikonabdeckung zu entfernen / einzusetzen.

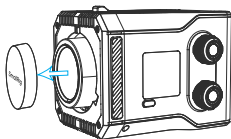

2. **Installation und Entfernung der Mini-Mount Modifikatoren:** Nehmen Sie den Mini-Reflektor als Beispiel. Richten Sie den Mini-Mount-Reflektor mit dem Mini-Mount-Anschluss auf der Frontabdeckung der Leuchte aus, Drehen Sie gegen den Uhrzeigersinn, um ihn zu installieren, Drücken Sie die Mini-Modifiers Freigabetaste und drehen Sie den Mini-Reflektor im Uhrzeigersinn, um ihn zu entfernen,

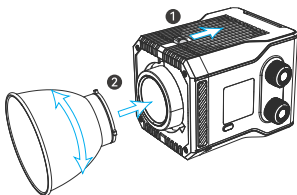

3. **Befestigen der Leuchte an einem Lichtstativ:** Verbinden Sie zunächst den Lichtstativ-Adapter über das 1/4-Zoll-Gewindeloch an der Unterseite des RC 60C. Installieren Sie dann den Lichtstativ-Adapter am Lichtstativ und justieren Sie den Winkel des RC 60C. Zuletzt ziehen Sie die Neigungsverriegelung am Lichtstativ-Adapter fest, um ihn zu sichern.

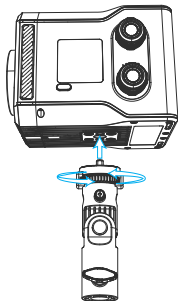

#### 4. Befestigen der Leuchte an einem Griff:

Drehen Sie den Griff im Uhrzeigersinn über das 1/4-Zoll-Gewindeloch an der Unterseite des RC 60C.

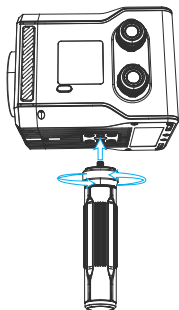

#### 5. Installation von fotografischen Beleuchtungsschirmen:

Führen Sie den Griff der fotografischen Beleuchtungsschirme in das Schirmloch des Lichtstativ-Adapters ein und ziehen Sie die Schraube an der Seite fest, um sie zu sichern.

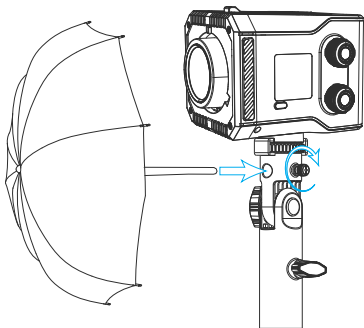

#### 6. Kreative Installationsmethoden:

Der RC 60C kann flexibel mit Zubehör wie einem Magic Arm oder einer Klammer über das 1/4-Zoll-Gewindeloch verbunden werden, um Beleuchtungsaufbauten an Orten zu erreichen, wo die Verwendung eines Lichtstativs unpraktisch ist.

## Betrieb

1. EIN/AUS: Schalten Sie das Licht ein und drehen Sie den INT-Knopf innerhalb von 3 Sekunden eine Umdrehung (wenn er innerhalb von 3 Sekunden nicht eine Umdrehung erreicht, drehen Sie ihn erneut), um zum Hauptbildschirm zu gelangen:



2. CCT/HSI/FX/GEL/RGBCW-Schalter: Kurzes Drücken von "MODE/RESET".



3. ECO-Modus: Drücken Sie die "ECO"-Taste 2 Sekunden lang, um zwischen ECO- und Normalmodus zu wechseln. Im ECO-Modus wird die Leistung des RC 60C auf 60% begrenzt, wodurch die Einsatzzeit auf bis zu 75 Minuten verlängert werden kann.

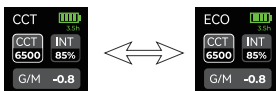

## Detaillierte Bedienung

### 1. CCT-Modus

#### (1) INT-Einstellung:

Langsam den "INT"-Knopf drehen: Die INT wird mit  $\pm 1\%$  angepasst; Schnell den "INT"-Knopf drehen: Die INT wird mit  $\pm 10\%$  angepasst; Drücken Sie den "INT"-Knopf: Die INT wechselt zwischen 20%, 40%, 60%, 80% und 100%.

Hinweis: INT wird in allen Modi separat gesteuert.

#### (2) CCT und G/M:

Drücken Sie "SEL / ADJ", um zwischen CCT und G/M umzuschalten, Langsam den "SEL / ADJ"-Knopf drehen, Die CCT wird mit  $\pm 100\text{K}$  angepasst, Schnell den Knopf drehen, Die CCT wird mit  $\pm 1000\text{K}$  angepasst; Der CCT-Bereich reicht von 2500K bis 10000K. Im G/M-Modus, drehen Sie den „SEL / ADJ“-Knopf, G/M wird mit 0,1 als Variable angepasst und reicht von -1 bis 1.

## 2. HSI-Modus







### (1) HUE/SAT:

Drücken Sie "SEL / ADJ", um zwischen HUE und SAT umzuschalten. Drehen Sie den Knopf, um die Werte anzupassen. HUE reicht von 0° bis 360° und SAT reicht von 0 bis 100%.

## 3. FX-Modus

### (1) FX/CCT/FRQ:

Drücken Sie "SEL / ADJ", um zwischen FX, CCT und FRQ umzuschalten. Drehen Sie den Knopf, um FX und CCT anzupassen. 11 Arten von FX wie folgt:

Paparazzi	Television	Falty bulb	Lightning	Breathing	Flickering
					

Party	Flame	Fireworks	Police Car	CCT Cycle	Color Cycle
					

### (2) FRQ-Anpassung:

Drehen Sie den "SEL / ADJ"-Knopf: "FRQ" wird mit  $\pm 1$  als Variable angepasst und reicht von 1 bis 10.

## 4. GEL-Modus

### (1) LEE / ROSCO

Drücken Sie den "SEL / ADJ"-Knopf, um zwischen LEE und ROSCO umzuschalten. Drehen Sie den Knopf, um das Gel auszuwählen. LEE (Full CTO, 1/2 CTO, 1/4 CTO, 1/8 CTO, Full CTS, 1/2 CTS, 1/4 CTS, 1/8 CTS) – 8 Gel-Typen.

ROSCO (Full CTB, 1/2 CTB, 1/4 CTB, 1/8 CTB, Full CTO, 1/2 CTO, 1/4 CTO, 1/8 CTO) – 8 Gel-Typen.

## 5. RGBCW-Modus

Drücken Sie den "SEL / ADJ"-Knopf, um zwischen R/G/B/C/W umzuschalten. Drehen Sie den Knopf, um die Werte zu ändern. R/G/B reichen von 0-255 und C/W von 0-100.

## Laden und Wartung

Die unterstützten Ladeprotokolle sind wie folgt:

PD3.0: 5V / 3A, 9V / 3A, 12V / 3A, 15V / 3A, 20V / 5A,

QC2.0 / AFC / FCP : 5V / 3A, 9V / 2A, 12V / 1.5A

APPLE-2.4A: 5V / 2.4A

### 1. Laden bei eingeschaltetem Gerät

Schließen Sie das Ladegerät und die RC 60C mit einem C-C USB PD-Ladekabel an. Der Bildschirm zeigt "DC in XXw" an (XX gibt die Nennleistung des Adapters an).



### 2. Laden bei ausgeschaltetem Gerät



### 3. Batterieanzeigefunktionen

Während die Batterie entladen wird, wird die verbleibende Nutzungsdauer unter dem Batteriesymbol angezeigt.

Die Anzeige des Batteriestands erfolgt wie folgt:

0-2%	3-25%	26-50%	51-75%	76-100%

Wenn die Batteriespannung unter 11,7 V fällt, zeigt der Bildschirm "Low Battery! Please charge!" an, und das Gerät wird in 5 Sekunden abgeschaltet.



### 4. Überhitzungsschutzfunktion

Wenn die Batterietemperatur 62°C / 63°C / 64°C erreicht, wird die Ausgangsleistung auf 80% / 65% / 50% reduziert. Wenn die Batterietemperatur 65°C überschreitet, schaltet sich das Licht automatisch aus und zeigt "Overheat" als Warnung an. Wenn die Temperatur der COB 100°C erreicht, wird die Ausgangsleistung auf 70% reduziert. Wenn die hohe Temperatur eine Minute anhält, schaltet sich das Licht aus und zeigt „Overheat“ an. Nachdem die Batterie/das Licht abgekühlt ist, können Sie das Licht neu starten, um den Betrieb fortzusetzen.



Wenn der Bildschirm "Sensorfehler" anzeigt, bedeutet dies, dass der Thermistor am Licht defekt ist. Das Licht wird gestoppt. Bitte wenden Sie sich an den Händler, bei dem Sie das Licht gekauft haben, um den Kundenservice zu kontaktieren.



Die Reduzierung der Ausgangsleistung wird auf dem Bildschirm angezeigt, wobei der tatsächliche Prozentsatz der Ausgangsleistung in der Mitte des Bildes angezeigt wird.

## Firmware-Upgrade

1. Drücken Sie lange auf "MODE/RESET", um das BLE zurückzusetzen. Das BLE-Symbol blinkt sechsmal. Aktivieren Sie das BLE Ihres Mobiltelefons, öffnen Sie die SmallGoGo-App und verbinden Sie sich mit dem Licht.
2. Wenn die Firmware aktualisiert werden muss, verbinden Sie sich drahtlos mit der SmallGoGo-App. Der Fortschritt des Upgrades wird angezeigt.



Firmware-Upgrade  
erfolgreich

## Produktparameter

Energieverbrauch	63W
Kühlmodus	Aktive Kühlung
CCT-Bereich	2500K - 10000K
Ladeleistung / Ladestrom	48W / 3A
Batterieparameter	14,6V / 3400mAh / 49,64Wh
Anzeigezeit	45 Minuten bei voller Leistung und 75 Minuten im ECO-Modus
Lüftergeräusch	26 dB bei voller Leistung und 23 dB im ECO-Modus
Abmessungen	120.0 × 95.0 × 80.0mm / 4.7 × 3.7 × 3.1in
Gewicht	700.0 ± 10.0g / 24.7 ± 0.4oz

## Brightness test data table

CCT	Distance	INT
3200K	1m	2030Lux
5600K	1m	2350Lux
6900K	1m	2430Lux
R	1m	257Lux
G	1m	1120Lux
B	1m	266Lux

\* The brightness data is average data, and the brightness of different lights will vary.

## Remarques importantes

Merci d'avoir acheté un produit SmallRig.

1. Veuillez lire attentivement le manuel d'utilisation avant d'utiliser ce produit.
2. Veuillez prêter attention à tous les avertissements et suivre toutes les instructions du manuel d'utilisation.
3. Pour les enfants, veuillez utiliser le produit sous la supervision d'un adulte.
4. Veuillez retirer le couvercle de protection de la lampe COB avant utilisation.
5. Après utilisation de la lumière, la COB et le panneau, le dessus et le dessous sont des zones à haute température. Avant de refroidir l'appareil, évitez les zones de haute température. Pour votre sécurité et votre santé, ne bloquez pas les orifices de dissipation de chaleur lors de l'utilisation de l'appareil et ne regardez pas directement l'appareil pendant une longue période lorsqu'il est en fonctionnement.
6. Assurez-vous que l'équipement est complètement refroidi avant de le ranger. Après que l'appareil ait refroidi, placez-le dans la position appropriée du sac de stockage.
7. Afin d'assurer un fonctionnement normal de l'équipement, il est recommandé de le stocker dans un environnement frais, sec et propre. Ne rangez pas l'appareil près de l'humidité, des liquides ou d'autres solvants inflammables ou volatils. Évitez d'endommager l'équipement.
8. Si vous devez nettoyer la surface de l'appareil, utilisez un chiffon doux et sec. Avant de nettoyer et d'entretenir, assurez-vous de débrancher l'adaptateur secteur et le câble.
9. Pour réduire le risque de choc électrique, ne plongez pas l'appareil dans l'eau ou d'autres liquides.
10. Afin de réduire le risque de choc électrique, ne démontez pas l'appareil sans autorisation. Si l'appareil tombe en panne et nécessite une maintenance, veuillez consulter les canaux d'achat concernés et faire appel à un personnel de maintenance professionnel. Un assemblage et une maintenance non conformes peuvent présenter des risques pour la sécurité, le démontage non autorisé est interdit.
11. L'utilisation d'accessoires non recommandés par SmallRig peut entraîner des risques tels que des incendies ou des chocs électriques. Veuillez vous référer aux accessoires ou aux spécifications fournies par SmallRig, et utiliser des accessoires certifiés par un fabricant qualifié.



Ne démontez pas le produit. Si vous soupçonnez un problème avec le produit, veuillez contacter le canal d'achat et demander un service après-vente.

## Dans la Boîte (4808 Lite Edition)

RC 60C RGB LED Video Light	× 1	User Manual	× 1
mini Reflector	× 1	Protective Cover	× 1
3-meter USB-C to USB-C PD Charging Cable	× 1		

## Dans la Boîte (4810 with Powerbank Clamp Edition)

RC 60C RGB LED Video Light	× 1	User Manual	× 1
mini Reflector	× 1	Protective Cover	× 1
Light Stand Adaptor	× 1	Carrying Bag	× 1
Powerbank Clamp	× 1	Handle	× 1
20cm C to C USB PD Charging Cable	× 1		
3-meter USB-C to USB-C PD Charging Cable	× 1		

## Produktbeschreibung

Déclencheur de  
déverrouillage

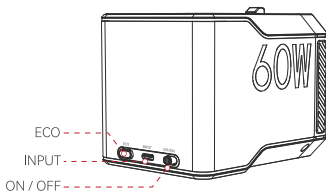
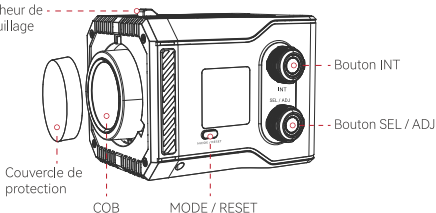

## Étapes d'installation

1. Retrait ou insertion de la couverture en silicone: Suivez les flèches pour retirer/insérer la couverture en silicone.

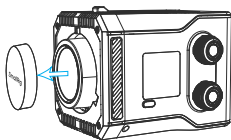

2. Installation et retrait des mini-modificateurs de montage: Prenez un mini réflecteur comme exemple. Alignez le mini-modificateur de montage avec le port de montage mini sur le couvercle avant de la lumière. Tournez dans le sens contraire des aiguilles d'une montre pour installer. Appuyez sur le bouton de libération des mini-modificateurs et tournez le mini réflecteur dans le sens des aiguilles d'une montre pour retirer.

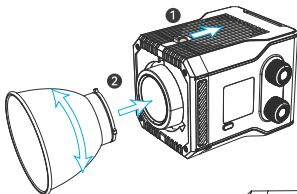

3. Montage de la lumière sur un pied de lumière:

Tout d'abord, fixez l'adaptateur de pied de lumière au RC 60C en utilisant le trou fileté 1/4" en dessous. Ensuite, installez l'adaptateur de pied de lumière sur le pied de lumière et ajustez l'angle du RC 60C. Enfin, serrez le verrou de tilt sur l'adaptateur de pied de lumière pour le sécuriser.

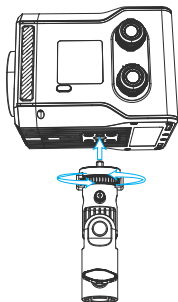

4. **Montage de la lumière sur une poignée de maintien:** Tournez la poignée dans le sens des aiguilles d'une montre sur le RC 60C via le trou fileté 1/4" situé sous le RC 60C.

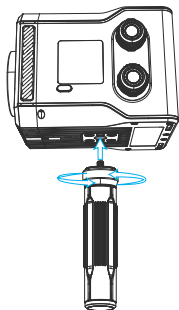

5. **Installation des parapluies d'éclairage photographique:** Insérez la poignée des parapluies d'éclairage photographique dans le trou de parapluie de l'adaptateur de pied de lumière et serrez le bouton sur le côté pour le sécuriser.

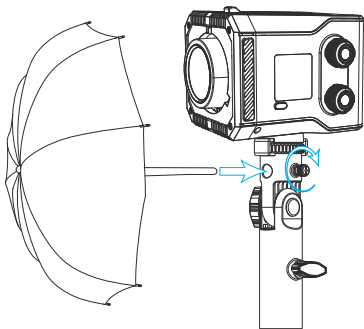

6. **Méthodes d'installation créatives:** Le RC 60C peut être connecté de manière flexible à des accessoires tels qu'un bras magique ou une pince via le trou fileté 1/4" pour réaliser des configurations d'éclairage dans des endroits où l'utilisation d'un pied de lumière est inconfortable.

## Opérations

1. ON/OFF : Allumez la lumière et faites pivoter le bouton INT d'un tour en 3 secondes (si le tour complet n'est pas atteint en 3 secondes, faites-le pivoter à nouveau) pour entrer dans l'écran principal.



2. Interrupteur CCT/HSI/FX/GEL/RGBCW: Appuyez brièvement sur "MODE/RESET".



3. Mode ECO: Appuyez sur le bouton "ECO" pendant 2 secondes pour passer du mode ECO au mode normal. En mode ECO, la puissance de sortie du RC 60C sera limitée à 60%, permettant d'étendre le temps de fonctionnement jusqu'à 75 minutes.

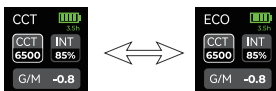

## Opération détaillée

### 1. Mode CCT

#### (1) Réglage INT:

Tournez lentement le bouton "INT" pour ajuster l'INT avec une variation de  $\pm 1\%$ ; Tournez rapidement le bouton "INT" pour ajuster l'INT avec une variation de  $\pm 10\%$ ; Appuyez sur le bouton "INT" pour faire varier l'INT de 20%, 40%, 60%, 80% à 100%.  
Remarque: L'INT est contrôlé séparément dans tous les modes.

#### (2) CCT et G/M:

Appuyez sur "SEL / ADJ" pour passer de CCT à G/M, Tournez lentement le bouton "SEL / ADJ" pour ajuster le CCT avec une variation de  $\pm 100\text{K}$ ; Tournez rapidement le bouton pour ajuster le CCT avec une variation de  $\pm 1000\text{K}$ ; La plage de CCT est de 2500K à 10000K. En mode G/M, tournez le bouton "SEL / ADJ" pour ajuster G/M avec une variation de 0,1, dans une plage de -1 à 1.

## 2. Mode HSI







### (1) HUE/SAT:

Appuyez sur "SEL / ADJ" pour passer de HUE à SAT. Tournez le bouton pour ajuster les valeurs. HUE varie de 0° à 360° et SAT varie de 0 à 100%.

## 3. Mode FX

### (1) FX/CCT/FRQ:

Appuyez sur "SEL / ADJ" pour passer de FX à CCT et FRQ. Tournez le bouton pour ajuster les paramètres FX et CCT. 11 types de FX sont les suivants:

Paparazzi	Television	Falty bulb	Lightning	Breathing	Flickering
					

Party	Flame	Fireworks	Police Car	CCT Cycle	Color Cycle
					

### (2) Réglage FRQ:

Tournez le bouton "SEL / ADJ" pour ajuster le "FRQ" avec une variation de  $\pm 1$ , dans une plage de 1 à 10.

## 4. Mode GEL

### (1) LEE / ROSCO

Appuyez sur le bouton "SEL / ADJ" pour passer de LEE à ROSCO. Tournez le bouton pour choisir le gel: LEE (Full CTO, 1/2 CTO, 1/4 CTO, 1/8 CTO, Full CTS, 1/2 CTS, 1/4 CTS, 1/8 CTS) – 8 types de gels.

ROSCO (Full CTB, 1/2 CTB, 1/4 CTB, 1/8 CTB, Full CTO, 1/2 CTO, 1/4 CTO, 1/8 CTO) – 8 types de gels.

## 5. Mode RGBCW

Appuyez sur le bouton "SEL / ADJ" pour passer entre R/G/B/C/W. Tournez le bouton pour modifier les valeurs. R/G/B vont de 0 à 255 et C/W vont de 0 à 100.

## Chargement et entretien

Les protocoles de chargement pris en charge sont les suivants:

PD3.0: 5V / 3A, 9V / 3A, 12V / 3A, 15V / 3A, 20V / 5A,

QC2.0 / AFC / FCP : 5V / 3A, 9V / 2A, 12V / 1.5A

APPLE-2.4A: 5V / 2.4A

### 1. Chargement pendant l'allumage

Connectez le chargeur et le RC 60C avec un câble USB PD C-C. L'écran affichera "DC in XXw" (XX indique la puissance nominale de l'adaptateur).



### 2. Chargement pendant l'arrêt



### 3. Fonctions d'affichage de la batterie

Lorsque la batterie est en décharge, le temps restant d'utilisation est affiché sous l'icône de la batterie.

L'affichage du niveau de la batterie est le suivant:

0-2%	3-25%	26-50%	51-75%	76-100%

Lorsque la tension de la batterie est inférieure à 11,7 V, l'écran affichera Batterie faible! Veuillez recharger ! et l'engrenage s'éteindra dans 5 secondes.



### 4. Fonction de protection contre la surchauffe

Lorsque la température de la batterie atteint 62 C/63 C/64 C, la puissance de sortie sera réduite à 80%/65%/50%. Si la température de la batterie dépasse 65 C, la lumière s'éteindra automatiquement et affichera "Surchauffe" comme avertissement. Lorsque la température du COB atteint 100 C, la puissance de sortie sera réduite à 70%. Si la haute température persiste pendant une minute, la lumière s'éteindra et affichera "Surchauffe". Après que la température de la batterie/ de la lumière ait refroidi, vous pourrez redémarrer la lumière pour reprendre son fonctionnement.



Si l'écran affiche "Erreur de capteur", cela indique que le thermistor de la lumière a échoué. La lumière cessera de fonctionner. Veuillez contacter le revendeur auprès duquel vous avez acheté la lumière pour le service après-vente.



La réduction de la puissance de sortie sera indiquée sur l'écran, avec le pourcentage réel de la puissance de sortie affiché au centre de l'image.

## Mise à jour du firmware

1. Appuyez longuement sur "MODE/RESET" pour réinitialiser le BLE. L'icône BLE clignotera six fois. Activez le BLE sur votre téléphone mobile, ouvrez l'application SmallGoGo pour vous connecter à la lumière.
2. Lorsque le firmware doit être mis à jour, connectez-vous à l'application SmallGoGo sans fil. La progression de la mise à jour sera affichée.

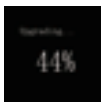

Mise à jour du firmware réussie

## Spécifications

Consumo energetico	63W
Mode de refroidissement	Refroidissement actif
Plage de CCT	2500K - 10000K
Puissance / Courant de charge	48W / 3A
Paramètres de capacité de batterie	14.6V / 3400mAh / 49.64Wh
Temps de tableau	45 minutes à pleine puissance et 75 minutes en mode ECO
Bruit du ventilateur	26 dB à pleine puissance et 23 dB en mode ECO
Dimensions	120,0 × 95,0 × 80,0mm / 4,7 × 3,7 × 3,1in
Poids	700.0 ± 10.0g / 24.7 ± 0.4oz

## Brightness test data table

CCT	Distance	INT
3200K	1m	2030Lux
5600K	1m	2350Lux
6900K	1m	2430Lux
R	1m	257Lux
G	1m	1120Lux
B	1m	266Lux

\* The brightness data is average data, and the brightness of different lights will vary.

## Promemoria Importante

Grazie per aver acquistato il prodotto di SmallRig.

1. Per favore, leggere attentamente il manuale dell'utente prima di utilizzare questo prodotto.
2. Prestare attenzione a tutti gli avvisi e seguire tutte le istruzioni nel manuale dell'utente.
3. Per i bambini, utilizzare sotto la supervisione di un adulto.
4. Rimuovere la copertura protettiva del LED COB prima dell'uso.
5. Dopo l'uso della luce, il COB e il pannello, la parte superiore e inferiore sono aree ad alta temperatura. Evitare le aree ad alta temperatura prima di raffreddare il dispositivo. Per la tua sicurezza e salute, non ostruire il foro di dissipazione del calore durante l'uso del dispositivo e non guardare direttamente il dispositivo per un lungo periodo mentre è in funzione.
6. Assicurarsi che il dispositivo sia completamente raffreddato prima di riporlo. Dopo che il dispositivo si è raffreddato, riporlo nella posizione appropriata della borsa di stoccaggio.
7. Per garantire il normale funzionamento del dispositivo, si consiglia di conservarlo in un ambiente fresco, asciutto e pulito. Non conservare il dispositivo vicino a umidità, liquidi o altri solventi infiammabili o volatili. Evitare di danneggiare il dispositivo.
8. Se è necessario pulire la superficie del dispositivo, utilizzare un panno morbido e asciutto. Prima di pulire e fare manutenzione, assicurarsi di scollegare l'adattatore di alimentazione e il cavo.
9. Per ridurre il rischio di scosse elettriche, non immergere il dispositivo in acqua o altri liquidi.
10. Per ridurre il rischio di scosse elettriche, non smontare il dispositivo senza autorizzazione. Se il dispositivo presenta guasti e necessita di manutenzione, consultare i canali di acquisto pertinenti e farlo trattare da personale di manutenzione qualificato. L'assemblaggio e la manutenzione non standard possono comportare rischi per la sicurezza, e lo smontaggio non autorizzato è vietato.
11. L'uso di accessori non consigliati da SmallRig può causare rischi come incendi o scosse elettriche. Fare riferimento agli accessori o alle specifiche fornite da SmallRig e utilizzare solo accessori certificati da produttori qualificati.



Non smontare il prodotto. Se sospetti problemi con il prodotto, contatta il canale di acquisto e richiedi il servizio post-vendita.

## Nella Scatola (4808 Lite Edition)

RC 60C RGB LED Video Light	× 1	User Manual	× 1
mini Reflector	× 1	Protective Cover	× 1
3-meter USB-C to USB-C PD Charging Cable	× 1		

## Nella Scatola (4810 with Powerbank Clamp Edition)

RC 60C RGB LED Video Light	× 1	User Manual	× 1
mini Reflector	× 1	Protective Cover	× 1
Light Stand Adaptor	× 1	Carrying Bag	× 1
Powerbank Clamp	× 1	Handle	× 1
20cm C to C USB PD Charging Cable	× 1		
3-meter USB-C to USB-C PD Charging Cable	× 1		

## Introduzione al Prodotto

Gancio di Rilascio  
del Modificatore

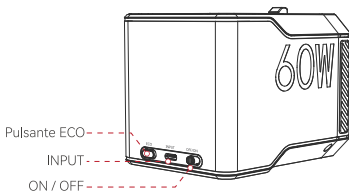
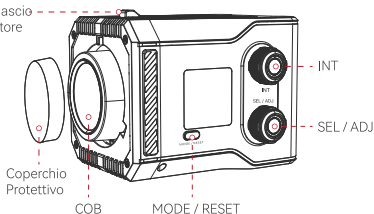

## Installazioni

1. Rimuovere o inserire i copri silicone: Seguire le frecce per rimuovere / inserire il copri silicone.

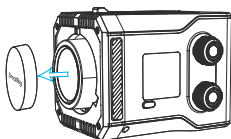

2. Installazione e Rimozione per Modificatori Mini-Mount: Prendere come esempio il riflettore mini. Allineare il riflettore mini-mount con la porta mini-mount sulla copertura frontale della luce. Ruotare in senso antiorario per installare, Premere il pulsante di rilascio dei mini modificatori e ruotare il riflettore mini in senso orario per rimuoverlo.

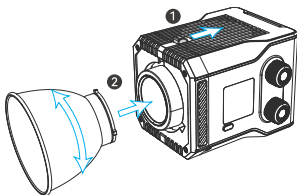

3. Montaggio della Luce su un Treppiede per Luci: Prima, collegare l'adattatore per treppiede alla RC 60C utilizzando il foro filettato da 1/4" sulla parte inferiore. Quindi, installare l'adattatore per treppiede sul treppiede per luci e regolare l'angolo della RC 60C. Infine, serrare il blocco di inclinazione sull'adattatore per treppiede per fissarlo.

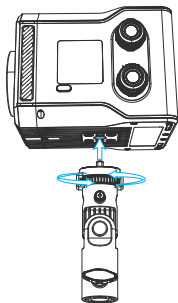

4. **Montaggio della Luce su una Maniglia Grip:** Ruotare la maniglia in senso orario sulla RC 60C tramite il foro filettato da 1/4" sulla parte inferiore della RC 60C.

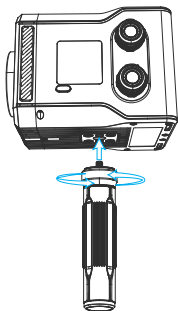

5. **Installazione di Ombrelli Fotografici:** Inserire la maniglia degli ombrelli fotografici nel foro dell'ombrello dell'adattatore per treppiede e serrare la manopola sul lato per fissarla.

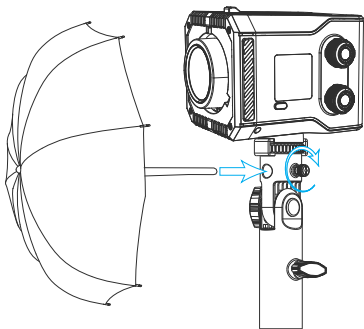

6. **Metodi di Installazione Creativi:** La RC 60C può essere collegata in modo flessibile ad accessori come un braccio magico o una morsetta tramite il foro filettato da 1/4" per realizzare configurazioni di illuminazione in luoghi dove è scomodo utilizzare un treppiede.

## Operazioni

1. **ACCENSIONE/SPEGNIMENTO:** Accendi la luce e ruota la manopola INT di un giro entro 3 secondi (se non raggiungi un giro entro 3 secondi, ruotala di nuovo) per accedere alla schermata principale.



2. **Interruttore CCT/HSI/FX/GEL/RGBCW:** Premi brevemente "MODE/RESET".



3. **Modalità ECO:** Tieni premuto il pulsante "ECO" per 2 secondi per passare tra ECO e normale. In modalità ECO, la potenza di uscita del RC 60C sarà limitata al 60%, permettendo di estendere il tempo di funzionamento fino a 75 minuti.

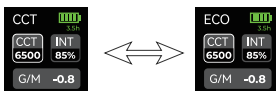

## Operazioni Dettagliate

### 1. Modalità CCT

#### (1) Regolazione INT:

Ruota lentamente la manopola "INT": l'INT viene regolato con  $\pm 1\%$  come variabile; ruota rapidamente la manopola "INT": l'INT viene regolato con  $\pm 10\%$  come variabile; premi la manopola "INT": l'INT varia tra 20%, 40%, 60%, 80% e 100%.

**Nota:** L'INT è controllato separatamente in tutte le modalità.

#### (2) CCT e G/M:

Premi "SEL / ADJ" per passare tra CCT e G/M. Ruota lentamente il "SEL / ADJ": il CCT viene regolato con  $\pm 100K$  come variabile; ruota rapidamente la manopola: il CCT viene regolato con  $\pm 1000K$  come variabile; il range del CCT va da 2500K a 10000K. In G/M, ruota il "SEL / ADJ": G/M viene regolato con 0.1 come variabile e va da -1 a 1.

## 2. Modalità HSI







### (1) HUE/SAT:

Premi "SEL / ADJ" per passare tra HUE e SAT. Ruota la manopola per regolare i valori. HUE va da 0° a 360° e SAT va da 0 a 100%.

## 3. Modalità FX

### (1) FX/CCT/FRQ:

Premi "SEL / ADJ" per passare tra FX, CCT e FRQ. Ruota la manopola per regolare FX e CCT. 11 tipi di FX sono i seguenti:

Paparazzi	Television	Falty bulb	Lightning	Breathing	Flickering
					

Party	Flame	Fireworks	Police Car	CCT Cycle	Color Cycle
					

### (2) Regolazione FRQ:

Ruota il "SEL / ADJ": il "FRQ" viene regolato con  $\pm 1$  come variabile e va da 1 a 10.

## 4. Modalità GEL

### (1) LEE / ROSCO

Premi la manopola "SEL / ADJ" per passare tra LEE e ROSCO. Ruota la manopola per scegliere il gel. LEE (Full CTO, 1/2 CTO, 1/4 CTO, 1/8 CTO, Full CTS, 1/2 CTS, 1/4 CTS, 1/8 CTS) - 8 tipi di gel.

ROSCO (Full CTB, 1/2 CTB, 1/4 CTB, 1/8 CTB, Full CTO, 1/2 CTO, 1/4 CTO, 1/8 CTO) - 8 tipi di gel.

## 5. Modalità RGBCW

Premi "SEL / ADJ" per passare tra R/G/B/C/W. Ruota la manopola per cambiare i valori. R/G/B vanno da 0 a 255 e C/W vanno da 0 a 100.

## Ricarica e Manutenzione

I protocolli di ricarica supportati sono i seguenti:

PD3.0: 5V / 3A, 9V / 3A, 12V / 3A, 15V / 3A, 20V / 5A,

QC2.0 / AFC / FCP : 5V / 3A, 9V / 2A, 12V / 1.5A

APPLE-2.4A: 5V / 2.4A

### 1. Ricarica durante l'accensione:

Collega il caricabatterie e il RC 60C con un cavo USB PD C-C. Lo schermo mostrerà "DC in XXw" (XX indica la potenza nominale dell'adattatore).



### 2. Ricarica durante lo spegnimento



### 3. Funzioni di visualizzazione della batteria

Quando la batteria è in scarica, il tempo rimanente di utilizzo viene visualizzato sotto l'icona della batteria.

La visualizzazione del livello della batteria è la seguente:

0-2%	3-25%	26-50%	51-75%	76-100%

Quando la tensione della batteria scende sotto 11,7V, lo schermo mostrerà "Batteria scarica! Si prega di ricaricare!" e l'apparecchio si spegnerà dopo 5 secondi.



### 4. Funzione di Protezione da Surriscaldamento

Quando la temperatura della batteria raggiunge 62°C/63°C/64°C, l'uscita sarà ridotta all'80%/65%/50%. Se la temperatura della batteria supera 65°C, la luce si spegnerà automaticamente e mostrerà "Surriscaldamento" come avviso. Quando la temperatura del COB raggiunge 100°C, la potenza in uscita sarà ridotta al 70%.

Se l'alta temperatura persiste per un minuto, la luce si spegnerà e mostrerà "Surriscaldamento". Dopo che la temperatura della batteria / lampada si è raffreddata, è possibile riaccendere la luce per riprendere il funzionamento.



Se lo schermo visualizza "Errore del sensore", indica che il termistore sulla luce ha subito un guasto. La luce smetterà di funzionare. Si prega di contattare il rivenditore presso il quale è stato acquistato il prodotto per il servizio post-vendita.



La riduzione della potenza in uscita sarà indicata sullo schermo, con la percentuale effettiva della potenza in uscita visualizzata al centro dell'immagine.

## Aggiornamento del firmware

1. Premere a lungo "MODE/RESET" per resettare il BLE. L'icona BLE lampeggerà sei volte, accendere il BLE del telefono, aprire l'app SmallGoGo per connettersi alla luce.
2. Quando il firmware deve essere aggiornato, collegarsi all'app SmallGoGo senza fili. Il progresso dell'aggiornamento sarà visualizzato.



Aggiornamento del firmware riuscito

## Parametri del prodotto

Consumo energetico	63W
Modalità di Raffreddamento	Raffreddamento Attivo
Intervallo CCT	2500K - 10000K
Potenza / Corrente di carica	48W / 3A
Parametri della batteria	14.6V / 3400mAh / 49.64Wh
Tempo di funzionamento	45 minuti a piena potenza e 75 minuti in modalità ECO
Rumore della ventola	26 dB a piena potenza e 23 dB in modalità ECO
Dimensioni	120,0 × 95,0 × 80,0mm / 4,7 × 3,7 × 3,1in
Peso	700.0 ± 10.0g / 24.7 ± 0.4oz

## Brightness test data table

CCT	Distance	INT
3200K	1m	2030Lux
5600K	1m	2350Lux
6900K	1m	2430Lux
R	1m	257Lux
G	1m	1120Lux
B	1m	266Lux

\* The brightness data is average data, and the brightness of different lights will vary.

## Importante aviso

Gracias por comprar los productos de SmallRig.

1. Lea el manual del usuario detenidamente antes de usar este producto.
2. Preste atención a todas las advertencias y siga todas las instrucciones del manual del usuario.
3. Para los niños, utilícelo bajo la supervisión de un adulto.
4. Retire la cubierta protectora del LED COB antes de usarlo.
5. Después de usar la luz, el COB y el panel, las áreas superior e inferior están a alta temperatura. Antes de enfriar el dispositivo, evite las áreas de alta temperatura. Para su seguridad y salud, no obstruya el orificio de disipación de calor mientras usa el dispositivo, y no mire directamente al dispositivo durante largos períodos de tiempo mientras está en funcionamiento.
6. Asegúrese de que el equipo esté completamente enfriado antes de guardarlo. Después de que el dispositivo se haya enfriado, colóquelo en la posición adecuada de la bolsa de almacenamiento.
7. Para garantizar el funcionamiento normal del equipo, se recomienda almacenarlo en un entorno fresco, seco y limpio. No almacene el dispositivo cerca de ambientes húmedos, líquidos u otros solventes inflamables o volátiles. Evite dañar el equipo.
8. Si necesita limpiar la superficie del dispositivo, use un paño suave y seco. Antes de limpiar y realizar el mantenimiento, asegúrese de desconectar el adaptador de corriente y el cable.
9. Para reducir el riesgo de descarga eléctrica, no sumerja el dispositivo en agua u otros líquidos.
10. Para reducir el riesgo de descarga eléctrica, no desmonte el dispositivo sin permiso. Si el dispositivo falla y necesita mantenimiento, consulte los canales de compra correspondientes y deje que personal de mantenimiento profesional lo maneje. El ensamblaje y mantenimiento no estándar pueden tener riesgos de seguridad; se prohíbe el desensamblaje no autorizado.
11. El uso de accesorios no recomendados por SmallRig puede causar peligros como incendios o descargas eléctricas. Consulte los accesorios o siga las especificaciones proporcionadas por SmallRig, y utilice accesorios certificados por fabricantes calificados.



No desmonte el producto. Si sospecha de algún problema con el producto, comuníquese con el canal de compra y solicite el servicio postventa.

## En la Caja (4808 Lite Edition)

RC 60C RGB LED Video Light	× 1	User Manual	× 1
mini Reflector	× 1	Protective Cover	× 1
3-meter USB-C to USB-C PD Charging Cable	× 1		

## En la Caja (4810 with Powerbank Clamp Edition)

RC 60C RGB LED Video Light	× 1	User Manual	× 1
mini Reflector	× 1	Protective Cover	× 1
Light Stand Adaptor	× 1	Carrying Bag	× 1
Powerbank Clamp	× 1	Handle	× 1
20cm C to C USB PD Charging Cable	× 1		
3-meter USB-C to USB-C PD Charging Cable	× 1		

## Introducción del Producto

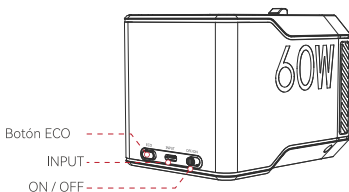
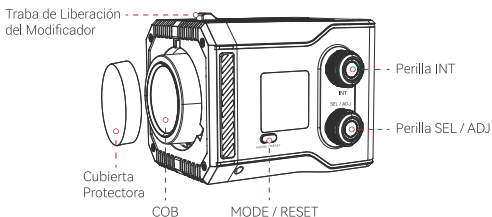

## Instalaciones

1. Quitar o insertar la Cubierta de Silicona: Sigue las flechas para quitar / insertar la cubierta de silicona,

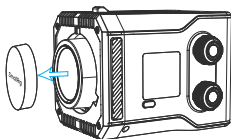

2. Instalación y Retirada de los Mini Modificadores de Montaje: Toma como ejemplo el mini reflector. Alinea el mini reflector con el puerto de montaje mini-mount en la cubierta frontal de la luz. Gira en sentido antihorario para instalar. Presiona el Botón de Liberación de Mini Modificadores y gira el mini reflector en sentido horario para quitarlo.

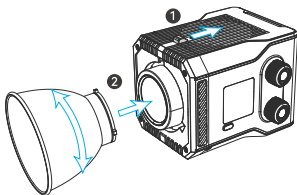

3. Montaje de la Luz en un Soporte de Luz:

Primero, conecta el adaptador de soporte de luz al RC 60C usando el agujero roscado de 1/4" en la parte inferior. Luego, instala el adaptador de soporte de luz en el soporte de luz y ajusta el ángulo del RC 60C.

Finalmente, aprieta el bloqueo de inclinación en el adaptador de soporte de luz para asegurarlo.

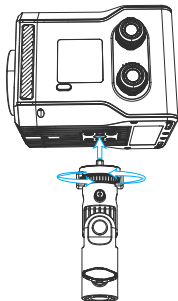

#### 4. Montaje de la Luz en un Mango de Agarre:

Gira el mango en sentido horario en el RC 60C a través del agujero roscado de 1/4" en la parte inferior del RC 60C.

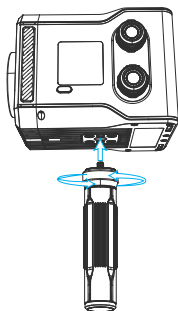

5. **Instalación de Sombrillas de Iluminación Fotográfica:** Inserta el mango de las sombrillas de iluminación fotográfica en el agujero de la sombrilla del adaptador de soporte de luz y aprieta el tornillo en el lateral para asegurarlo.

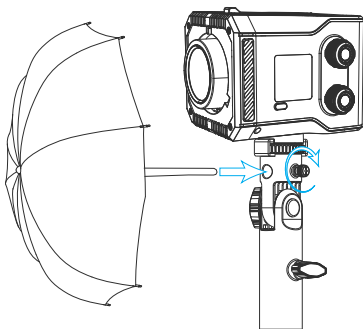

6. **Métodos de Instalación Creativos:** El RC 60C se puede conectar de manera flexible a accesorios como un brazo mágico o abrazadera a través del agujero roscado de 1/4" para lograr configuraciones de iluminación en lugares donde es inconveniente usar un soporte de luz.

## Operaciones

1. ON/OFF: Encienda la luz y gire el botón INT una vuelta en 3 segundos (si no completa una vuelta en 3 segundos, gírelo nuevamente) para ingresar a la pantalla principal.



2. CCT/HSI/FX/GEL/RGBCW switch: Presione brevemente "MODE/RESET".



3. Modo ECO: Mantenga presionado el botón "ECO" durante 2 segundos para alternar entre ECO y normal. En el modo ECO, la salida de potencia del RC 60C se limitará al 60%, permitiendo extender el tiempo de uso hasta 75 minutos.

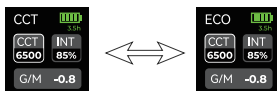

## Operación detallada

### 1. Modo CCT

#### (1) Ajuste INT:

Gire lentamente el botón "INT" para ajustar el INT con una variable de  $\pm 1\%$ ; Gire rápidamente el botón "INT" para ajustar el INT con una variable de  $\pm 10\%$ ; Presione el botón "INT" para ajustar el INT al 20%, 40%, 60%, 80% o 100%.

**Nota:** El INT se controla por separado en todos los modos.

#### (2) CCT y G/M:

Presione "SEL / ADJ" para alternar entre CCT y G/M, Gire lentamente el botón "SEL / ADJ" para ajustar el CCT con una variable de  $\pm 100K$ ; Gire rápidamente el botón para ajustar el CCT con una variable de  $\pm 1000K$ . El rango del CCT es de 2500K a 10000K. En G/M, gire el botón "SEL / ADJ" para ajustar el G/M con una variable de 0.1 y un rango de -1 a 1.

## 2. Modo HS







### (1) HUE/SAT:

Presione "SEL / ADJ" para alternar entre HUE y SAT. Gire el botón para ajustar los valores. El rango de HUE es de 0° a 360° y el de SAT es de 0 a 100%.

## 3. Modo FX

### (1) FX/CCT/FRQ:

Presione "SEL / ADJ" para alternar entre FX, CCT y FRQ. Gire el botón para ajustar FX y CCT. 11 tipos de FX son los siguientes:

Paparazzi	Television	Falty bulb	Lightning	Breathing	Flickering
					

Party	Flame	Fireworks	Police Car	CCT Cycle	Color Cycle
					

### (2) Ajuste de FRQ:

Gire el botón "SEL / ADJ"; el "FRQ" se ajusta con una variable de  $\pm 1$  y un rango de 1 a 10.

## 4. Modo GEL

### (1) LEE / ROSCO

Presione el botón "SEL / ADJ" para alternar entre LEE y ROSCO. Gire el botón para elegir el gel. LEE (Full CTO, 1/2 CTO, 1/4 CTO, 1/8 CTO, Full CTS, 1/2 CTS, 1/4 CTS, 1/8 CTS) – 8 tipos de geles

ROSCO (Full CTB, 1/2 CTB, 1/4 CTB, 1/8 CTB, Full CTO, 1/2 CTO, 1/4 CTO, 1/8 CTO) – 8 tipos de geles

## 5. Modo RGBCW

Presione el botón "SEL / ADJ" para alternar entre R/G/B/C/W. Gire el botón para cambiar los valores. R/G/B tienen un rango de 0 a 255 y C/W tienen un rango de 0 a 100.

## Carga y mantenimiento

Los protocolos de carga compatibles son los siguientes:

PD3.0: 5V / 3A, 9V / 3A, 12V / 3A, 15V / 3A, 20V / 5A,

QC2.0 / AFC / FCP : 5V / 3A, 9V / 2A, 12V / 1.5A

APPLE-2.4A: 5V / 2.4A

### 1. Carga mientras está encendido:

Conecte el cargador y el RC 60C con un cable USB PD C-C. La pantalla mostrará "DC in XXw" (XX indica la potencia nominal de salida del adaptador).



### 2. Carga mientras está apagado



### 3. Funciones de visualización de la batería

Cuando la batería se está descargando, el tiempo restante de uso se muestra debajo del icono de la batería.

La visualización del nivel de la batería es la siguiente:

0-2%	3-25%	26-50%	51-75%	76-100%



Cuando el voltaje de la batería esté por debajo de 11,7V, la pantalla mostrará "¡Batería baja! ¡Por favor, cargue!" y el equipo se apagará en 5 segundos.



### 4. Función de Protección Contra Sobrecalentamiento:

Cuando la temperatura de la batería alcance 62°C/63°C/64°C, la salida se reducirá al 80%/65%/50%. Si la temperatura de la batería supera los 65°C, la luz se apagará automáticamente y mostrará "Sobrecalentamiento" como advertencia. Cuando la temperatura del COB llegue a 100°C, la potencia de salida se reducirá al 70%. Si la alta temperatura persiste durante un minuto, la luz se apagará y mostrará "Sobrecalentamiento". Después de que la temperatura de la batería/luz se haya enfriado, puede reiniciar la luz para reanudar su funcionamiento.



Si la pantalla muestra "Error del sensor", indica que el termistor en la luz ha fallado. La luz dejará de funcionar. Por favor, contacte al distribuidor donde compró la luz para el servicio postventa.



La reducción en la potencia de salida será indicada en la pantalla, con el porcentaje real de la potencia de salida mostrado en el centro de la imagen.

## Actualización de firmware

1. Mantén presionado "MODE/RESET" para reiniciar el BLE. El ícono de BLE parpadeará seis veces, activa el BLE del teléfono móvil, abre la aplicación SmallGoGo para conectar con la luz.
2. Cuando el firmware necesite ser actualizado, conéctate a la aplicación SmallGoGo de forma inalámbrica. El progreso de la actualización se mostrará.

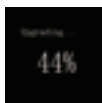

Actualización del firmware exitosa

## Especificaciones

Consumo de energía	63W
Modo de Refrigeración	Refrigeración Activa
Rango CCT	2500K - 10000K
Potencia / corriente de carga	48W / 3A
Parámetros de la batería	14.6V / 3400mAh / 49.64Wh
Tiempo del tablero	45 minutos a potencia máxima y 75 minutos en modo ECO
Ruido del ventilador	26 dB a potencia máxima y 23 dB en modo ECO
Dimensiones	120,0 × 95,0 × 80,0mm / 4,7 × 3,7 × 3,1in
Peso	700.0 ± 10.0g / 24.7 ± 0.4oz

## Brightness test data table

CCT	Distance	INT
3200K	1m	2030Lux
5600K	1m	2350Lux
6900K	1m	2430Lux
R	1m	257Lux
G	1m	1120Lux
B	1m	266Lux

\* The brightness data is average data, and the brightness of different lights will vary.

## Importante Aviso

Obrigado por escolher produto SmallRig.

1. Por favor, leia o manual do usuário cuidadosamente antes de usar este produto.
2. Preste atenção a todos os avisos e siga todas as instruções no manual do usuário.
3. Para crianças, use sob a orientação de um adulto.
4. Remova a capa protetora do LED COB antes de usar.
5. Após o uso da luz, o COB e o painel, a parte superior e inferior são áreas de alta temperatura. Antes de esfriar o dispositivo, evite áreas de alta temperatura. Para sua segurança e saúde, não bloqueie o orifício de dissipação de calor ao usar o dispositivo e não olhe diretamente para o dispositivo por um longo período quando ele estiver em funcionamento.
6. Certifique-se de que o equipamento esteja completamente resfriado antes de armazenar. Após o resfriamento do dispositivo, coloque-o na posição apropriada na bolsa de armazenamento.
7. Para garantir o funcionamento normal do equipamento, recomenda-se armazená-lo em um ambiente fresco, seco e limpo. Não armazene o dispositivo próximo a locais úmidos, líquidos ou outros solventes inflamáveis ou voláteis. Evite danificar o equipamento.
8. Se precisar limpar a superfície do dispositivo, use um pano macio e seco. Antes de limpar e fazer manutenção, certifique-se de desconectar o adaptador de energia e o cabo.
9. Para reduzir o risco de choque elétrico, não mergulhe o dispositivo em água ou outros líquidos.
10. Para reduzir o risco de choque elétrico, não desmonte o dispositivo sem permissão. Se o dispositivo falhar e precisar de manutenção, consulte os canais de compra relevantes e deixe-o ser manuseado por pessoal de manutenção profissional. Montagem e manutenção não padronizadas podem apresentar riscos de segurança; a desmontagem não autorizada é proibida.
11. O uso de acessórios não recomendados pela SmallRig pode causar riscos como incêndio ou choque elétrico. Consulte os acessórios ou as especificações fornecidas pela SmallRig e use acessórios certificados por fabricantes qualificados.



Não desmonte o produto. Se você suspeitar de algum problema com o produto, entre em contato com o canal de compra e solicite o serviço pós-venda.

## Na Caixa (4808 Lite Edition)

RC 60C RGB LED Video Light	× 1	User Manual	× 1
mini Reflector	× 1	Protective Cover	× 1
3-meter USB-C to USB-C PD Charging Cable	× 1		

## Na Caixa (4810 with Powerbank Clamp Edition)

RC 60C RGB LED Video Light	× 1	User Manual	× 1
mini Reflector	× 1	Protective Cover	× 1
Light Stand Adaptor	× 1	Carrying Bag	× 1
Powerbank Clamp	× 1	Handle	× 1
20cm C to C USB PD Charging Cable	× 1		
3-meter USB-C to USB-C PD Charging Cable	× 1		

## Introdução ao Produto

Trava de Liberação  
do Modificador

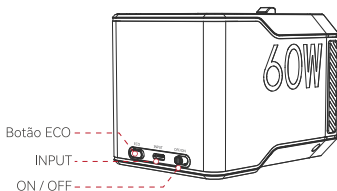
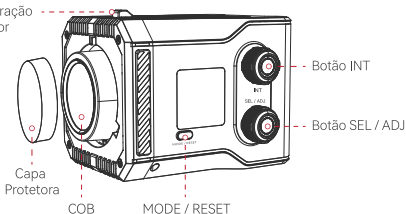

## Instalaciones

1. **Remoção ou inserção da Capa de Silicone:** Siga as setas para remover/insira a capa de silicone.

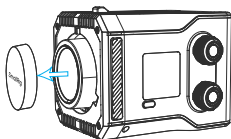

2. **Instalação e Remoção dos Modificadores Mini-Mount:** Tome o mini refletor como exemplo. Alinhe o mini refletor com a porta mini-mount na tampa frontal da luz. Gire no sentido anti-horário para instalar. Pressione o Botão de Liberação dos Mini Modificadores e gire o mini refletor no sentido horário para remover.

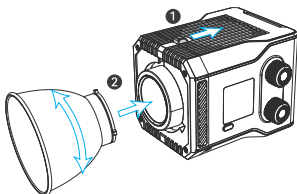

3. **Montagem da Luz em um Suporte de Luz:**

Primeiro, conecte o adaptador de suporte de luz ao RC 60C usando o furo roscado de 1/4" na parte inferior. Em seguida, instale o adaptador de suporte de luz no suporte de luz e ajuste o ângulo do RC 60C. Finalmente, aperte o bloqueio de inclinação no adaptador de suporte de luz para fixá-lo.

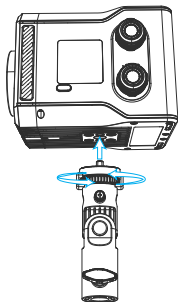

**4. Montagem da Luz em uma Alça de Pega:**

Gire a alça no sentido horário no RC 60C através do furo roscado de 1/4" na parte inferior do RC 60C.

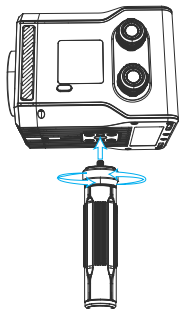
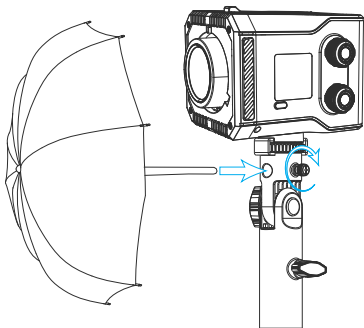
**5. Instalação de Guarda-Chuvas de Iluminação Fotográfica:** Insira o cabo dos guarda-chuvas de iluminação fotográfica no furo do guarda-chuva do adaptador de suporte de luz e aperte o parafuso na lateral para fixá-lo.**6. Métodos de Instalação Criativos:** O RC 60C pode ser conectado de forma flexível a acessórios como um braço mágico ou grampo através do furo roscado de 1/4" para realizar configurações de iluminação em locais onde é inconveniente usar um suporte de luz.

## Operações

1. **LIGAR/DESLIGAR:** Ligue a luz e gire o botão INT uma volta em até 3 segundos (se não completar uma volta em 3 segundos, gire-o novamente) para entrar na tela principal:



2. **Interruptor CCT/HSI/FX/GEL/RGBCW:** Pressione brevemente "MODE/RESET".



3. **Modo ECO:** Pressione o botão "ECO" por 2 segundos para alternar entre ECO e normal. No modo ECO, a saída de potência do RC 60C será limitada a 60%, permitindo estender o tempo de operação para até 75 minutos.

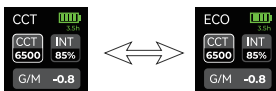

## Operação Detalhada

### 1. Modo CCT

#### (1) Ajuste INT:

Gire lentamente o botão "INT"; o INT é ajustado com  $\pm 1\%$  como variável. Gire rapidamente o botão "INT"; o INT é ajustado com  $\pm 10\%$  como variável. Pressione o botão "INT"; o INT varia entre 20%, 40%, 60%, 80% e 100%.

**Aviso:** O INT é controlado separadamente em todos os modos.

#### (2) CCT e G/M:

Pressione "SEL / ADJ" para alternar entre CCT e G/M. Gire lentamente o botão "SEL / ADJ"; o CCT é ajustado com  $\pm 100K$  como variável. Gire rapidamente o botão; o CCT é ajustado com  $\pm 1000K$  como variável. O intervalo do CCT é de 2500K a 10000K. No G/M, gire o botão "SEL / ADJ"; o G/M é ajustado com 0,1 como variável e varia de -1 a 1.

## 2. Modo HSI







### (1) HUE/SAT:

Pressione "SEL / ADJ" para alternar entre HUE e SAT. Gire o botão para ajustar os valores. HUE varia de 0° a 360° e SAT varia de 0 a 100%.

## 3. Modo FX

### (1) FX/CCT/FRQ:

Pressione "SEL / ADJ" para alternar entre FX, CCT e FRQ. Gire o botão para ajustar o FX e o CCT. 11 tipos de FX são os seguintes:

Paparazzi	Television	Falty bulb	Lightning	Breathing	Flickering
					

Party	Flame	Fireworks	Police Car	CCT Cycle	Color Cycle
					

### (2) Ajuste FRQ:

Gire o botão "SEL / ADJ"; o "FRQ" é ajustado com  $\pm 1$  como variável e varia de 1 a 10.

## 4. Modo GEL

### (1) LEE / ROSCO

Pressione o botão "SEL / ADJ" para alternar entre LEE e ROSCO. Gire o botão para escolher o gel.

LEE (Full CTO, 1/2 CTO, 1/4 CTO, 1/8 CTO, Full CTS, 1/2 CTS, 1/4 CTS, 1/8 CTS) – 8 tipos de gel

ROSCO (Full CTB, 1/2 CTB, 1/4 CTB, 1/8 CTB, Full CTO, 1/2 CTO, 1/4 CTO, 1/8 CTO) – 8 tipos de gel

## 5. Modo RGBCW

Pressione "SEL / ADJ" para alternar entre R/G/B/C/W. Gire o botão para mudar os valores. R/G/B varia de 0 a 255 e C/W varia de 0 a 100.

## Carregamento e manutenção

Os protocolos de carregamento suportados são os seguintes:

PD3.0: 5V / 3A, 9V / 3A, 12V / 3A, 15V / 3A, 20V / 5A,

QC2.0 / AFC / FCP : 5V / 3A, 9V / 2A, 12V / 1.5A

APPLE-2.4A: 5V / 2.4A

### 1. Carregamento com o equipamento ligado

Conecte o carregador e o RC 60C com um cabo USB-C PD. A tela exibirá "DC in XXw" (XX indica a potência nominal de saída do adaptador).



### 2. Carregamento com o equipamento desligado



### 3. Funções de exibição da bateria

Quando a bateria está descarregando, o tempo de uso restante é exibido abaixo do ícone da bateria.

A exibição do nível da bateria é a seguinte:

0-2%	3-25%	26-50%	51-75%	76-100%

Quando a voltagem da bateria estiver abaixo de 11,7V, a tela exibirá "Bateria Fraca! Por favor, carregue!" e o equipamento será desligado em 5 segundos.



### 4. Função de Proteção Contra Sobreaquecimento:

Quando a temperatura da bateria atingir 62°C/63°C/64°C, a saída será reduzida para 80% / 65% / 50%. Se a temperatura da bateria ultrapassar 65°C, a luz será automaticamente desligada e exibirá "Sobreaquecimento" como um aviso. Quando a temperatura do COB atingir 100°C, a potência de saída será reduzida para 70%. Se a alta temperatura persistir por um minuto, a luz será desligada e exibirá "Sobreaquecimento". Após a temperatura da bateria/luz esfriar, você pode reiniciar a luz para retomar a operação.



Se a tela exibir "Erro do sensor", isso indica que o termistor na luz falhou. A luz parará de funcionar. Por favor, entre em contato com o revendedor de onde você comprou a luz para serviço pós-venda.



A redução na potência de saída será indicada na tela, com a porcentagem real de potência de saída exibida no centro da imagem.

## Atualização de firmware

1. Pressione e segure "MODE/RESET" para redefinir o BLE. O ícone do BLE piscará seis vezes; ative o BLE do telefone móvel, abra o aplicativo SmallGoGo para conectar-se à luz.
2. Quando o firmware precisar ser atualizado, conecte-se ao aplicativo SmallGoGo sem fio. O progresso da atualização será exibido.



Atualização de firmware concluída com sucesso

## Especificações

Consumo de Energia	63W
Modo de Refrigeração	Refrigeração Ativa
Faixa CCT	2500K - 10000K
Potência / corrente de carga	48W / 3A
Parâmetros de bateria	14.6V / 3400mAh / 49.64Wh
Tempo do painel	45 minutos em potência máxima e 75 minutos em modo ECO
Ruído do ventilador	26 dB em potência máxima e 23 dB em modo ECO
Dimensões	120,0 × 95,0 × 80,0mm / 4,7 × 3,7 × 3,1in
Peso	700.0 ± 10.0g / 24.7 ± 0.4oz

## Brightness test data table

CCT	Distance	INT
3200K	1m	2030Lux
5600K	1m	2350Lux
6900K	1m	2430Lux
R	1m	257Lux
G	1m	1120Lux
B	1m	266Lux

\* The brightness data is average data, and the brightness of different lights will vary.

## Belangrijke instructies

Bedankt voor uw keuze voor SmallRig-producten.

1. Lees de gebruikershandleiding zorgvuldig door voordat u dit product gebruikt.
2. Let op alle waarschuwingen en volg alle instructies in de gebruikershandleiding.
3. Voor kinderen: gebruik het onder begeleiding van een volwassene.
4. Verwijder de beschermende hoes van de COB-lampkraal voordat u het product gebruikt.
5. Na gebruik van het licht zijn de COB en het paneel, de boven- en onderkant, hoge temperatuurgebieden. Vermijd hoge temperatuurgebieden voordat u het apparaat afkoelt. Voor uw veiligheid en gezondheid, blokkeer de warmteafvoeropening niet tijdens het gebruik van het apparaat en kijk niet langdurig rechtstreeks naar het werkende apparaat.
6. Zorg ervoor dat het apparaat volledig is afgekoeld voordat u het opbergt. Plaats het na afkoeling op de juiste plek in de opbergtas.
7. Om de normale werking van het apparaat te waarborgen, wordt aanbevolen het op te slaan in een koele, droge en schone omgeving. Bewaar het apparaat niet in de buurt van vocht, vloeistoffen of andere brandbare of vluchtige oplosmiddelen. Vermijd schade aan het apparaat.
8. Als u het oppervlak van het apparaat wilt reinigen, gebruik dan een droge, zachte doek. Koppel de voedingsadapter en kabel altijd los voordat u het apparaat schoonmaakt of onderhoudt.
9. Om het risico op elektrische schokken te verminderen, dompel het apparaat niet onder in water of andere vloeistoffen.
10. Om het risico op elektrische schokken te verminderen, mag u het apparaat niet zonder toestemming demonteren. Als het apparaat defect is en onderhoud nodig heeft, raadpleeg dan de relevante aankoopkanalen en laat het onderhouden door gekwalificeerd personeel. Niet-standaard montage en onderhoud kunnen veiligheidsrisico's met zich meebrengen; ongeautoriseerde demontage is verboden.
11. Het gebruik van accessoires die niet door SmallRig worden aanbevolen, kan gevaar zoals brand of elektrische schokken veroorzaken. Raadpleeg de accessoires of de specificaties die door SmallRig zijn verstrekt en gebruik accessoires die zijn gecertificeerd door gekwalificeerde fabrikanten.



Demonteer het product niet. Als u vermoedt dat er een probleem is met het product, neem dan contact op met het aankoopkanaal en vraag om aftersaleservice.

## In de Doos (4808 Lite Edition)

RC 60C RGB LED Video Light	× 1	User Manual	× 1
mini Reflector	× 1	Protective Cover	× 1
3-meter USB-C to USB-C PD Charging Cable	× 1		

## In de Doos(4810 with Powerbank Clamp Edition)

RC 60C RGB LED Video Light	× 1	User Manual	× 1
mini Reflector	× 1	Protective Cover	× 1
Light Stand Adaptor	× 1	Carrying Bag	× 1
Powerbank Clamp	× 1	Handle	× 1
20cm C to C USB PD Charging Cable	× 1		
3-meter USB-C to USB-C PD Charging Cable	× 1		

## Productintroductie

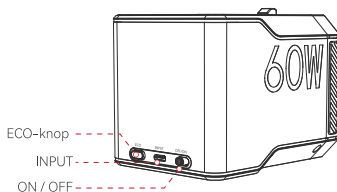
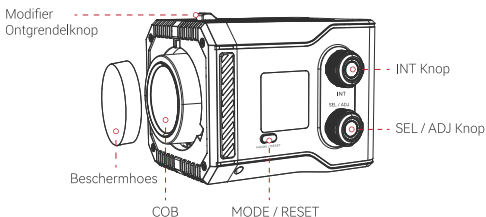

## Installaties

1. **Verwijderen of invoegen van Siliconen Hoes:** Volg de pijlen om de siliconen hoes te verwijderen / in te voegen.

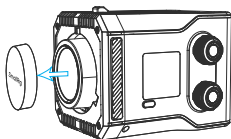

2. **Installatie en Verwijdering van Mini-Mount Modifiers:** Neem de mini-reflector als voorbeeld. Richt de mini-mount reflector uit met de mini-mount poort op de voorkant van het licht. Draai tegen de klok in om te installeren. Druk op de Mini modifiers Ontgrendelknop en draai de mini-reflector met de klok mee om te verwijderen.

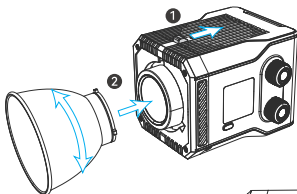

3. **Bevestigen van het Licht aan een Lichtstatief:** Verbind eerst de lichtstatief adapter met de RC 60C via het 1/4" schroefgat aan de onderkant. Installeer vervolgens de lichtstatief adapter op het lichtstatief en pas de hoek van de RC 60C aan. Draai ten slotte de kantelvergrendeling op de lichtstatief adapter aan om deze te beveiligen.

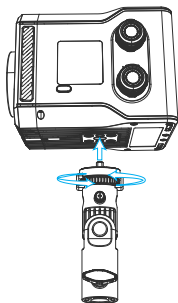

#### 4. Bevestigen van het Licht aan een Handgreep:

Draai de handgreep met de klok mee op de RC 60C via het 1/4" schroefgat aan de onderkant van de RC 60C.

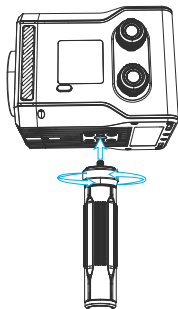

#### 5. Installatie van Fotografische Verlichtingsparaplu's: Steek de handgreep van de fotografische verlichtingsparaplu's in het paraplu gat van de lichtstatief adapter en draai de knop aan de zijkant aan om deze te beveiligen.

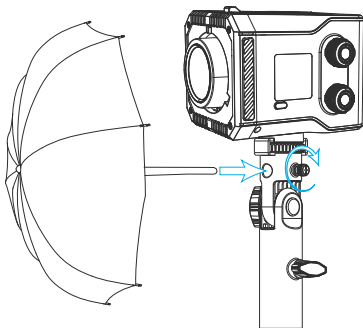

#### 6. Creatieve Installatiemethoden: De RC 60C kan flexibel worden aangesloten op accessoires zoals een magische arm of klem via het 1/4" schroefgat om verlichtingsopstellingen te realiseren op plaatsen waar het onhandig is om een lichtstatief te gebruiken.

## Bedieningen

1. **AAN/UIT:** Zet het licht aan en draai de INT-knop één volledige draai binnen 3 seconden (als het niet binnen 3 seconden één volledige draai heeft bereikt, draai dan opnieuw) om naar het hoofdscherm te gaan:



2. **CCT/HSI/FX/GEL/RGBCW-schakelaar:** Druk kort op "MODE/RESET".



3. **ECO-modus:** Druk 2 seconden op de "ECO"-knop om te schakelen tussen ECO en normaal. In ECO-modus wordt de RC 60C-vermogenuitgang beperkt tot 60%, wat de gebruikstijd tot 75 minuten kan verlengen.

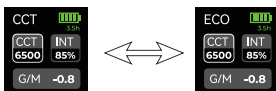

## Gedetailleerde bediening

### 1. CCT-modus

#### (1) INT-aanpassing:

Langzaam draaien aan de "INT"-knop, de INT wordt aangepast met  $\pm 1\%$  als variabele; snel draaien aan de "INT"-knop, de INT wordt aangepast met  $\pm 10\%$  als variabele; Druk op de "INT"-knop, de INT varieert tussen 20%, 40%, 60%, 80% en 100%.  
**Opmerking:** INT wordt afzonderlijk geregeld in alle modi.

#### (2) CCT en G/M:

Druk op "SEL / ADJ" om te schakelen tussen CCT en G/M. Langzaam draaien aan de "SEL / ADJ"-knop, de CCT wordt aangepast met  $\pm 100K$  als variabele; snel draaien aan de knop, de CCT wordt aangepast met  $\pm 1000K$  als variabele; De CCT-reikwijdte is 2500K tot 10000K.

Bij G/M, draai aan de "SEL / ADJ"-knop, G/M wordt aangepast met 0.1 als variabele en reikt van -1 tot 1.

## 2. HSI-modus







### (1) HUE/SAT:

Druk op "SEL / ADJ" om te schakelen tussen HUE en SAT. Draai aan de knop om de waarden aan te passen. HUE reikt van 0° tot 360° en SAT van 0 tot 100%.

## 3. FX-modus

### (1) FX/CCT/FRQ:

Druk op "SEL / ADJ" om te schakelen tussen FX, CCT en FRQ. Draai aan de knop om FX en CCT aan te passen. 11 soorten FX zijn als volgt:

Paparazzi	Television	Falty bulb	Lightning	Breathing	Flickering
					

Party	Flame	Fireworks	Police Car	CCT Cycle	Color Cycle
					

### (2) FRQ-aanpassing:

Draai aan de "SEL / ADJ"-knop, "FRQ" wordt aangepast met  $\pm 1$  als variabele en reikt van 1 tot 10.

## 4. GEL-modus

### (1) LEE / ROSCO

Druk op de "SEL / ADJ"-knop om te schakelen tussen LEE en ROSCO. Draai aan de knop om het gel-nummer te kiezen. LEE (Full CTO, 1/2 CTO, 1/4 CTO, 1/8 CTO, Full CTS, 1/2 CTS, 1/4 CTS, 1/8 CTS) - 8 soorten gels

ROSCO (Full CTB, 1/2 CTB, 1/4 CTB, 1/8 CTB, Full CTO, 1/2 CTO, 1/4 CTO, 1/8 CTO) - 8 soorten gels

## 5. RGBCW-modus

Druk op de "SEL / ADJ" om te schakelen tussen R/G/B/C/W. Draai om de waarden te veranderen. R/G/B reikt van 0 tot 255 en C/W van 0 tot 100.

## Opladen en onderhoud

De ondersteunde oplaadprotocollen zijn als volgt:

PD3.0: 5V / 3A, 9V / 3A, 12V / 3A, 15V / 3A, 20V / 5A,

QC2.0 / AFC / FCP : 5V / 3A, 9V / 2A, 12V / 1.5A

APPLE-2.4A: 5V / 2.4A

### 1. Opladen tijdens het inschakelen

Verbind de oplader en RC 60C met een C-C USB PD-oplaadkabel. Het scherm toont "DC in XXw" (XX geeft het nominale uitgangsvermogen van de adapter aan).



### 2. Opladen tijdens uitschakeling



### 3. Batterijweergavefuncties

Wanneer de batterij wordt ontladen, wordt de resterende gebruikstijd onder het batterij-icoon weergegeven.

De batterij-niveaoweergave is als volgt:

0-2%	3-25%	26-50%	51-75%	76-100%



Wanneer de batterijspanning onder 11,7V zakt, toont het scherm "Low Battery! Please charge!" en wordt de uitrusting binnen 5 seconden uitgeschakeld.



### 4. Oververhittingsbeveiligingsfunctie:

Wanneer de batterijtemperatuur 62°C/63°C/64°C bereikt, wordt de output verminderd tot 80%/65%/50%. Als de batterijtemperatuur boven de 65°C komt, zal het licht automatisch uitschakelen en "Overheat" tonen als waarschuwing. Wanneer de temperatuur van de COB 100°C bereikt, wordt het uitgangsvermogen verminderd tot 70%. Als de hoge temperatuur één minuut aanhoudt, schakelt het licht uit en toont het "Overheat". Nadat de batterij/het licht is afgekoeld, kunt u het licht opnieuw inschakelen om de werking te hervatten.



Als het scherm "Sensor error" toont, betekent dit dat de thermistor op het licht is mislukt. Het licht zal stoppen met werken. Neem contact op met de dealer van wie u het licht heeft gekocht voor after-sales service.



De vermindering van het uitgangsvermogen wordt op het scherm weergegeven, met het werkelijke percentage van het uitgangsvermogen in het midden van het beeld weergegeven.

## Firmware-upgrade

1. Houd de knop "MODE/RESET" ingedrukt om de BLE te resetten. Het BLE-icoon knippert zes keer. Zet de BLE van de mobiele telefoon aan, open de SmallGoGo-app en verbind met het licht.
2. Wanneer de firmware moet worden bijgewerkt, verbind draadloos met de SmallGoGo-app. De voortgang van de upgrade wordt weergegeven.



Firmware-upgrade  
succesvol

## Specificaties

Vermogensverbruik	63W
Koelingsmodus	Actieve Koeling
CCT Bereik	2500K - 10000K
Oplaadvermogen / stroom	48W / 3A
Batterijparameters	14.6V / 3400mAh / 49.64Wh
Dash-tijd	45 minuten op volle kracht en 75 minuten in ECO-modus
Fan-geluid	26 dB op volle kracht en 23 dB in ECO-modus
Afmetingen	120,0 × 95,0 × 80,0mm / 4,7 × 3,7 × 3,1in
Gewicht	700.0 ± 10.0g / 24.7 ± 0.4oz

## Brightness test data table

CCT	Distance	INT
3200K	1m	2030Lux
5600K	1m	2350Lux
6900K	1m	2430Lux
R	1m	257Lux
G	1m	1120Lux
B	1m	266Lux

\* The brightness data is average data, and the brightness of different lights will vary.

## Viktig prompt

Tack för att du väljer SmallRig-produkter.

1. Vänligen läs bruksanvisningen noggrant innan du använder denna produkt.
2. Var vänlig uppmärksamma alla varningar och följ alla instruktioner i bruksanvisningen.
3. För barn, använd produkten under vuxenövervakning.
4. Ta bort det skyddande täcklocket från COB-lampan innan du använder den.
5. Efter användning är COB:n och panelen, både på toppen och botten, områden med hög temperatur. Undvik att vara nära dessa högtemperaturområden innan enheten har svalnat. För din säkerhet och hälsa, blockera inte ventilationshålen när enheten är i bruk, och titta inte direkt på enheten under lång tid när den är påslagen.
6. Se till att utrustningen är helt nedkyld innan du förvarar den. När enheten har svalnat, placera den på rätt plats i förvaringsväskan.
7. För att säkerställa normal drift av utrustningen rekommenderas det att förvara den i en sval, torr och ren miljö. Förvara inte enheten nära fukt, vätskor eller andra brandfarliga eller flyktiga lösningsmedel. Undvik att skada utrustningen.
8. Om du behöver rengöra enhetens yta, använd en torr, mjuk trasa. Koppla alltid bort strömadaptern och kabeln innan du rengör eller servar enheten.
9. För att minska risken för elektriska stötar, doppa inte enheten i vatten eller andra vätskor.
10. För att minska risken för elektriska stötar, montera inte isär enheten utan tillstånd. Om enheten går sönder och behöver service, vänligen kontakta de relevanta inköpskanalerna och låt den hanteras av professionell servicepersonal. Ej-standardmässig montering och underhåll kan innebära säkerhetsrisker, och obehörig demontering är förbjuden.
11. Användning av tillbehör som inte rekommenderas av SmallRig kan orsaka faror som brand eller elektriska stötar. Vänligen använd tillbehör enligt specifikationerna från SmallRig och certifierade tillbehör från kvalificerade tillverkare.



Demontera inte produkten. Om du misstänker något problem med produkten, vänligen kontakta inköpskanalen och begär eftermarknadstjänst.

## I Lådan (4808 Lite Edition)

RC 60C RGB LED Video Light	× 1	User Manual	× 1
mini Reflector	× 1	Protective Cover	× 1
3-meter USB-C to USB-C PD Charging Cable	× 1		

## I Lådan(4810 with Powerbank Clamp Edition)

RC 60C RGB LED Video Light	× 1	User Manual	× 1
mini Reflector	× 1	Protective Cover	× 1
Light Stand Adaptor	× 1	Carrying Bag	× 1
Powerbank Clamp	× 1	Handle	× 1
20cm C to C USB PD Charging Cable	× 1		
3-meter USB-C to USB-C PD Charging Cable	× 1		

## Produktintroduktion

Modifiering  
sfrigöringsknapp

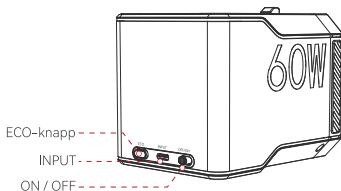
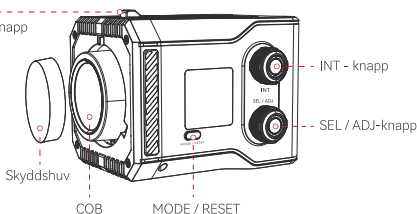

## Installation

1. Ta bort eller sätt i silikonhöljet: Följ pilarna för att ta bort / sätta i silikonhöljet.

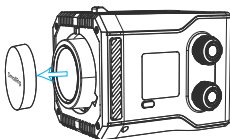

2. Installation och borttagning av Mini-Mount-modifierare: Ta mini-reflektorn som ett exempel. Aligna mini-mount-reflektorn med mini-mount-porten på fronskyddet för ljuset. Vrid moturs för att installera. Tryck på Mini modifiers Release Button och vrid mini-reflektorn medurs för att ta bort den.

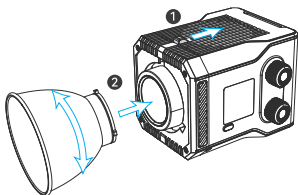

3. Montering av ljuset på en ljusstativ: Först, anslut ljusstadsadaptarna till RC 60C med hjälp av den 1/4-tums gängade hålet på undersidan. Installera sedan ljusstadsadaptarna på ljusstativet och justera vinkeln på RC 60C. Dra åt tillåset på ljusstadsadaptarna för att säkra det.

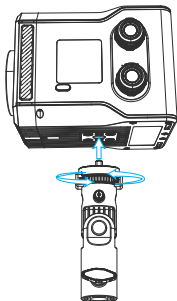

#### 4. Montering av ljuset på ett handtag:

Vrid handtaget medurs på RC 60C via det 1/4-tums gängade hålet på botten av RC 60C.

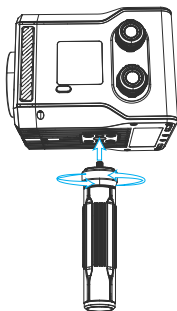

#### 5. Installation av fotografiska ljusparaplyer: Sätt in handtaget på de fotografiska ljusparaplyerna i paraplyhålet på ljusstadsadapterna och dra åt knoppen på sidan för att säkra den.

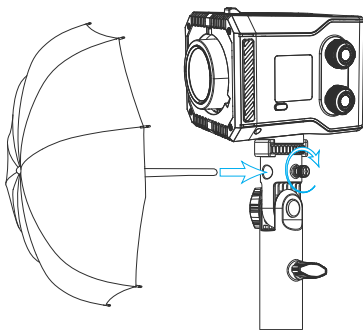

#### 6. Kreativa installationsmetoder: RC 60C kan flexibelt anslutas till tillbehör som en magisk arm eller klämman via det 1/4-tums gängade hålet för att uppnå ljusinställningar på platser där det är opraktiskt att använda ett ljusstativ.

## Operationer

1. ON/OFF: Slå på ljuset och vrid INT-knappen ett helt varv inom 3 sekunder (om det inte vrids ett helt varv inom 3 sekunder, vrid den igen) för att komma till huvudskärmen:



2. CCT/HSI/FX/GEL/RGBCW-brytare: Tryck kort på "MODE/RESET".



3. ECO-läge: Håll ned "ECO"-knappen i 2 sekunder för att växla mellan ECO och normal. I ECO-läge begränsas RC 60C:s effektutgång till 60%, vilket möjliggör en förlängning av drifttiden upp till 75 minuter.

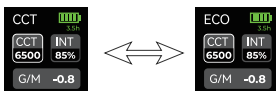

## Detaljerad drift

### 1. CCT-läge

#### (1) INT-justering:

Vrid långsamt på "INT"-knappen, så justeras INT med  $\pm 1\%$  som variabel; vrid snabbt på "INT"-knappen, så justeras INT med  $\pm 10\%$  som variabel; tryck på "INT"-knappen för att växla mellan INT-värdena 20%, 40%, 60%, 80% och 100%.

Observera: INT kontrolleras separat i alla lägen.

#### (2) CCT och G/M:

Tryck på "SEL / ADJ" för att växla mellan CCT och G/M. Vrid långsamt på "SEL / ADJ" för att justera CCT med  $\pm 100K$  som variabel; vrid snabbt på knappen för att justera CCT med  $\pm 1000K$  som variabel; CCT-intervallet är 2500K till 10000K.

I G/M-läget, vrid på "SEL / ADJ" för att justera G/M med 0,1 som variabel och intervallet är -1 till 1.

## 2. HSI-läge







### (1) HUE/SAT:

Tryck på "SEL / ADJ" för att växla mellan HUE och SAT. Vrid på knappen för att justera värdena. HUE-intervallet är 0°~360° och SAT-intervallet är 0~100%.

## 3. FX-läge

### (1) FX/CCT/FRQ:

Tryck på "SEL / ADJ" för att växla mellan FX, CCT och FRQ. Vrid på knappen för att justera FX och CCT, 11 olika FX som följer:

Paparazzi	Television	Falty bulb	Lightning	Breathing	Flickering
					

Party	Flame	Fireworks	Police Car	CCT Cycle	Color Cycle
					

### (2) FRQ-justering:

Vrid på "SEL / ADJ" för att justera "FRQ" med  $\pm 1$  som variabel, och intervallet är 1 till 10.

## 4. GEL-läge

### (1) LEE / ROSCO

Tryck på "SEL / ADJ"-knappen för att växla mellan LEE och ROSCO. Vrid på knappen för att välja gel. LEE (Full CTO, 1/2 CTO, 1/4 CTO, 1/8 CTO, Full CTS, 1/2 CTS, 1/4 CTS, 1/8 CTS) – 8 typer av gels

ROSCO (Full CTB, 1/2 CTB, 1/4 CTB, 1/8 CTB, Full CTO, 1/2 CTO, 1/4 CTO, 1/8 CTO) – 8 typer av gels

## 5. RGBCW-läge

Tryck på "SEL / ADJ" för att växla mellan R/G/B/C/W. Vrid på knappen för att ändra värdena. R/G/B-intervallet är 0~255 och C/W-intervallet är 0~100.

## Laddning och underhåll

De stödda laddningsprotokollen är följande:

PD3.0: 5V / 3A, 9V / 3A, 12V / 3A, 15V / 3A, 20V / 5A,

QC2.0 / AFC / FCP : 5V / 3A, 9V / 2A, 12V / 1.5A

APPLE-2.4A: 5V / 2.4A

### 1. Laddning när den är påslagen:

Anslut laddaren och RC 60C med en C-C USB PD-laddningskabel. Skärmen visar "DC in XXw" (XX indikerar den nominella effektutgången för adaptern).



### 2. Laddning när den är avstängd



### 3. Batterivisningsfunktioner

När batteriet är i användning visas den återstående användningstiden under batteriikonen.

Batterinivåvisningen är följande:

0-2%	3-25%	26-50%	51-75%	76-100%

När batterispänningen är under 11,7V visar skärmen "Low Battery! Please charge!" och utrustningen stängs av efter 5 sekunder.



### 4. Överhettningsskyddsfunktion

När batteriets temperatur når 62°C/63°C/64°C kommer utgångseffekten att reduceras till 80%/65%/50%. Om batteriets temperatur överstiger 65°C stängs lampan av automatiskt och visar "Overheat" som en varning. När temperaturen på COB når 100°C kommer utgångseffekten att reduceras till 70%. Om den höga temperaturen kvarstår i en minut stängs lampan av och visar "Overheat". Efter att batteriet/lampan har svalnat kan du starta om lampan för att återuppta driften.



Om skärmen visar "Sensor error" indikerar det att termistorn på lampan har gått sönder. Lampan kommer att sluta fungera. Vänligen kontakta återförsäljaren där du köpte lampan för eftermarknadstjänst.



Minskningen av utgångseffekten kommer att visas på skärmen, med den faktiska procentandelen av utgångseffekten visad i mitten av bilden.

## Firmwareuppgradering

1. Håll ned "MODE/RESET" för att återställa BLE. BLE-ikonen kommer att blinka sex gånger. Slå på BLE på mobilen, öppna SmallGoGo-appen och anslut till lampan.
2. När firmware behöver uppgraderas, anslut trådlöst till SmallGoGo-appen. Uppgraderingsprocessen visas.



Firmwareuppgraderingen lyckades

## Specifikationer

Strömförbrukning	63W
Kylmetod	Aktiv kylning
CCT-Omfång	2500K - 10000K
Laddningskraft / ström	48W / 3A
Parametrar för batteri	14.6V / 3400mAh / 49.64Wh
Dash-tid	45 minuter på full effekt och 75 minuter i ECO-läge
Fläktljud	26 dB på full effekt och 23 dB i ECO-läge
Dimensioner	120,0 × 95,0 × 80,0mm / 4,7 × 3,7 × 3,1in
Vikt	700.0 ± 10.0g / 24.7 ± 0.4oz

## Brightness test data table

CCT	Distance	INT
3200K	1m	2030Lux
5600K	1m	2350Lux
6900K	1m	2430Lux
R	1m	257Lux
G	1m	1120Lux
B	1m	266Lux

\* The brightness data is average data, and the brightness of different lights will vary.

## 중요한 팁

SmallRig 제품을 구입해 주셔서 감사합니다.

1. 이 제품을 사용하기 전에 사용자 설명서를 주의 깊게 읽어 주십시오.
2. 모든 경고를 주의하고 사용자 설명서의 모든 지침을 따르십시오.
3. 어린이의 경우 성인의 지도 하에 사용하십시오.
4. 사용하기 전에 COB 램프 비드의 보호 덮개를 제거하십시오.
5. 조명을 사용한 후, COB 및 패널, 상단 및 하단은 고온 영역입니다. 장치를 냉각하기 전에 고온 영역을 피하십시오. 안전과 건강을 위해 장치 사용 시 열 방출 구멍을 막지 말고, 장치가 작동할 때는 장치를 오랫동안 직접 보지 마십시오.
6. 장치가 완전히 식은 후에 보관하십시오. 장치가 식은 후에는 보관 가방의 적절한 위치에 놓아 주십시오.
7. 장비의 정상적인 작동을 보장하기 위해 서늘하고 건조하며 깨끗한 환경에 보관하는 것이 좋습니다. 장치를 습기, 액체 또는 기타 인화성 또는 휘발성 용매 근처에 보관하지 마십시오. 장비가 손상되지 않도록 주의하십시오.
8. 장치의 표면을 청소해야 할 경우, 마른 부드러운 천을 사용하십시오. 청소 및 유지 보수 전에 반드시 전원 어댑터와 케이블을 분리하십시오.
9. 전기 충격의 위험을 줄이기 위해 장치를 물이나 기타 액체에 담그지 마십시오.
10. 전기 충격의 위험을 줄이기 위해 무단으로 장치를 분해하지 마십시오. 장치에 문제가 발생하고 수리가 필요할 경우, 관련 구매 채널에 문의하고 전문 유지 보수 인력에 의해 처리되도록 하십시오. 비표준 조립 및 유지 보수는 보안 위험을 초래할 수 있으며, 무단 분해는 금지됩니다.
11. SmallRig에서 권장하지 않는 액세서리를 사용할 경우 화재나 전기 충격과 같은 위험이 발생할 수 있습니다. SmallRig에서 제공한 사양에 맞는 액세서리 또는 인증된 제조업체의 액세서리를 사용하십시오.



제품을 분해하지 마십시오. 제품에 문제가 의심되는 경우 구매 채널에 연락하여 애프터 서비스 신청을 하십시오.

## 박스내용물 (4808 Lite Edition)

RC 60C RGB 필름 및 TV 보조광	× 1	미니 반사경	× 1	사용설명서	× 1
3m C-C USB PD 충전 케이블	× 1	보호 커버	× 1		

## 박스내용물 (4810 with Powerbank Clamp Edition)

RC 60C RGB 필름 및 TV 보조광	× 1	미니 반사경	× 1	지원 칼럼	× 1
3m C-C USB PD 충전 케이블	× 1	보호 커버	× 1	핸들	× 1
20cm C-C USB PD 충전 케이블	× 1	보조배터리 클립	× 1	보관 가방	× 1

사용설명서

## 제품 소개

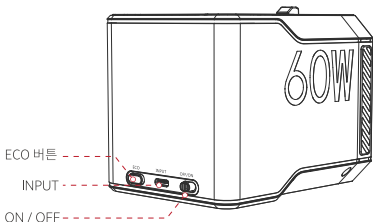
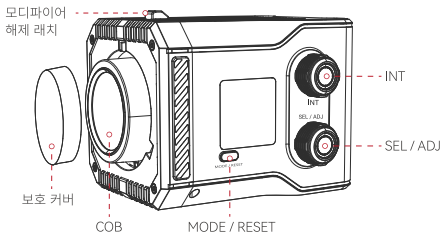

## 설치 설명서

1. 렌즈 보호 커버를 넣고 빼려면 화살표 방향을 따라가세요. 실리콘 보호 커버를 따로 빼거나 빼실 수 있습니다.

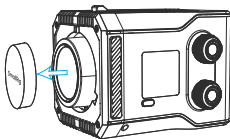

2. S-마운트 조명 제어 액세서리 설치 및 제거:

미니 베이요넷 조명 제어 액세서리 설치 및 제거: 미니 표준 커버를 예로 들어 미니 표준 커버를 씌웁니다. 램프 본체 전면 커버에 있는 미니 총검을 시계 반대 방향으로 돌려 설치할 수 있습니다. 액세서리 해제 버튼을 클릭한 후 시계 방향으로 돌리세요. 미니 표준 커버를 핀으로 돌려서 제거하세요.

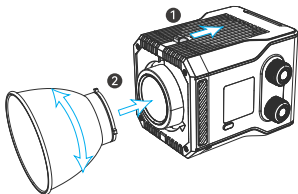

3. 램프 본체를 램프 스탠드에 고정합니다.

먼저 RC 60C 바닥에 있는 1/4" 나사산 구멍을 통과한 다음, 지지대를 램프 본체에 연결한 다음 라이트 스탠드에 설치하고 RC 60C의 조명 각도를 조절해 보세요. 마지막으로 지지 기둥의 손잡이로 잠급니다.

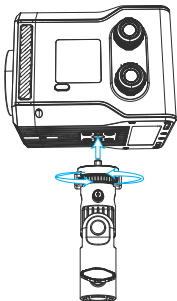

4. RC 60C 하단을 통해 램프 본체를 핸들에 고정합니다.  
1/4인치 나사 구멍, 핸들을 시계 방향으로 돌려 연결  
램프 본체.

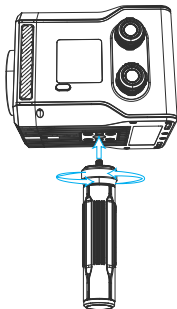

5. 부드러운 빛 우산 설치: 부드러운 빛 우산의 손잡이를 우산 구멍에 삽입하고 우산 구멍  
측면에 있는 손잡이를 잠급니다.

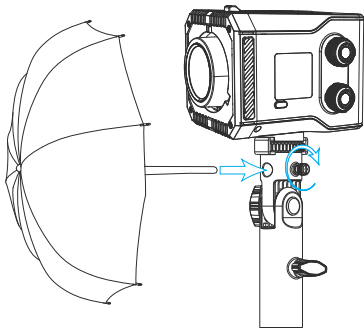

6. 창의적인 설치 방법: 매직암/계발톱 등의 액세서리를 유연하게 사용하여 RC 60C를  
연결할 수 있습니다. 하단의 1/4" 나사산 포트는 조명스탠드를 설치하기 불편한 곳에 조명을  
사용하는 용도로 사용됩니다.

## 작동 방법

1. ON/OFF: 조명을 켜고 INT 노브를 3초 이내에 한 바퀴 돌립니다(3초 이내에 한 바퀴가 되지 않으면 다시 돌리십시오). 그러면 메인 화면으로 들어갑니다.



2. CCT/HSI/FX/GEL/RGBCW 전환: "MODE/RESET" 버튼을 짧게 누르십시오.



3. ECO 모드: "ECO" 버튼을 2초 동안 눌러서 ECO 모드와 일반 모드 사이를 전환합니다. ECO 모드에서는 RC 60C의 전력 출력이 60%로 제한되며, 대기 시간을 최대 75분까지 연장할 수 있습니다.

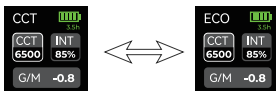

## 세부 작동

### 1. CCT 모드

#### (1) INT 조정:

"INT" 노브를 천천히 돌리면 INT가  $\pm 1\%$ 로 조정됩니다; "INT" 노브를 빠르게 돌리면 INT가  $\pm 10\%$ 로 조정됩니다; "INT" 노브를 누르면 INT가 20%, 40%, 60%, 80% 및 100%로 변경됩니다.

주의: INT는 모든 모드에서 별도로 제어됩니다.

#### (2) CCT와 G/M:

"SEL / ADJ"를 눌러 CCT와 G/M 사이를 전환합니다, "SEL / ADJ"를 천천히 돌리면 CCT가  $\pm 100\text{K}$ 로 조정됩니다; 노브를 빠르게 돌리면 CCT가  $\pm 1000\text{K}$ 로 조정됩니다; CCT 범위는 2500K에서 10000K입니다.

G/M 모드에서는 "SEL / ADJ"를 돌려 G/M이 0.1 단위로 조정되며 범위는 -1에서 1까지입니다.

## 2. HSI 모드







### (1) HUE/SAT:

"SEL / ADJ"를 눌러 HUE와 SAT 사이를 전환합니다. 노브를 돌려 숫자를 조정합니다. HUE 범위는 0° ~ 360° 이며, SAT 범위는 0~100% 입니다.

## 3. FX 모드

### (1) FX/CCT/FRQ:

"SEL / ADJ"를 눌러 FX, CCT, FRQ 사이를 전환합니다. 노브를 돌려 FX와 CCT를 조정합니다. 11가지 FX는 다음과 같습니다:

Paparazzi	Television	Falty bulb	Lightning	Breathing	Flickering
					

Party	Flame	Fireworks	Police Car	CCT Cycle	Color Cycle
					

### (2) FRQ 조정:

"SEL / ADJ"를 돌려 "FRQ"를 조정합니다. FRQ는 ±1 단위로 조정되며 범위는 1에서 10까지입니다.

## 4. GEL 모드

### (1) LEE / ROSCO

"SEL / ADJ" 노브를 눌러 LEE와 ROSCO 사이를 전환합니다. 노브를 돌려 젤을 선택합니다. LEE (Full CTO, 1/2 CTO, 1/4 CTO, 1/8 CTO, Full CTS, 1/2 CTS, 1/4 CTS, 1/8 CTS)

-총 8종

ROSCO (Full CTB, 1/2 CTB, 1/4 CTB, 1/8 CTB, Full CTO, 1/2 CTO, 1/4 CTO, 1/8 CTO)

-총 8종

## 5. RGBCW 모드

"SEL / ADJ"를 눌러 R/G/B/C/W 사이를 전환합니다. 노브를 돌려 숫자를 변경합니다. R/G/B 범위는 0~255이며, C/W 범위는 0~100입니다.

## 충전 및 유지보수

지원되는 충전 프로토콜은 다음과 같습니다:

PD3.0: 5V / 3A, 9V / 3A, 12V / 3A, 15V / 3A, 20V / 5A,

QC2.0 / AFC / FCP : 5V / 3A, 9V / 2A, 12V / 1.5A

APPLE-2.4A: 5V / 2.4A

### 1. 전원 켜진 상태에서 충전

충전기를 RC 60C와 C-C USB PD 충전 케이블로 연결합니다. 화면에 "DC in XXw" (XX는 어댑터의 정격 출력 전력을 나타냄) 가 표시됩니다.



### 2. 전원 꺼진 상태에서 충전



### 3. 배터리 표시 기능:

배터리가 방전 중일 때, 배터리 아이콘 아래에 남은 사용 시간이 표시됩니다.

배터리 수준 표시 방법은 다음과 같습니다:

0-2%	3-25%	26-50%	51-75%	76-100%

배터리 전압이 11.7V 이하일 때, 화면에 "Low Battery! Please charge!"가 표시되며, 5초 후에 기어가 꺼집니다.



### 4. 과열 보호 기능

배터리 온도가 62°C/63°C/64°C에 도달하면 출력이 80%/65%/50%로 줄어듭니다. 터리 온도가 65°C를 초과하면 조명이 자동으로 꺼지고 "Overheat" 경고가 표시됩니다. COB의 온도가 100°C에 도달하면 출력 전력이 70%로 줄어듭니다.

고온이 1분 동안 지속되면 조명이 꺼지고 "Overheat"가 표시됩니다. 배터리/조명 온도가 식은 후, 조명을 재시작하여 작동을 재개할 수 있습니다.



스크린에 “Sensor error”가 표시되면 조명의 열 센서가 고장났음을 의미합니다. 조명이 멈출 것입니다. 구매한 대리점에 연락하여 애프터서비스를 받으세요.



출력 전력의 감소는 화면에 표시되며, 실제 출력 전력의 백분율이 이미지 중앙에 표시됩니다.

## 펌웨어 업그레이드

1. “MODE/RESET” 버튼을 길게 눌러 BLE를 리셋합니다. BLE 아이콘이 여섯 번 깜박이면 모바일의 BLE를 켜고, SmallGoGo 앱을 열어 조명과 연결합니다.
2. 펌웨어 업그레이드가 필요할 때는 SmallGoGo 앱에 무선으로 연결합니다. 업그레이드 진행 상황이 표시됩니다.



펌웨어 업그레이드 성공

## 사양

힘	63W
냉각 방식	능동 냉각
CCT 범위	2500K - 10000K
충전 전력 / 전류	48W / 3A
용량	14.6V / 3400mAh / 49.64Wh
운영 시간	전원 공급 장치 최대 45분, ECO 모드 75분
팬 소음	전체 전력 26dB, ECO 모드 23dB
치수	120.0 × 95.0 × 80.0mm
무게	700.0 ± 10.0g

## 밝기 테스트 데이터 테이블

CCT	거리	INT
3200K	1m	2030Lux
5600K	1m	2350Lux
6900K	1m	2430Lux
R	1m	257Lux
G	1m	1120Lux
B	1m	266Lux

\* 밝기 데이터는 평균 데이터이며 다른 램프의 밝기는 다 양합니다.

# Service & Warranty

---

Please keep your original receipt and guarantee card. Be sure the dealer has written on it the date of purchase and SN of the product. These are required for warranty service.

## After-sale Warranty Terms

SmallRig products are entitled to warranty services as of the date of payment.

- Electronic products (except V mount battery): 1-year warranty.
- V mount battery: 2-year warranty.
- Non-electronic products: 2-year warranty.

Note: In case of any conflict between our warranty period policy and applicable laws and regulations of the country / region where the products are sold, the latter shall prevail.

## This Warranty Does Not Cover

1. If users fail to adhere to the "Operating Instruction" or any "Warnings" stated in the user manual, resulting in a quality failure, it falls outside the scope of warranty coverage.
2. The product identification or SN label is removed or defaced in any way.
3. Product damage caused by problems not attributable to the quality of the products such as improper use of the products.
4. Product damage caused by unauthorized modification, disassembly, repair and other acts.
5. Product damage caused by fires, floods, lightning and other force majeure factors.

## Warranty Mode

- For the products within the scope of warranty, SmallRig will repair or replace them on the basis of specific failures; the repaired / replaced products / parts are entitled to the remaining part of the original warranty period.

## Contact Information

- You're advised to contact the online customer service personnel of corresponding shopping platform and submit a repair service application.
- You may also apply for repair service through SmallRig's service email.

Service Email: [support@smallrig.com](mailto:support@smallrig.com)

EC	REP	Sea&Mew Accounting Ltd, Electric Avenue Vision 25, London, Enfield EN3 7GD, Billy Han, <a href="mailto:info@seamew.net">info@seamew.net</a>
----	-----	---

UK	REP	GAVIMOSA CONSULTORIA, SOCIEDAD LIMITADA, CASTELLANA 9144, 28046 Madrid, Jorge Wilson, <a href="mailto:compliance.gavimosa@outlook.com">compliance.gavimosa@outlook.com</a>
----	-----	--

# 保修条款

---

请保留您的原始购买单据及保修卡,同时包含您的购买日期、产品序列号等,这些资料质保服务时均需要提供。

## 售后质保条款

SmallRig产品自下单付款之日起享有质保服务。

- 电子产品(除V口电池): 1年质保。
- V口电池: 2年质保。
- 非电子产品: 2年质保。

注:若销售地国家或地区的适用法律法规有冲突的,以销售地国家或地区有关质保期的法律法规为准。

## 质保无效说明

1. 当用户违反操作指引或用户手册中“重要提示”任何一条导致的质量失效,不在质保范围内。
2. 产品序列号标识已经被撕毁或无法辨识,不在质保范围。
3. 产品使用不当等非产品本身质量问题,而造成的产品损坏,不在质保范围。
4. 非官方指导的私自改装、拆解、维修等行为而造成的损坏,不在质保范围。
5. 因火灾、水灾、雷击等不可抗力造成的产品损坏,不在质保范围。

## 维修方式

·属于质保范围的,SmallRig根据产品具体的故障对产品进行维修或更换;维修后的产品/部件享受原有保修期的剩余时长。

## 联系方式

- 建议您优先前往相应购买平台联系在线客服,提出产品维修申请。
- 您也可以通过 SmallRig 服务邮箱申请维修服务。

服务邮箱:support@smallrig.com

## Guarantee Card / 保修卡

ID No. ID 编号	
Item Name 产品名称	
Purchase Date 购买日期	
User Name 用户姓名	
Mobile 用户电话	
Address 用户地址	
Receipt 购买单据	

## FCC Statement

This equipment has been tested and found to comply with the limits for a Class B digital device, pursuant to part 15 of the FCC rules. These limits are designed to provide reasonable protection against harmful interference in a residential installation. This equipment generates, uses and can radiate radio frequency energy and, if not installed and used in accordance with the instructions, may cause harmful interference to radio communications. However, there is no guarantee that interference will not occur in a particular installation. If this equipment does cause harmful interference to radio or television reception, which can be determined by turning the equipment off and on, the user is encouraged to try to correct the interference by one or more of the following measures:

- Reorient or relocate the receiving antenna.
- Increase the separation between the equipment and receiver.
- Connect the equipment into an outlet on a circuit different from that to which the receiver is connected.
- Consult the dealer or an experienced radio/TV technician for help.

To assure continued compliance, any changes or modifications not expressly approved by the party.

Responsible for compliance could void the user's authority to operate this equipment. (Example- use only shielded interface cables when connecting to computer or peripheral devices).

This equipment complies with Part 15 of the FCC Rules. Operation is subject to the following two conditions:

- (1) This device may not cause harmful interference, and
- (2) This device must accept any interference received, including interference that may cause undesired operation.

## ISED Statement

English: This device contains licence-exempt transmitter(s)/receiver(s) that comply with Innovation, Science and Economic Development Canada's licence-exempt RSS(s). Operation is subject to the following two conditions:

- (1) This device may not cause interference.
- (2) This device must accept any interference, including interference that may cause undesired operation of the device.

French: Cet appareil contient des émetteurs/récepteurs exempts de licence qui sont conformes aux CNR exempts de licence d'Innovation, Sciences et Développement économique Canada. Le fonctionnement est soumis aux deux conditions suivantes:

- (1) Cet appareil ne doit pas causer d'interférences.
- (2) Cet appareil doit accepter toute interférence, y compris les interférences susceptibles de provoquer un fonctionnement indésirable de l'appareil.

This device meets the exemption from the routine evaluation limits in section 2.5 of RSS 102 and compliance with RSS 102 RF exposure, users can obtain Canadian information on RF exposure and compliance. cet appareil est conforme à l'exemption

des limites d'évaluation courante dans la section 2.5 du cnr - 102 et conformité avec rss 102 de l'exposition aux rf, les utilisateurs peuvent obtenir des données canadiennes sur l'exposition aux champs rf et la conformité.

This equipment complies with Canada radiation exposure limits set forth for an uncontrolled environment. This equipment should be installed and operated with minimum distance 0cm between the radiator & your body.

Cet équipement doit être installé et utilisé avec une distance minimale de 0cm entre le radiateur et votre corps.

Cet équipement est conforme Canada limites d'exposition aux radiations dans un environnement non contrôlé.



WE ARE HERE FOR YOU  
服务与支持



ETICETTATURA AMBIENTALE  
ENVIRONMENTAL LABELING

## LQ-B450-18

HVIN: RC 60C

FCC ID : 2BC2U-RC60C

IC: 31675-RC60C

CMIIT ID: 24J44G01R600



中国制造  
Made in China



**FR**  
Cet appareil, ses accessoires, cordons et batteries se recyclent

À DÉPOSER EN MAGASIN

ou

À DÉPOSER EN DÉCHÈTERIE

Points de collecte sur [www.quefairedemesdechets.fr](http://www.quefairedemesdechets.fr)  
Privilégiez la réparation ou le don de votre appareil !



**FR**  
**LE TRI + FACILE**



Séparez les éléments avant de trier



PAP

