



User Guide

Kasa Spot Pan Tilt, 24/7 Recording
EC70

Contents

About This Guide	1
Introduction	2
Appearance	3
Set Up Your Camera	4
Authentication	6

About This Guide

This guide provides a brief introduction to the Kasa Spot Pan Tilt and the Kasa Smart app, as well as regulatory information.

Features available in Kasa Smart may vary by model and software version. Kasa Smart availability may also vary by region or ISP. All images, steps, and descriptions in this guide are only examples and may not reflect your actual Kasa Smart experience.

Conventions

In this guide, the following convention is used:

Convention	Description
Teal	Key information appears in teal, including management page text such as menus, items, buttons and so on.
<u>Underline</u>	Hyperlinks are in teal and underlined. You can click to redirect to a website.

More Info

- Specifications can be found on the product page at <https://www.tp-link.com>.
- Our Technical Support and troubleshooting information can be found at <https://www.tp-link.com/support/>.
- A TP-Link Community is provided for you to discuss our products at <https://community.tp-link.com>.
- Frequently Asked Questions (FAQs) can be found at <https://www.tp-link.com/support/faq/>.

Introduction

With the Kasa Spot Pan Tilt connected to your home network, you can get the full picture of any space in your apartment, dorm or home. With a 360° horizontal view and 113° vertical view, the Pan Tilt has everything covered. With Motion Tracking and Patrol Mode, track activity from beginning to end and set multiple distinct viewpoints for your camera to monitor at set intervals.

- **Crystal Clear Video** – Sharp and clear 1080p Full HD provides high-quality video right in the palm of your hand.
- **Pan and Tilt** – Swipe up, down, left and right on your phone to rotate and set the camera's point of view.
- **Motion Tracking** – When motion activity is detected, Kasa Spot Pan Tilt tracks and follows the subject to keep it within the camera's field of view.
- **Secure Local Storage** – Save your footage on a microSD card and play back with your Kasa Smart app.
- **Patrol Mode** – Set 4 distinct viewpoints and program your pan tilt camera to keep an eye on each region at intervals of your choosing.
- **Night Vision** – Even in the dark, the camera has Night Vision up to 30 feet. Never miss a thing at night and still get the same high-quality video you're used to.
- **Instant Activity Alerts** – No need to check your Kasa Spot Pan Tilt throughout the day. Get automatic alerts when it detects motion. Take quick action when you see your pet on the couch, a roommate walking through your room, or an intruder enter your front door.
- **Two-Way Audio** - Use crisp two-way audio to communicate with nosy roommates, family or even mischievous pets.
- **Activity Zones** - Control what alerts you receive by creating up to 16 custom activity zones, at no charge, around areas that are important to you.
- **24/7 Recording** - Support continuous video recording with a SD card inserted to your Kasa Spot Pan Tilt.

Appearance

Kasa Spot Pan Tilt has a system LED that changes color according to its status, a lens, microphone, speaker, micro USB port, a SD card slot and a RESET button. Refer below for details.

System LED

- **Solid orange:**
Rebooting
- **Blinking orange and green:**
Ready for setup
- **Blinking red:**
Connecting to Wi-Fi
- **Blinking green:**
Connected to Wi-Fi
- **Solid green:**
Connected to the cloud
- **Blinking orange:**
Camera resetting

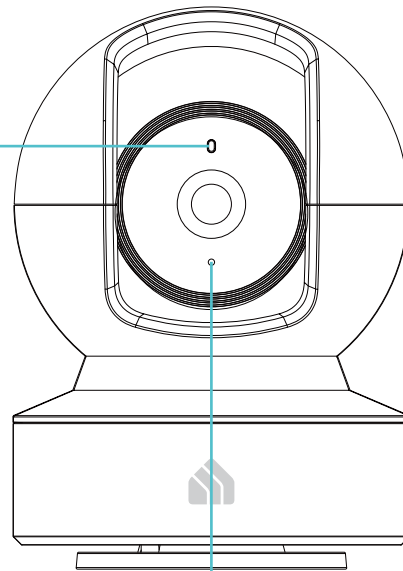

Microphone

Built-in internal microphone.
Note: Do NOT insert objects into the hole.

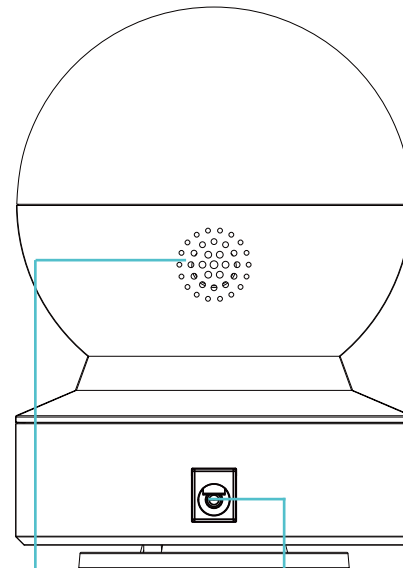

Speaker

The sound comes out of the camera.

Power Port

Connect the power adapter provided.

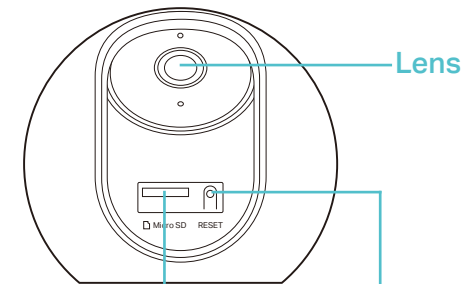

microSD Card Slot

Insert a microSD card* for recording.
*microSD card not included.

RESET Button

Tilt your camera lens up to find the RESET button.
Press and hold the reset button for 5 seconds until the LED blinks orange and green.

Set Up Your Camera

Follow the steps below to get started with your new camera.

Step 1. Download Kasa

Get the [Kasa Smart](#) app from the App Store or Google Play, or by scanning the QR code below.



Step 2. Log In

Open the app, and log in with your TP-Link ID. If you don't have an account, create one first.

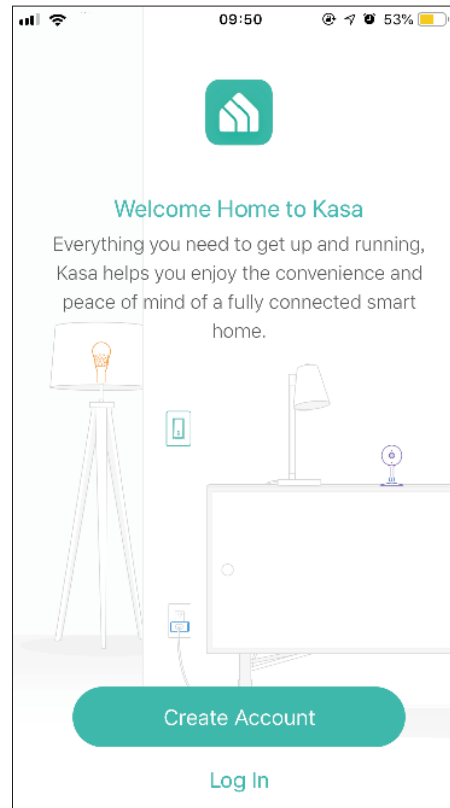

Step 3. Start Setup

Tap the ⊕ button in the Kasa app and select [Cameras > Kasa Spot Pan Tilt](#).

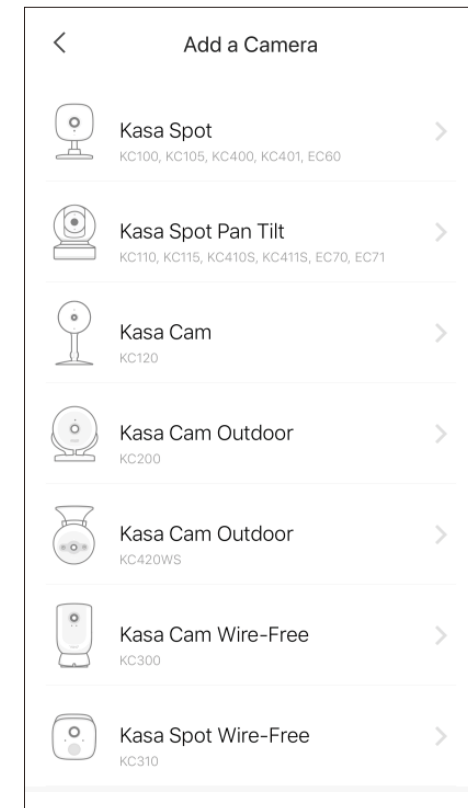

Step 4. Configure Camera

Follow app instructions to configure your camera and add it to your home network.

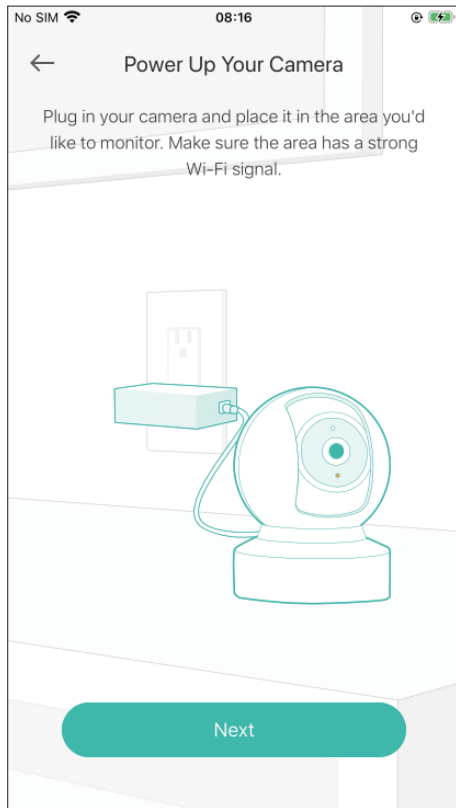

Step 5. Place Camera

Place your camera on a flat surface, or install it on a wall or ceiling with the provided indicator label and mounting screws.

- For soft surface: Directly screw the screws in.
- For cement wall: Drill two holes* with the help of indicator label, insert the plastic expansion tubes into holes and screw the mounting screws into the expansion tubes.

* Diameter of the holes: 6 mm (15/64 in.)

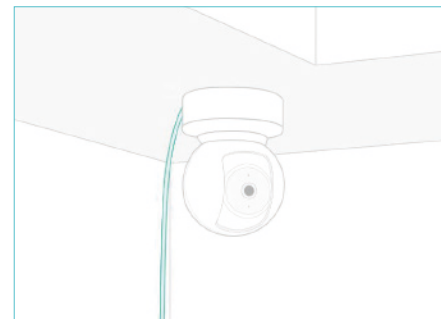
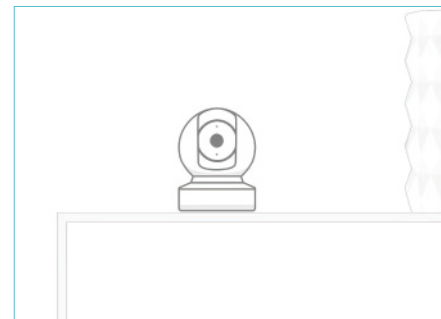

Unit: mm

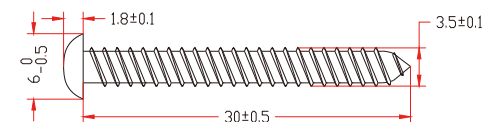

Authentication

FCC compliance information statement



Product Name: Kasa Spot Pan Tilt, 24/7 Recording

Model Number: EC70

Component Name	Model
I.T.E. Power Supply	T090060-2B1

Responsible Party:

TP-Link USA Corporation

Address: 10 Mauchly, Irvine, CA 92618

Website: <http://www.tp-link.com/us/>

Tel: +1 626 333 0234

Fax: +1 909 527 6804

E-mail: sales.usa@tp-link.com

This equipment has been tested and found to comply with the limits for a Class B digital device, pursuant to part 15 of the FCC Rules. These limits are designed to provide reasonable protection against harmful interference in a residential installation. This equipment generates, uses and can radiate radio frequency energy and, if not installed and used in accordance with the instructions, may cause harmful interference to radio communications. However, there is no guarantee that interference will not occur in a particular installation. If this equipment does cause harmful interference to radio or television reception, which can be determined by turning the equipment off and on, the user is encouraged to try to correct the interference by one or more of the following measures:

- Reorient or relocate the receiving antenna.
- Increase the separation between the equipment and receiver.
- Connect the equipment into an outlet on a circuit different from that to which the receiver is connected.
- Consult the dealer or an experienced radio/ TV technician for help.

This device complies with part 15 of the FCC Rules. Operation is subject to the following two conditions:

1. This device may not cause harmful interference.
2. This device must accept any interference received, including interference that may cause undesired operation.

Any changes or modifications not expressly approved by the party responsible for compliance could void the user's authority to operate the equipment.

Note: The manufacturer is not responsible for any radio or TV interference caused by unauthorized modifications to this equipment. Such modifications could void the user's authority to operate the equipment.

FCC RF Radiation Exposure Statement

This equipment complies with FCC RF radiation exposure limits set forth for an uncontrolled environment. This device and its antenna must not be co-located or operating in conjunction with any other antenna or transmitter.

"To comply with FCC RF exposure compliance requirements, this grant is applicable to only Mobile Configurations. The antennas used for this transmitter must be installed to provide a separation distance of at least 20 cm from all persons and must not be co-located or operating in conjunction with any other antenna or transmitter."

We, **TP-Link USA Corporation**, has determined that the equipment shown as above has been shown to comply with the applicable technical standards, FCC part 15. There is no unauthorized change is made in the equipment and the equipment is properly maintained and operated.

Issue Date: 2024-07-05

FCC compliance information statement

Product Name: I.T.E. Power Supply

Model Number: T090060-2B1

Responsible Party:

TP-Link USA Corporation

Address: 10 Mauchly, Irvine, CA 92618

Website: <http://www.tp-link.com/us/>

Tel: +1 626 333 0234

Fax: +1 909 527 6804

E-mail: sales.usa@tp-link.com

This equipment has been tested and found to comply with the limits for a Class B digital device, pursuant to part 15 of the FCC Rules. These

limits are designed to provide reasonable protection against harmful interference in a residential installation. This equipment generates, uses and can radiate radio frequency energy and, if not installed and used in accordance with the instructions, may cause harmful interference to radio communications. However, there is no guarantee that interference will not occur in a particular installation. If this equipment does cause harmful interference to radio or television reception, which can be determined by turning the equipment off and on, the user is encouraged to try to correct the interference by one or more of the following measures:

- Reorient or relocate the receiving antenna.
- Increase the separation between the equipment and receiver.
- Connect the equipment into an outlet on a circuit different from that to which the receiver is connected.
- Consult the dealer or an experienced radio/ TV technician for help.

This device complies with part 15 of the FCC Rules. Operation is subject to the following two conditions:

1. This device may not cause harmful interference.
2. This device must accept any interference received, including interference that may cause undesired operation.

Any changes or modifications not expressly approved by the party responsible for compliance could void the user's authority to operate the equipment.

We, **TP-Link USA Corporation**, has determined that the equipment shown as above has been shown to comply with the applicable technical standards, FCC part 15. There is no unauthorized change is made in the equipment and the equipment is properly maintained and operated.

Issue Date: 2024-07-05

NCC Notice

注意!

取得審驗證明之低功率射頻器材，非經核准，公司、商號或使用者均不得擅自變更頻率、加大功率或變更原設計之特性及功能。

低功率射頻器材之使用不得影響飛航安全及干擾合法通信；經發現有干擾現象時，應立即停用，並改善至無干擾時方得繼續使用。

前述合法通信，指依電信管理法規定作業之無線電通信。

低功率射頻器材須忍受合法通信或工業、科學及醫療用電波輻射性電機設備之干擾。為避免本器材影像畫面遭偷窺或擷取，本器材使用者應先修改預設密碼，並定期更新密碼。

BSMI Notice

安全諮詢及注意事項

- 請使用原裝電源供應器或只能按照本產品注明的電源類型使用本產品。
- 清潔本產品之前請先拔掉電源線。請勿使用液體、噴霧清潔劑或濕布進行清潔。
- 注意防潮，請勿將水或其他液體潑灑到本產品上。
- 插槽與開口供通風使用，以確保本產品的操作可靠並防止過熱，請勿堵塞或覆蓋開口。
- 請勿將本產品置放於靠近熱源的地方。除非有正常的通風，否則不可放在密閉位置中。
- 請不要私自拆開機殼或自行維修，如產品有故障請與原廠或代理商聯繫。

限用物質含有情況標示聲明書

設備名稱：Kasa Spot Pan Tilt, 24/7 Recording Equipment name		型號（型式）：EC70 Type designation (Type)				
單元 Unit	限用物質及其化學符號 Restricted substances and its chemical symbols					
	鉛 Lead (Pb)	汞 Mercury (Hg)	鎘 Cadmium (Cd)	六價鉻 Hexavalent chromium (Cr+6)	多溴聯苯 Polybrominated biphenyls (PBB)	多溴二苯醚 Polybrominated diphenyl ethers (PBDE)
PCB	○	○	○	○	○	○
外殼	○	○	○	○	○	○

電源供應器	—	○	○	○	○	○
其他及其配件	—	○	○	○	○	○









備考 1. “超出 0.1 wt %” 及 “超出 0.01 wt %” 係指限用物質之百分比含量超出百分比含量基準值
 Note 1: “Exceeding 0.1 wt %” and “exceeding 0.01 wt %” indicate that the percentage content of the restricted substance exceeds the reference percentage value of presence condition.
 備考 2. “○” 係指該項限用物質之百分比含量未超出百分比含量基準值。
 Note 2: “○” indicates that the percentage content of the restricted substance does not exceed the percentage of reference value of presence.
 備考 3. “—” 係指該項限用物質為排除項目。
 Note 3: The “—” indicates that the restricted substance corresponds to the exemption.

Safety Information

- Keep the device away from water, fire, humidity or hot environments.
- Do not attempt to disassemble, repair, or modify the device.
- Do not use damaged charger or USB cable to charge the device.
- Do not use any other chargers than those recommended
- Do not use the device where wireless devices are not allowed.
- Adapter shall be installed near the equipment and shall be easily accessible.
- Use only power supplies which are provided by manufacturer and in the original packing of this product. If you have any questions, please don't hesitate to contact us.
- This product uses radios and other components that emit electromagnetic fields. Electromagnetic fields and magnets may interfere with pacemakers and other implanted medical devices. Always keep the product and its power adapter more than 15 cm (6 inches) away from any pacemakers or other implanted medical devices. If you suspect your product is interfering with your pacemaker or any other implanted medical device, turn off your product and consult your physician for information specific to your medical device.
- Operating Temperature: 0 °C~ 40 °C (32°F ~ 104°F)

Please read and follow the above safety information when operating the device. We cannot guarantee that no accidents or damage will occur due to improper use of the device. Please use this product with care and operate at your own risk.

Explanation of the symbols on the product label

Symbol	Explanation
	Alternating current
	DC voltage
	Caution
	Operator's manual
	Class II equipment
	Polarity of output terminals
	Energy efficiency Marking
	Indoor use only
	<p>RECYCLING</p> <p>This product bears the selective sorting symbol for Waste electrical and electronic equipment (WEEE). This means that this product must be handled pursuant to European directive 2012/19/EU in order to be recycled or dismantled to minimize its impact on the environment.</p> <p>User has the choice to give his product to a competent recycling organization or to the retailer when he buys a new electrical or electronic equipment.</p>

