

# VZ-IPM SERIES

## 24" & 32" PROFESSIONAL IP INPUT MONITOR

---

### USER MANUAL



**ViewZ**<sup>®</sup>  
[www.viewzusa.com](http://www.viewzusa.com)

Please read this manual thoroughly before use, and keep it handy for future reference.

# CONTENTS

<b>Safety Instruction</b> .....	3
1. Mark Indication & Substance .....	4
2. Warning .....	4
3. Caution .....	5
4. Operational Temperature & Humidity .....	5
5. Dot Defect (dead pixel) of TFT .....	5
6. FCC RF INTERFERENCE STATEMENT .....	6
<b>Installation</b> .....	7
1. Package .....	7
2. Interface .....	8
<b>Function</b> .....	9
1. Monitor Button Function .....	10
2. Control and Function .....	10
3. Bosch Camera / Control and Function .....	36
<b>Mounting Guide</b> .....	51
<b>Specification</b> .....	52
<b>RMA</b> .....	53
<b>Warranty</b> .....	56

# SAFETY INSTRUCTION

## Important Safety Instruction

1. Read all warnings.
2. Follow all instructions to ensure longevity of monitor.
3. Do not place the monitor near water.
4. Clean only with dry cloth.
5. Do not block any ventilation openings. Install in accordance with the manufacturer's instructions.
6. Do not install near any heat sources such as radiators, heat registers, stoves, or other heat generating devices.
7. Do not override the safety purpose of the polarized or grounding-type plug.
8. A polarized plug has two blades with one wider than the other.
9. A grounding type plug has two blades and a third grounding prong.
10. The wide blade or the third prong are provided for your safety.
11. If the provided plug does not fit into your outlet, consult with electrician for replacement of the outlet.
12. Protect the power cord from being walked on or pinched particularly at plugs, convenience receptacles and the point where it connects to the monitor.
13. Only use attachment/accessories specified by the manufacturer.
14. Use only with the cart, stand, tripod, bracket or table specified by the manufacturer or sold with the monitor. When a cart is used, use caution when moving the cart & monitor in combination to avoid injuries.
15. Unplug the monitor during lightning storms or when unused for long periods of time.
16. Refer all servicing to qualified service personnel. Servicing is required when the monitor has been damaged in any way.



The monitor shall not be exposed to dripping or splashing and objects containing liquids, such as vases shall be placed near the monitor.

The monitor should have ample distance (e.g. 10cm) from the wall for sufficient ventilation.

# SAFETY INSTRUCTION

## Important Safety Instruction

### Mark Indication and Substance



CAUTION : TO REDUCE THE RISK OF ELECTRICAL SHOCK,  
DO NOT REMOVE COVER (OR BACK). NO USER  
SERVICEABLE PARTS INSIDE. REFER SERVICING TO  
QUALIFIED SERVICE PERSONNEL



This symbol is intended to alert the user to the presence of uninsulated & dangerous voltage within the monitor's enclosure that may be of sufficient magnitude to constitute a risk of electric shock to persons.



This symbol is intended to alert the user to the presence of important operating and maintenance (servicing) instructions in the literature accompanying the monitor.

### Warning

- Do not use damaged or loose cables and plug.
- Do not pull the plug out by the wire nor touch the plug with wet hands.
- Use only a properly grounded plug and receptacle.
- Do not connect too many extension cords or plugs to one outlet.
- Do not excessively bend the plug and wire.
- Do not disconnect the power cord while it's still plugged into the monitor.
- Do not place any heavy objects on the power cord. Damage to the cord may cause shock or fire.
- Never open the monitor. There are no user-serviceable parts inside and opening will void warranty.
- Removing covers may expose you to dangerous shock hazards or other risks.
- Keep any heating devices away from the power cable and monitor.
- Do not place the monitor near water.
- Do not insert objects of any kind into the monitor's open slots, as they may touch dangerous voltage points.
- Please follow the laws and regulations of your municipality to dispose of the tube properly.
- Do not use the monitor in high temperature, humid, dusty or oily areas.
- Do not install the monitor where it will be exposed to continual vibration.
- Keep the plastic packaging out of children's reach.
- If any damage is defected upon first opening the box, contact agency from which you bought the monitor directly.
- If your monitor does not operate normally – in particular, if there is any unusual sound or smell coming from the monitor – unplug it immediately and contact an authorized dealer or the service center.

# SAFETY INSTRUCTION

## Important Safety Instruction

### Caution

- If the connector between the plug and the pin is dusty or dirty, clean it properly using a dry cloth.
- Make sure to unplug the power cord before cleaning the monitor.
- Make sure to leave a gap between monitor and wall.
- Do not drop the monitor when moving it.
- Place your monitor in a location with low humidity and a minimum dust.
- Install the monitor base on a showcase or shelf so that the end of the base does not protrude from the showcase or shelf.
- Do not place the monitor on an unstable or small surface area.
- Do not install inside a vehicle.
- Disconnect the plug from the outlet during storms or lightning or if it has not been used for a long time.
- Do not try to move the monitor by pulling on the power cord.
- Do not cover the vents on the monitor.
- When moving the monitor, turn off and unplug the power cord. Make sure that all cables, including HDMI cable and cables connected to other devices, are disconnected before moving it.
- Place the monitor out of children's reach, as they could damage it by hanging onto it.

### Available Temperature & Humidity

- Operating Temperature for VZ-24IPM : 14°F ~ 122°F / -10°C ~ 50°C
- Operating Temperature for VZ-32IPM : 32°F ~ 140°F / 0°C ~ 60°C
- Operating Humidity : 20 ~ 70% RH

### Dot Defect (dead pixel) of TFT

ViewZ monitors are manufactured using high-end semiconductor technology with precision ratings of 99.9% and above. However, it may be the case that certain RGB and white pixels seem darker (or entirely unlit i.e. black).

Modern production methods cannot guarantee an absolute fault-free monitor. To this effect, no LED manufacturer can guarantee a defect free panel. A few isolated pixel or sub-pixel faults are considered tolerable and different policies exist that govern the amount of these tolerable values.

While most pixel faults occur in isolated regions, a cluster of dead pixels or sub-pixels can sometimes form for which a separate ruling applies. A cluster is defined as an area of 5x5 pixels. ViewZ's policy on pixel failure: either as an isolated fault or in the form of a cluster is outlined on the website: [www.viewzusa.com](http://www.viewzusa.com)

# FCC RF INTERFERENCE STATEMENT

## Note

This equipment has been tested and found to comply with the limits for a Class A digital device, pursuant to part 15 of the FCC Rules. These limits are designed to provide reasonable protection against harmful interference when the equipment is operated in a commercial environment.

This equipment generates, uses, and can radiate radio frequency energy and, if not installed and used in accordance with the instruction manual, may cause harmful interference to radio communications. Operation of this equipment in a residential area is likely to cause harmful interference in which case the user will be required to correct the interference at his own expense.

- Reorient or relocate the receiving antenna.
- Increase the separation between the equipment and receiver.
- Connect the equipment into an outlet on a circuit different from that to which the receiver is connected.
- Consult the dealer or an experienced radio, TV technician for help.
- Only shielded interface cable should be used.

Finally, any changes or modifications to the equipment by the user not expressly approved by the grantee or manufacturer could void the users authority to operate such equipment.

### ► DOC COMPLIANCE NOTICE

This digital apparatus does not exceed the Class A limits for radio noise emissions from digital apparatus set out in the radio interference regulation of Canadian Department of communications.

## Statement

- VGA and XGA are the registered trademark of IBM.
- VESA is the trademark of Video Electronics Standard Association.
- HDMI, HDMI logo and High-Definition Multimedia Interface (high definition multimedia digital interface) are the trademark or registered trademark of HDMI Licensing LLC.



If some company or product trademark is not particularly stated, the use of trademark has been fully recognized. Do not alter, decompile, disassemble, decode or conduct reverse engineering to the software installed in the product, or it can be deemed as breach of the law.

# INSTALLATION

## Installation Tools

The following tools may be required depending on your installation.

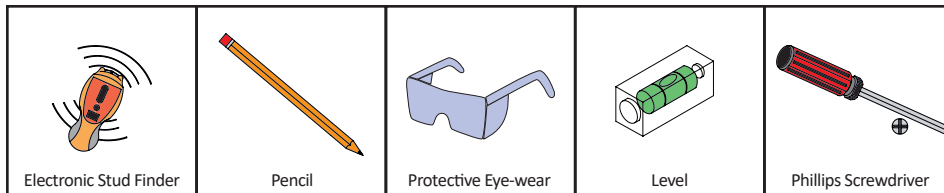

## Assembly Components - provided

Your ViewZ monitor is shipped with all proper installation hardware and components. If there are parts missing and/or damaged, please stop the installation and contact ViewZ USA at (888)-998-4399.



TFT-LED Monitor (Qty 1)  
Monitor Stand (Qty 1)



110V Power Cable (Qty 1)  
DC 12V Power Supply (Qty 1)



User Manual (Qty 1)



Remote Controller (Qty 1)  
(Without battery (AAA))

## Mounting Option

Your ViewZ monitor is compatible with ViewZ monitor mounts. For more information, please contact ViewZ USA at (888)-998-4399.

### Wall & Pole Mount

- |   |  |   |
|---|--|---|
| <ul style="list-style-type: none"> <li>Part # <b>WM05</b> VESA 75, 100<br/>15mm Low profile<br/><b>24IPM</b></li> </ul>                              | <ul style="list-style-type: none"> <li>Part # <b>WM11</b> VESA 50, 75, 100<br/>Tilting -20° ~ +20°<br/>Swivel -30° ~ +30°<br/><b>24IPM</b></li> </ul>             | <ul style="list-style-type: none"> <li>Part # <b>AM02-A</b> VESA 75 ~ 200<br/>Tilting -12° ~ +5°<br/>Swivel ± 90°<br/><b>24IPM &amp; 32IPM</b></li> </ul>  |
| <ul style="list-style-type: none"> <li>Part # <b>SCM-SQ</b> VESA 75, 100<br/>Tilting ± 90°<br/>Swivel 360°<br/>PAN 180°<br/><b>24IPM</b></li> </ul>  | <ul style="list-style-type: none"> <li>Part # <b>CMKIT-02</b> VESA 75 ~ 200<br/>Tilting -12° ~ +5°<br/>PAN Rotation 360°<br/><b>24IPM &amp; 32IPM</b></li> </ul>  |   |

# CONNECT EXTERNAL EQUIPMENTS

## 24" IPM Interface Input Ports

The following image is the description of interface input ports of IP Input Monitor.

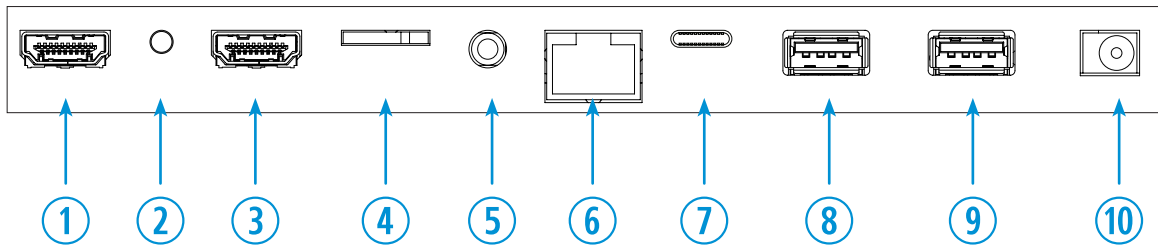

- |              |                                  |
|--------------|----------------------------------|
| 1. HDMI In   | 6. ETHERNET 10/100 (RJ 45) / PoE |
| 2. Reset     | 7. USB (Type C) In               |
| 3. HDMI Out  | 8. USB 3.0 (Type A) In           |
| 4. MICRO SD  | 9. USB 2.0 (Type A) In           |
| 5. Audio Out | 10. DC 12V In                    |

## 32" IPM Interface Input Ports

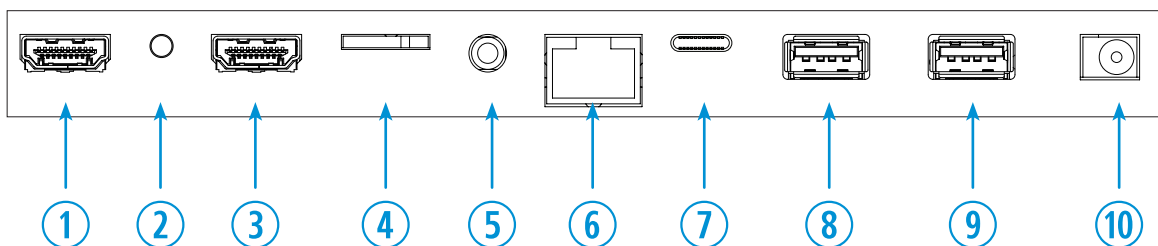

- |              |                            |
|--------------|----------------------------|
| 1. HDMI In   | 6. ETHERNET 10/100 (RJ 45) |
| 2. Reset     | 7. USB (Type C) In         |
| 3. HDMI Out  | 8. USB 3.0 (Type A) In     |
| 4. MICRO SD  | 9. USB 2.0 (Type A) In     |
| 5. Audio Out | 10. DC 12V In              |

# REMOTE FUNCTION

## Remote Controller

1. Power
2. Up
3. Left
4. Select
5. Right
6. Down
7. Recent Apps
8. N / A
9. Settings
10. Back
11. Home
12. Volume Up
13. Volume Down

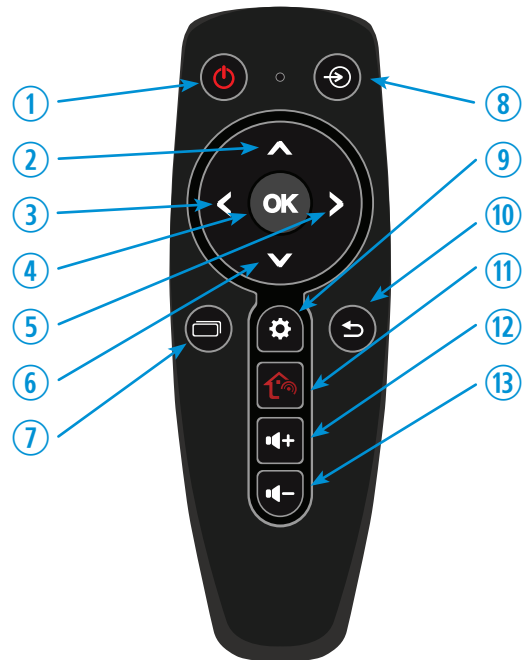

Display image, sound and custom settings can be adjusted in OSD (On Screen Display) menu by remote controller.  
To adjust monitor setting value :

1. Press the **'Settings'** button to enter the setup of running app
2. Press the **'Recent Apps'** button to select recent apps
3. Press the **'Home'** button to go directly to the home screen
4. Press the **'Back'** button to go back the previous screen
5. Press the **▲ / ▼ / ◀ / ▶** buttons to select the desired sub-menu
6. Press the **'OK'** button to select
7. Press the **'Volume Up & Down'** button to up / down audio volume

# CONTROL AND FUNCTION

## On Monitor, Button Control

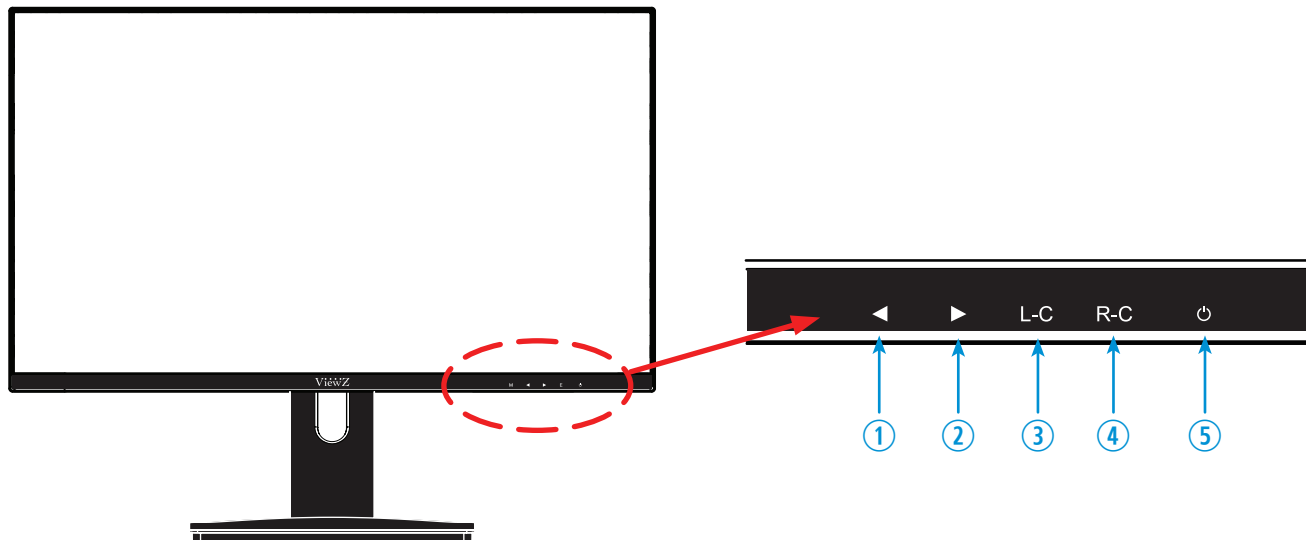

1. Left ◀ (Left Move)  
Move the selection to the left
2. Right ▶ (Right Move)  
Move the selection to the right
3. L-C (Left Click Function of Mouse)  
Same function of mouse left click
4. R-C (Right Click Function of Mouse)  
Same function of mouse right click
5. Power  
Monitor power on / off

# CONTROL AND FUNCTION

## Initial Setup - Launch Onvif IP Cam Viewer



- Click  on the desktop, you will see ViewZ's ONVIF IP Cam Viewer App. The App will be looks like below;

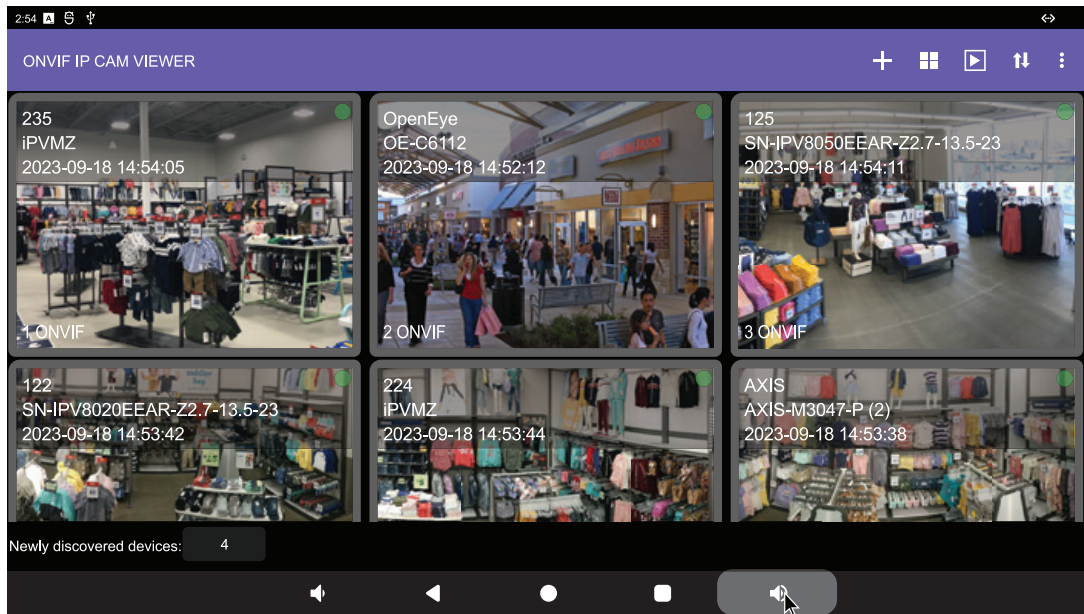

# CONTROL AND FUNCTION

## Initial Setup - Launch Onvif IP Cam Viewer

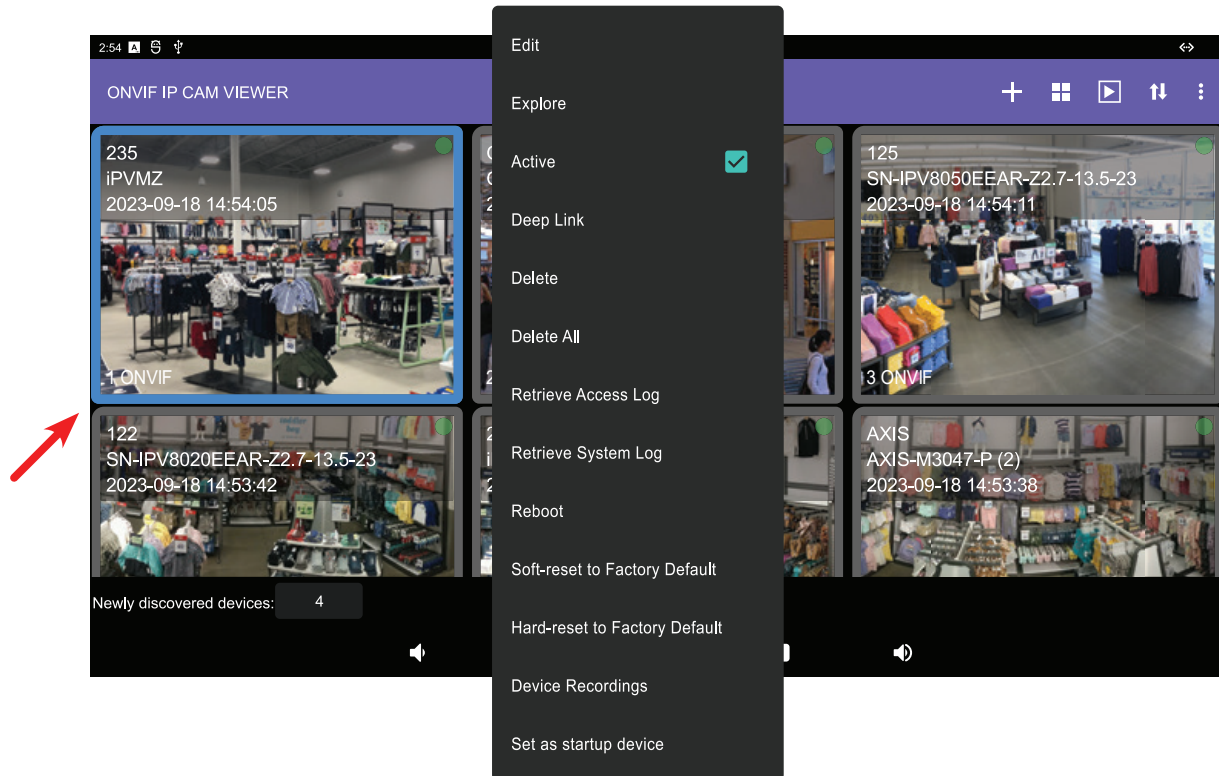

- Click & hold one of screens, then user will see a popup window which can control selected device (camera)
- **Edit** - edit the selected device (camera) information
- **Explore** - configure the entire feature of selected device (camera)
- **Active** - play & stop the live streaming of selected device (camera)
- **Deep Link** - not support
- **Delete** - delete the selected device (camera) from the list
- **Delete All** - delete all device (camera) from the list
- **Retrieve Access Log** - restore the selected device (camera) info
- **Retrieve System Log** - restore the entire system info
- **Reboot** - reboot the selected device (camera)
- **Soft-reset to Factory Default** - restore factory default
- **Hard-reset to Factory Default** - restore factory default
- **Device Recordings** - not support in this status. User can record a live video on multiview or sequential viewing mode
- **Set as startup device** - setup the selected device (camera) as the initial view when launching App

# CONTROL AND FUNCTION

## Initial Setup - VMS Shortcut Icon Folder

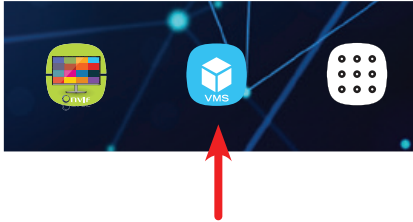

- Click  on the desktop, you will see the shortcut icons which administrator installed & added on this folder.

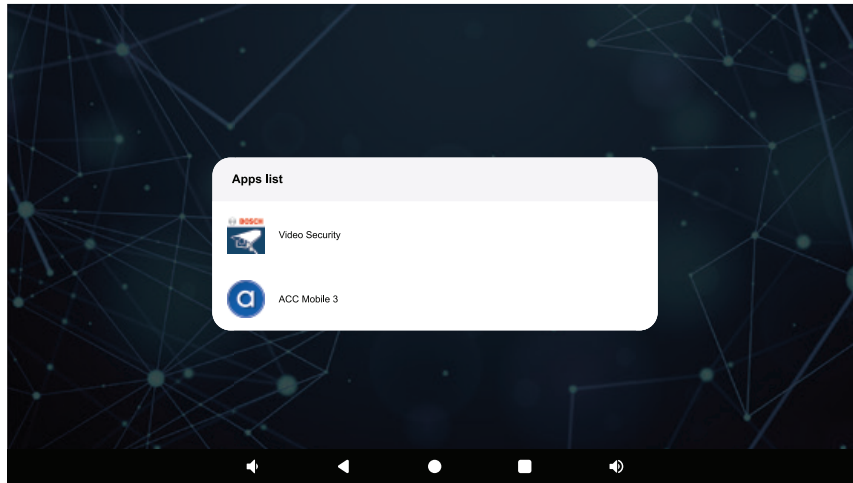

- User (administrator) can add this shortcut icon at the 'Settings'.

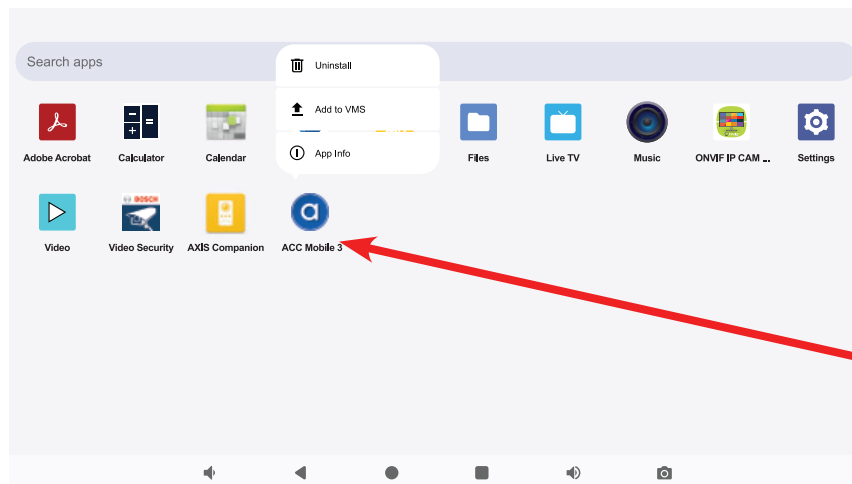

Click & hold to add the selected App on the VMS shortcut icon folder

- On the 'Settings', if user (administer) select an App and click & hold, user will see the selected App is added on VMS shortcut icon folder.

# CONTROL AND FUNCTION

## Initial Setup - Access Settings



- Click  on the desktop, you will see the Settings window. User (administrator) need to enter ID / PWD.
- The default ID / PWD is '**root / root**'.

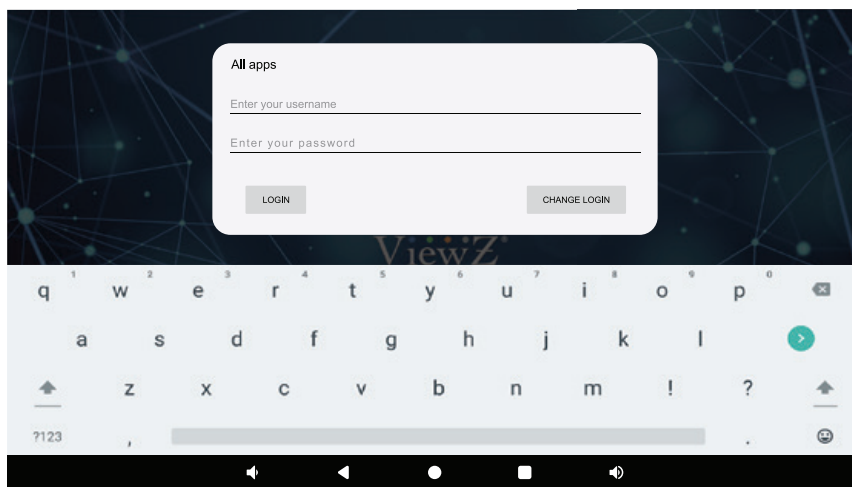



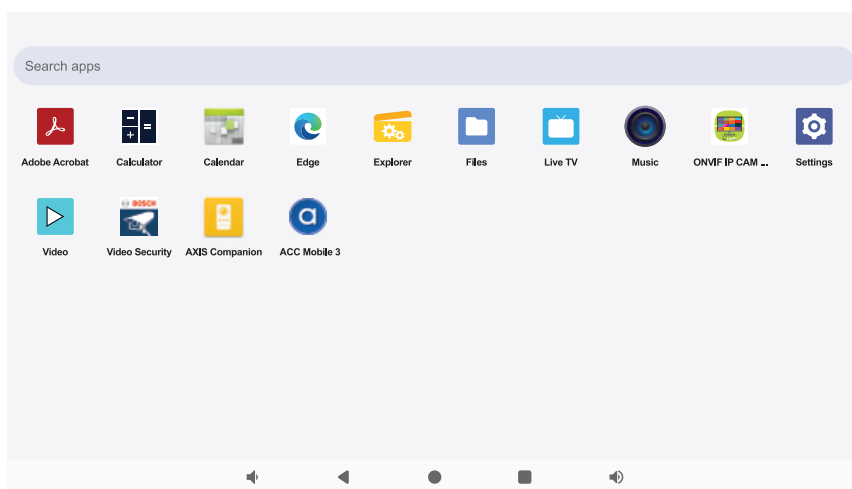



- On 'Settings', user can install App, export saved screenshots & recorded videos and change android setup.

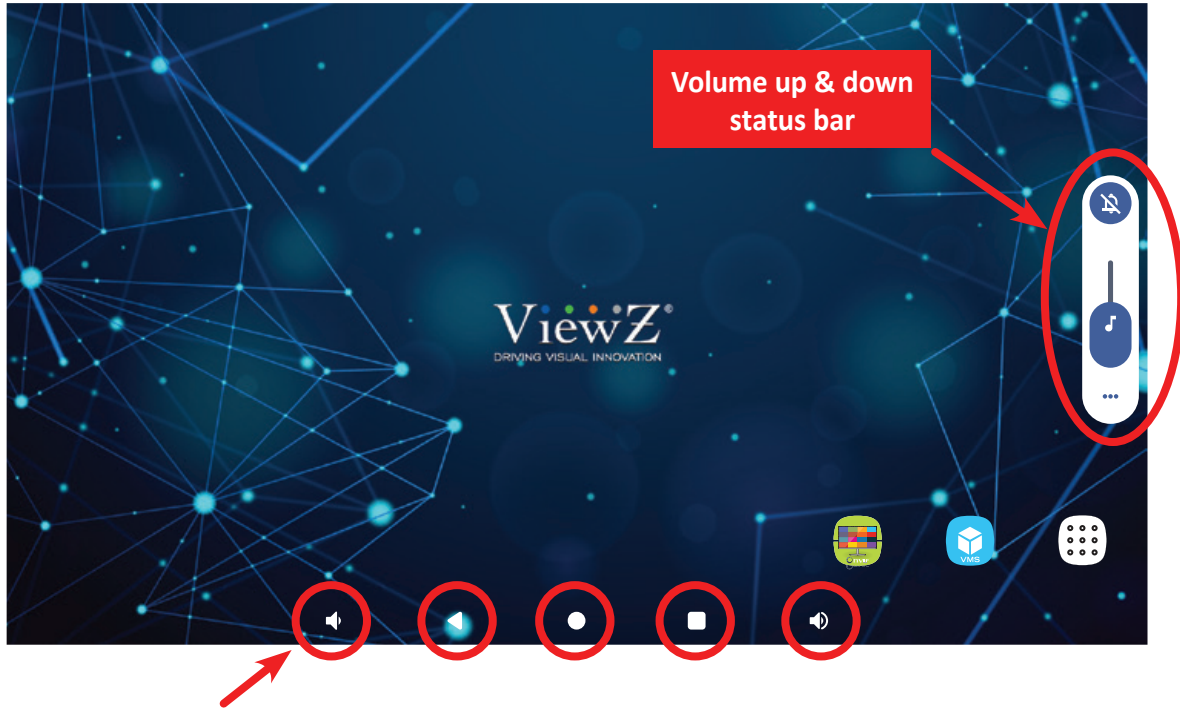

# CONTROL AND FUNCTION

## Initial Setup - Main Control Buttons



- Click  to volume down. Click  to volume up. When user click these buttons, user can see
- Click  to go back to previous menu.
- Click  to go back the home screen.
- Click  to see multi windows which show running apps.

# CONTROL AND FUNCTION

## Initial Setup - Switch Background Image

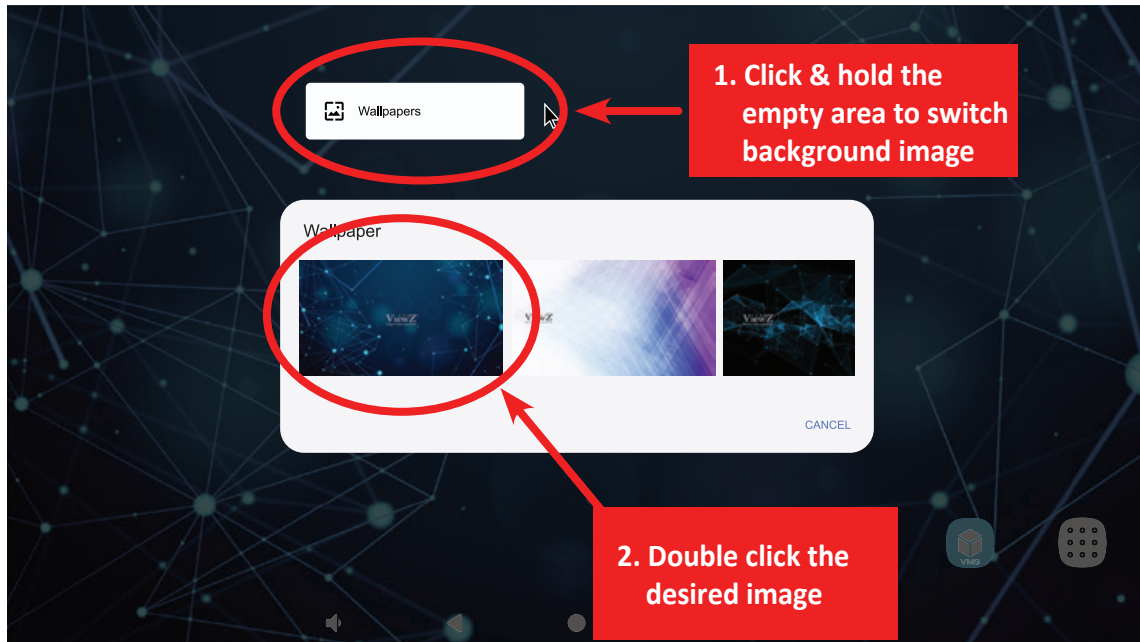

1. If user want to change the desktop background image, user needs to click & hold empty area of screen.
2. On 'Wallpapers' popup menu, click 'Wallpapers'
3. 'Wallpapers' window show background images.
4. Select and double click it. Then, the selected image will be displayed in the background.

# CONTROL AND FUNCTION

## After Setup - Saving the Configuration

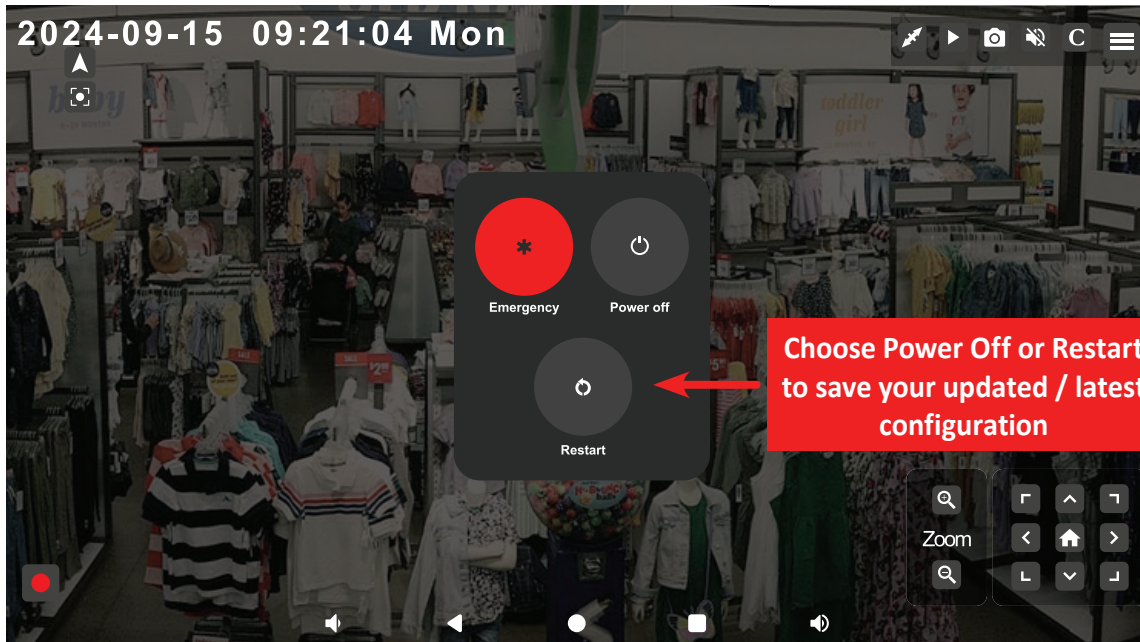

- After registering your camera view based on your desired configuration, power has to be turned off from the monitor physically pressing and holding  (Power) button for 10 seconds to pop menu below from the screenshot. User can select restart or power off option to save the latest / updated configuration. Please note that without this procedure, there is a high risk of the user losing the configured settings.



### Note

- In order to add another different channel or changing the configuration, requires above procedures to save your settings.

# CONTROL AND FUNCTION

## Add a Device

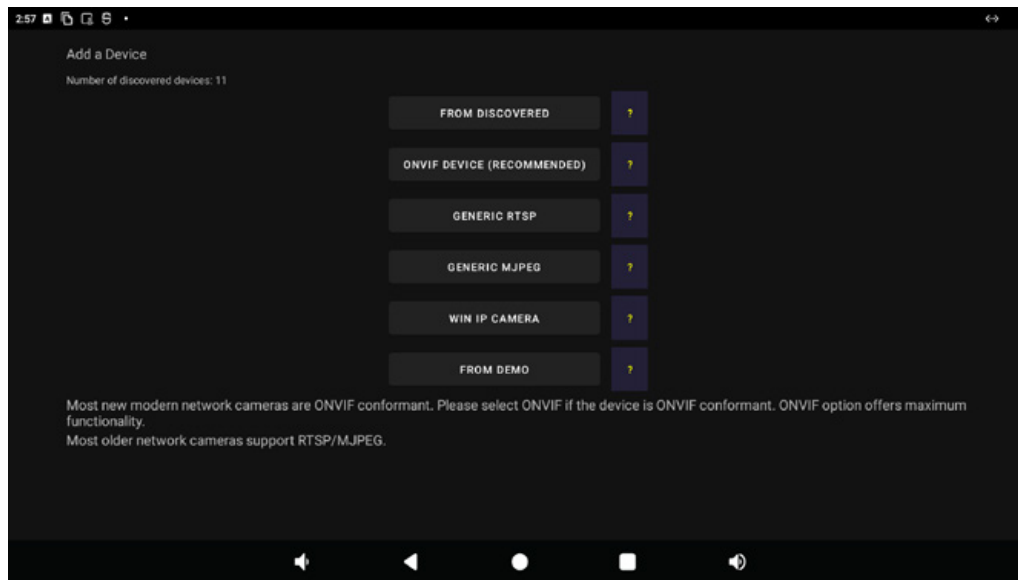

- If user want to add an IP camera, click **+** icon on **ViewZ's ONVIF IP Cam Viewer**. Then, user will see the above screen.
- At this window, user can add IP camera based on its circumstance.
- **FROM DISCOVERED** - All ONVIF and Window IP camera devices on your LAN (network) are discovered automatically.
- **ONVIF DEVICE** (Recommended) - Recommended choice if your device is ONVIF conformant because it has full functionality.
- **GENERIC RTSP** - RTSP streams have both video and audio, but no built-in PTZ control. The **ViewZ's ONVIF IP Cam Viewer** has custom commands that can be used potentially for PTZ.
- **GENERIC MJPEG** - MJPEG has video only. Its advantages are low latency and support by old cameras.
- **WIN IP CAMERA** - WIN IP Camera is a Windows Phone app that turns a Windows Phone into a high end HD IP camera with double-lens, crystal clear two-way audio, battery power, internal/external storage, touch-screen control. This may be the best use of a retired idling old phone increasing its value by 10 folds. You can download this FREE Windows Phone app from Windows Store.
- **FROM DEMO** - Demo cameras from third parties can be added for testing. This demo function needs to access the WAN network.

# CONTROL AND FUNCTION

## Add a Device - FROM DISCOVERED

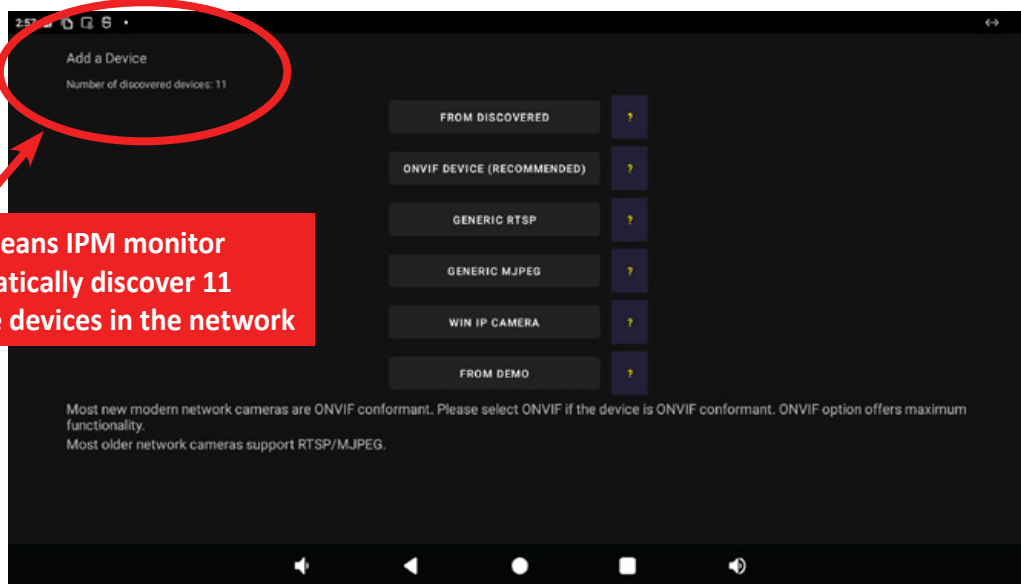

- When user click '**FROM DISCOVERED**', user will see below screen and the green box button can be added on the **ONVIF IP Cam Viewer**. The gray box button (device) means it's already added on **ONVIF IP Cam Viewer**.

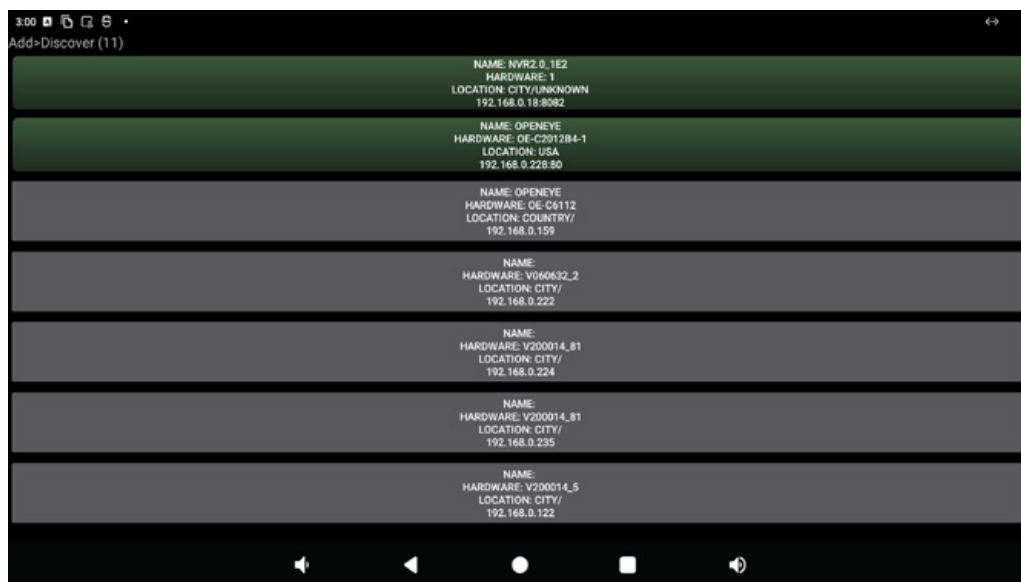

- This function requires **IPM monitor** and **IP cameras** (or ONVIF devices) should be grouped in the same network.
- This function allows user to select a device and easily fill up the address field.

# CONTROL AND FUNCTION

## Add a Device - FROM DISCOVERED

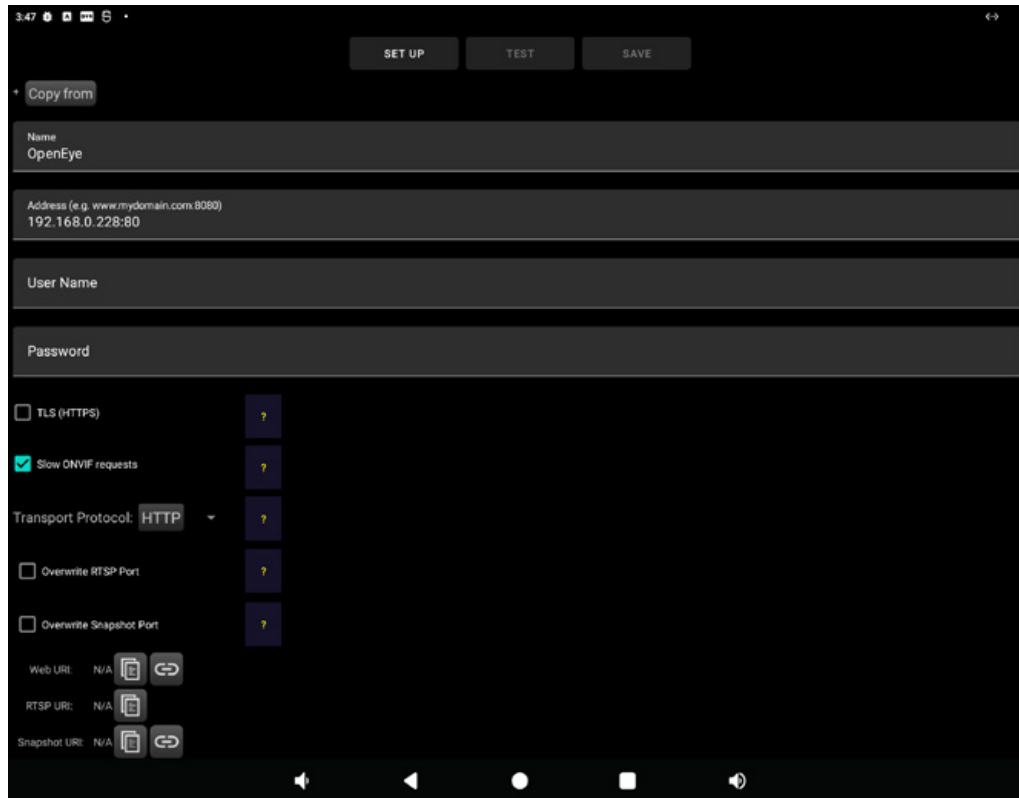

- When user select & click one of listed device, user will see the above screen.
- And user might need to type user name, password and more information depending on your device configuration. But, the '**Address**' will be automatically typed by the system.
- Click "**SET UP**" to configure by retrieving information from the device.
- Click "**TEST (Video)**" to allow **ONVIF IP Cam Viewer** to select the best transport protocol and validate the video streaming.

# CONTROL AND FUNCTION

## Add a Device - ONVIF DEVICE

2:59

SET UP TEST SAVE

+ Copy from

Name

Address (e.g. www.mydomain.com:8080)

User Name

Password

TLS (HTTPS) ?

Slow ONVIF requests ?

Transport Protocol: HTTP ?

Overwrite RTSP Port ?

Overwrite Snapshot Port ?

Web URI: N/A ?

RTSP URI: N/A ?

Snapshot URI: N/A ?

- This function allows user to type the ONVIF device information manually.
- This function is more proper for configuring WAN devices.
- Click "Set Up" to configure by retrieving information from the device.
- Click "Test Video" to allow **ONVIF IP Cam Viewer** to select the best transport protocol and validate the video streaming.

# CONTROL AND FUNCTION

## Add a Device - GENERIC RTSP

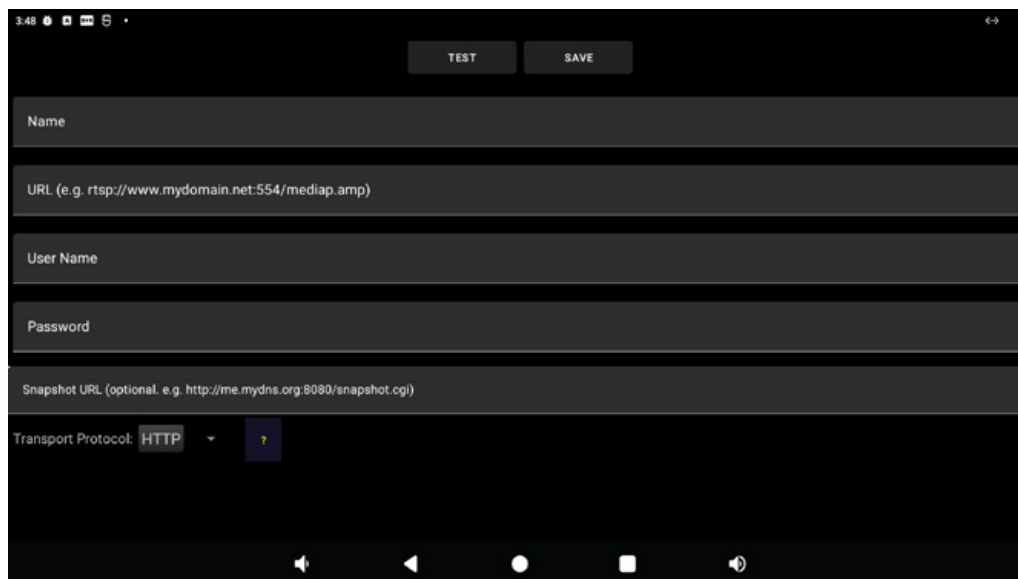

3:48

TEST SAVE

Name

URL (e.g. rtsp://www.mydomain.net:554/medlap.amp)

User Name

Password

Snapshot URL (optional, e.g. http://me.mydns.org:8080/snapshot.cgi)

Transport Protocol: HTTP

- This function is used for streaming an RTSP URL.
- Most non-ONVIF NVTs support.
- RTSP streaming supports both audio and video signal.
- Click "Validate" to allow **ONVIF IP Cam Viewer** to select the best transport protocol and validate the video streaming.

# CONTROL AND FUNCTION

## Add a Device - ONVIF DEVICE

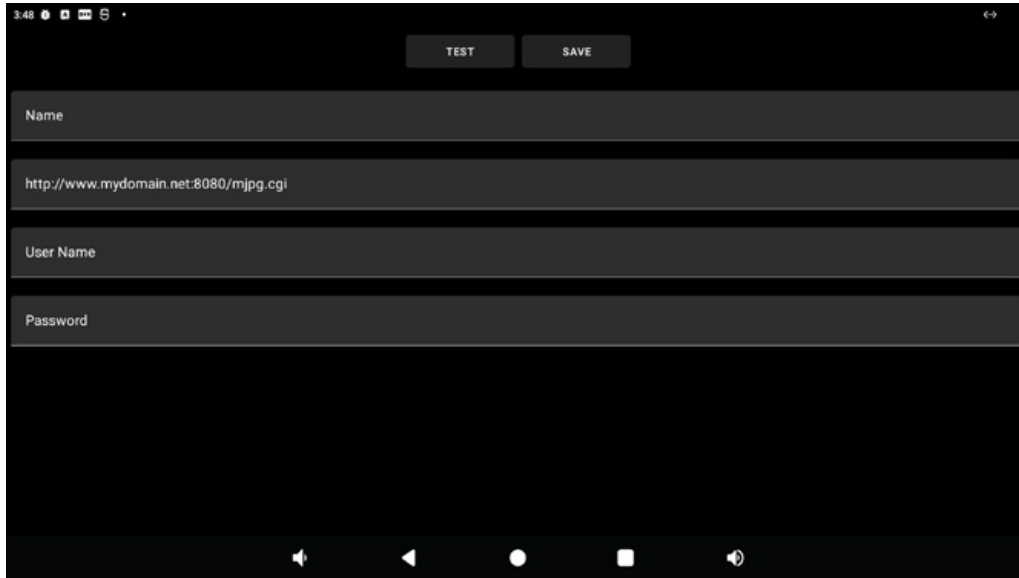

The screenshot shows a mobile application interface for adding an ONVIF device. At the top, there are two buttons: "TEST" and "SAVE". Below these are four input fields:

- Name
- http://www.mydomain.net:8080/mjpg.cgi
- User Name
- Password

The bottom of the screen shows the Android navigation bar with back, home, and recent apps icons.

- This function is using for streaming an MJPEG URL.
- The oldest NVTs support
- MJPEG streaming has video signal only.
- Click "Validate" to allow **ONVIF IP Cam Viewer** to validate the video streaming.

# CONTROL AND FUNCTION

## Sequential View - Launch & Setup

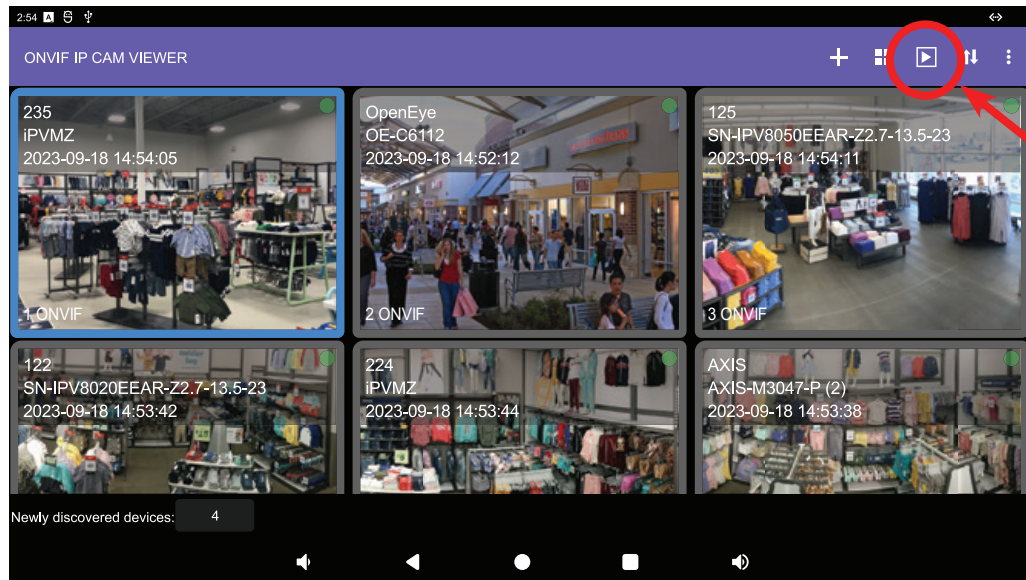

- Click  to start sequential view which show all registered camera streaming based on interval time.

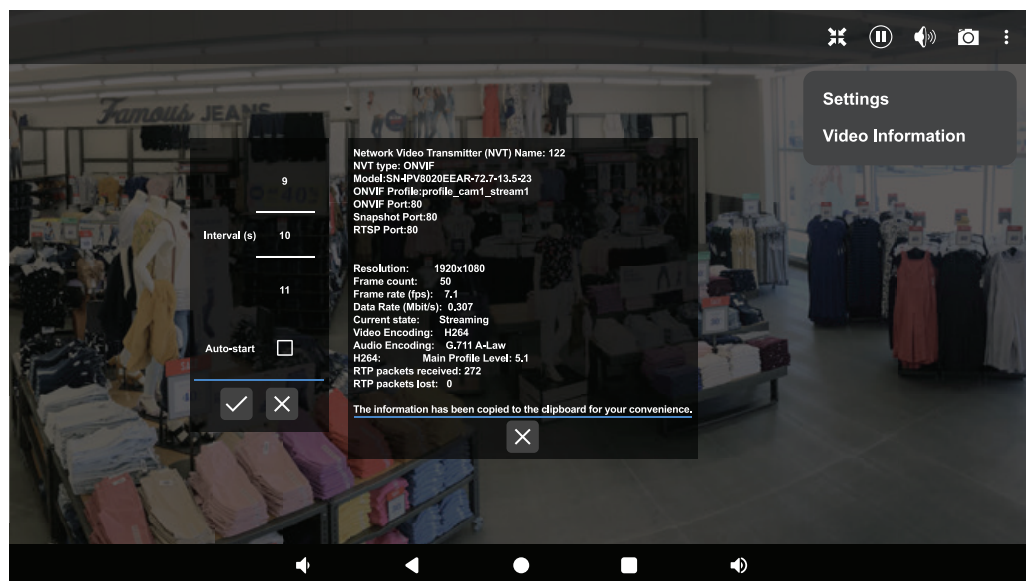





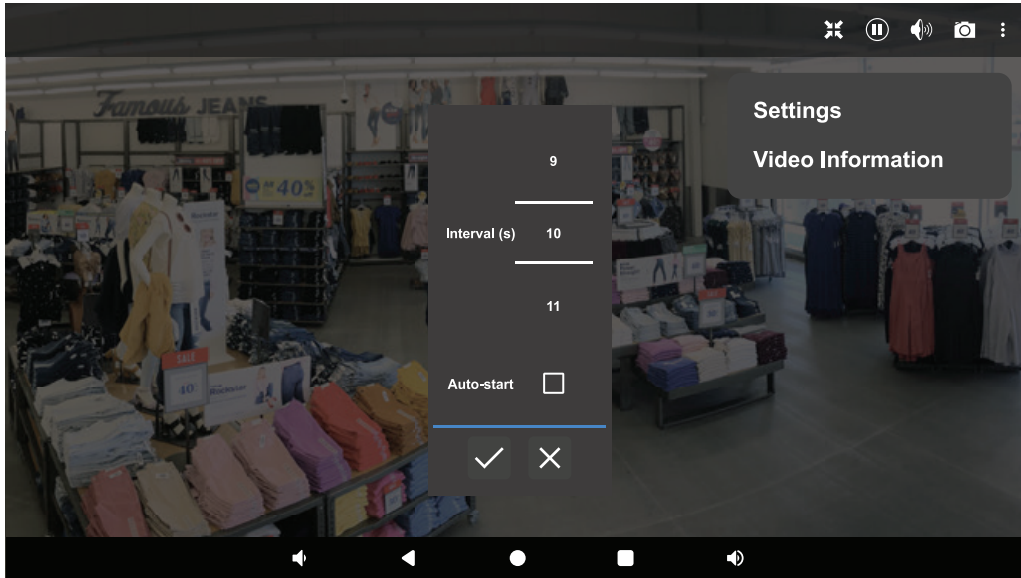

- Click  to set the interval time of sequential view or see the current streaming information.

# CONTROL AND FUNCTION

## Sequential View - Launch & Setup



- Click '**Settings**' to setup the interval time of sequential view. If user check '**Auto-start**', user will see the sequential view when starting **OICV (ONVIF IP Cam Viewer) App**.
- Show the all camera in order. Interval time is set as 10 seconds as a default. User can set the interval time from 5 to 30 sec.
- Click  to set the aspect ratio based on camera.
- Click  to fill up the video on the monitor.
- Click   to play & stop the sequential streaming.
- Click   to on & off the sound.
- Click  to take a snapshot.

# CONTROL AND FUNCTION

## Sequential View - Video Streaming, Recording, Pan/Tilt/Zoom (PTZ)

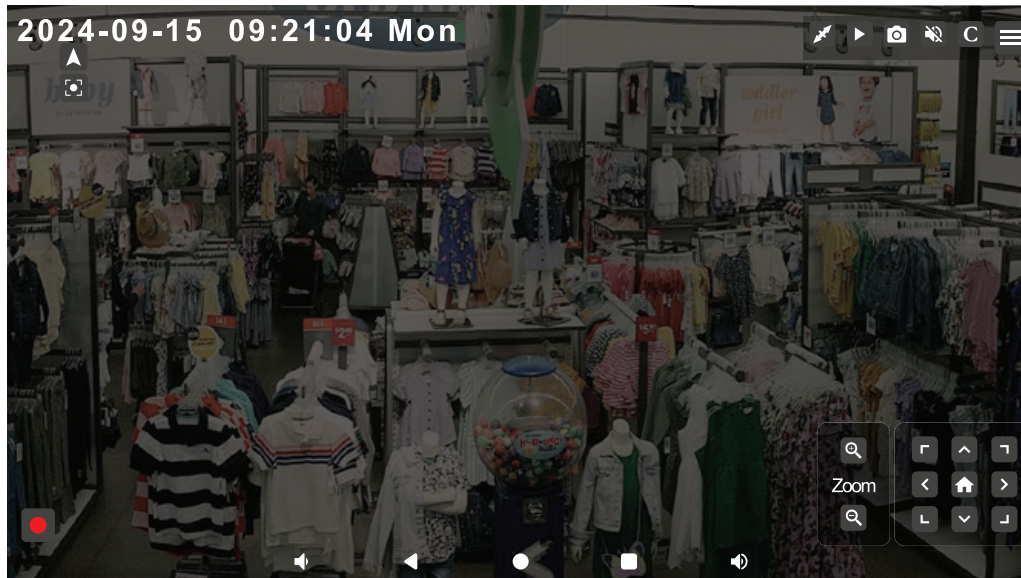

- When user select and see a full screen among device tiles or sequence view, user can take a snapshot, play & stop streaming, setup aspect ration and control the camera.
- Click to stretch the video to fill the window while maintaining the aspect ratio.
- Click to pause the video. Click to resume the video streaming.
- Click to take a snapshot.
- Click to mute the audio (if audio is available).
- Click to turn on the audio.
- Click to show the camera information with command
- Click to show "Video Information" which display a variety of properties of the video stream.
- Click to record a live video.
- Click to set the lens focus. Click to set the lens focus with people. Click to set the lens focus with background.
- Click buttons to control PTZ, if the selected camera support PTZ.

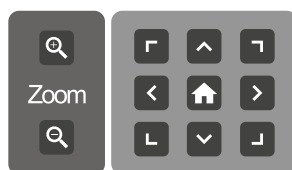



### Note

- The function of full screen view is applied for both sequence view and multiview

# CONTROL AND FUNCTION

## For Devices supporting H.264 encoded video

- Click  to start recording.
- Click  to stop recording. Internal storage is used to store temporary files of the recording.

Free storage space: 23.093 GB  
00:00:01



- An MP4 file is saved in the storage space for movies or any specified storage space, and all temporary files are deleted when the recording finishes.
- You will be asked whether to play the recorded video.

A new video file has been save. 12.9 MB

PLAY VIDEO

- Some Android devices may not be able to play the recorded video.
- The video file will be saved under "IPM's internal memory Settings/Files/Pictures/XXXX" ('XXXX' will be named as camera name) can be downloaded for playing on other devices such as desktop computers.

## For PTZ devices (devices supporting opto-mechanical PTZ)

- Flick (i.e. swipe, fling or drag) on the touchscreen to pan/tilt.
- You can also tap the arrows to pan/tilt.
- Pinch to zoom. You can also click button "+" to zoom in, click button "-" to zoom out.

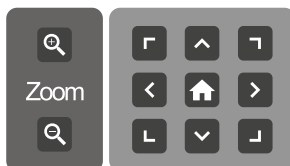

# CONTROL AND FUNCTION

## Multiview - Setup

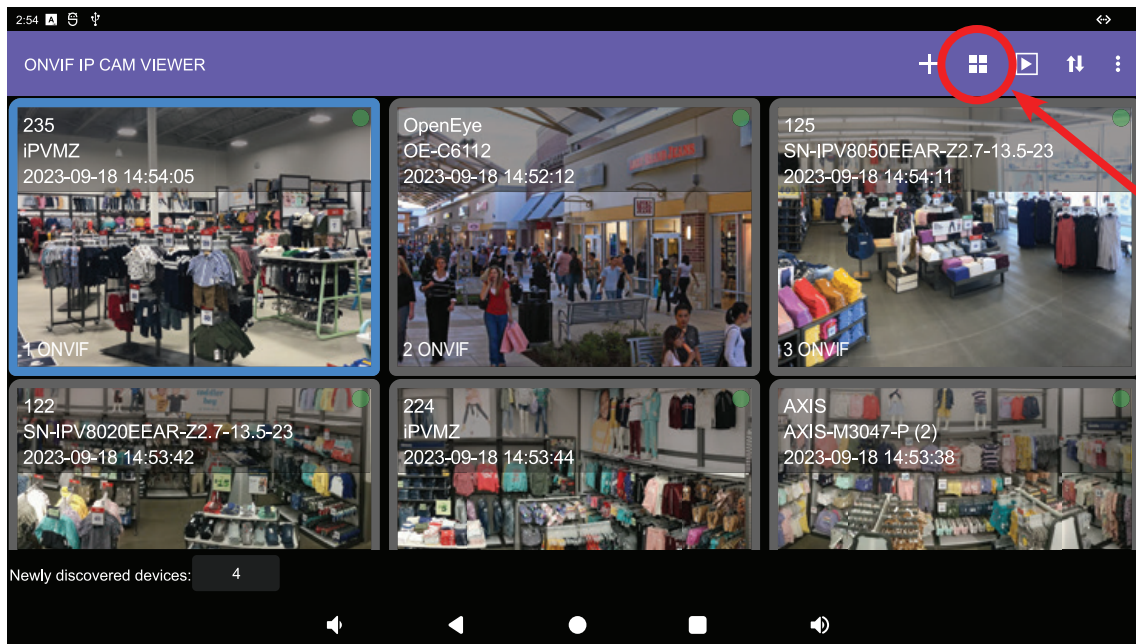

- Click  to start multiview viewing mode which show all registered cameras or devices by grid.
- User can set multiview screens as **1 / 2 / 3 / 4 / 6 / 9 / 12 / 16** channel.
- When user access the multiview viewing mode at the first time, user should set up a multiview mode.

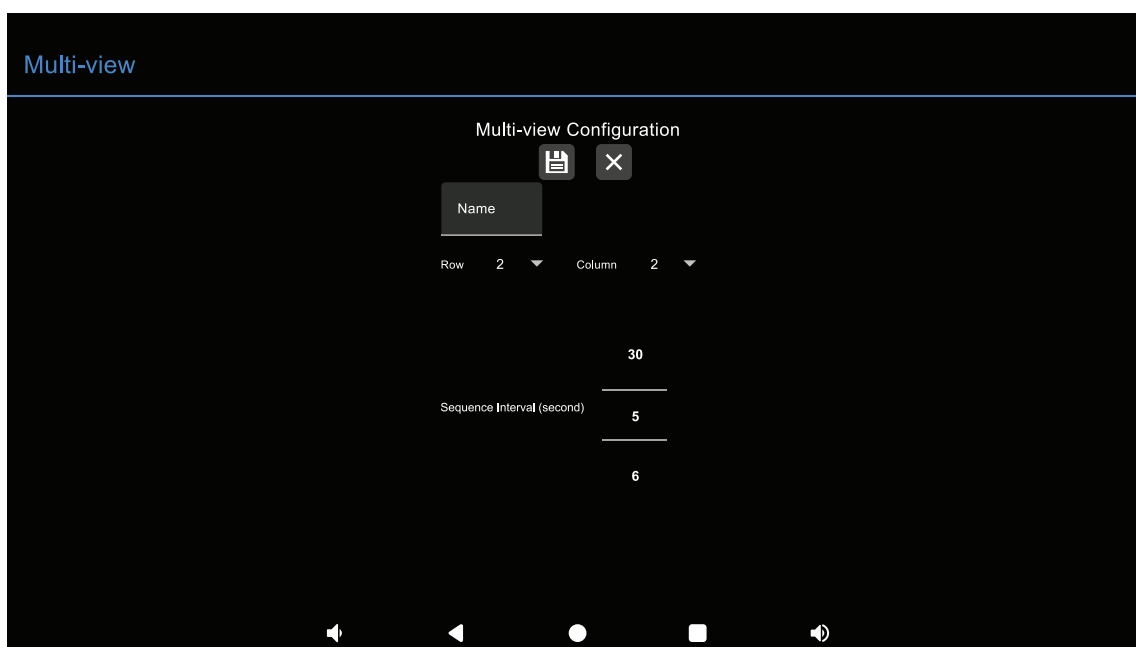

# CONTROL AND FUNCTION

## Multiview - Setup

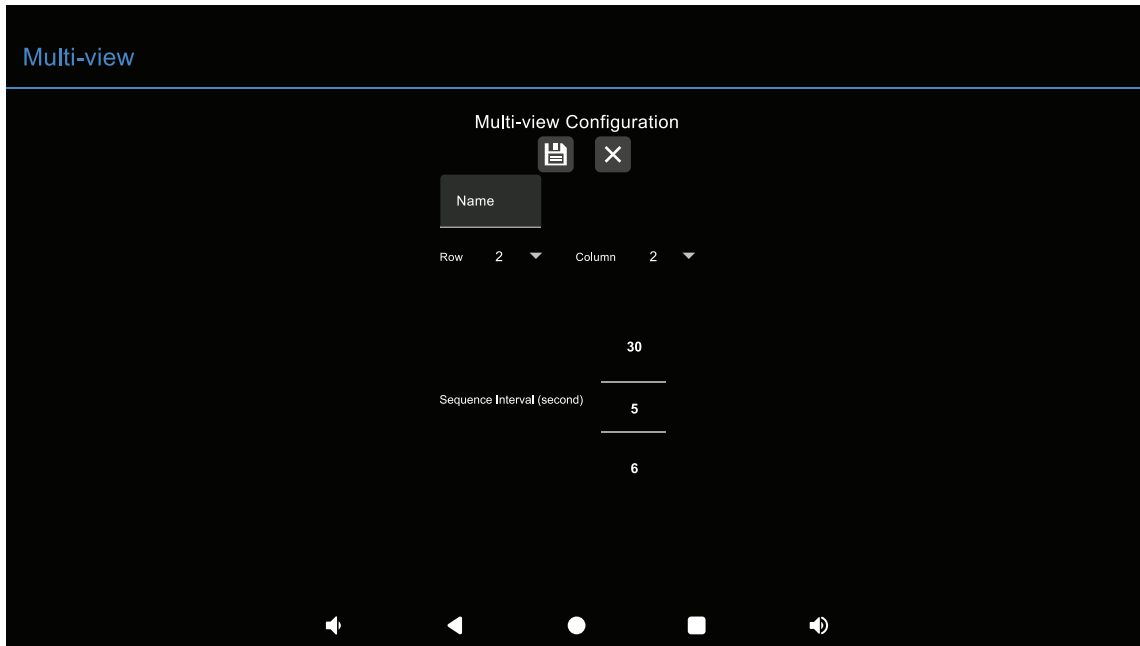

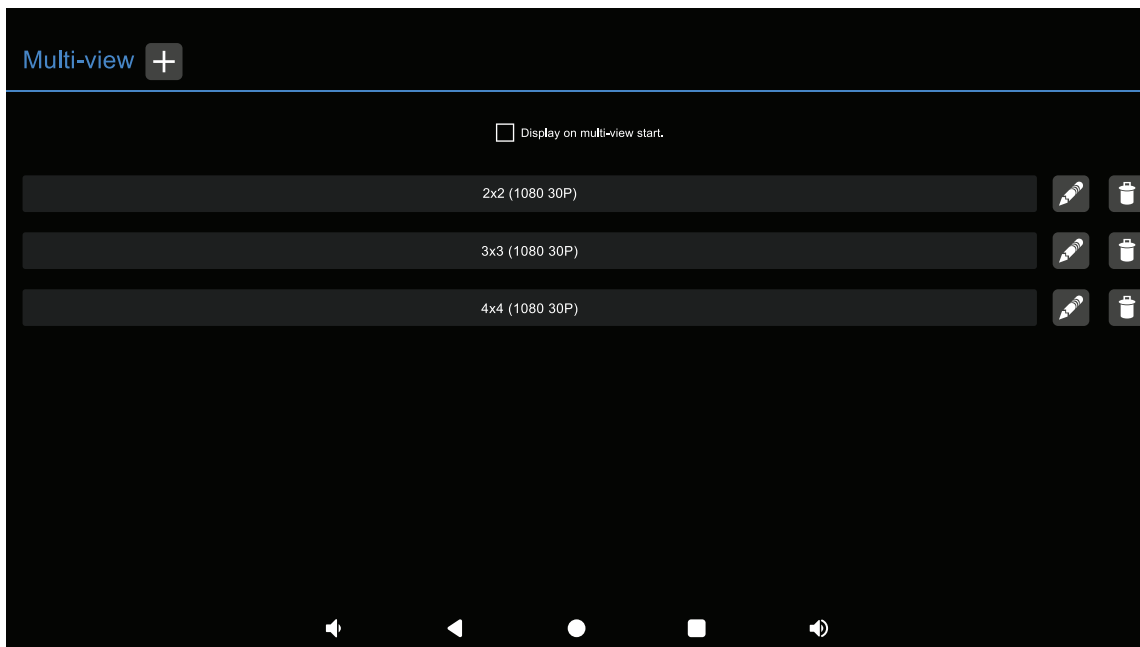

- Name - multiview mode name
- Row - a number of row. Max. number is '4'.
- Column - a number of column. Max. number is '4'.
- Sequence Interval - setup the sequential time between 5 and 30 sec. When user switch the sequential viewing mode from multiview viewing mode, the interval time of sequential viewing mode is done by this 'Sequence Interval'.
- User can also add several multiview viewing modes.

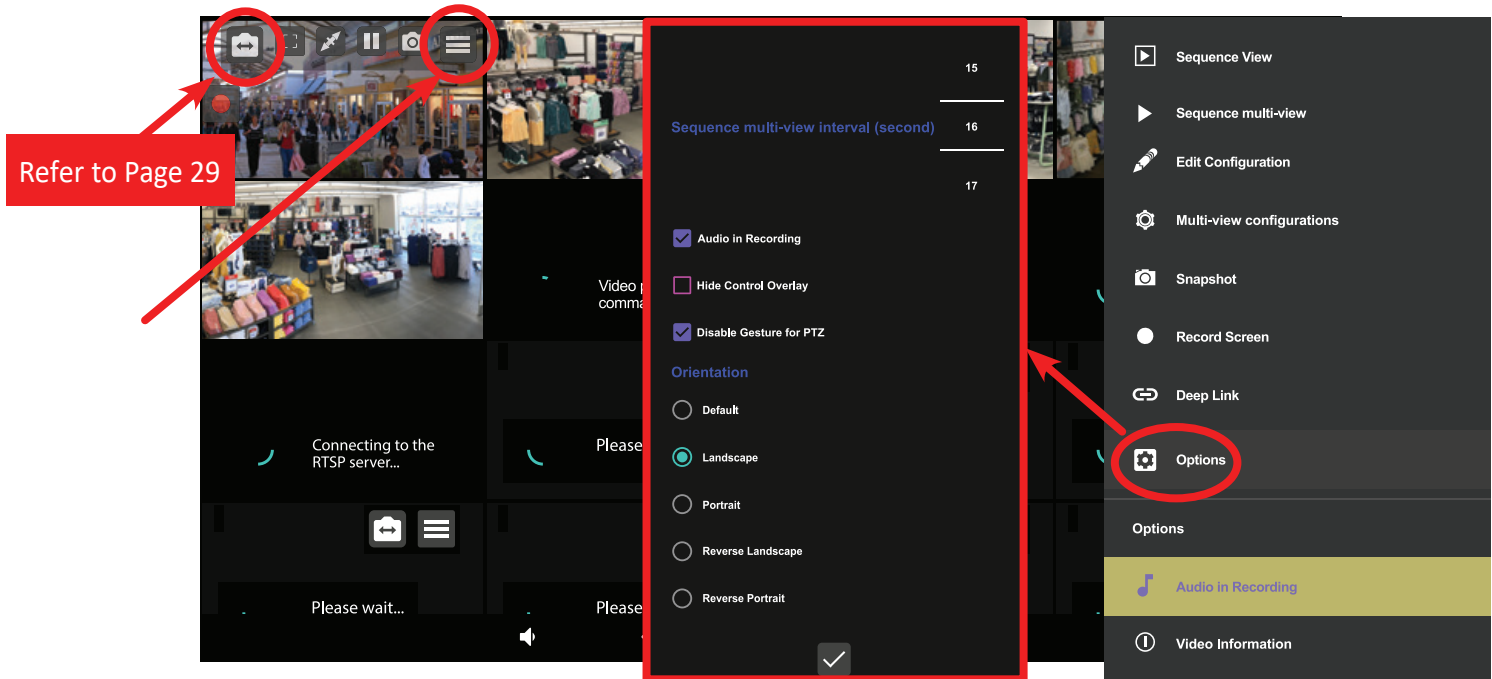

# CONTROL AND FUNCTION

## Multiview - Setup



- Click  to set up the detailed features
- **Sequence View** - switch the viewing mode from multiview to sequence view
- **Sequence multi-view** - switch the viewing mode from multiview to sequence multi-view
- **Edit Configuration** - edit the current multiview mode
- **Multi-view configurations** - see all multiview mode (refer to page 26)
- **Snapshot** - take each snapshot of multiview screens at a time
- **Record Screen** - record the entire multiview screen as one screen
- **Deep Link** - not support
- **Options** - setup the **Sequence multi-view interval** (between 15 and 300 seconds), **Audio in Recording**, **Hide Control Overlay**, **Disable Gesture for PTZ** and **Orientation** (Default, Landscape, Portrait, Reverse Landscape, Reverse Portrait)
- **Audio in Recording** - turn on / off audio in recording video
- **Video Information** - display each device streaming information
- **Hide Control Overlay** - hide the camera control OSD on all multiview screen
- **Disable Gesture for PTZ** - block the PTZ control
- **Debugging Log** - using for developer



### Note



- The detailed feature of multiview & sequence view is same.
- The sequence multi-view is running by the order of multi-view list (refer to page 27). For example, if user setup 3 multi-view viewing modes, user will sequentially see these 3 multi-view modes.

# CONTROL AND FUNCTION

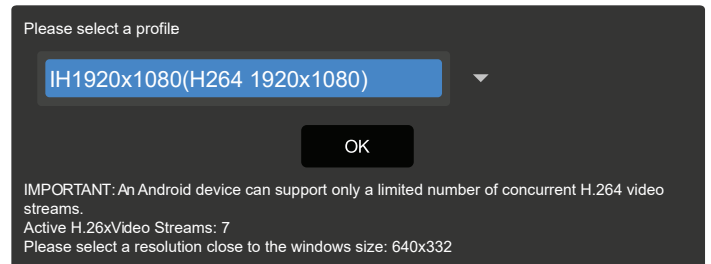
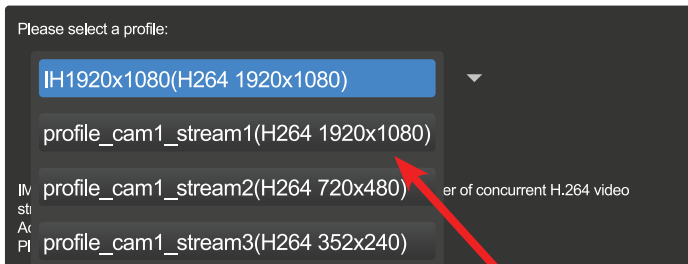
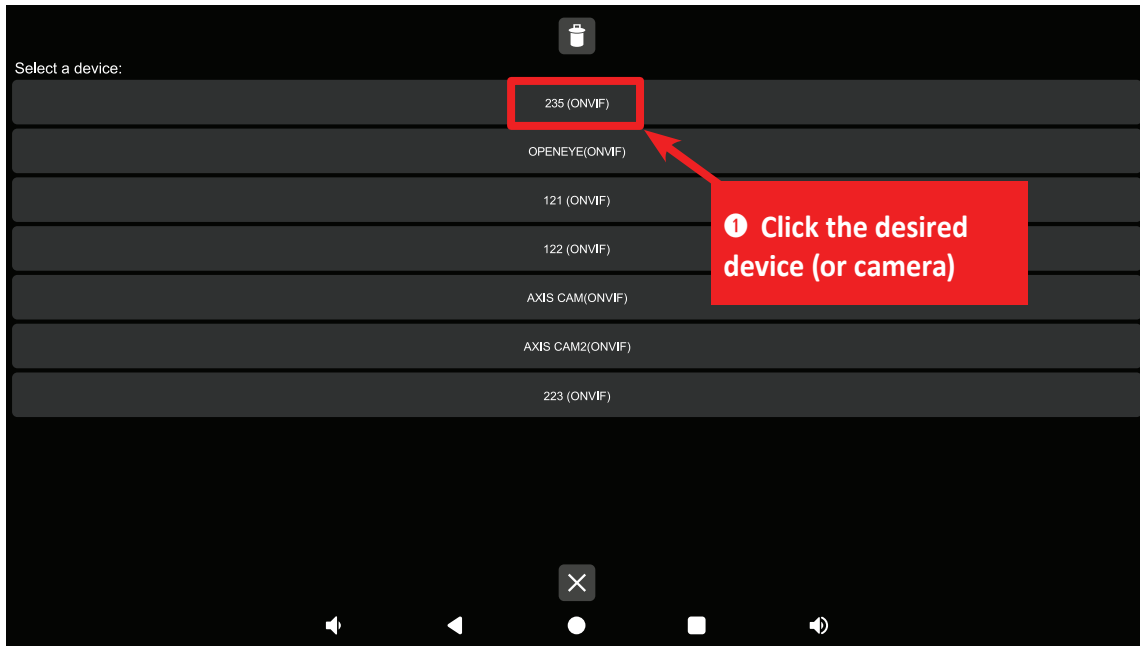
## Multiview - Add or Switch the Device Display









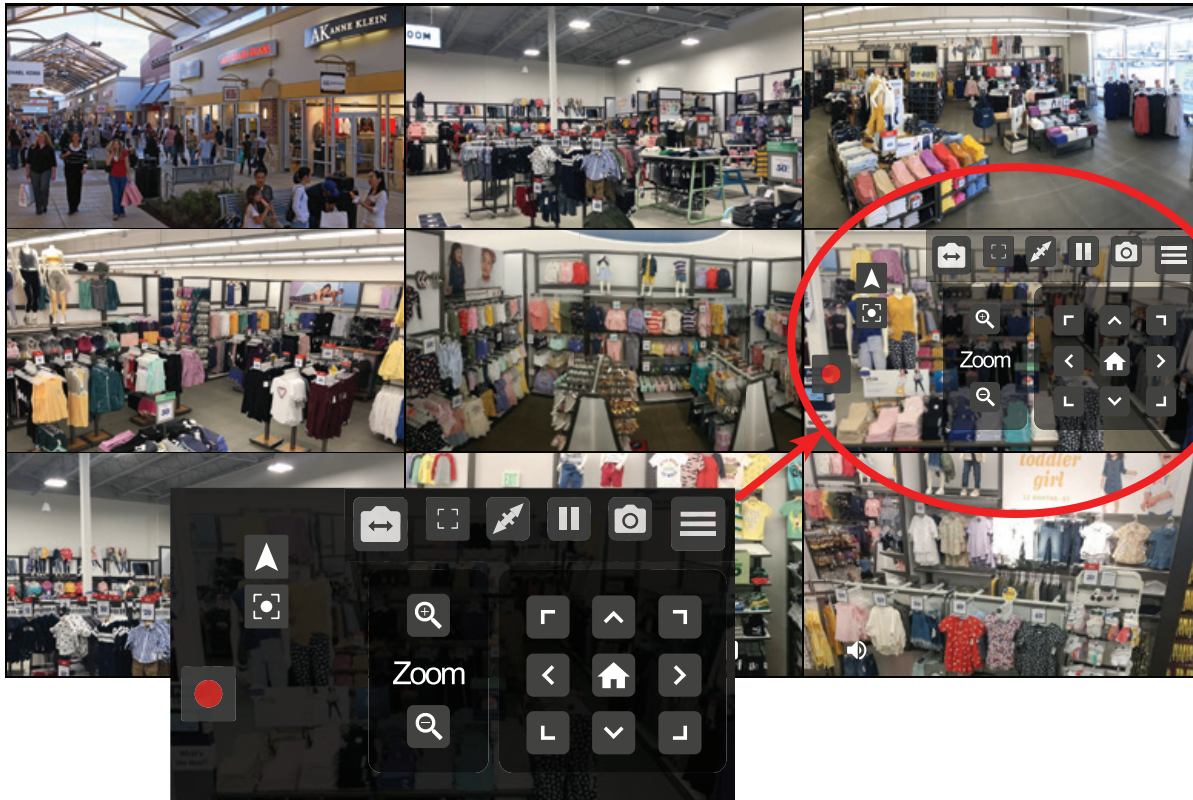

2 Click the desired profile

- If user click  button, user can add the device or switch the current device display.
- Click  to see the above screen which show registered devices or cameras.
- If user click one of devices, then user can choose the streaming resolution. **OICV (ONVIF IP Cam Viewer)** App supports 1080p resolution on each screen of 16x16 channel viewing mode.
- Select the profile and click 'OK' to apply it.

# CONTROL AND FUNCTION



## Multiview - Control A Device (Camera)



- Click  to add or switch a device (camera)
- Click  to display full screen (selected screen)
- Click  to stretch the video to fill the window while maintaining the aspect ratio.
- Click  to pause the video. Click  to resume the video streaming.
- Click  to take a snapshot.
- Click  to set up the detailed features
- Click  to record a live video.

Select "Record Screen" to start recording the screen. The information bar will let user to stop or keep recording a live stream as necessary. By using the back button (or right click of mouse) to stop the recording.

Please note that the audio recording should be supported by streaming device (or camera).

- Click  to set the lens focus. Click  to set the lens focus with people. Click  to set the lens focus with background.
- Click buttons to control PTZ, if the selected camera support PTZ.



# CONTROL AND FUNCTION

## More Options

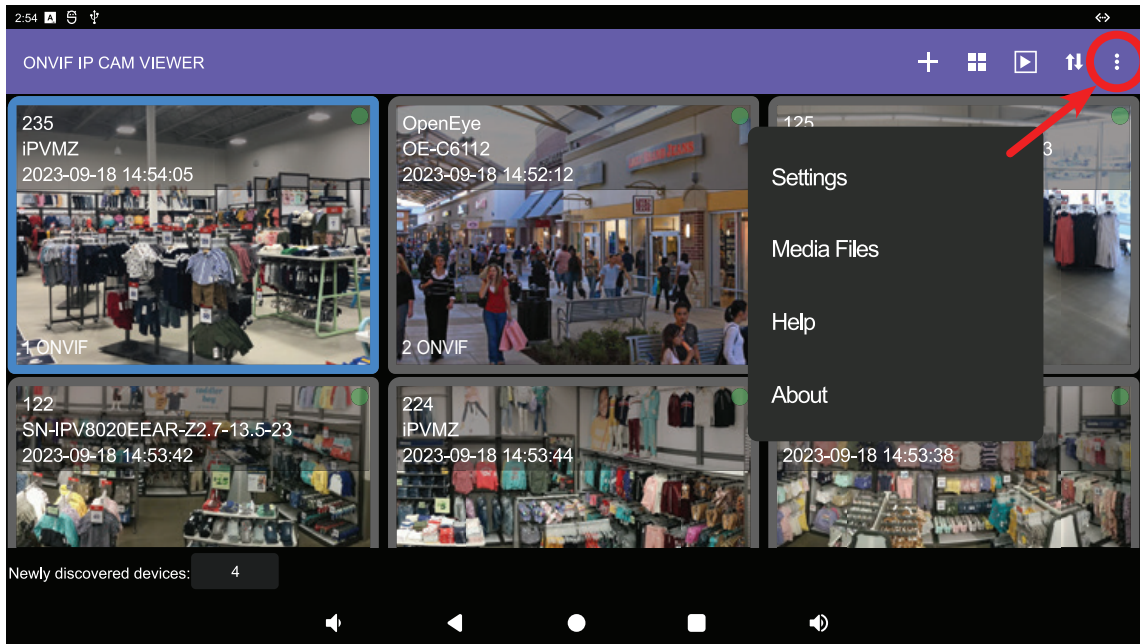

- Click  to access more options.
- **Settings** - export & import saved device (camera) information, setup the saving location of media file and etc
- **Media Files** - See the saved screenshots, recorded video files and other files
- **Help** - Open the **ViewZ's ONVIF IP Cam Viewer** user manual
- **About** - Display **ViewZ's ONVIF IP Cam Viewer** version info

# CONTROL AND FUNCTION

## More Options - Settings

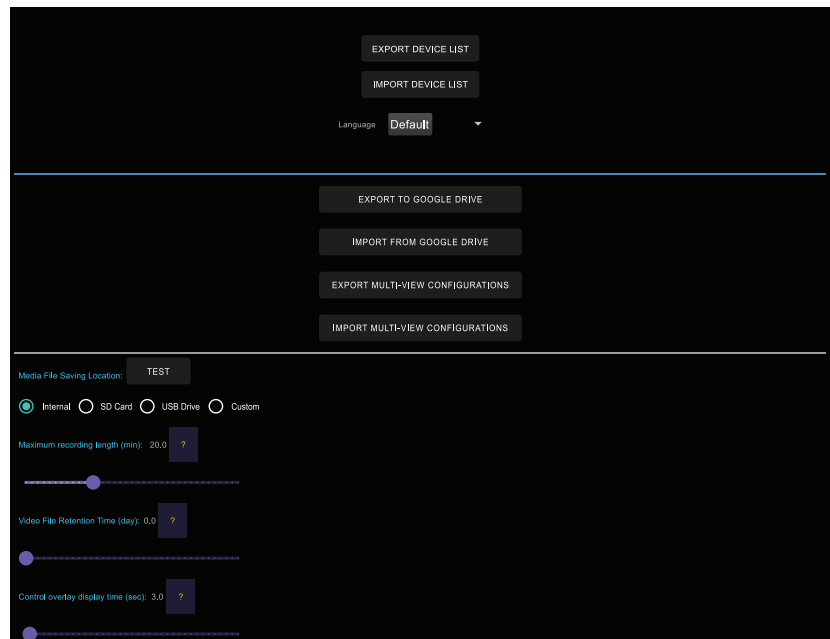
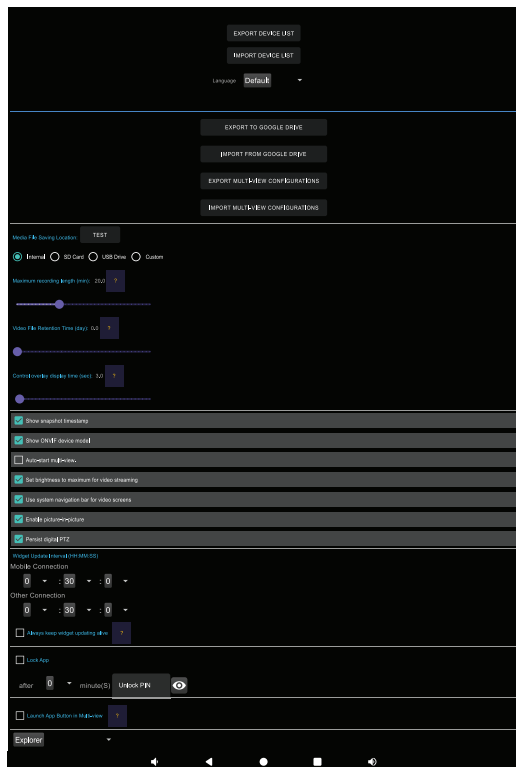

Click "More Options/Settings" to open the settings screen:

- **EXPORT DEVICE LIST** - export the configured device list to a file and share the list via some other installed apps such as Google Drive, Email
- **IMPORT DEVICE LIST** - import an exported device list from a file
- **Language** - setup the display language. The default language is English
- **EXPORT TO GOOGLE DRIVE** - export the configured device list to Google drive
- **IMPORT FROM GOOGLE DRIVE** - import an exported device list from Google drive
- **EXPORT MULTI-VIEW CONFIGURATION** - export the configured multi-view information to a file
- **IMPORT MULTI-VIEW CONFIGURATION** - import the configured multi-view information from a file
- **Media File Saving Location** - select the saving location among internal storage space, external SD card or USB drive (snapshots, video recording)

Click 'TEST' button to create a test file in the specified location

Maximum recording length (min) - recording video stops at the maximum recording time (0 ~ 60 minutes)

Video File Retention Time (day) - video files older than the retention time are deleted. Value 0 means no deletion (0 ~ 60 days)

Control Overlay Display Time (sec) - setup the OSD display time (0 ~ 60 seconds)

# CONTROL AND FUNCTION

## More Options - Settings

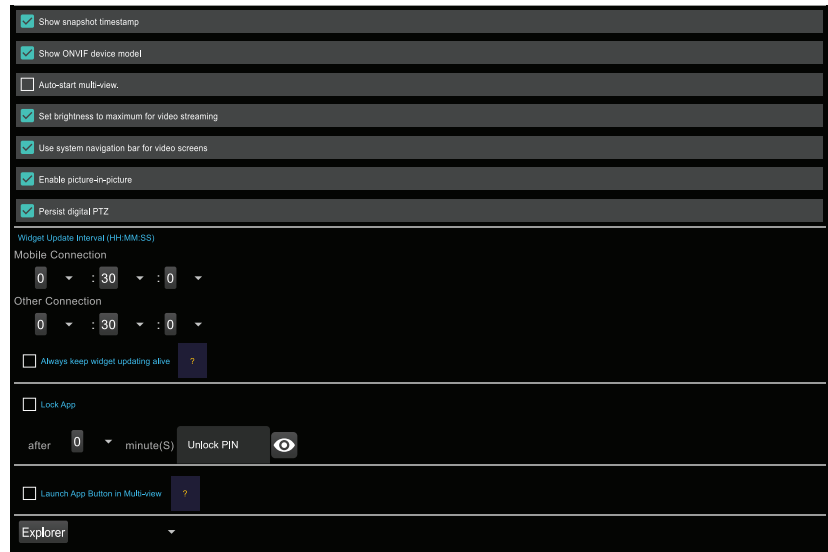
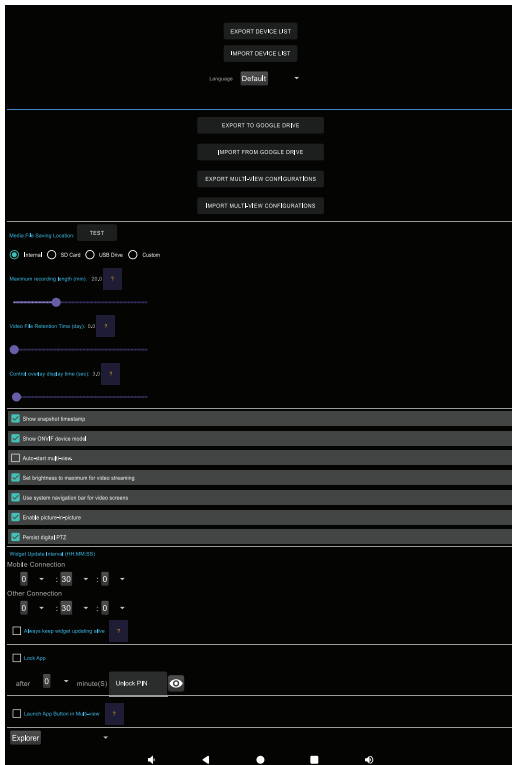

- **Show Snapshot Timestamp** - show or hide background snapshot timestamps on the device (camera) screen
- **Show ONVIF** - show or hide ONVIF device models on the multiview screen
- **Auto-start Multi-View** - when user enable this option, **ONVIF IP Cam Viewer** App will automatically show multiview screen on launching App
- **Set Brightness to Maximum for Video Streaming** - setup the maximum brightness during device (camera) streaming
- **Use System Navigation Bar for Video Screens** - show or hide system navigation bar on device (camera) screen
- **Enable Picture-In-Picture** - enable or disable about picture-in-picture mode
- **Persist Digital PTZ** - enable or disable about PTZ control
- **Widget Update Interval** - specify the widget background snapshot updating interval for mobile connection or other types of network connections
- **Lock App** - setup the automatic lockdown time of **ONVIF IP Cam Viewer** App if there are no actions
- **Launch App Button in Multi-view** - when user enable this option, **ONVIF IP Cam Viewer** App will automatically show multiview screen on launching App

# CONTROL & FUNCTION/BOSCH CAMERA

## Launch Onvif IP Cam Viewer

- ViewZ's ONVIF IP Cam Viewer App supports variable cameras and it can use the feature of Bosch FLEXIDOME Panoramic 5100i IPC (Hardware ID: NDS-5704-F360) camera.
- The page, from 36 to 49, will describe about how to setup the IPM for Bosch FLEXIDOME Panoramic 5100i IPC camera.



- Click  on the desktop, you will see ViewZ's ONVIF IP Cam Viewer App. The App will be looks like below;

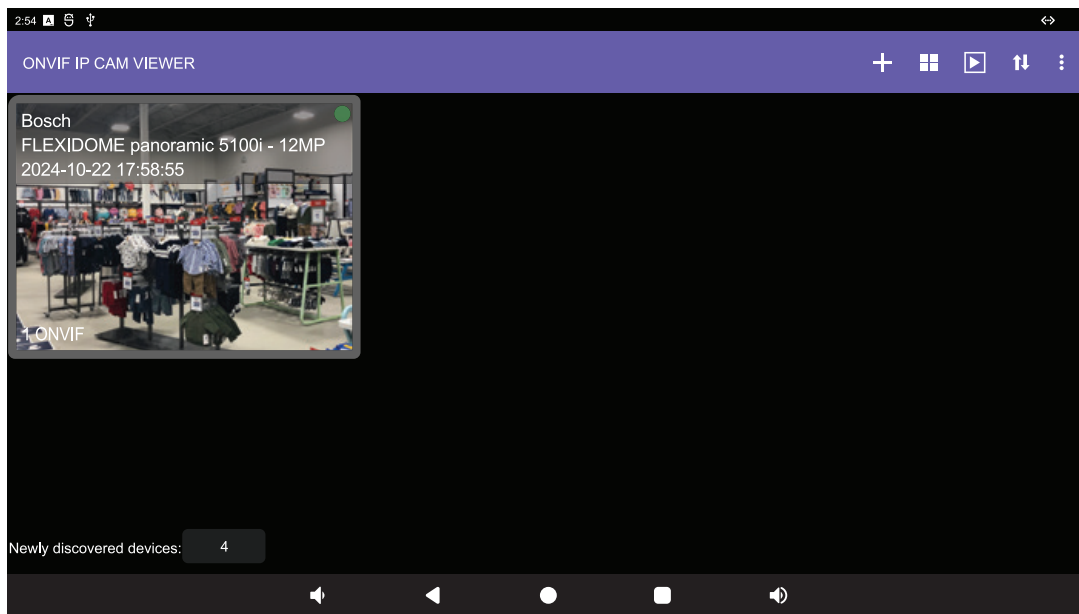



### Note

- This feature is available on the specific IPM monitors which have the serial number of xxxxIBMxxxx / xxxxIGMxxxx.
- If customer want to use this feature with old IPM monitors (the serial number of xxxx INM/IOM/IUM xxxx), customer need to update the ViewZ's App. In this case, please contact to ViewZ Tech Support Team (via phone 714-996-1177 or email [techsupport@viewzusa.com](mailto:techsupport@viewzusa.com)).

# CONTROL & FUNCTION/BOSCH CAMERA

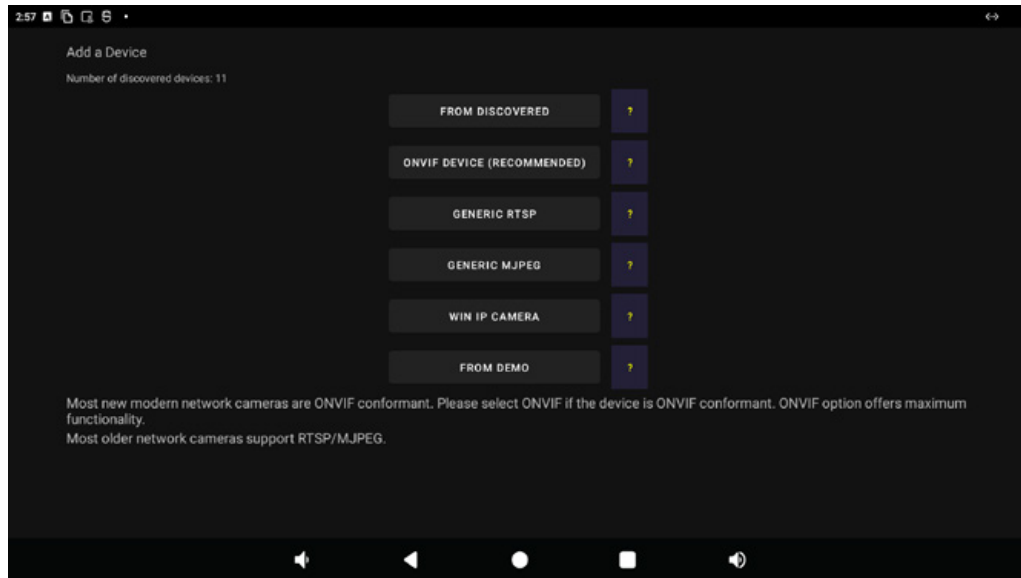
## Add a Device



- If user want to add an IP camera, click  icon on **ViewZ's ONVIF IP Cam Viewer**. Then, user will see the above screen.
- At this window, user can add IP camera based on its circumstance.
- **FROM DISCOVERED** - All ONVIF and Windows IP camera devices on your LAN (network) are discovered automatically.
- **ONVIF DEVICE (Recommended)** - Recommended choice if your device is ONVIF conformant because it has full functionality.
- **GENERIC RTSP** - RTSP streams have both video and audio, but no built-in PTZ control. The **ViewZ's ONVIF IP Cam Viewer** has custom commands that can be used potentially for PTZ.
- **GENERIC MJPEG** - MJPEG has video only. Its advantages are low latency and support by old cameras.
- **WIN IP CAMERA** - WIN IP Camera is a Windows Phone app that turns a Windows Phone into a high end HD IP camera with double-lens, crystal clear two-way audio, battery power, internal/external storage, touch-screen control. This may be the best use of a retired idling old phone increasing its value by 10 folds. You can download this FREE Windows Phone app from Windows Store.
- **FROM DEMO** - Demo cameras from third parties can be added for testing. This demo function needs to access the WAN network.

### Note

- ViewZ recommend to use '**FROM DISCOVERED**'

# CONTROL & FUNCTION/BOSCH CAMERA

## Add a Device - FROM DISCOVERED

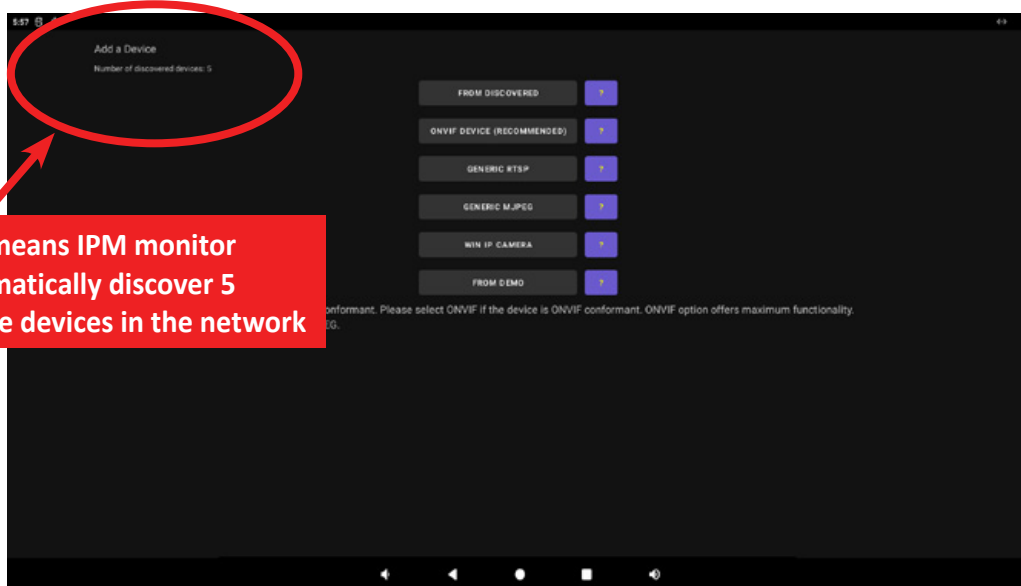

This means IPM monitor automatically discover 5 connectable devices in the network

- When user click '**FROM DISCOVERED**', user will see below screen and the green box button can be added on the **ONVIF IP Cam Viewer**. The gray box button (device) means it's already added on **ONVIF IP Cam Viewer**.

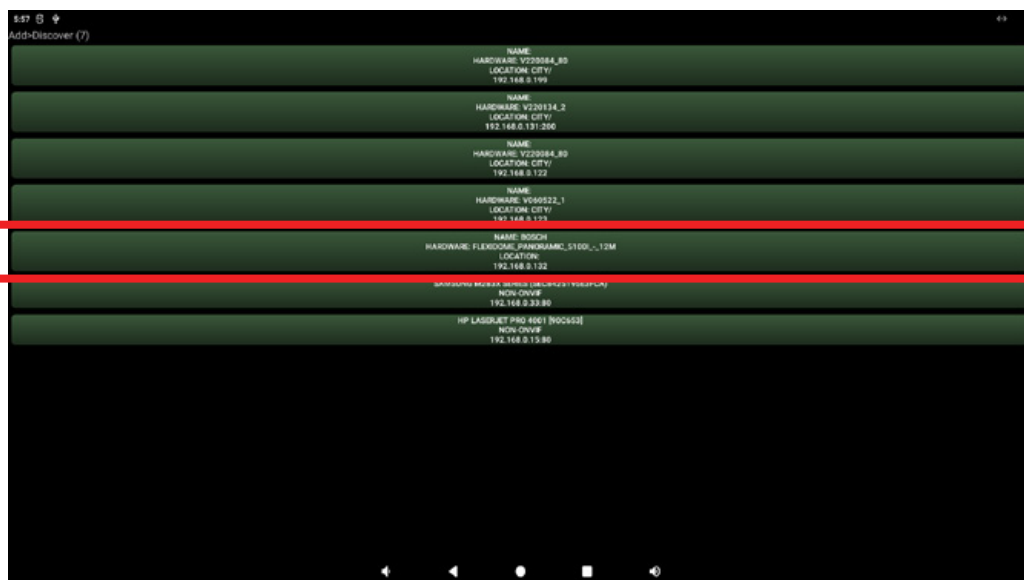

- This function requires **IPM monitor** and **IP cameras** (or ONVIF devices) should be grouped in the same network.
- This function allows user to select a device and easily fill up the address field.
- On the above picture, user can see 'Name: Bosch, Hardware: Flexidome panoramic S5100i ...'. Select this camera to add on IPM monitor

# CONTROL & FUNCTION/BOSCH CAMERA

## Add a Device - FROM DISCOVERED

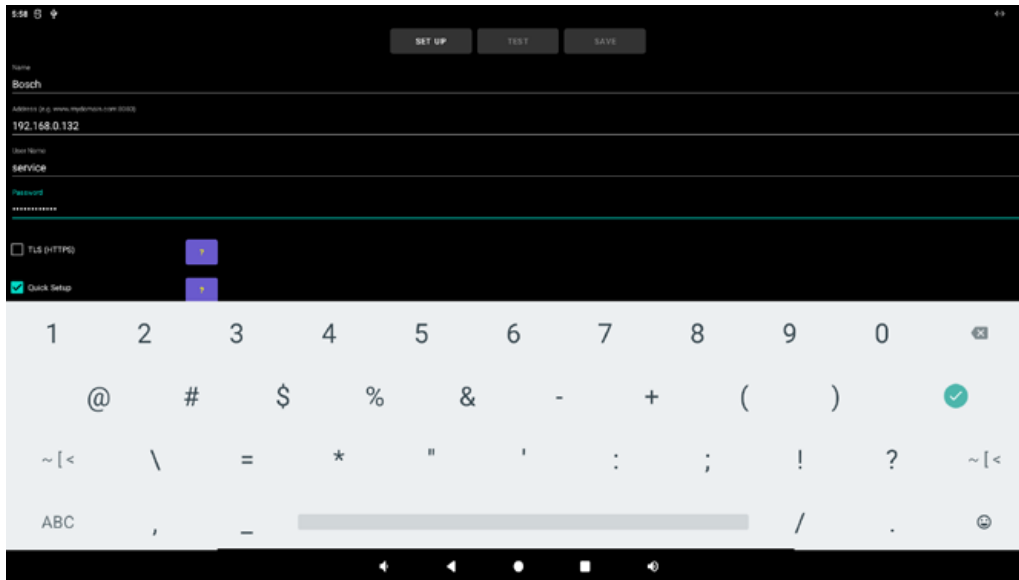

- When user select & click one of listed device, user will see the above screen.
- User needs to type user name, password and more information depending on your device configuration. But, the 'Address' will be automatically typed by the system.
- Click "**SET UP**" to configure by retrieving information from the device.
- Click "**TEST (Video)**" to allow **ONVIF IP Cam Viewer** to select the best transport protocol and validate the video streaming.



### Note

- Please refer other methods (Onvif device, generic rtsp, generic mjpeg & win IP camera) on the page 21.

# CONTROL & FUNCTION/BOSCH CAMERA

## Add a Device - FROM DISCOVERED

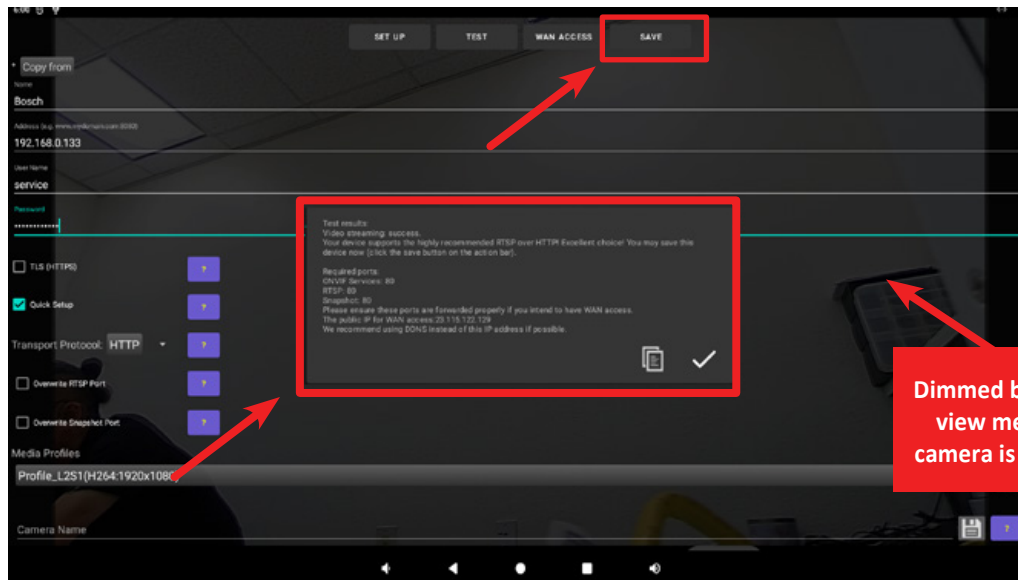

- If the IPM monitor has a successful connection, you will see the above popup window and dimmed camera view.

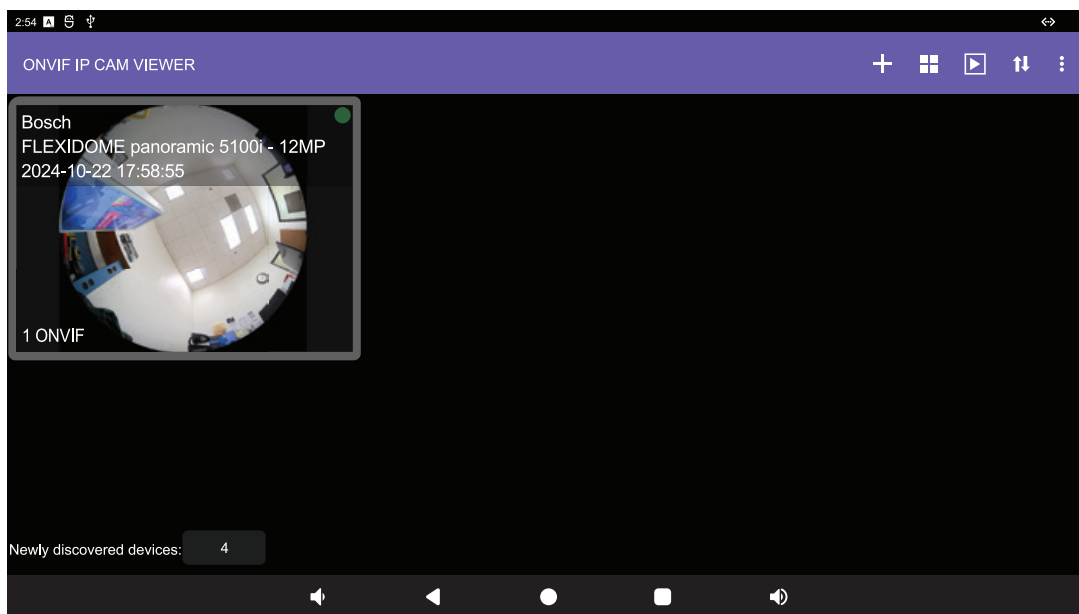

- Go back to the default view of IPM monitor and then user can see the Bosch camera was added on the system.

# CONTROL & FUNCTION/BOSCH CAMERA

## Add a Device - FROM DISCOVERED

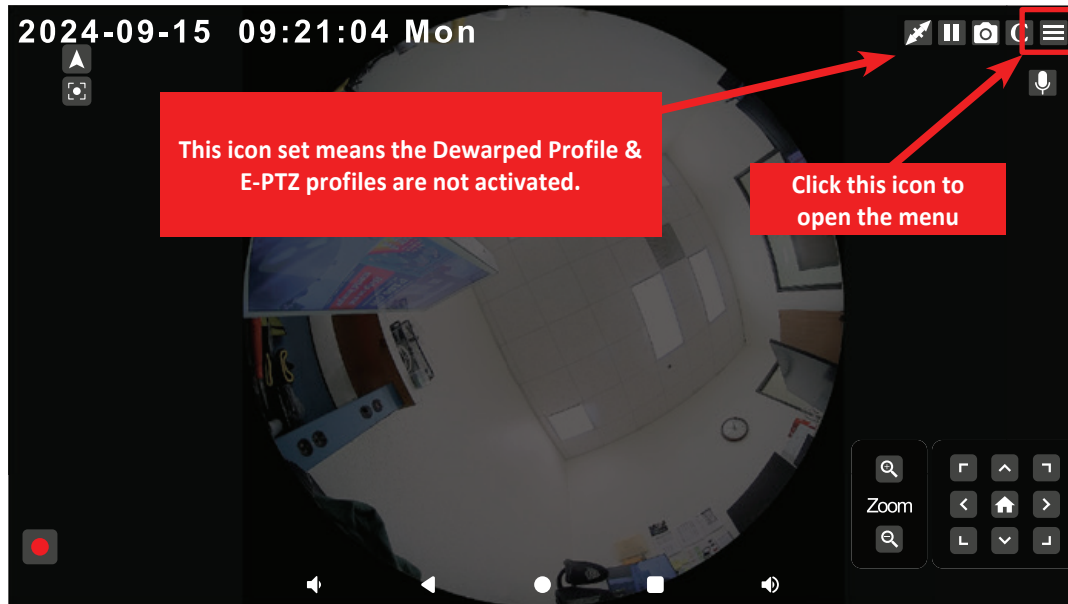

- If user click the window of camera on default view, the single view mode will be displayed, when user did not select Dewarped View or E-PTZ profile during adding camera. On the single view mode, the static camera view will be displayed based on normal profile.
- On the single view, user can select the mode among **Full Image Circle**, **Dewarped View** and **E-PTZ**.



### Note

- When a **Flexidome panoramic S5100i camera** is added, 12 profiles are automatically added.
- User can also select the profile during adding this **Flexidome panoramic S5100i camera**.

# CONTROL & FUNCTION/BOSCH CAMERA

## Profile Selection - Pre-position Setup

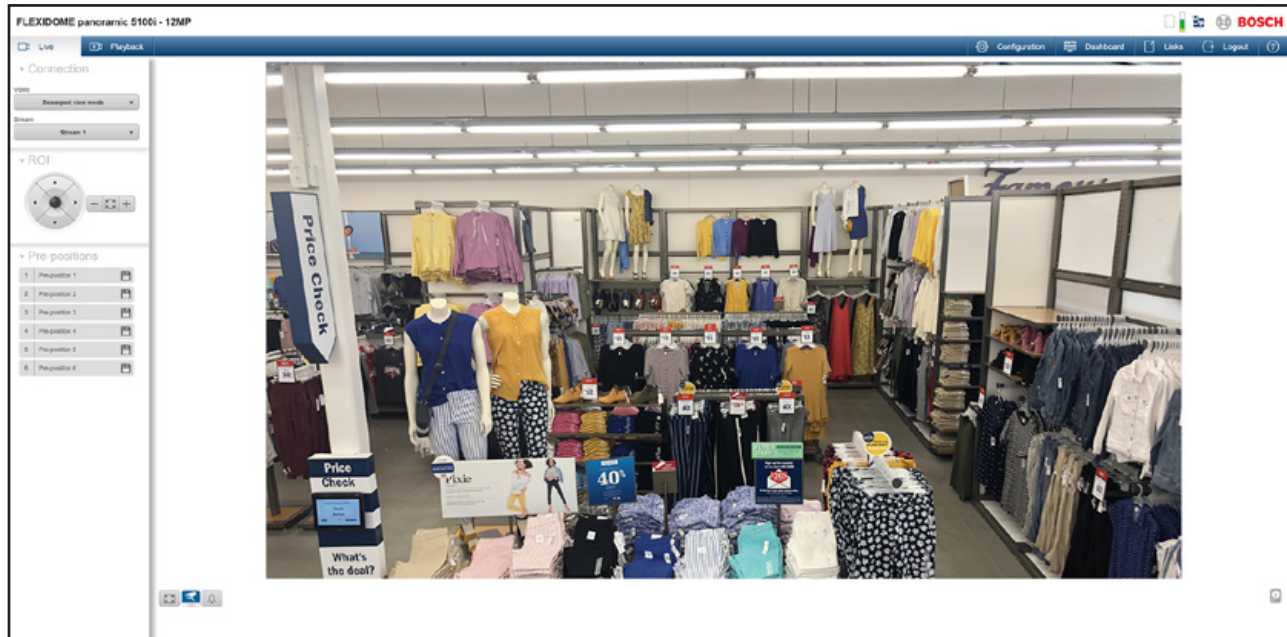

### Note

- To select or use **Dewarped View & E-PTZ** profile on **ViewZ IPM monitor**, user needs to access the **Flexidome panoramic S5100i camera's** control web browser and setup each 6 pre-positions of Dewarped View & E-PTZ.
- If user did not setup the pre-position on the **Flexidome panoramic S5100i camera**, user cannot use the sequential streaming of **Dewarped View & E-PTZ** on **ViewZ IPM monitor**

# CONTROL & FUNCTION/BOSCH CAMERA

## Single View - Profile Selection

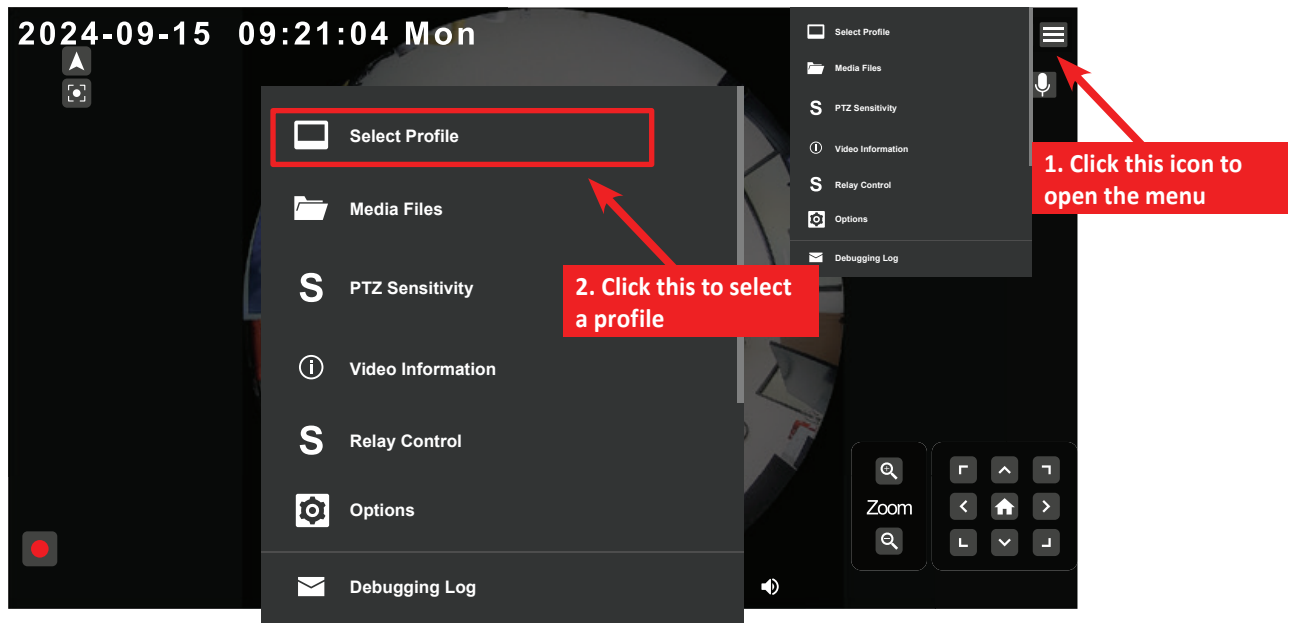

- Click the **MENU** icon and **SELECT PROFILE**

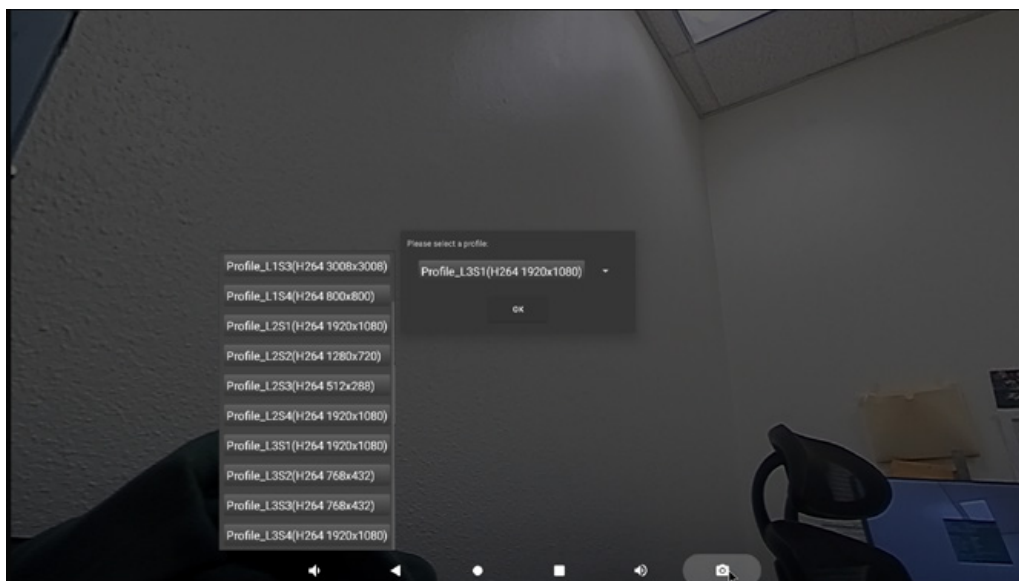

- User will see the list of profile and total profile number is 12.  
 Profile\_L1S1 ~ Profile\_L1S4 : Full Image Circle View profile  
 Profile\_L2S1 ~ Profile\_L2S4 : Dewarped View profile  
 Profile\_L3S1 ~ Profile\_L3S4 : E-PTZ profile

# CONTROL & FUNCTION/BOSCH CAMERA

## Single View - Dewarped View Profile

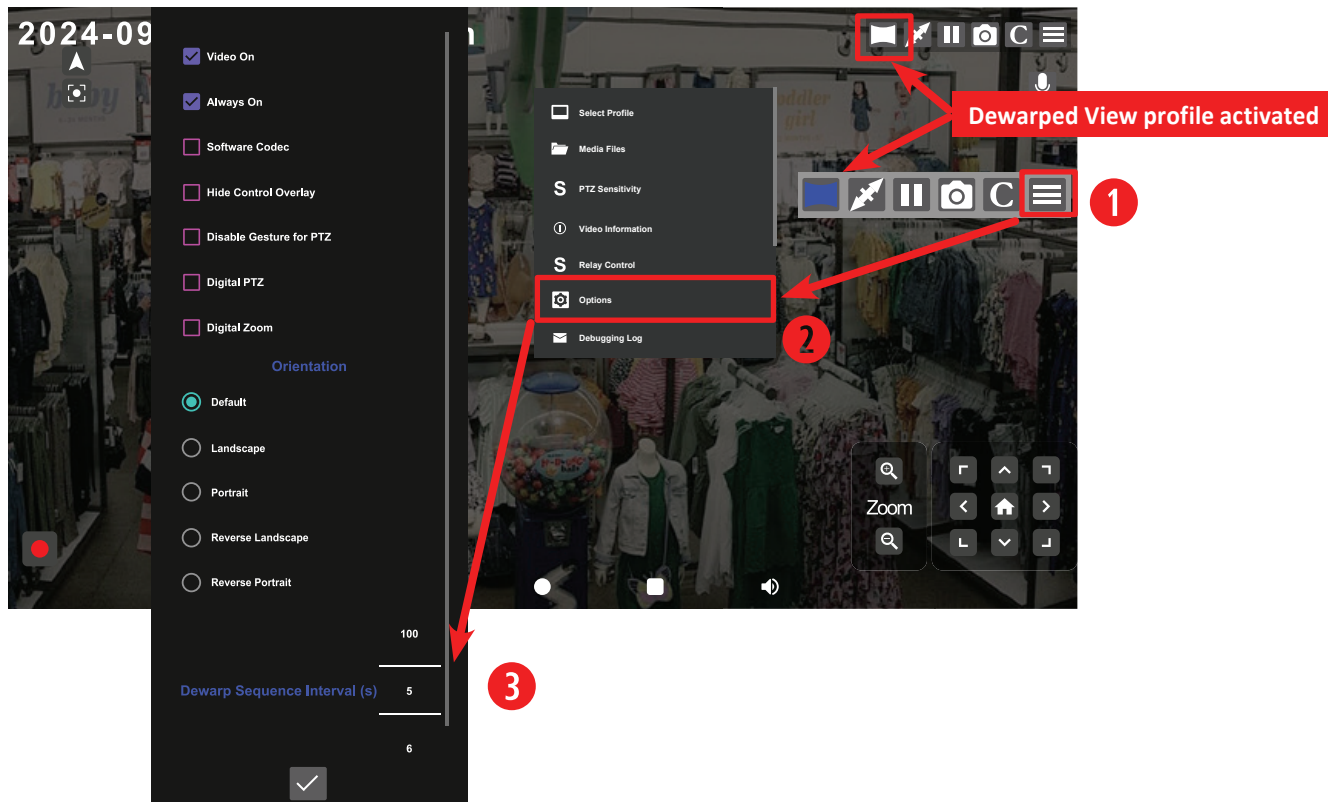

- If user select one of the Profile\_L2S1 ~ Profile\_L2S4, the **Dewarped View** profile is activated and user can see the updated icon on the top right corner.
- On the single view mode, the selected **Dewarped View** profile will be displayed. Thus, if user click the  icon, all **Dewarped View** profiled camera view will be sequentially displayed.
- To adjust the interval time of Dewarped View;
  1. Click '**Menu**'
  2. Click '**Options**'
  3. Select the **interval time** between 5 and 100 seconds

# CONTROL & FUNCTION/BOSCH CAMERA

## Single View - E-PTZ Profile

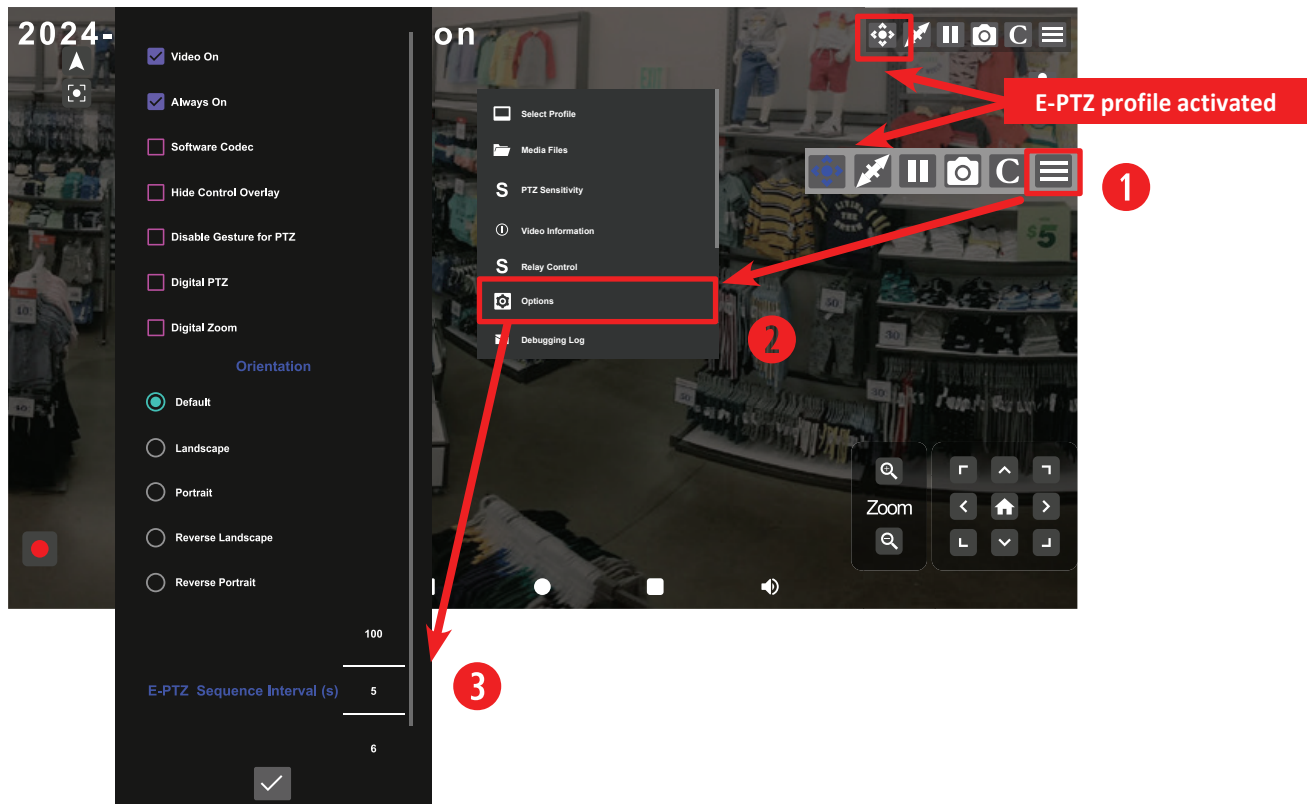

- If user select one of the Profile\_L3S1 ~ Profile\_L3S4, the E-PTZ profile is activated and user can see the updated icon on the top right corner.
- On the single view mode, the selected E-PTZ profile view will be displayed. Thus, if user click the  icon, all E-PTZ profiled camera view will be sequentially displayed.
- To adjust the interval time of E-PTZ;
  1. Click 'Menu'
  2. Click 'Options'
  3. Select the **interval time** between 5 and 100 seconds

# CONTROL & FUNCTION/BOSCH CAMERA

## Sequential View - Launch & Setup

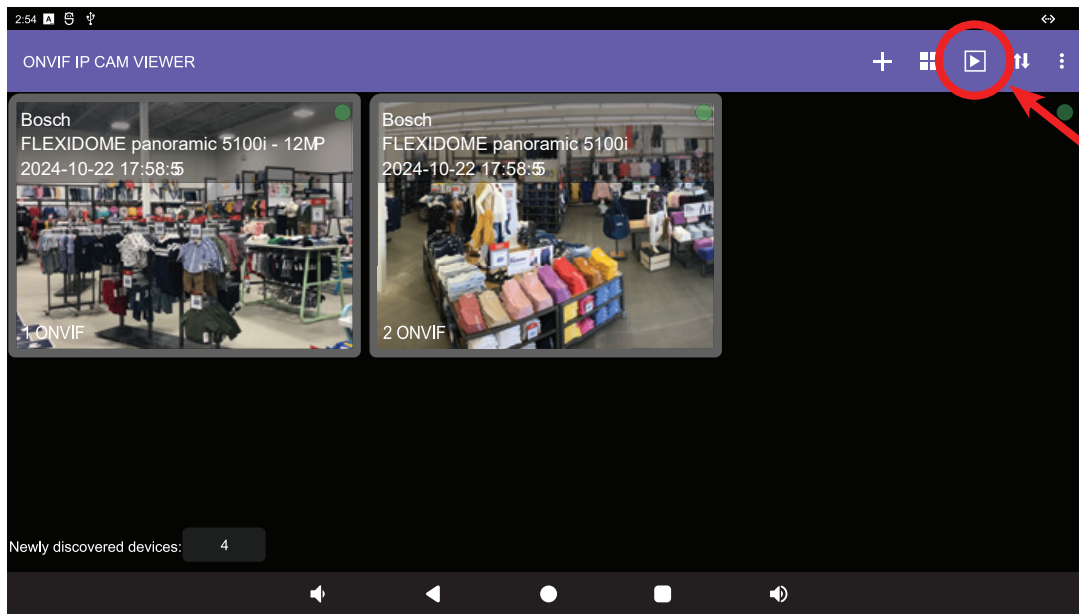

- Click  to start sequential view which show all registered camera streaming based on interval time.

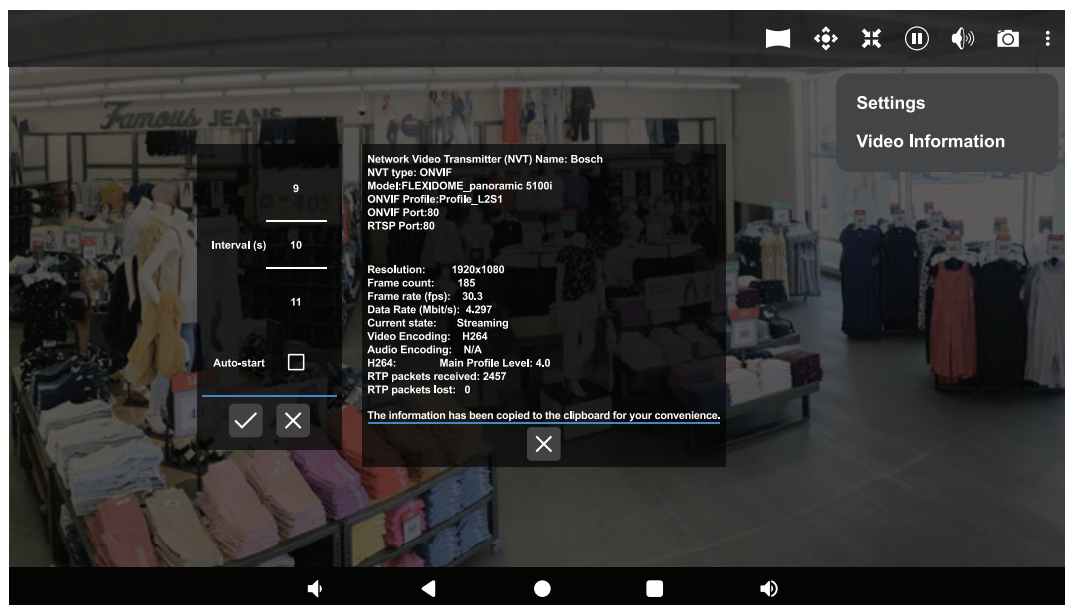





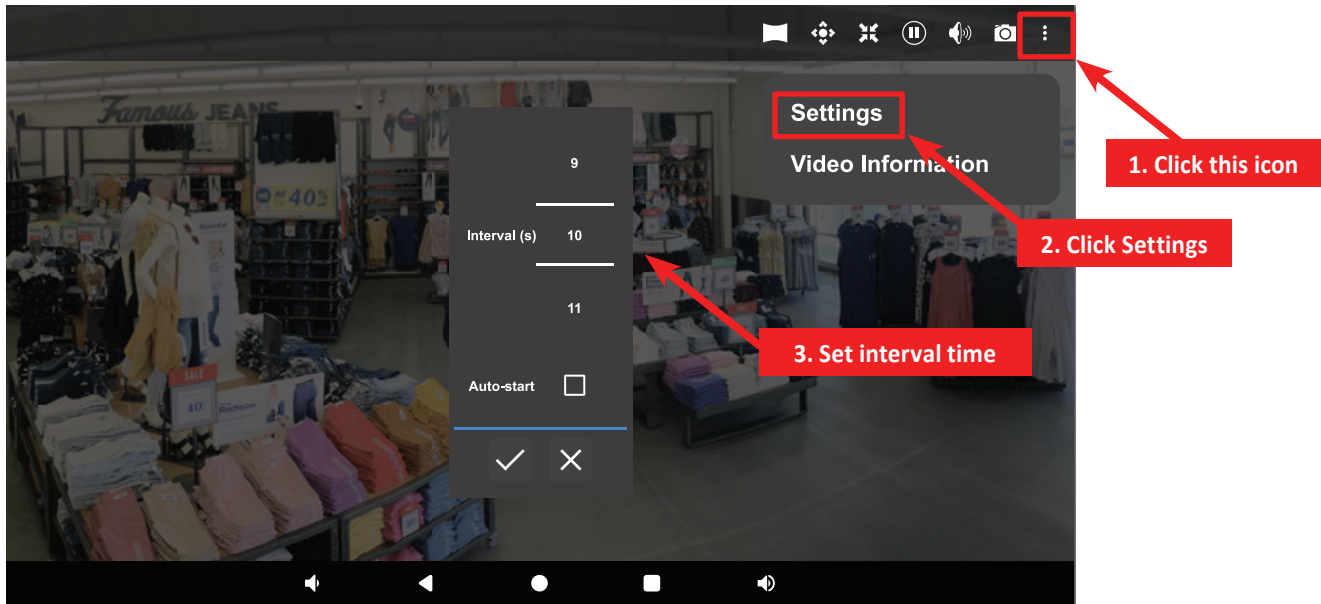

- Click  to set the interval time of sequential view or see the current streaming information.

# CONTROL & FUNCTION/BOSCH CAMERA

## Sequential View - Setup



- Click '**Settings**' to setup the interval time of sequential view. If user check '**Auto-start**', user will see the sequential view when starting **OICV (ONVIF IP Cam Viewer) App**.
- Show the all camera in order. Interval time is set as **5 seconds** as a default. User can set the interval time from 5 to 30 sec.
- Click  to set the aspect ratio based on camera.
- Click  to fill up the video on the monitor.
- Click  to play & stop the sequential streaming.
- Click  to on & off the sound.
- Click  to take a snapshot.
- Click  to add Dewarped View profile on the sequential streaming.
- Click  to add E-PTZ profile on the sequential streaming.

# CONTROL & FUNCTION/BOSCH CAMERA

## Sequential View - Setup

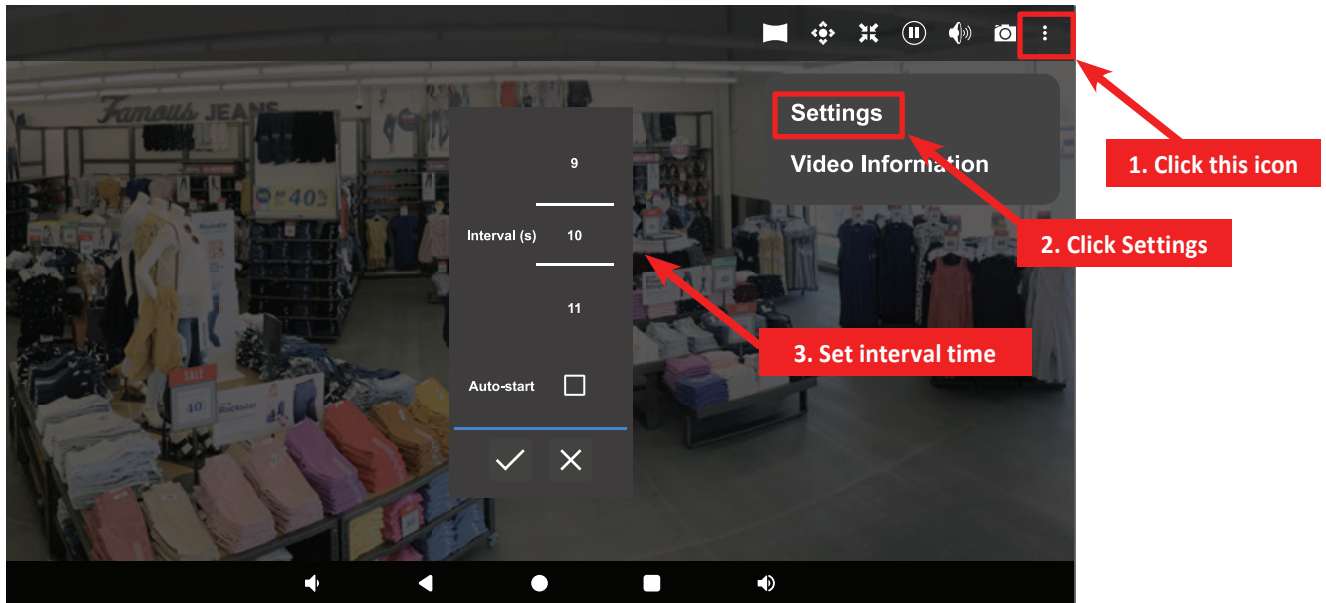

### Interval Time - Dewarped View profile activated

When user set the interval time as **10 sec**, all listed camera will be displayed during 10 seconds.

But, if user added **1 Bosch camera** (activated the **Dewarped Profile**) and **3 general cameras (A, B, C)**, then the sequential view will be playing like below;

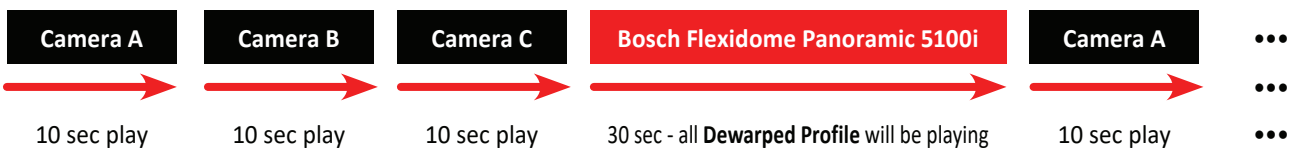

On the sequential view mode, the Dewarped profile playing time of **Bosch Flexidome Panoramic 5100i** is fixed as **30 seconds - 5 seconds** per 1 pre-position of Bosch Flexidome Panoramic 5100i

# CONTROL & FUNCTION/BOSCH CAMERA

## Sequential View - Setup



### Interval Time - E-PTZ profile activated

When user set the interval time as **10 sec**, all listed camera will be displayed during 10 seconds.

But, if user added **1 Bosch camera** (activated the **E-PTZ**) and **3 general cameras (A, B, C)**, then the sequential view will be playing like below;

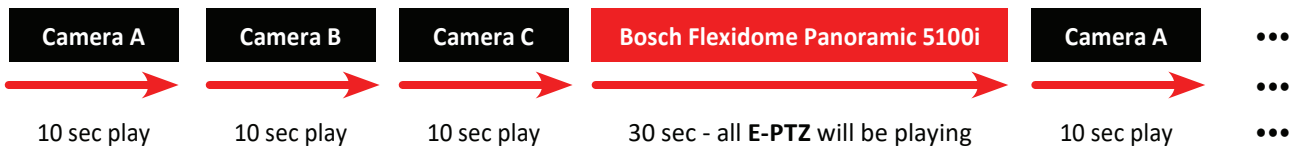

On the sequential view mode, the E-PTZ profile viewing time of **Bosch Flexidome Panoramic 5100i** is fixed as **30 seconds - 5 seconds** per 1 pre-position of Bosch Flexidome Panoramic 5100i



### Interval Time - Dewarped View & E-PTZ profile activated

When user set the interval time as **10 sec**, all listed camera will be displayed during 10 seconds.

But, if user added **2 Bosch cameras** (activated each **Dewarped View & E-PTZ**) and **3 general cameras (A, B, C)**, then the sequential view will be playing like below;



On the sequential view mode, the Dewarped View & E-PTZ profile viewing time of **Bosch Flexidome Panoramic 5100i** is fixed as **30 seconds - 5 seconds** per 1 pre-position of Bosch Flexidome Panoramic 5100i

# CONTROL AND FUNCTION

## Q & A

- **Cannot connect the IP camera / device**

A. Please check the network address and IPM monitor address of IP camera is connected to the local network

- **The screen of camera is slow and lagging**

A. Check the profile of the camera, MJPEG profile could be slow or lagging because of the low fps.

- **Cannot add/register the camera on the ,ultiview screen**

A. When user set up the profile, the limitation of H.264 profile is up to 6. For the smooth process of the profile, please select the low resolution of streaming if network connection is not stable.

- **Cannot save**

A. If there are saved clips through the "File Explorer", check the internal storage is not full.

- **Don't know the camera password**

A. Contact the manufacturer of the camera and try to restore factory default of camera. Then, try again.

- **The screen freeze suddenly**

A. Check the network connection or camera/device status.

# MOUNTING GUIDE

## Wall Mounting (Optional)

VZ-IPM monitors are suitable for VESA wall mount (not included in the delivery).

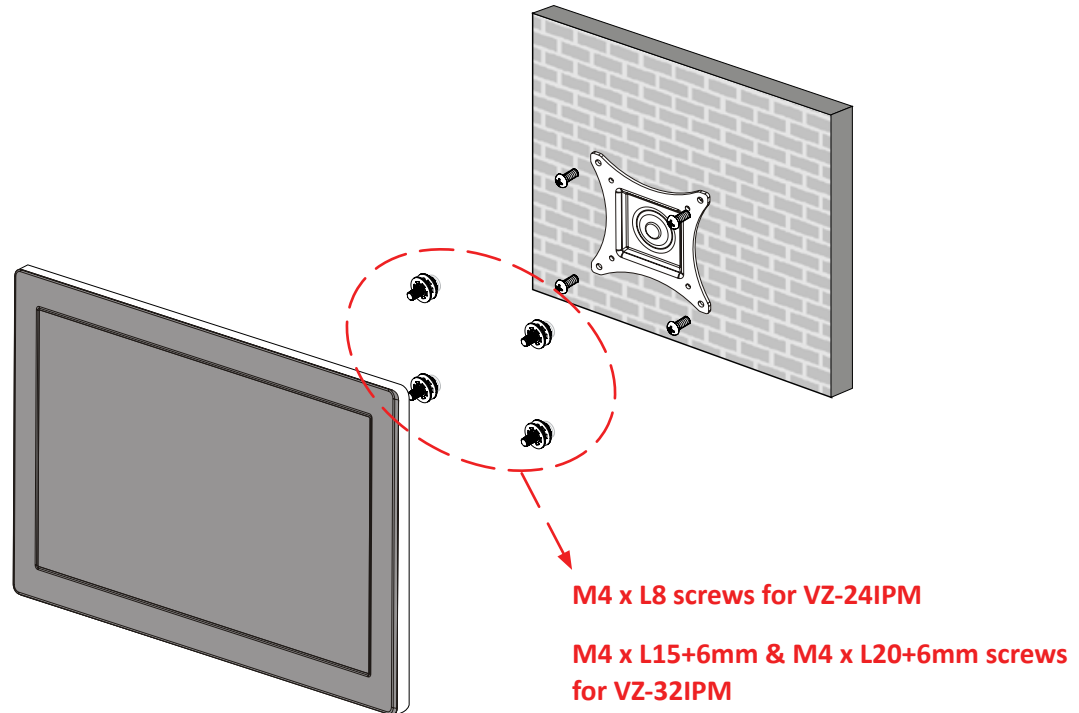

1. VZ-24IPM : VESA WALL MOUNT 100 mm x 100 mm
2. VZ-32IPM : VESA WALL MOUNT 75 mm x 75 mm

### ! Attention!

VZ-24IPM : You must use 4 \* M4 x L8 screws to assemble this monitor and the wall mount bracket.

VZ-32IPM : You must use 2 \* (M4 x L15+6) / 2 \* (M4 x L20+6) screws to assemble this monitor and the wall mount bracket.

### ! WARNING !

If user uses screws longer than M4 x L8 mm for VZ-24IPM, M4 x L15+6 mm / M4 x L20+6 mm for VZ-32IPM, it may cause damage to the unit. Please use bolt of correct size and length as instructed.



### Mounting Safety !

At least two people are recommended to safely install the mount.

# SPECIFICATION

Model No.		VZ-24IPM	VZ-32IPM
Size & Type		23.8"	32"
LCD	Panel Type	23.8" LED Backlit Monitor	32" LED Backlit Monitor
	Pixel Pitch	0.2745 (H) x 0.2745 (V) mm	0.18159 (H) x 0.18159 (V) mm
	Brightness	250 cd/m <sup>2</sup>	350 cd/m <sup>2</sup>
	Contrast Ratio	1000 : 1(Typ.)	1000 : 1(Typ.)
	Viewing Angle	R/L : 89°/ 89° U/D : 89°/ 89°	R/L : 89°/ 89° U/D : 89°/ 89°
	Display Color	16.7 Million Colors	16.7 Million Colors
	Response Time	< 14 ms	< 14 ms
	Active Display Area	527.04 (H) x 296.46 (V) mm	697.305 (H) x 392.234 (V) mm
	Resolution	1920 (H) x 1080 (V)	3840 (H) x 2160 (V)
Aspect Ratio	16 : 9	16 : 9	
Case Type		Black Plastic	Black Plastic
Speaker		2 x 3W	2 x 3W
Operating Temperature		14°F ~ 122°F / -10°C ~ 50°C	32°F ~ 140°F / 0°C ~ 60°C
Operating Humidity		20 ~ 70% RH	
Weight		Net : 8.26 lb / 3.75 kg Gross : 12.23 lb / 5.55 kg	Net : 14.33 lb / 6.5 kg Gross : 19.4 lb / 8.8 kg
INTERFACE		Ethernet 10/100 (RJ-45 x 1 (PoE)) In x 1, USB 2.0 (Type-A) In x 1, USB 3.0 (Type-A) In x 1, USB (Type-C) In x 1, Audio Out x 1, I/O (Reset) x 1, Micro SD In x 1, HDMI (High Definition Multimedia Interface) In / Out x 1 / 1	
Safety & EMC Certification		CE / FCC / KCC / RoHS	
Electrical Ratings	PoE IN	PoE ++ (Type 3) 52V DC	-
	DC 12V IN	12V DC, 4A (AC 100-240V, 50/60Hz (with DC Adaptor))	12V DC, 5A (AC 100-240V, 50/60Hz (with DC Adaptor))
Power Consumption		≤ 32 W	≤ 43 W
Accessories		Power Supply & Cable, User's Manual, Remote Controller	

# TERMS OF WARRANTY / RMA

- The warranty period for this monitor is 3 years. The warranty will be voided for the scenarios listed below.
- You can also download the manual and information of VIEWZ web site: VIEWZUSA.COM

Cases of Non-Warranty Coverage	When power feed to the monitor exceeds capacity and causes damage
	Accident, Abuse, Misuse, Neglect, Fire, Water/liquids, Lightning or any act of nature
	Damaged by dropping, throwing and hitting the monitor
	Failure caused by users attempt to modify the product
	Failure by limited life of parts such as LED Lamps and any other consumables
	Damaged by using third party power cable, unstable power input and electric shock

\* Above information can be changed without notification - please check our website or contact ViewZ representative for latest RMA service policy.

\* When shipping the monitor for RMA, make sure to pack safely to ensure the monitor is not damaged during shipping.





# WARRANTY

## ViewZ USA LIMITED 3 YEAR WARRANTY

### What and Who is Covered by this Limited Warranty and for How Long

ViewZ USA warrants this product to be free from defects in material and workmanship for 3 years to the original owner of this product. The limited warranty is valid only for the original purchaser of the product.

### What ViewZ USA Will Do

At the sole discretion of ViewZ USA, ViewZ USA will repair or replace any product or product part that is defective. If ViewZ USA chooses to replace a defective product or part, a replacement product or part will be shipped to you at no charge, but you must pay any labor costs.

### What is Not Covered; Limitations

ViewZ USA disclaims any liability for damage to mounts, adapters, displays, projectors, other property, or personal injury resulting, in whole or in part, from improper installation, modification, use or misuse of its products.

ViewZ USA disclaims all other warranties, express or implied, including warranties of merchantability and fitness for a particular purpose. ViewZ USA is not responsible for incidental or consequential damages, including but not limited to, inability to use its products or labor costs for removing and replacing defective products or parts. Some states do not allow the exclusion or limitation of incidental or consequential damage, so the above limitation or exclusion may not apply to you.

### What Customers Must Do for Limited Warranty Service

If you discover a problem that you think may be covered by the warranty you MUST REPORT it in writing to the address below within thirty (30) days. Proof of purchase (an original sales receipt) from the original consumer purchaser must accompany all warranty claims. Warranty claims must also include a description of the problem, the purchaser's name, address, and telephone number. General inquiries can be addressed to ViewZ USA Customer Service at 1-888-998-4399. Warranty claims will not be accepted over the phone or by fax.

ViewZ USA  
Attn: Warranty Claim  
1030 N ARMANDO ST.,  
ANAHEIM, CA 92806

### How State Law Applies

This warranty gives you specific legal rights, and you may also have other rights which vary from state to state.

### Disclaimer

ViewZ USA intends to make this manual accurate and complete. However, ViewZ USA makes no claim that the information contained herein covers all details, conditions or variations, nor does it provide for every possible contingency in connection with the installation or use of this monitor. The information contained in this document is subject to change without notice or obligation of any kind. ViewZ USA makes no representation of warranty, expressed or implied, regarding the information contained herein. ViewZ USA assumes no responsibility for accuracy, completeness or sufficiency of the information contained in this document.

### Contact Us

**NORTH AMERICA**  
1030 N ARMANDO ST.,  
ANAHEIM, CA 92806  
USA and Canada  
Phone: 1-888-998-4399  
Fax: 1-714-996-1138  
Other Locations  
Phone: (001) 888-998-4399  
Fax: (001) 714-996-1138

© ViewZ USA