

# **Nikon**

DIGITAL CAMERA

# COOLPIX P1100

## Reference Guide

- Read this document thoroughly before using the camera.
- To ensure proper use of the camera, be sure to read "For your safety" (page 16).
- After reading this document, keep it readily accessible for future reference.

En

# Types of documents

The following documents are available for this camera.

Documents	Description
<b>Reference Guide (this document)</b>	Explains details about using the camera.
<b>SnapBridge Online Help</b>	Explains details about using the app for smart devices, "SnapBridge". <a href="https://nikonimglib.com/snbr/onlinehelp/en/index.html">https://nikonimglib.com/snbr/onlinehelp/en/index.html</a>
<b>NX Studio Online Help</b>	Explains details about using the computer software, "NX Studio". <a href="https://nikonimglib.com/nxstdo/onlinehelp/en/index.html">https://nikonimglib.com/nxstdo/onlinehelp/en/index.html</a>
<b>User's Manual</b>	A manual included with the camera. Explains preparation for shooting and basic operations.

# Table of contents

Types of documents .....	2
<b>Introduction</b>	<b>11</b>
Package contents .....	11
Read this first .....	12
Descriptions in this document .....	12
Notices .....	12
For your safety .....	16
<b>Parts of the camera</b>	<b>25</b>
The camera body .....	25
Principle functions of the controls .....	28
The monitor/viewfinder .....	33
Shooting screen .....	33
Playback screen .....	38
Tone level information .....	39
Switching the information displayed on the screen ( <b>DISP</b> button) .....	41
For shooting .....	41
For playback .....	43
Power-on lamp (charge lamp) .....	44
<b>Getting started</b>	<b>46</b>
Attaching the strap .....	46
Attaching/removing the lens cap and lens hood .....	47
Inserting the battery and memory card .....	48
Removing the battery or memory card .....	49
Memory cards that can be used .....	49
Charging the battery .....	51
Opening the monitor .....	54
Camera setup .....	55

## Basic operations of shooting and playback **58**

---

Shooting still images .....	58
Using the built-in flash .....	64
Recording movies .....	65
Switching between the monitor and viewfinder .....	66
Playing back images .....	68
Deleting images .....	70

## Shooting features **74**

---

Selecting a shooting mode (mode dial) .....	74
Auto mode (standard shooting) .....	76
<b>P, S, A, and M</b> modes .....	77
Tips for setting exposure .....	79
The control range of the shutter speed ( <b>P, S, A, and M</b> modes) .....	83
Shooting with the Bulb setting or Time setting (when in <b>M</b> mode) ....	85
<b>U</b> (user settings) mode .....	87
Saving settings in <b>u</b> mode (Save user settings) .....	87
List of setting options that can be saved in <b>u</b> mode ...	88
Creative mode (applying effects when shooting) .....	91
Scene mode (shooting suited to the shooting conditions) .....	94
Bird-watching .....	96
Moon .....	97
Portrait .....	99
Landscape .....	99
Sports .....	100
Night portrait .....	101
Party/indoor .....	102
Beach .....	102
Snow .....	102
Sunset .....	102
Dusk/dawn .....	103

Night landscape .....	103
Close-up .....	105
Food .....	106
Fireworks show .....	107
Backlighting .....	108
Easy panorama .....	109
Pet portrait .....	113
Soft .....	115
Selective color .....	115
Multiple exp. Lighten .....	116
Setting the flash mode, self-timer, focus mode, and exposure compensation .....	120
Flash mode .....	122
Available flash modes .....	123
Self-timer .....	127
Smile timer .....	130
Using autofocus .....	132
Selecting the focus mode .....	132
The shutter-release button .....	134
Using target finding AF .....	134
Using face detection .....	136
Using skin softening .....	137
Subjects not suitable for autofocus .....	137
Focus lock .....	138
Using manual focus .....	140
Exposure compensation .....	144
Default settings (flash, self-timer, and focus mode) .....	146
Using the <b>F<sub>n</sub></b> (function) button .....	149
Assigning menu options to the <b>F<sub>n</sub></b> buttons of the ML-L7 Remote Control (available separately) .....	151
Using the zoom .....	152
Using the zoom control .....	152
Using the side zoom control .....	153

Using the snap-back zoom (temporarily widening the visible range) .....	154
Functions that cannot be used simultaneously when shooting .....	156

## **Playback features** **162**

---

Playback zoom .....	162
Crop .....	164
Thumbnail playback/calendar display .....	166
Viewing and deleting images captured continuously (sequence) .....	168
Viewing images in a sequence .....	168
Deleting images in a sequence .....	170
Playback with easy panorama .....	171
Editing images (still images) .....	173
Before editing images .....	173
Printing still images .....	174

## **Movies** **175**

---

Basic operations of movie recording and movie playback .....	175
Capturing still images while recording movies .....	181
Movie manual .....	183
Time-lapse movie .....	187
Superlapse movie .....	190
Operations during movie playback .....	192
Editing movies .....	194
Extracting only the desired portion of a movie .....	194
Saving a frame from a movie as a still image .....	195

## **Using the menu** **197**

---

Menu operations .....	197
Menu lists .....	201
The shooting menu .....	201
The Movie manual mode menu .....	203
The movie menu .....	204
The playback menu .....	205

The network menu .....	206
The setup menu .....	207
The shooting menu (common across shooting modes) .....	209
Image quality .....	209
Image size .....	212
The shooting menu ( <b>P</b> , <b>S</b> , <b>A</b> , <b>M</b> , or <b>U</b> mode) .....	213
Picture Control .....	213
Custom Picture Control .....	217
White balance .....	219
Metering .....	223
Continuous .....	224
ISO sensitivity .....	229
Exposure bracketing .....	231
AF area mode .....	232
Autofocus mode .....	237
Flash exp. comp. ....	238
Noise reduction filter .....	239
Long exposure NR .....	239
Active D-Lighting .....	240
Multiple exposure .....	241
Zoom memory .....	243
Startup zoom position .....	245
M exposure preview .....	245
The Movie manual mode menu .....	246
The movie menu .....	247
Movie options .....	247
Autofocus mode .....	251
Electronic VR .....	252
Wind noise reduction .....	252
Zoom microphone .....	253
Frame rate .....	254
External mic sensitivity .....	254
The playback menu .....	256

Mark for upload .....	256
Quick retouch .....	257
D-Lighting .....	258
Skin softening .....	259
Filter effects .....	260
Slide show .....	263
Protect .....	264
Rotate image .....	266
Small picture .....	268
Sequence display options .....	269
Choose key picture .....	269
The network menu .....	270
Network menu list .....	270
Text entry .....	273
The setup menu .....	274
Time zone and date .....	274
Slot empty release lock .....	276
Monitor settings .....	277
EVF auto toggle .....	281
Date stamp .....	281
Self-timer: after release .....	282
Vibration reduction .....	283
AF assist .....	284
Digital zoom .....	285
Assign side zoom control .....	285
Snap-back zoom .....	286
Control ring options .....	286
AE/AF lock button .....	287
Sound settings .....	288
Auto off .....	289
Format card .....	289
Language .....	289
HDMI .....	290

Charge by computer .....	292
Image comment .....	294
Copyright information .....	295
Location data .....	296
Toggle Av/Tv selection .....	297
Reset file numbering .....	297
Peaking .....	298
Reset all .....	299
Conformity marking .....	299
Firmware version .....	300

## **Connecting to smart devices 301**

---

The SnapBridge app .....	301
What SnapBridge can do for you .....	301
Wireless connections .....	303
Connecting via Bluetooth (pairing) .....	303
Switching to Wi-Fi connection .....	307

## **Connecting the camera to a TV or computer 309**

---

Viewing images on a TV .....	309
Transferring images to a computer .....	312
Installing NX Studio .....	312
Copying pictures to a computer using NX Studio .....	312

## **Accessories 317**

---

List of accessories .....	317
EH-5d AC Adapter and EP-5C Power Connector .....	320
Attaching the EH-5d AC Adapter and EP-5C Power Connector .....	320
Speedlights (external flash units) .....	322
ML-L7 Remote Control .....	325

## **If there is a problem 332**

---

Troubleshooting .....	332
-----------------------	-----

Power, display, settings .....	332
Shooting .....	335
Playback, editing .....	339
TVs, computers, printers .....	340
Smart devices, SnapBridge app, ML-L7 Remote Control .....	341
Error messages .....	345
<b>Technical notes</b>	<b>348</b>
<hr/>	
Compliance information .....	348
Caring for the product .....	357
The camera .....	357
The battery .....	359
Memory cards .....	361
Cleaning and storage .....	363
Cleaning .....	363
Storage .....	363
File names .....	365
Specifications .....	367
Nikon COOLPIX P1100 Digital Camera .....	367
Trademarks and licenses .....	376
<b>Index</b>	<b>378</b>
<hr/>	

# Introduction

## Package contents

Be sure all items listed here were included with your camera.

Camera



EN-EL20a Rechargeable Li-ion Battery

UC-E24 USB Cable (☞312)

Warranty

User's Manual

AN-DC3 Strap (☞46)

LC-77 Lens Cap

HB-CP1 Lens Hood

• Memory cards are sold separately.

### The Nikon Download Center



Visit the Nikon Download Center to download firmware for cameras, NX Studio and other Nikon software, and documentation for Nikon products including cameras and flash units.

<https://downloadcenter.nikonimglib.com/>

# Read this first

## Descriptions in this document

- Symbols

Symbol	Description
	This icon marks cautions and information that should be read before using the camera.
<b>Tip</b>	This icon marks notes and information that should be read before using the camera.
	This icon marks other pages containing relevant information.

- SD, SDHC, and SDXC memory cards are referred to as “memory cards” in this document.
- Smartphones and tablets are referred to as “smart devices.”
- The setting at the time of purchase is referred to as the “default setting.”
- The names of menu items displayed on the camera screen, and the names of buttons or messages displayed on a computer screen are enclosed in [ ] (brackets).
- Images are sometimes omitted from screen display samples so that screen indicators can be more clearly shown.

## Notices

- No part of the documentation included with this product may be reproduced, transmitted, transcribed, stored in a retrieval system, or translated into any language in any form, by any means, without Nikon’s prior written permission.
- Illustrations and screen content shown in this documentation may differ from the actual product.

- Nikon reserves the right to change the appearance and specifications of the hardware and software described in this documentation at any time and without prior notice.
- Nikon will not be held liable for any damages resulting from the use of this product.
- While every effort has been made to ensure that the information in this documentation is accurate and complete, we would appreciate it were you to bring any errors or omissions to the attention of the Nikon representative in your area (address provided separately).

### • **Notice concerning prohibition of copying or reproduction**

Note that simply being in possession of material that has been digitally copied or reproduced by means of a scanner, digital camera, or other device may be punishable by law.

#### • **Items prohibited by law from being copied or reproduced**

Do not copy or reproduce paper money, coins, securities, government bonds, or local government bonds, even if such copies or reproductions are stamped "Sample".

The copying or reproduction of paper money, coins, or securities which are circulated in a foreign country is prohibited.

Unless the prior permission of the government has been obtained, the copying or reproduction of unused postage stamps or post cards issued by the government is prohibited.

The copying or reproduction of stamps issued by the government and of certified documents stipulated by law is prohibited.

#### • **Cautions on certain copies and reproductions**

The government has issued cautions on copies or reproductions of securities issued by private companies (shares, bills, checks, gift certificates, etc.), commuter passes, or coupon tickets, except when a minimum of necessary copies are to be provided for business use by a company. Also, do not copy or reproduce passports issued by the government, licenses issued by public agencies and private groups, ID cards, and tickets, such as passes and meal coupons.

#### • **Comply with copyright notices**

Under copyright law, photographs or recordings of copyrighted works made with the camera cannot be used without the permission of the copyright holder. Exceptions apply to personal use, but note that even personal use may be restricted in the case of photographs or recordings of exhibits or live performances.

### ● **Nikon brand accessories**

This product is designed to be used with Nikon brand accessories. Nikon is not responsible for any damage caused by accidents such as malfunctions or ignition that are clearly attributable to the use of non-Nikon accessories. In these cases, repair of Nikon products is not covered under your Nikon warranty. Please understand this in advance.

### ● **Batteries**

EN-EL20a rechargeable Li-ion batteries are dedicated for use only with Nikon products. Nikon is not responsible for any malfunctions or accidents resulting from use with chargers or other products that are not compatible with the EN-EL20a.

- Beware of counterfeit batteries. Such batteries do not allow the camera to perform to its full potential and may cause the batteries to overheat, ignite, rupture or leak.
- An EN-EL20a Rechargeable Li-ion Battery bears a Nikon holographic seal indicating that it is a genuine Nikon product.



### ● **Disposing of data storage devices**

Please note that deleting images or formatting data storage devices such as memory cards does not completely erase the original image data. Deleted files can sometimes be recovered from discarded storage devices using commercially available software, potentially resulting in the malicious use of personal image data. Ensuring the privacy of such data is the user's responsibility.

Before discarding a data storage device or transferring ownership to another person, make sure to reset all of the camera's settings in the setup menu → **[Reset all]**. After resetting, erase all data in the device using commercial deletion software, or format the device in the setup menu → **[Format card]**, then completely refill it with images containing no private information (for example, images of empty sky). Care should be taken to avoid injury or damage to property when physically destroying memory cards.

---

### ✔ **Before taking important pictures**

Before taking pictures on important occasions (such as at weddings or before taking the camera on a trip), take a test shot to ensure that the camera is functioning normally. Nikon will not be held liable for damages or lost profits that may result from product malfunction.

### ✔ **Life-long learning**

As part of Nikon's "Life-long learning" commitment to ongoing product support and education, continually-updated information is available on-line at the following sites:

- **For users in the U.S.A.:** <https://www.nikonusa.com/>
- **For users in Canada:** <https://www.nikon.ca/>
- **For users in Mexico:** <https://www.nikon.com.mx/>
- **For users in Latin America:** <https://www.nikonamericalatina.com/>
- **For users in Europe:** <https://www.nikoneurope.com>
- **For users in Asia, Oceania, the Middle East, and Africa:** <https://www.nikon-asia.com/>

Visit these sites to keep up-to-date with the latest product information, tips, answers to frequently-asked questions (FAQs), and general advice on digital imaging and photography. Additional information may be available from the Nikon representative in your area. See the following URL for contact information: <https://imaging.nikon.com/>

---

## For your safety

To prevent damage to property or injury to yourself or to others, read “For your safety” in its entirety before using this product.

After reading these safety instructions, keep them readily accessible for future reference.

 **DANGER:** Failure to observe the precautions marked with this icon carries a high risk of death or severe injury.

 **WARNING:** Failure to observe the precautions marked with this icon could result in death or severe injury.

 **CAUTION:** Failure to observe the precautions marked with this icon could result in injury or property damage.



### WARNING

---

**Do not use while walking or operating a vehicle.**

Failure to observe this precaution could result in accidents or other injury.

---

**Do not disassemble or modify this product. Do not touch internal parts that become exposed as the result of a fall or other accident.**

Failure to observe these precautions could result in electric shock or other injury.

---

**Should you notice any abnormalities such as the product producing smoke, heat, or unusual odors, immediately remove the battery or disconnect the power source.**

Continued operation could result in fire, burns or other injury.

---

**Keep dry. Do not handle with wet hands. Do not handle the plug with wet hands.**

Failure to observe these precautions could result in fire or electric shock.

---

**Do not let your skin remain in prolonged contact with this product while it is on or plugged in.**

Failure to observe this precaution could result in low-temperature burns.

---

**Do not use this product in the presence of flammable dust or gas such as propane, gasoline or aerosols.**

Failure to observe this precaution could result in explosion or fire.

---

**Do not aim the flash at the operator of a motor vehicle.**

Failure to observe this precaution could result in accidents.

---

**Keep this product out of reach of children.**

Failure to observe this precaution could result in injury or product malfunction. In addition, note that small parts constitute a choking hazard. Should a child swallow any part of this product, seek immediate medical attention.

---

**Do not entangle, wrap or twist the straps around your neck.**

Failure to observe this precaution could result in accidents.

---

**Do not use batteries, chargers, AC adapters, or USB cables not specifically designated for use with this product. When using batteries, chargers, AC adapters, and USB cables designated for use with this product, do not:**

- **Damage, modify, forcibly tug or bend the cords or cables, place them under heavy objects, or expose them to heat or flame.**
- **Use travel converters or adapters designed to convert from one voltage to another or with DC-to-AC inverters.**

Failure to observe these precautions could result in fire or electric shock.

---

**Do not handle the plug when charging the product or using the AC adapter during thunderstorms.**

Failure to observe this precaution could result in electric shock.

---

**Dust on or near the metal parts of the plug should be removed with a dry cloth.**

Continued use could result in fire.

---

**Do not handle with bare hands in locations exposed to extremely high or low temperatures.**

Failure to observe this precaution could result in burns or frostbite.

---

 **CAUTION**

**Do not leave the lens pointed at the sun or other strong light sources.**

Light focused by the lens could cause fire or damage to product's internal parts. When shooting backlit subjects, keep the sun well out of the frame. Sunlight focused into the camera when the sun is close to the frame could cause fire.

---

**Turn this product off when its use is prohibited. Disable wireless features when the use of wireless equipment is prohibited.**

The radio-frequency emissions produced by this product could interfere with equipment onboard aircraft or in hospitals or other medical facilities.

---

**Remove the battery and disconnect the AC adapter if this product will not be used for an extended period.**

Failure to observe this precaution could result in fire or product malfunction.

---

**Do not touch moving parts of the lens or other moving parts.**

Failure to observe this precaution could result in injury.

---

**Do not fire the flash in contact with or in close proximity to the skin or objects.**

Failure to observe this precaution could result in burns or fire.

---

**Do not raise the built-in flash when using a flash unit mounted on the camera accessory shoe.**

Failure to observe this precaution could result in fire or product malfunction.

---

**Do not leave the product where it will be exposed to extremely high temperatures for an extended period, such as in an enclosed automobile or in direct sunlight.**

Failure to observe this precaution could result in fire or product malfunction.

---

**Do not transport the camera with a tripod or similar accessory attached.**

Failure to observe this precaution could result in injury or product malfunction.

---

**Keep the product at least 5 cm (2.0 in.) from pacemakers and other medical devices.**

Medical devices in close proximity could be affected by the magnet or magnets in the product.

---



## **DANGER (Batteries)**

**Do not mishandle batteries.**

Failure to observe the following precautions could result in the batteries leaking, overheating, rupturing, or catching fire:

- Use only rechargeable batteries approved for use in this product.
  - Do not expose batteries to flame or excessive heat.
  - Do not disassemble.
  - Do not short-circuit the terminals by touching them to necklaces, hairpins, or other metal objects.
  - Do not expose batteries or the products in which they are inserted to powerful physical shocks.
  - Do not step on batteries, pierce them with nails, or strike them with hammers.
- 

**Charge only as indicated.**

Failure to observe this precaution could result in the batteries leaking, overheating, rupturing, or catching fire.

---

**If battery liquid comes into contact with the eyes, rinse with plenty of clean water and seek immediate medical attention.**

Delaying action could result in eye injuries.

---

**Follow the instructions of airline personnel.**

Batteries left unattended at high altitudes in an unpressurized environment may leak, overheat, rupture, or catch fire.

---



## **WARNING (Batteries)**

**Keep batteries out of reach of children.**

Should a child swallow a battery, seek immediate medical attention.

---

**Keep batteries out of reach of household pets and other animals.**

The batteries could leak, overheat, rupture, or catch fire if bitten, chewed, or otherwise damaged by animals.

---

**Do not immerse batteries in water or expose to rain.**

Failure to observe this precaution could result in fire or product malfunction. Immediately dry the product with a towel or similar object should it become wet.

---

**Discontinue use immediately should you notice any changes in the batteries, such as discoloration or deformation. Cease charging EN-EL20a rechargeable batteries if they do not charge in the specified period of time.**

Failure to observe these precautions could result in the batteries leaking, overheating, rupturing, or catching fire.

---

**When batteries are no longer needed, insulate the terminals with tape.**

Overheating, rupture, or fire may result should metal objects come into contact with the terminals.

---

**If battery liquid comes into contact with a person's skin or clothing, immediately rinse the affected area with plenty of clean water.**

Failure to observe this precaution could result in skin irritation.

---

- **WARNING for customers in the U.S.A.**



This product contains a non-replaceable button cell or coin battery inside. Recycle or dispose of this product in accordance with local regulations. Never attempt to disassemble the product to remove the battery.

## **WARNING**

- **INGESTION HAZARD:** This product contains a button cell or coin battery.
- **DEATH** or serious injury can occur if ingested.
- A swallowed button cell or coin battery can cause **Internal Chemical Burns** in as little as **2 hours**.
- **KEEP** new and used batteries **OUT OF REACH of CHILDREN**
- **Seek immediate medical attention** if a battery is suspected to be swallowed or inserted inside any part of the body.





- Remove and immediately recycle or dispose of used batteries according to local regulations and keep away from children. Do NOT dispose of batteries in household trash or incinerate.
- Even used batteries may cause severe injury or death.
- Call a local poison control center for treatment information.
- Battery type: Manganese lithium rechargeable coin battery
- Nominal voltage: 3.0 V
- Non-rechargeable batteries are not to be recharged.
- Do not force discharge, recharge, disassemble, heat above 60 °C (140 °F) or incinerate.

Doing so may result in injury due to venting, leakage or explosion resulting in chemical burns.

# Parts of the camera

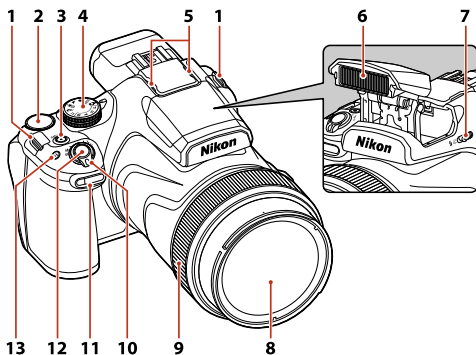
## The camera body



- 1 Eyelet for camera strap (☐46)
- 2 Command dial
- 3 Power switch/power-on lamp (charge lamp) (☐44, ☐51, ☐55)
- 4 Mode dial (☐74)
- 5 Microphone (stereo) (☐175, ☐253)
- 6 Built-in flash (☐64, ☐122)
- 7  (flash pop-up) control (☐64, ☐122)
- 8 Lens
- 9 Control ring (☐286)

- 10 Zoom control
  - **W**: Wide-angle (☐152)
  - **T**: Telephoto (☐152)
  - : Thumbnail playback (☐166)
  - **Q**: Playback zoom (☐162)
- 11 Self-timer lamp (☐127, ☐130)  
Red-eye reduction lamp (☐125)  
AF-assist illuminator (☐284)
- 12 Shutter-release button (☐58, ☐134)
- 13 Fn (function) button (☐149)

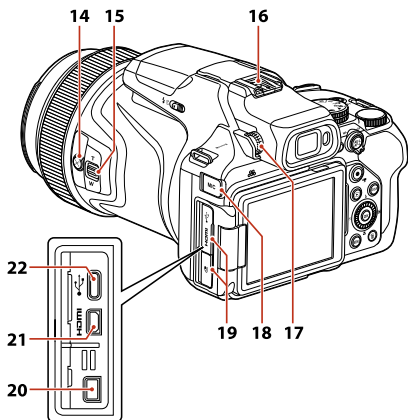

14  (snap-back zoom) button  
(☐154)

15 Side zoom control (☐153)  
 • **W**: Wide-angle  
 • **T**: Telephoto

16 Accessory shoe (☐318, ☐322)

17 Diopter adjustment control  
(☐66)

18 External microphone connector  
cover









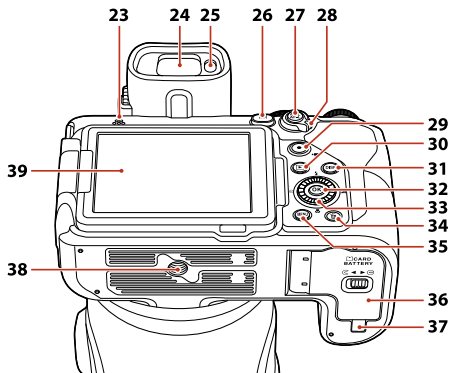

19 Connector cover (☐51, ☐309,  
☐312)

20 Accessory terminal (☐318)





21 HDMI micro connector (Type D)  
(☐309)





22 USB connector (☐51, ☐312)







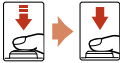

- |   |   |
|---|---|
| <p><b>23</b> Speaker (□192, □288)</p> <p><b>24</b> Electronic viewfinder (□66)</p> <p><b>25</b> Eye sensor (□66)</p> <p><b>26</b>  (monitor) button (□66)</p> <p><b>27</b>  (AE-L/AF-L) button (□138, □287)</p> <p><b>28</b> Focus-mode selector (□132, □140)</p> <p><b>29</b>  (movie-record) button (□65, □175)</p> <p><b>30</b>  (playback) button (□68)</p> <p><b>31</b> <b>DISP</b> (display) button (□41)</p> | <p><b>32</b>  (apply selection) button (□197)</p> <p><b>33</b> Rotary multi selector (multi selector) (□120, □197)<br/>Pressing up, down, left, or right on the multi selector is expressed as , , , or .</p> <p><b>34</b>  (delete) button (□70)</p> <p><b>35</b> <b>MENU</b> (menu) button (□197, □201)</p> <p><b>36</b> Battery-chamber/memory card slot cover (□48)</p> <p><b>37</b> Power connector cover (for optional AC adapter) (□317)</p> <p><b>38</b> Tripod socket</p> <p><b>39</b> Monitor (□33, □54)</p> |
|---|---|





# Principle functions of the controls

Control	Main function
 <b>Mode dial</b>	<b>For shooting</b> Select a shooting mode (□74).
 <b>Focus-mode selector</b>	<b>For shooting</b> Select <b>AF</b> (autofocus) or <b>MF</b> (manual focus) (□132, □140).
 <b>AE-L/AF-L (AE-L/AF-L) button</b>	<b>For shooting</b> Lock the exposure or focus (□138, □287).
 <b>Zoom control</b>	<b>For shooting</b> Move toward <b>T</b> (Q) (telephoto) to zoom in closer to the subject, and move toward <b>W</b> (E) (wide-angle) to zoom out and view a larger area (□152). <b>For playback</b> <ul style="list-style-type: none"><li>• Move toward <b>T</b> (Q) to zoom in on the image, and move toward <b>W</b> (E) to display images as thumbnails or the calendar (□162, □166).</li><li>• Adjust the volume for movie playback.</li></ul>

Control	Main function
 <p data-bbox="114 241 358 307"><b>(snap-back zoom) button</b></p>	<p data-bbox="384 176 532 200"><b>For shooting</b></p> <p data-bbox="384 215 871 240">Widen the angle of view temporarily (□154).</p>
 <p data-bbox="132 572 342 596"><b>Side zoom control</b></p>	<p data-bbox="384 339 532 364"><b>For shooting</b></p> <p data-bbox="384 375 907 441">Use the function assigned in [Assign side zoom control] (□285).</p> <ul data-bbox="394 452 926 659" style="list-style-type: none"> <li>• <b>[Zoom]</b> (default setting): Move toward <b>T</b> (telephoto) to zoom in closer to the subject, and move toward <b>W</b> (wide-angle) to zoom out and view a larger area (□153).</li> <li>• <b>[Manual focus]</b>: When the focus-mode selector is set to <b>MF</b>, adjust the focus manually.</li> </ul>
 <p data-bbox="104 885 368 910"><b>Shutter-release button</b></p>	<p data-bbox="384 690 532 714"><b>For shooting</b></p> <p data-bbox="384 726 884 792">When the button is pressed halfway: Set focus and exposure.</p> <p data-bbox="384 803 900 869">When the button is pressed all the way: Release the shutter (□58, □134).</p> <hr/> <p data-bbox="384 893 532 918"><b>For playback</b></p> <p data-bbox="384 930 664 955">Return to shooting mode.</p>
 <p data-bbox="114 1132 358 1198"><b>(movie-record) button</b></p>	<p data-bbox="384 985 532 1010"><b>For shooting</b></p> <p data-bbox="384 1022 876 1046">Start and stop movie recording (□65, □175).</p> <hr/> <p data-bbox="384 1108 532 1132"><b>For playback</b></p> <p data-bbox="384 1144 664 1169">Return to shooting mode.</p>

Control	Main function
 <p data-bbox="156 663 319 688"><b>Multi selector</b></p>	<p data-bbox="384 110 532 135"><b>For shooting</b></p> <ul data-bbox="394 147 928 569" style="list-style-type: none"> <li>• While the shooting screen is displayed: Display the following setting screens (□120, □197) by pressing: <ul data-bbox="415 256 862 463" style="list-style-type: none"> <li>- Up (▲): ⚡ (flash mode)</li> <li>- Right (▶): ☒ (exposure compensation)</li> <li>- Down (▼): 🌿 (focus mode) (Available only when the focus-mode selector is set to <b>AF</b>.)</li> <li>- Left (◀): ⌚ (self-timer/smile timer)</li> </ul> </li> <li>• When the shooting mode is <b>A</b>, <b>M</b>, or <b>M</b> (Movie manual): Rotate the multi selector to set the f-number.</li> </ul> <hr/> <p data-bbox="384 601 534 626"><b>For playback</b></p> <ul data-bbox="394 637 923 844" style="list-style-type: none"> <li>• While the playback screen is displayed: Change the displayed image using up (▲), down (▼), left (◀), right (▶), or by rotating the multi selector.</li> <li>• While a zoomed image is displayed: Move the display area.</li> </ul> <hr/> <p data-bbox="384 877 510 902"><b>For setting</b></p> <p data-bbox="384 914 912 1013">Select an item using ▲▼◀▶ or by rotating the multi selector, and then apply the selection by pressing the <b>OK</b> button.</p>
 <p data-bbox="125 1227 353 1290"><b>OK (apply selection) button</b></p>	<p data-bbox="384 1049 534 1074"><b>For playback</b></p> <ul data-bbox="394 1086 917 1292" style="list-style-type: none"> <li>• Display individual images of a sequence in full-frame playback mode (□168).</li> <li>• Scroll an image shot with easy panorama.</li> <li>• Play back movies.</li> <li>• Switch from thumbnail playback or zoomed image display to full-frame playback.</li> </ul>

Control	Main function
 <p><b>OK (apply selection) button</b></p>	<p><b>For setting</b> Apply the item that you selected by using the multi selector (□197).</p>
 <p><b>Command dial</b></p>	<p><b>For shooting</b></p> <ul style="list-style-type: none"> <li>• When the shooting mode is <b>P</b> (□77): Set the flexible program.</li> <li>• When the shooting mode is <b>S, M</b> (□77), or <b>[Manual]</b> in  (Movie manual): Set the shutter speed.</li> </ul> <p><b>For playback</b> Change the magnification rate of a zoomed image.</p>
 <p><b>Control ring</b></p>	<p><b>For shooting</b></p> <ul style="list-style-type: none"> <li>• When the focus-mode selector is set to <b>AF</b>: Display the setting screen that is selected in <b>[Control ring options]*</b> (□286).</li> <li>• When the focus-mode selector is set to <b>MF</b>: Adjust the focus manually.</li> </ul> <p>* This function is not available with some shooting modes.</p>
 <p><b>MENU (menu) button</b></p>	<p><b>For shooting/playback</b> Display or close the menu (□197, □201).</p>

Control	Main function
 <b>Fn (function) button</b>	<p><b>For shooting</b>            When the shooting mode is <b>P, S, A, M,</b> or <b>U:</b>            Display or close the setting menus such as  <b>[Continuous]</b> or <b>[Vibration reduction]</b> (□149).</p>
 <b> □  (monitor) button</b>	<p><b>For shooting/playback</b>            Switch between the monitor and viewfinder            (□66).</p>
 <b>DISP (display) button</b>	<p><b>For shooting/playback</b>            Switch or hide the information displayed on the            screen (□41).</p>
 <b>▶ (playback) button</b>	<p><b>For shooting</b>            Play back images (□68).</p> <hr/> <p><b>For playback</b></p> <ul style="list-style-type: none"> <li>• Return to shooting mode.</li> <li>• When the camera is turned off, press and hold down this button to turn the camera on in playback mode (□68).</li> </ul>
 <b>🗑 (delete) button</b>	<p><b>For shooting</b>            Delete the last image that was saved (□70).</p> <hr/> <p><b>For playback</b>            Delete images (□70).</p>

# The monitor/viewfinder

The information that is displayed on the screen changes depending on the camera's settings and state of use.

## Shooting screen

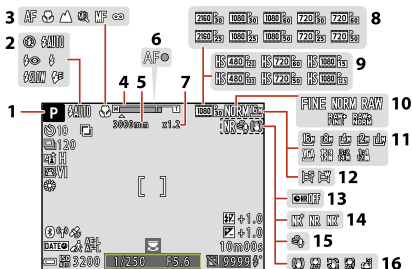

- |   |  |    |   |
|---|--|----|---|
| 1 | Shooting mode (□□74)                               | 10 | Image quality (□□209)                                 |
| 2 | Flash mode (□□122)                                 | 11 | Image size (□□212)                                    |
| 3 | Focus mode (□□132, □□140)                          | 12 | Easy panorama (□□109)                                 |
| 4 | Zoom (□□133, □□152)                                | 13 | Long exposure NR (when [Off] is set) (□□239)          |
| 5 | Focal length (in 35mm [135] format) (□□152, □□243) | 14 | Noise reduction filter (□□239)                        |
| 6 | Focus indicator (□□58)                             | 15 | Wind noise reduction (during movie recording) (□□252) |
| 7 | Digital zoom magnification (□□152)                 | 16 | Vibration reduction (□□283)                           |
| 8 | Movie options (normal speed movies) (□□247)        |    | Electronic VR (□□252)                                 |
| 9 | Movie options (HS movies) (□□248)                  |    |   |

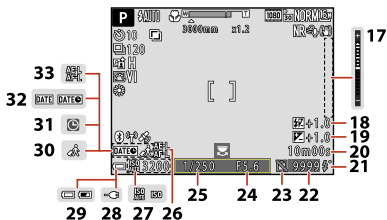

- |    |  |    |  |
|----|--|----|--|
| 17 | Exposure indicator (☐81)                                 | 26 | Auto exposure (AE)/Autofocus (AF) lock (still image) (☐138, ☐287)            |
| 18 | Flash exposure compensation (☐238)                       | 27 | ISO sensitivity (☐229)   |
| 19 | Exposure compensation value (☐144)                       | 28 | AC adapter connection  |
| 20 | Remaining movie recording time (☐175, ☐178)              | 29 | Battery level (☐58)  |
| 21 | Flash-ready indicator (☐123)                             | 30 | Travel destination (☐274)  |
| 22 | Number of exposures remaining (still images) (☐58, ☐211) | 31 | "Date not set" (☐274, ☐334)  |
| 23 | Enable release (when no memory card is inserted) (☐276)  | 32 | Date stamp (☐281)  |
| 24 | F-number (☐77)   | 33 | Auto exposure (AE)/Autofocus (AF) lock (during movie recording) (☐177, ☐287) |
| 25 | Shutter speed (☐77)                                      |    |  |

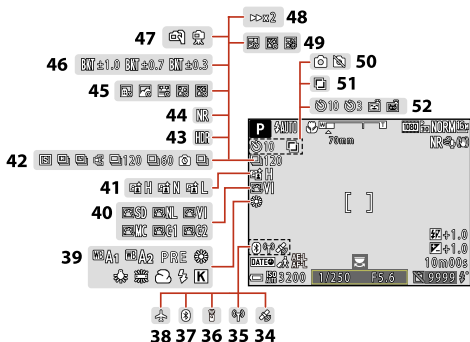

- 34 Location data (☐296)
- 35 Wi-Fi communication (☐270, ☐307)
- 36 Bluetooth remote control connected (☐329)
- 37 Bluetooth communication (☐270, ☐303)
- 38 Airplane mode (☐270)
- 39 White balance (☐219)
- 40 COOLPIX Picture Control (☐213)
- 41 Active D-Lighting (☐240)
- 42 Continuous shooting mode (☐96, ☐100, ☐113, ☐224)

- 43 Backlighting (HDR) (☐108)
- 44 Noise reduction burst/single shot (☐99, ☐105)
- 45 Time-lapse movie (☐187)
- 46 Exposure bracketing (☐231)
- 47 Hand-held/tripod (☐101, ☐103)
- 48 Playback speed (☐190)
- 49 Multiple exp. Lighten (☐116)
- 50 Still image capture (during movie recording) (☐181)
- 51 Multiple exposure (☐241)
- 52 Self-timer (☐127)  
Smile timer (☐130)  
Pet portrait auto release (☐113)

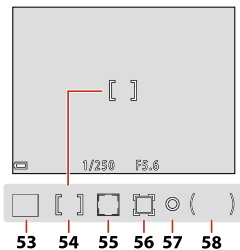

**53** Focus area (target finding AF)  
(☐134, ☐232)

**54** Focus area (center, manual)  
(☐96, ☐138, ☐232)

**55** Focus area (face detection, pet detection) (☐113, ☐130, ☐136, ☐232)

**56** Focus area (subject tracking)  
(☐232, ☐236)

**57** Spot metering area (☐223)

**58** Center-weighted area (☐223)

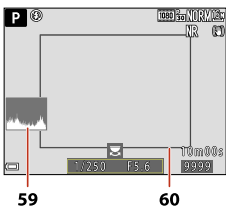

**59** Histogram (☐277)

**60** Framing border ([**Bird-watching**] or [**Moon**] mode, or snap-back zoom) (☐96, ☐97, ☐154)

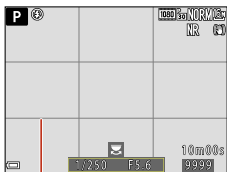

61

61 Framing grid (☐277)

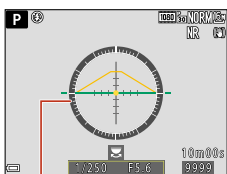

62

62 Virtual horizon (☐277, ☐280)

# Playback screen

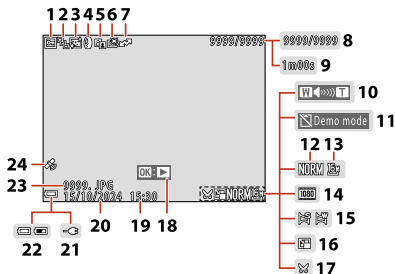

1	Protect (☐264)	14	Movie options (☐247)
2	Sequence display (when [Individual pictures] is selected) (☐269)	15	Easy panorama (☐109)
3	Skin softening (☐259)	16	Small picture (☐268)
4	Filter effects (☐260)	17	Cropped (☐164)
5	D-Lighting (☐258)	18	Easy panorama playback guide (☐171)
6	Quick retouch (☐257)		Sequence playback guide (☐168)
7	Marked for upload (☐256)		Movie playback guide (☐175)
8	Current image number/total number of images	19	Time of recording
9	Movie length or elapsed playback time	20	Date of recording
10	Volume (☐192)	21	AC adapter connection
11	Enable release (when no memory card is inserted) (☐276)	22	Battery level (☐58)
12	Image quality (☐209)	23	File name (☐365)
13	Image size (☐212)	24	Recorded location data (☐296)

## **Tone level information**

You can check for loss of contrast detail in highlights and shadows from the histogram that is displayed, or the flashing display for each tone

level. These provide guidelines when adjusting the image brightness with functions such as exposure compensation.

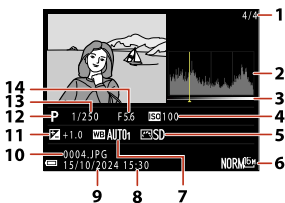

1 Current image number/total number of images

2 Histogram

- A histogram is a graph showing the distribution of tones in the image. The horizontal axis corresponds to pixel brightness, with dark tones to the left and bright tones to the right. The vertical axis shows the number of pixels.

3 Tone level

- The tone level indicates the brightness level. When the tone level to check is selected using the multi selector ◀▶ or rotating it, the area of the image that corresponds to the selected tone level flashes.

4 ISO sensitivity (☐229)

5 COOLPIX Picture Control (☐213)

6 Image quality/Image size (☐209, ☐212)

7 White balance (☐219)

8 Time of recording (☐55, ☐274)

9 Date of recording (☐55, ☐274)

10 File name (☐365)

11 Exposure compensation value (☐144)

12 Shooting mode (☐74)

13 Shutter speed (☐77)

14 F-number (☐77)

# Switching the information displayed on the screen (DISP button)

To switch the information displayed on the screen during shooting or playback, press the **DISP** (display) button. You can also hide the information.

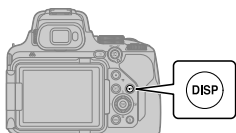

## For shooting

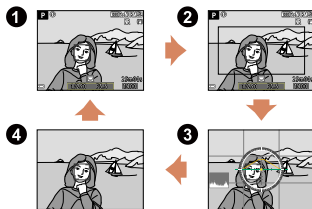

❶: Show information<sup>1</sup>

❷: Movie frame<sup>1</sup>

Display the range of a movie in a frame.

❸: Display only the framing grid, histogram, and virtual horizon<sup>2</sup>

❹: Hide information

1 The framing grid, histogram, and virtual horizon are displayed depending on the settings in the setup menu → **[Monitor settings]** (□277).

- 2 If the framing grid, histogram, and virtual horizon are not set to be displayed in the setup menu → **[Monitor settings]** (☐277), this screen will not be displayed.



## Power-on lamp (charge lamp)

The power-on lamp (charge lamp) turns on or flashes in the following situations.

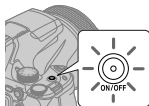

Status	Meaning
<b>On</b>	<ul style="list-style-type: none"><li>• Turns on immediately after the camera is turned on. When the monitor is on, the power-on lamp turns off.</li><li>• The camera is connected to a computer with the USB cable (when the setup menu → <b>[Charge by computer]</b> → <b>[Off]</b> is set, or when charging is complete with <b>[Auto]</b>).</li><li>• The camera is connected to an HDMI-compatible device with the HDMI cable.</li><li>• The electronic viewfinder is being used.</li><li>• <b>[Multiple exp. Lighten]</b> (□116) scene mode is set to <b>[Star trails]</b> and shooting is in progress.</li></ul>
<b>Flashing</b>	<ul style="list-style-type: none"><li>• The camera is in standby mode because it has not been operated for about one minute (□64).</li><li>• The battery is charging (□51, □292).</li><li>• <b>[Intvl timer shooting]</b> is in progress (□228).</li><li>• Movie recording is in progress while the camera is connected to an HDMI-compatible device (when the setup menu → <b>[HDMI]</b> (□290) → <b>[Clean HDMI output]</b> → <b>[On]</b> is set).</li></ul>

Status	Meaning
<b>Flashing quickly</b>	<ul style="list-style-type: none"> <li>· The battery cannot be charged (□51, □293, □359).</li> <li>· If [<b>Battery exhausted.</b>] is displayed on the screen, charge or replace the battery.</li> <li>· The inside of the camera or the battery has become hot. The camera turns off automatically. Wait until the camera or battery temperature has cooled before resuming use.</li> </ul>

# Getting started

## Attaching the strap

Attach the strap to the left and right side of the camera.

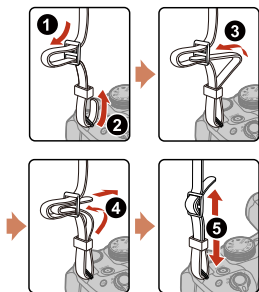

## Attaching/removing the lens cap and lens hood

- When you are not shooting images, attach the lens cap to protect the lens.
- When the lens hood is attached, it cuts out light which adversely affects the image, and also helps protect the camera. Do not use the lens hood when shooting with a flash or when the AF-assist illuminator is necessary for shooting.
- Turn off the camera before attaching/removing the lens hood.

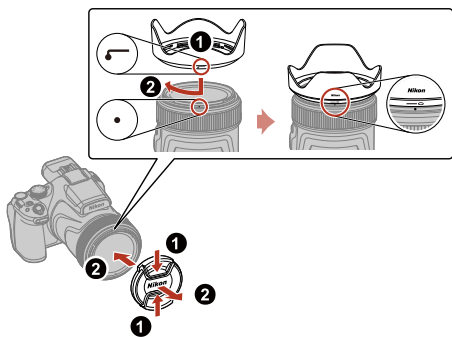

The lens hood can be reversed and mounted on the lens when not in use.

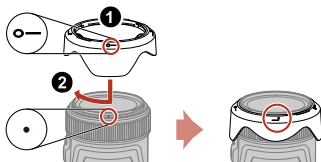

# Inserting the battery and memory card

## 1 Open the battery-chamber/memory card slot cover.

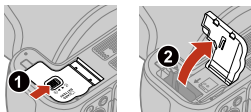

## 2 Insert the battery and memory card.

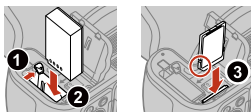

- With the battery's positive and negative terminals oriented correctly, move the orange battery latch (1), and fully insert the battery (2).
- Slide the memory card in until it clicks into place (3).
- Be careful not to insert the battery or memory card upside-down or backward, as this could cause a malfunction.
- If the write-protect switch of the memory card is locked, you cannot shoot, delete images, or format the memory card.

## 3 Close the battery-chamber/memory card slot cover.



---

## ✔ Formatting a memory card

The first time you insert a memory card that has been used in another device into this camera, make sure to format it with this camera.

- **Note that formatting a memory card permanently deletes all images and other data on the memory card.**

Be sure to make copies of any images you wish to keep before formatting the memory card.

- Insert the memory card into the camera, press the **MENU** button, and select the setup menu → **[Format card]**.
- 

## Removing the battery or memory card

Turn the camera off and make sure that the power-on lamp and screen have turned off, and then open the battery-chamber/memory card slot cover.

- Move the orange battery latch to eject the battery.
- Gently push the memory card into the camera to partially eject the memory card.
- Be careful when handling the camera, battery, and memory card immediately after using the camera, as they may be hot.

## Memory cards that can be used

The camera supports SD, SDHC, and SDXC memory cards.



- The camera supports UHS-I.
- Memory cards with an SD Speed Class rating of 6 (Video Speed Class V6) or faster are recommended for recording movies. When **[Movie options]** is set to **[2160/30p]** (4K UHD) or **[2160/25p]** (4K UHD), memory cards with a UHS Speed Class rating of 3 (Video Speed Class V30) or faster are recommended. Movie recording may stop unexpectedly when a memory card with a lower Speed Class rating is used.

- If you use a card reader, make sure that it is compatible with your memory card.
- Contact the manufacturer for information on features, operation, and limitations on use.

## Charging the battery

Charge the supplied EN-EL20a Rechargeable Li-ion Battery before use. With the battery inserted in the camera, connect the camera to the optional EH-8P AC Adapter using the separately sold UC-E25 USB Cable (featuring Type C connectors at both ends) to charge the battery.

- The EH-8P AC Adapter cannot be connected using the supplied USB cable.

---

### ✔ Notes about using the battery

Read and follow the warnings and cautions in “For your safety” (□16) and under “The battery” (□359) in “Caring for the product”.

---

#### **1** Insert the EN-EL20a into the camera.

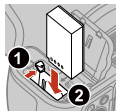

## 2 Connect the separately sold UC-E25 USB Cable (featuring Type C connectors at both ends) to the camera, and then connect the optional EH-8P AC Adapter (❶).

Plug the AC adapter into a household power outlet. Keep the plug straight during insertion and removal.

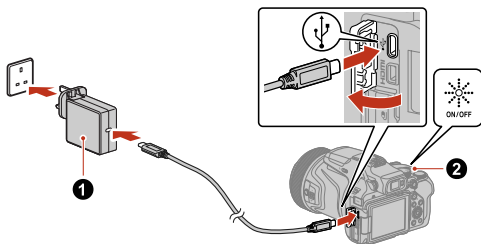

- The power-on lamp (charge lamp) (❷) flashes while the battery is charging. When charging is complete, the power-on lamp (charge lamp) turns off.
- An exhausted battery will fully charge in about 3 hours.
- When charging is complete, disconnect the USB cable. Be sure to keep the connectors straight when disconnecting them.
- The shape of the plug varies with the country or region of purchase.

---

## ✔ Notes about charging the battery

- The battery cannot be charged when the power-on lamp (charge lamp) quickly flashes, possibly due to one of the reasons described below.
  - The ambient temperature is not suited to charging.
  - The USB cable or AC adapter is not properly connected.
  - The battery is damaged.
- The camera can be operated while the battery is charging, but the charging time increases. The power-on lamp (charge lamp) turns off while the camera is being operated.

---

### **Tip: Charging the camera battery with the EH-73P Charging AC Adapter (available separately)**

The camera battery can also be charged with the EH-73P Charging AC Adapter (available separately). Connect the supplied USB cable to the camera's USB connector, and then insert the plug into an electrical outlet. Keep the plug straight during insertion and removal.

### **Tip: Charging with third-party AC adapters that are equipped with USB Type C connectors and are compliant with USB PD (power delivery) standards**

- The camera battery can also be charged with third-party AC adapters. Use an AC adapter that complies with USB PD (power delivery) standards and is equipped with USB Type C connectors.
- Use an AC adapter that supports output of 15 W (5 V/3 A) or more.
- Use a USB cable that is Type C on both ends to connect to the camera.
- We do not guarantee that all third-party AC adapters and USB cables are able to charge the camera battery.

### **Tip: Connecting to a computer to charge the camera battery**

You can also connect the camera to a computer using the supplied USB cable to charge the battery. For more information, see "Charge by computer" (□292).

---

## Opening the monitor

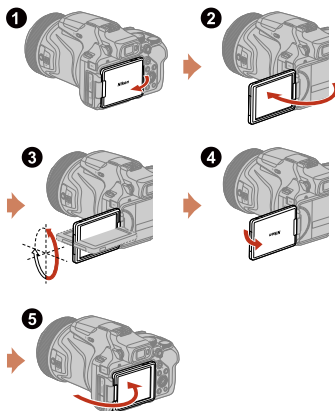

- You can adjust the direction and angle of the monitor. For normal shooting, fold the monitor against the back of the camera, facing out (**5**).
- When you are not using or carrying the camera, fold the monitor against the camera body with the screen facing in (**1**).

### ✓ Notes about the monitor

- The monitor's adjustable range may be limited when a cable or accessories are attached to the camera.
- When moving the monitor, do not apply excessive force and move slowly within the monitor's adjustable range so that the connection will not be damaged.

# Camera setup

When the camera is turned on for the first time, screens to set the display language and camera clock are displayed.

Use the multi selector (1) and  $\text{OK}$  (apply selection) button (2) to select and adjust settings.

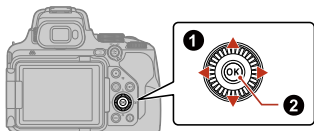

## 1 Press the power switch to turn on the camera.

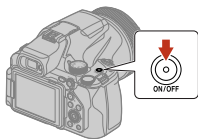

## 2 Press $\blacktriangle$ / $\blacktriangledown$ on the multi selector to highlight a language and press the $\text{OK}$ button to select.

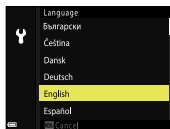

- The displayed languages vary depending on the country or region.

---

### 3 Select [Yes] and press the **OK** button.

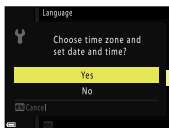

---

### 4 Highlight your home time zone and press the **OK** button.

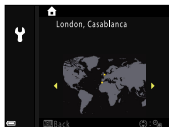

- To turn daylight saving time on, press ▲; ☀ will be displayed above the map. Press ▼ to turn daylight saving time off.

---

### 5 Press ▲▼ to select a date format and press the **OK** button.

---

### 6 Set the date and time.

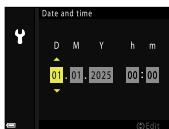

- Press ◀▶ to highlight items and ▲▼ to change them.
- Select the minute field and press the **OK** button to confirm the setting.

---

**7** When prompted, press ▲▼ to highlight [Yes] and press the **OK** button.

- Setup is complete and the camera switches to the shooting screen.

---

**Tip: Setting the language**

The language can be set at any time in the **Y** setup menu → [Language].

**Tip: To change the time zone and date setting**



Set in the **Y** setup menu → [Time zone and date].

In [Time zone and date] → [Time zone], the time is one hour earlier when daylight saving time is on, and goes back one hour when it is off.

---

# Basic operations of shooting and playback

## Shooting still images

 (auto) mode is used here as an example.  (auto) mode enables you to perform general shooting in a variety of shooting conditions.

- 1 Rotate the mode dial to .**

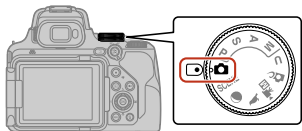

---

## 2 Check the battery level and number of exposures remaining on the shooting screen.



1

2

- Battery level (1)

- ☐: The battery level is high.

- 🔋: The battery level is low.

- Number of exposures remaining (2)

- Press the **DISP** (display) button to switch the information displayed on the screen each time.

---

## 3 Hold the camera steady.

- Keep fingers and other objects away from the lens, flash, AF-assist illuminator, eye sensor, microphone, and speaker.

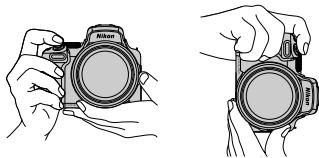

## 4 Frame the picture.

- Move the zoom control or the side zoom control to change the zoom lens position.
- To zoom in, move toward **T** (1).
- To zoom out, move toward **W** (2).
- If you lose sight of the subject while shooting with the lens in telephoto position, press the  (snap-back zoom) button (3) to temporarily widen the visible area so that you can frame the subject more easily.

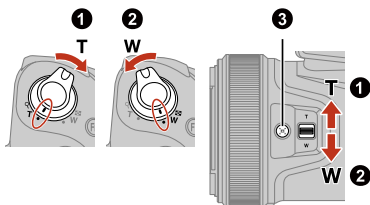

- See “Using a tripod” (p.63) when using a tripod.

---

## 5 Press the shutter-release button halfway.

- To press the shutter-release button “halfway” means to press and hold the button at the point where you feel a slight resistance.

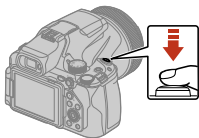

- When the subject is in focus, the focus area or focus indicator is displayed in green.



- When you are using digital zoom, the camera focuses in the center of the frame and the focus area is not displayed.
- If the focus area or focus indicator flashes, the camera is unable to focus. Modify the composition and try pressing the shutter-release button halfway again.

---

## 6 Without lifting your finger, press the shutter-release button all the way down.



---

### ✔ Notes about saving images or movies

The indicator showing the number of exposures remaining or the indicator showing the remaining recording time flashes, or [**Please wait for the camera to finish recording.**] is displayed while images or movies are being saved. **Do not open the battery-chamber/memory card slot cover or remove the battery or memory card while an indicator is flashing.** Doing this could result in loss of data, or in damage to the camera or the memory card.

---

---

## Tip: Using a tripod

- We recommend using a tripod to stabilize the camera in the following situations:
  - When shooting in dim lighting and the flash is  (off)
  - When the zoom is at a telephoto position
- When using a tripod to stabilize the camera during shooting, select the setup menu → **[Vibration reduction]** → **[Off]** to prevent potential errors caused by this function.
- After attaching the camera to a tripod, make sure that the camera does not fall over when zooming the lens in or out.  
Extend one leg of the tripod toward the subject and the other two legs toward you at an equal distance.
  - When zoom is at wide-angle position

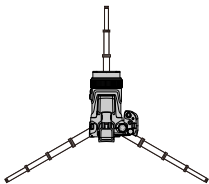

- When zoom is at telephoto position

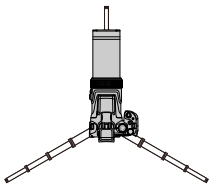

- The camera may move slightly when operated, even if it is attached to a tripod, which may interfere with the autofocus. Wait a few seconds after operating the camera, and then slowly press the shutter-release button.

### Tip: The auto off function

- When no operations are performed for about one minute, the screen turns off, the camera enters standby mode, and then the power-on lamp flashes. The camera turns off after remaining in standby mode for about three minutes.
  - To turn the screen back on while the camera is in standby mode, perform an operation such as pressing the power switch or shutter-release button.
- 

## Using the built-in flash

In situations where a flash is needed, such as in dark locations or when the subject is backlit, move the ⚡ (flash pop-up) control to raise the built-in flash.

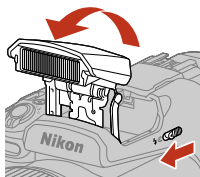

- When not using the built-in flash, gently push to lower the built-in flash until it clicks shut.

## Recording movies

Display the shooting screen and press the ● (▶🎬 movie-record) button to start recording a movie. Press the ● (▶🎬) button again to end recording.

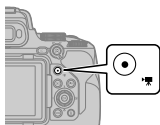

- When you rotate the mode dial to 🎬 (Movie manual), you can set the shutter speed and f-number for movie recording.
- For information about recording and playing back movies, see “Movies” (📖175).

## Switching between the monitor and viewfinder

It is recommended that you use the viewfinder (❶) when bright conditions make it difficult to see the monitor, such as when outdoors in sunlight.

- When you bring your face close to the viewfinder, the eye sensor responds to it and the viewfinder turns on, and the monitor turns off (default setting).
- You can also press the  (monitor) button to switch the display between the monitor and viewfinder.

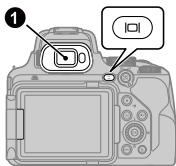

### ■ Diopter adjustment of the viewfinder

When the display in the viewfinder is difficult to see, adjust by rotating the diopter adjustment control (❶) while looking through the viewfinder.

- Take care not to scratch your eye with your fingertips or nails.



1

# Playing back images

- 1 Press the  (playback) button to enter full-frame playback mode.

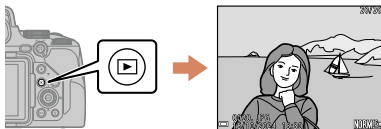

- If you press and hold down the  button while the camera is turned off, the camera turns on in playback mode.

## 2 Use the multi selector to select an image to display.



- Use the multi selector **▲◀** to display the previous image, or **▼▶** to display the next image.
- Press and hold down **▲▼◀▶** to scroll through the images quickly.
- Images can also be selected by rotating the multi selector.
- Press the **DISP** (display) button to switch the information displayed on the screen each time.
- To play back a recorded movie, press the **Ⓞ** button.
- To return to shooting mode, press the **▶** button or shutter-release button.
- Move the zoom control toward **T** (🔍) in full-frame playback mode to zoom in on an image (☞162).
- In full-frame playback mode, move the zoom control toward **W** (🖼️) to switch to thumbnail playback mode and display multiple images on the screen (☞166).

### ■ Other playback methods

- Easy panorama (☞171)
- Sequence images (☞168)
- Movies (☞175, ☞192)

# Deleting images

- 1 In playback mode, press the  (delete) button to delete the image currently displayed on the screen.

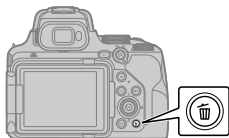

- 2 Use the multi selector   to select the desired deletion method and press the  button.

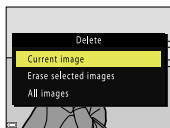

- If you selected [**Current image**] or [**All images**], proceed to step 6.
- To exit without deleting, press the MENU button.

- 
- 3 Use the multi selector ◀▶ or rotate it to select the image that you want to delete.**

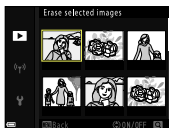

- Move the zoom control toward **T** (📐) to switch to full-frame playback, or **W** (📄) to switch to thumbnail playback.

- 
- 4 Use ▲▼ to show or hide 🗑️.**



- Show 🗑️ under images that you want to delete. Repeat steps 3 and 4 to select additional images.

- 
- 5 Press the Ⓞ button to apply the image selection.**

---

## 6 When the confirmation dialog is displayed, select [Yes] and press the **OK** button.



- Deleted images cannot be recovered.
- The message in the confirmation dialog varies depending on the selected deletion method.

---

### ✔ Notes about deleting images simultaneously saved in RAW and JPEG

When using this camera to delete images captured using [RAW + Fine] or [RAW + Normal] in the [Image quality] setting, both of the simultaneously saved RAW and JPEG images are deleted. You cannot delete only one format.

### ✔ Deleting images captured continuously (sequence)

- Images captured continuously are saved as a sequence, and only the first image of the sequence (the key picture) is displayed in playback mode (default setting).



- If you press the **Trash** button while a key picture is displayed for a sequence of images, all images in the sequence are deleted.
  - To delete individual images in a sequence, press the **OK** button to display them one at a time and press the **Trash** button.
-

---

**Tip: Deleting the image captured while in shooting mode**

When using shooting mode, press the  button to delete the last image that was saved.



---

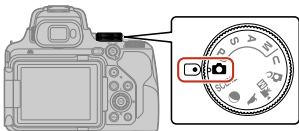

# Shooting features

## Selecting a shooting mode (mode dial)

You can rotate the mode dial to align the desired shooting mode with the indicator mark on the camera body.

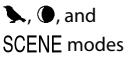

Shooting mode	Description
 (Auto) mode	Select this mode to perform general shooting in a variety of shooting conditions.
<b>P, S, A, and M</b> modes	Select these modes for greater control over shutter speed and f-number.
<b>U</b> (User settings) mode	The frequently used settings in <b>P, S, A, and M</b> modes can be saved. To shoot with the saved settings, rotate the mode dial to <b>U</b> .
 (Creative) mode	Apply effects to images during shooting.
 (Movie manual) mode	You can record movies with the exposure mode set to aperture-priority auto or manual.

Shooting mode	Description
 <p>Bird, Moon, and SCENE modes</p>	<p>Select any one of scene modes based on the shooting conditions, and you can take pictures with the appropriate settings for those conditions.</p> <ul style="list-style-type: none"> <li>•  (bird-watching): Use this mode when capturing images of birds in a telephoto position.</li> <li>•  (moon): Use this mode when capturing images of the moon in a telephoto position.</li> <li>• SCENE (scene): Press the MENU button and select a scene mode.</li> </ul>

## Auto mode (standard shooting)

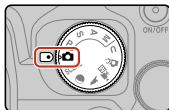

Select this mode to perform general shooting in a variety of shooting conditions.

- The camera detects the main subject and focuses on it (target finding AF). If a human face is detected, the camera automatically sets focus priority on it (□132).

### ■ Functions available in (auto) mode

- Flash mode (□122)
- Self-timer (□127)
- Smile timer (□130)
- Focus mode (□132)
- Exposure compensation (□144)
- Shooting menu (□209)

## P, S, A, and M modes

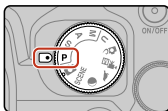

In **P**, **S**, **A**, and **M** modes, you can set exposure (combination of shutter speed and f-number) according to the shooting conditions. Also, you can achieve greater control when shooting images by setting the shooting menu options.

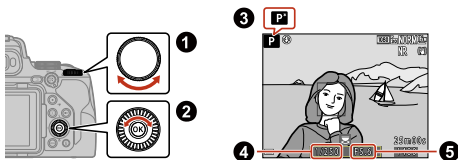

Shooting mode	Description
<b>P Programmed auto</b>	<p>You can let the camera adjust the shutter speed (4) and f-number (5).</p> <ul style="list-style-type: none"><li>• The combination of shutter speed and f-number can be changed by rotating the command dial (1) (flexible program). While the flexible program is in effect, <b>P</b> (flexible program mark) is displayed on the upper left of the screen (3).</li><li>• To cancel the flexible program, rotate the command dial in the opposite direction than when you set it until <b>P</b> is no longer displayed. It is also canceled if you change the shooting mode or turn off the camera.</li></ul>

Shooting mode	Description
<b>S Shutter-priority auto</b>	Rotate the command dial (1) to set the shutter speed (4). The camera automatically determines the f-number (5).
<b>A Aperture-priority auto</b>	Rotate the multi selector (2) to set the f-number (5). The camera automatically determines the shutter speed (4).
<b>M Manual</b>	<p>Set both the shutter speed (4) and f-number (5).            Rotate the command dial (1) to set the shutter speed.            Rotate the multi selector (2) to set the f-number (□81).</p> <ul style="list-style-type: none"> <li>You can use the Bulb setting or Time setting to capture images with a long time-exposure.</li> </ul>

- The allocations of the controls for setting the exposure can be changed in the setup menu → [Toggle Av/Tv selection] (□297).

## Tips for setting exposure

The sense of dynamism and amount of background defocus in subjects vary by changing the combinations of shutter speed and f-number even if the exposure is the same.

### **Effect of the shutter speed**

The camera can make a fast-moving subject appear static at a fast shutter speed, or highlight the motion of a moving subject at a slow shutter speed.

- Faster  
1/1000 s



- Slower  
1/30 s



### **Effect of the f-number**

The camera can blur the subject's background intentionally, or bring the subject, foreground, and background into focus.

- Small f-number (larger aperture)

f/2.8



- Large f-number (smaller aperture)

f/8



---

### Tip: Shutter speed and f-number

- The control range of the shutter speed differs depending on the zoom position, f-number, or ISO sensitivity setting.
- The f-number of this camera also changes depending on the zoom position.
- When zooming is performed after the exposure is set, exposure combinations or the f-number may be changed.
- Large apertures (expressed by small f-numbers) let more light into the camera, and small apertures (large f-numbers) let less light. The smallest f-number represents the largest aperture, and the largest f-number represents the smallest aperture.
- The closer the lens is to the telephoto zoom position, the smaller the aperture range becomes. The f-number is fixed at f/8.0 when the zoom is in a telephoto position beyond the focal length equivalent to that of a 2800 mm lens (in 35mm [135] format).

### Tip: Setting exposure when recording movies

When recording movies in **P**, **S**, **A**, **M**, or **U**, the shutter speed and f-number that you set are not applied. When the mode dial is rotated to  (Movie manual), you can set the exposure for movie recording.

---

### ✔ Notes about setting exposure

When the subject is too dark or too bright, it may not be possible to obtain the appropriate exposure. In such cases, the shutter speed indicator or f-number indicator flashes when the shutter-release button is pressed halfway (except when the **M** mode is used). Change the shutter speed setting or f-number.

---

### ■ Exposure indicator (when in M mode)

The degree of deviation between the adjusted exposure value and the optimal exposure value measured by the camera is displayed in the exposure indicator on the screen. The degree of deviation in the

exposure indicator is displayed in terms of EV (-2 to +2 EV in increments of 1/3 EV).



---

### ✓ Notes about ISO sensitivity

When [ISO sensitivity] (☐229) is set to [Auto] (default setting) or [Fixed range auto], the ISO sensitivity in **M** mode is fixed at ISO 100.

---

### ■ Functions available in P, S, A, and M modes

- Flash mode (☐122)
- Self-timer (☐127)
- Smile timer (☐130)
- Focus mode (☐132)
- Exposure compensation (☐144)
- Shooting menu (☐209, ☐213)
- Functions that can be set using the Fn button (☐149)

---

#### Tip: Focus area

The focus area for autofocus varies depending on the setting in the shooting menu → [AF area mode] (☐232). When set to [Target finding AF] (default setting), the camera detects the main subject and focuses on it. If a human face is detected, the camera automatically sets focus priority on it.

---

## The control range of the shutter speed (P, S, A, and M modes)

The control range of the shutter speed differs depending on the zoom position, f-number, or ISO sensitivity setting. Additionally, the control range changes in the following continuous shooting settings.

Setting		Control range (second)
ISO sensitivity <sup>1</sup>	Auto2, Fixed range auto2	1/4000 <sup>3</sup> , 4–1 s ( <b>P</b> , <b>S</b> , and <b>A</b> modes) 1/4000 <sup>3</sup> , 4–30 s ( <b>M</b> mode) <sup>5</sup>
	ISO 100	1/4000 <sup>3</sup> , 4–8 s ( <b>P</b> , <b>S</b> , and <b>A</b> modes) 1/4000 <sup>3</sup> , 4–30 s ( <b>M</b> mode) <sup>5</sup>
	ISO 200	1/4000 <sup>3</sup> , 4–4 s ( <b>P</b> , <b>S</b> , and <b>A</b> modes) 1/4000 <sup>3</sup> , 4–8 s ( <b>M</b> mode)
	ISO 400	1/4000 <sup>3</sup> , 4–4 s
	ISO 800	1/4000 <sup>3</sup> , 4–2 s
	ISO 1600	1/4000 <sup>3</sup> , 4–1 s
	ISO 3200	1/4000 <sup>3</sup> , 4–1/2 s
	ISO 6400	1/4000 <sup>3</sup> , 4–1/2 s
Continuous	Continuous H, Continuous L	1/4000 <sup>3</sup> , 4–1/30 s
	Pre-shooting cache, Continuous H: 120 fps	1/4000–1/125 s
	Continuous H: 60 fps	1/4000–1/60 s
	Intvl timer shooting	Same as when [ <b>Single</b> ] is set

- 1 The ISO sensitivity setting is restricted depending on the continuous shooting setting (□156).
- 2 In **M** mode, the ISO sensitivity is fixed at ISO 100.

- 3 The maximum shutter speed when the f-number is set to the largest value (smallest aperture) at the maximum wide-angle zoom position. The closer the zoom position is to telephoto, or the smaller the f-number (larger aperture) is, the slower the maximum shutter speed becomes.
- 4 The exposure may vary when capturing the same subject multiple times with a shutter speed faster than 1/2000 second.
- 5 Bulb setting and Time setting (□□85) are available.

## Shooting with the Bulb setting or Time setting (when in M mode)

Use the Bulb setting or Time setting to capture images with a long time-exposure, such as when taking pictures of fireworks, night landscapes, the night sky, or car light trails. The maximum exposure time for both the Bulb and Time setting is 60 seconds.

Option	Description
<b>Bulb</b>	The shutter remains open while the shutter-release button is pressed, and it closes when the button is released.
<b>Time</b>	The shutter opens when the shutter-release button is pressed all the way down, and it closes when the button is pressed all the way down again. <ul style="list-style-type: none"><li>• You can use the shutter-release button on the ML-L7 Remote Control (available separately) to shoot with the Time setting.</li></ul>

### 1 Stabilize the camera by using a tool such as a tripod.

- Select the setup menu → **[Vibration reduction]** → **[Off]**.
- See “Using a tripod” (□63) when using a tripod.

### 2 Rotate the mode dial to M.

- Set **[ISO sensitivity]** to **[Auto]**, **[Fixed range auto]**, or **[100]**.
- Set **[Continuous]** to **[Single]**.

---

### 3 Rotate the command dial to a slower speed until the shutter speed indicator displays [Bulb] or [Time].



---

### 4 Press the shutter-release button after setting the focus.

- Bulb: Hold down the shutter-release button until the desired exposure time elapses.
- Time: Press the shutter-release button all the way down again when the desired exposure time elapses.
- When the exposure time reaches 60 seconds, the shutter automatically closes and shooting ends.

---

#### ✓ Notes about shooting with the Bulb or Time setting

- The Bulb or Time setting cannot be used when [ISO sensitivity] is set to [200], [400], [800], [1600], [3200], or [6400].
- The Bulb or Time setting cannot be used when a setting other than [Single] is selected for [Continuous].

---

#### Tip: Long time-exposures

- It may take longer for the camera to save images if a slow shutter speed is used when shooting.
  - It is recommended that you use a sufficiently charged battery or the EH-5d AC Adapter and the EP-5C Power Connector (both available separately) to prevent the camera from turning off unexpectedly (□320).
-



### 3 Press the MENU (menu) button to display the shooting menu.

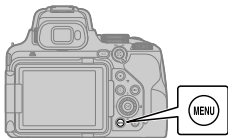

### 4 Use the multi selector ▲▼ to select [Save user settings], and press the OK button.

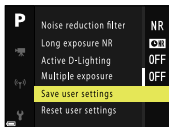

- The previous saved settings are overwritten by the current settings as the **U** mode.

## Resetting U (user settings) mode

If the shooting menu → [Reset user settings] is selected, the settings that are saved in the user settings are restored to their default values.

### ✓ Notes about the clock battery

If the internal clock battery is exhausted, the settings saved in **U** will be reset. Writing down any important setting is recommended.

## List of setting options that can be saved in U mode

### General settings

- Shooting modes **P**, **S**, **A**, and **M** (□77)

- Zoom position (☐☐152)
- Flash mode (☐☐122)
- Self-timer (☐☐127)
- Focus mode (☐☐132)
- Exposure compensation (☐☐144)
- Fn button (☐☐149)

### **Manual focus settings**

- Distance to a subject, magnification rate, and peaking level (☐☐140)

### **Display settings**

- Monitor and viewfinder display (☐☐66)
- Displayed information (☐☐33)

### **Shooting menu**

- Image quality (☐☐209)
- Image size (☐☐212)
- Picture Control (☐☐213)
- Custom Picture Control (☐☐217)
- White balance (☐☐219)
- Metering (☐☐223)
- Continuous (☐☐224)
- ISO sensitivity (☐☐229)
- Exposure bracketing (☐☐231)
- AF area mode (☐☐232)
- Autofocus mode (☐☐237)
- Flash exp. comp. (☐☐238)
- Noise reduction filter (☐☐239)
- Long exposure NR (☐☐239)
- Active D-Lighting (☐☐240)
- Multiple exposure (☐☐241)
- Zoom memory (☐☐243)
- Startup zoom position (☐☐245)
- M exposure preview (☐☐245)

### **Setup menu**

- Monitor settings (📖277)

# Creative mode (applying effects when shooting)

Apply effects to images during shooting.

- Five effect groups are available: [Light] (default setting), [Depth], [Memories], [Classic], and [Noir].

## 1 Rotate the mode dial to .

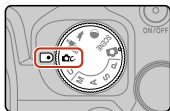

## 2 Press the button.

- The effect selection screen is displayed.

## 3 Use the multi selector to select an effect (1).



- The effect group (2) can be changed by rotating the command dial.
- To exit without saving the selection, press .

---

## 4 To adjust the effect, press ▼.



- If you do not want to adjust the effect, press the **OK** button to proceed to step 7.

---

## 5 Use ◀▶ to highlight the desired option and then press ▼.

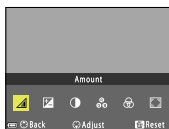

- Select **[Amount]**, **[Exposure compensation]**, **[Contrast]**, **[Hue]**, **[Saturation]**, **[Filter]**, or **[Peripheral illumination]**. The options that can be selected vary depending on the group.

---

## 6 Use ◀▶ to adjust the effect level and press the **OK** button.



---

## 7 Press the shutter-release button or ● (▶ movie-record) button to shoot.

- When the camera detects the main subject, it focuses on the subject (☞134).

---

### **Tip: Selecting an effect group and effect**

You can also select an effect group and effect by pressing the MENU button when the screen in step 2 is displayed.

---

## ■ Functions available in creative mode



- Flash mode (☞122)
- Self-timer (☞127)
- Focus mode (☞132)
- Exposure compensation (☞144)
- Shooting menu (☞209)

# Scene mode (shooting suited to the shooting conditions)

Select any one of scene modes based on the shooting conditions, and you can take pictures with the appropriate settings for those conditions.

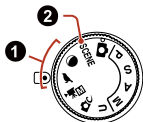
**1** Rotate the mode dial to  (bird-watching),  (moon), or SCENE.



- If you select  or  (1), the camera switches to the shooting screen (□96, □97).
- If you select SCENE (2), proceed to step 2.

**2** Press the MENU button.

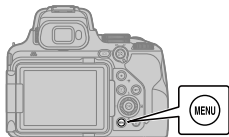

### 3 Use the multi selector to select a scene mode, and press the **OK** button.

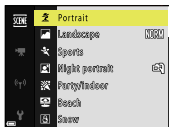

You can select from the following.

Portrait (□□99)

Landscape (□□99)

Sports (□□100)

Night portrait (□□101)

Party/indoor (□□102)

Beach (□□102)

Snow (□□102)

Sunset (□□102)

Dusk/dawn (□□103)

Night landscape (□□103)

Close-up (□□105)

Food (□□106)

Fireworks show (□□107)

Backlighting (□□108)

Easy panorama (□□109)

Pet portrait (□□113)

Soft (□□115)

Selective color (□□115)



Multiple exp. Lighten (□□116)

Time-lapse movie (□□187)

## Bird-watching

Use when shooting birds staying still at a distance.

### 1 Rotate the mode dial to .

- To capture images continuously, press the MENU button and select [Continuous].
  -  [Single] (default setting): One image is shot each time the shutter-release button is pressed.
  -  [Continuous]: While the shutter-release button is held all the way down, images are captured continuously. The camera can capture up to about 7 images continuously at a rate of about 7 fps.

### 2 Frame a bird in the framing border (1).



- At the wide-angle zoom position, the framing border is displayed to indicate the angle of view equivalent to that of a 500 mm lens (in 35mm [135] format) (default setting).
- You can change the angle of view for the framing border by pressing the MENU button and selecting [Focal length selection].

---

### 3 Press the button.

- The camera zooms in so that the area inside the framing border takes up the entire angle of view (focal length). Use the zoom control or side zoom control to adjust the angle of view/zoom position according to the shooting conditions.
- The camera focuses on the area in the center of the frame. If you press the MENU button, you can set [AF area mode] to [Center (spot)] (default setting), [Center (normal)], or [Center (wide)]. Set according to the size of the subject and the focus range.

---

### 4 Shoot.

---

#### Tip: The Bird-watching mode setting

The [Focal length selection], [Continuous], and [AF area mode] settings are saved in the camera's memory even after the camera is turned off.

---



## Moon

Use this mode to shoot the moon.

- Use of a tripod is recommended (63). When using a tripod to stabilize the camera during shooting, select the setup menu → [Vibration reduction] → [Off].

---

### 1 Rotate the mode dial to .

- The default setting of the self-timer is [3s] (3 seconds). To change the setting, press the multi selector .

---

## 2 Frame the moon in the framing border (1).

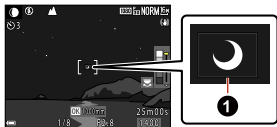

- At the wide-angle zoom position, the framing border is displayed to indicate the angle of view equivalent to that of a 1000 mm lens (in 35mm [135] format) (default setting).
- You can change the angle of view for the framing border by pressing the **MENU** button and selecting [**Focal length selection**].

---

## 3 Press the **OK** button.

- The camera zooms in so that the area inside the framing border takes up the entire angle of view (focal length). Use the zoom control or side zoom control to adjust the angle of view/zoom position according to the shooting conditions.
- You can adjust hue by using the command dial.
- Adjust the brightness with exposure compensation according to shooting conditions such as the waxing and waning of the moon and shooting requirements (□144).

---

## 4 Shoot.

- During autofocus, the camera focuses on the area in the center of the frame. The camera focuses at infinity.

---

### **Tip: The Moon mode setting**

The [**Focal length selection**] and hue settings are saved in the camera's memory even after the camera is turned off.



---

## Portrait

Rotate the mode dial to SCENE ➔ MENU button ➔  Portrait ➔  button

Use this mode to shoot portraits that emphasize human subjects.

## Landscape

Rotate the mode dial to SCENE ➔ MENU button ➔  Landscape ➔  button

Use this mode to shoot landscapes.

Option	Description
<b>Noise reduction burst</b>	This enables you to shoot a sharp landscape with a minimum of noise.
<b>Single shot (default setting)</b>	Saves images with emphasized outlines and contrast.

**1** Select [Noise reduction burst] or [Single shot].

## 2 Frame the subject and take a picture.

- The camera focuses on the area in the center of the frame. The position of the area cannot be moved.
- The camera focuses at infinity.
- For **[Noise reduction burst]**:
  - While the  icon on the shooting screen is displayed in green, press the shutter-release button all the way to capture a series of images which are combined into a single image and saved.
  - Once the shutter-release button is pressed all the way, hold the camera still until a still image is displayed. After taking a picture, do not turn the camera off before the screen switches to the shooting screen.
- For **[Single shot]**:
  - One image is captured when the shutter-release button is pressed all the way.

### ✓ Notes about [Noise reduction burst]

- The angle of view (i.e., the area visible in the frame) seen in the saved image is narrower than that seen on the shooting screen.
- Continuous shooting may not be possible in certain shooting conditions.

## Sports

Rotate the mode dial to SCENE ➡ MENU button ➡  Sports ➡  button

While the shutter-release button is held all the way down, the camera shoots images continuously.

- The camera can capture up to about 7 images continuously at a rate of about 7 fps.
- The camera focuses on the area in the center of the frame. The position of the area cannot be moved.



## ✔ Notes about [Sports]

- The frame rate for continuous shooting may become slow depending on the current image quality setting, image size setting, the memory card used, or shooting conditions (□49).
- Focus, exposure, and hue for the second and subsequent images are fixed at the values determined with the first image.

## Night portrait

Rotate the mode dial to SCENE ➔ MENU button ➔  Night portrait ➔  button

Use this mode to shoot evening and night portraits that include background scenery.

Option	Description
 <b>Hand-held (default setting)</b>	Compared to using  [Tripod], the camera sets a slightly faster shutter speed in accordance with the shooting conditions to prevent camera shake.
 <b>Tripod</b>	Select when shooting with the camera stabilized on a tool such as a tripod.

**1** Select  [Hand-held] or  [Tripod].

**2** Raise the built-in flash.



**3** Frame the subject and take a picture.

- One image is captured at a slow shutter speed.

## ✔ Notes about [Tripod]

Vibration reduction is disabled regardless of the setup menu ➔ [Vibration reduction] setting. See “Using a Tripod” (□63) when using a tripod.

## Party/indoor

Rotate the mode dial to SCENE ➔ MENU button ➔  Party/indoor ➔  button

Suitable for taking pictures at parties. Captures the effects of candlelight and other indoor background lighting.

- The camera focuses on the area in the center of the frame. The position of the area cannot be moved.
- To avoid the effects of camera shake, hold the camera steady. When using a tripod to stabilize the camera during shooting, select the setup menu ➔ **[Vibration reduction]** ➔ **[Off]**. See “Using a Tripod” (p63) when using a tripod.

## Beach

Rotate the mode dial to SCENE ➔ MENU button ➔  Beach ➔  button

Shoot bright and vivid seas, lakes, and beaches in daylight.

- The camera focuses on the area in the center of the frame. The position of the area cannot be moved.

## Snow

Rotate the mode dial to SCENE ➔ MENU button ➔  Snow ➔  button

Shoot bright and vivid snowscapes in daylight.

- The camera focuses on the area in the center of the frame. The position of the area cannot be moved.

## Sunset

Rotate the mode dial to SCENE ➔ MENU button ➔  Sunset ➔  button

Use this mode to shoot sunsets and sunrises.

- The camera focuses on the area in the center of the frame. The position of the area cannot be moved.
- The camera focuses at infinity.
- Use of a tripod is recommended (📖63). When using a tripod to stabilize the camera during shooting, select the setup menu → **[Vibration reduction]** → **[Off]**.

## Dusk/dawn

Rotate the mode dial to SCENE → MENU button → 🌆 Dusk/dawn →  button



Use this mode to shoot landscapes with little natural light, such as before dawn or after sunset.

- The camera focuses on the area in the center of the frame. The position of the area cannot be moved.
- The camera focuses at infinity.
- Use of a tripod is recommended (📖63). When using a tripod to stabilize the camera during shooting, select the setup menu → **[Vibration reduction]** → **[Off]**.

## Night landscape

Rotate the mode dial to SCENE → MENU button → 🌃 Night landscape →  button

Use this mode to shoot night landscapes.

Option	Description
 <b>Hand-held (default setting)</b>	Select when shooting with the camera in your hands instead of stabilizing it on a tool such as a tripod.
 <b>Tripod</b>	Select when shooting with the camera stabilized on a tool such as a tripod.

---

## 1 Select [Hand-held] or [Tripod].

---

## 2 Frame the subject and take a picture.

- The camera focuses on the area in the center of the frame. The position of the area cannot be moved.
- The camera focuses at infinity.
- For [**Hand-held**]:
  - While the  icon on the shooting screen is displayed in green, press the shutter-release button all the way to capture a series of images which are combined into a single image and saved.
  - Once the shutter-release button is pressed all the way, hold the camera still until a still image is displayed. After taking a picture, do not turn the camera off before the screen switches to the shooting screen.
- For [**Tripod**]:
  - One image is captured at a slow shutter speed when the shutter-release button is pressed all the way.

---

### ✔ Notes about [Hand-held]



- The angle of view (i.e., the area visible in the frame) seen in the saved image is narrower than that seen on the shooting screen.
- Continuous shooting may not be possible in certain shooting conditions.

### ✔ Notes about [Tripod]

Vibration reduction is disabled regardless of the setup menu → [**Vibration reduction**] setting. See “Using a Tripod” (☎63) when using a tripod.

---

## Close-up

Rotate the mode dial to SCENE ➔ MENU button ➔  Close-up ➔  button

Use when taking close-up pictures of small subjects such as flowers and insects.

Option	Description
<b>Noise reduction burst</b>	This enables you to shoot a sharp image with a minimum of noise.
<b>Single shot (default setting)</b>	Saves images with emphasized outlines and contrast.

**1** Select **[Noise reduction burst]** or **[Single shot]**.

## 2 Frame the subject and take a picture.

- The focus mode (□133) setting is changed to 📍 [Macro close-up] and the camera automatically zooms to the closest position at which it can focus.
- You can move the focus area. Press the Ⓞ button, use the multi selector ▲▼◀▶ or rotate it to move the focus area, and press the Ⓞ button to apply the setting.
- For [Noise reduction burst]:
  - While the 📍 icon on the shooting screen is displayed in green, press the shutter-release button all the way to capture a series of images which are combined into a single image and saved.
  - Once the shutter-release button is pressed all the way, hold the camera still until a still image is displayed. After taking a picture, do not turn the camera off before the screen switches to the shooting screen.
- For [Single shot]:

One image is captured when the shutter-release button is pressed all the way.

### ✓ Notes about [Noise reduction burst]

- If the subject moves or there is a significant camera shake during continuous shooting, the image may be distorted, overlapped, or blurred.
- The angle of view (i.e., the area visible in the frame) seen in the saved image is narrower than that seen on the shooting screen.
- Continuous shooting may not be possible in certain shooting conditions.

## Food

Rotate the mode dial to SCENE ➡ MENU button ➡ 🍴 Food ➡ Ⓞ button





Use this mode when taking pictures of food. You can also change the hue.

## 1 Adjust hue by using the command dial.





- The hue setting is saved in the camera's memory even after the camera is turned off.

## 2 Frame the subject and take a picture.

- The focus mode (□133) setting is changed to  **[Macro close-up]** and the camera automatically zooms to the closest position at which it can focus.
- You can move the focus area. Press the  button, use the multi selector  or rotate it to move the focus area, and press the  button to apply the setting.

## Fireworks show

Rotate the mode dial to **SCENE** → **MENU** button →  **Fireworks show** →  button



The camera captures fireworks at a slow shutter speed.

- The shutter speed is fixed at 4 seconds.
- It is recommended that you use manual focus (□140).
- Use of a tripod is recommended because the shutter speed is slow (□63). When using a tripod to stabilize the camera during shooting, select the setup menu → **[Vibration reduction]** → **[Off]**.

### ✓ Notes about [Fireworks show]

Exposure compensation cannot be used.

# Backlighting

Rotate the mode dial to SCENE → MENU button →  Backlighting →  button

Use this mode to shoot backlit subjects. Use when taking pictures with very bright and dark areas in the same frame.

Option	Description
<b>On</b>	High dynamic range (HDR) compositing is applied. Use when taking landscapes with very bright and dark areas in the same frame.
<b>Off (default setting)</b>	High dynamic range (HDR) compositing is not applied. The flash fires to prevent the subject from being hidden in shadow. Raise the built-in flash before shooting.

## 1 Select [On] or [Off] for high dynamic range (HDR) compositing.

## 2 Frame the subject and take a picture.

- The camera focuses on the area in the center of the frame. The position of the area cannot be moved.
- If [**On**] is set:
  - When there is a big difference between the bright and dark areas, the HDR icon on the shooting screen changes to green.
  - When the shutter-release button is pressed all the way, the camera shoots images continuously and saves two images (a non-HDR composite image and an HDR composite image in which the loss of details in highlights or shadows is minimized).
- If [**Off**] is set:

One image is captured when the shutter-release button is pressed all the way.

## ✔ Notes about HDR

- The angle of view (i.e., the area visible in the frame) seen in the saved image is narrower than that seen on the shooting screen.
- After taking a picture, do not turn the camera off before the screen switches to the shooting screen.
- Use of a tripod is recommended (☐63). When using a tripod to stabilize the camera during shooting, select the setup menu → **[Vibration reduction]** → **[Off]**.
- During hand-held shooting, after pressing the shutter-release button all the way, hold the camera steadily so that it does not shake until the still image is displayed.
- Under some shooting conditions, dark shadows may appear around bright subjects or bright areas may appear around dark subjects.
- If there is only enough memory to save one image, an image processed by D-Lighting at the time of shooting, in which dark areas of the image are corrected, is the only image saved.

## Easy panorama

Rotate the mode dial to SCENE → MENU button →  Easy panorama →  button

Use this mode to shoot panorama images that can be played back on the camera. The camera captures several images and composites them into a panorama image.

- 
- 1** Select  [Normal (180°)] or  [Wide (360°)] as the shooting range and press the  button.

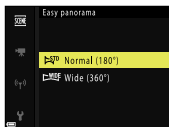





- 
- 2** Frame the first edge of the panorama scene, and then press the shutter-release button halfway to focus.

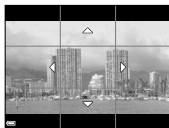

- The zoom position is fixed at wide-angle.
- The camera focuses on the area in the center of the frame. The position of the area cannot be moved.

- 
- 3** Press the shutter-release button all the way, and then remove your finger from the shutter-release button.



-     are displayed to indicate the direction of camera movement.

#### 4 Move the camera in one of the four directions until the guide indicator (1) reaches the end.



- When the camera detects which direction it is moving in, shooting begins.
- Shooting ends when the camera captures the specified shooting range.
- Focus and exposure are locked until shooting ends.

#### Example of camera movement

- Using your body as the axis of rotation, move the camera slowly in an arc, in the direction of the marking ( $\triangle \nabla \langle \rangle$ ).



- Shooting stops if the guide does not reach the edge within about 15 seconds (when  $\text{STD}$  [Normal (180°)] is selected) or within about 30 seconds (when  $\text{WIDE}$  [Wide (360°)] is selected) after shooting starts.

## ✓ Notes about easy panorama shooting

- The range of the image seen in the saved image is narrower than that seen on the screen at the time of shooting.
- If the camera is moved too quickly or shaken too much, or if the subject is too uniform (e.g. walls or darkness), an error may occur.
- If shooting is stopped before the camera reaches the half-way point in the panorama range, a panorama image is not saved.
- If more than half of the panorama range is captured but shooting ends before reaching the edge of the range, the range not captured is recorded and displayed in gray.

### Tip: Image size of easy panorama

There are four different image sizes (in pixels), as described below.

- When  [Normal (180°)] is set

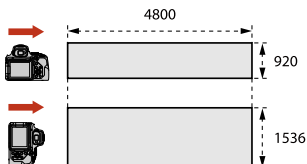

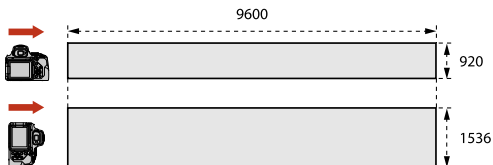

- When  [Wide (360°)] is set





### Tip: Easy panorama playback

See "Playback with easy panorama" (☞171) for information about easy panorama playback.

## Pet portrait

Rotate the mode dial to SCENE ➔ MENU button ➔  Pet portrait ➔  button

Use this mode when taking pictures of pets. When you point the camera at a dog or cat, the camera detects the face of a dog or cat and focuses on it. By default, the shutter is automatically released when the face of a dog or cat is detected (pet portrait auto release).

Option	Description
 <b>Single</b>	Whenever the face of a dog or cat is detected, the camera captures one image.
 <b>Continuous</b> <b>(default setting)</b>	Whenever the face of a dog or cat is detected, the camera captures three images continuously.



**1** Select  [Single] or  [Continuous].

**2** Point the camera at a dog or cat, and wait for the shutter to release automatically or press the shutter-release button.

---

## ✔ [Pet portrait auto release]

The following settings can be set when you press the multi selector ◀ (☺).

-  [Pet portrait auto release]: The camera automatically releases the shutter when it detects the face of a dog or cat.
  - Pet portrait auto release is set to [OFF] after five bursts have been taken.
  - You can also release the shutter by pressing the shutter-release button. When  [Continuous] is selected, images are captured continuously while the shutter-release button is held all the way down.
- [OFF]: The camera releases the shutter when the shutter-release button is pressed all the way down.
  - The camera focuses on the face of a dog, cat, or human when detected.
  - When  [Continuous] is selected, images are captured continuously while the shutter-release button is held all the way down.

## ✔ Focus area

- When the camera detects a face, the face is displayed inside a yellow border. When the camera acquires focus on a face displayed inside a double border (focus area), the double border changes to green. If no faces are detected, the camera focuses on the area in the center of the frame.



- Under some shooting conditions, the face of a dog, cat, or human may not be detected and other subjects may be displayed inside a border.
-



## Soft

Rotate the mode dial to SCENE ➔ MENU button ➔ SOFT Soft ➔  button

The camera applies a slight soft-focus effect over the entire frame for a softer image.

- The camera focuses on the area in the center of the frame. The position of the area cannot be moved.

## Selective color

Rotate the mode dial to SCENE ➔ MENU button ➔  Selective color ➔  button

Keeps only a selected color and makes other colors black-and-white.

- 1 Use the command dial to select the desired color, and press the  button to apply the color.**



- To change the color selection, press the  button again.

- 2 Frame the subject and take a picture.**



- The camera focuses on the area in the center of the frame. The position of the area cannot be moved.

## Multiple exp. Lighten

Rotate the mode dial to SCENE ➔ MENU button ➔

 Multiple exp. Lighten ➔  button

Light trails such as the flow of car lights or motion of stars are captured. The camera automatically captures moving subjects at regular intervals, compares each image and composites only their bright areas, and then saves them as one image.

Option	Description
 <b>Nightscape + light trails</b>	Use to capture the flow of car lights against a night landscape background.
 <b>Star trails</b>	Use to capture the motion of stars.
 <b>Fireworks</b>	Use to capture fireworks.

---

# 1 Select [Nightscape + light trails], [Star trails], or [Fireworks].

- For **[Nightscape + light trails]**:
  - You can rotate the command dial to set the desired interval between the shots. The set interval becomes the shutter speed.



- Set the focus on the subject (□119).
- For **[Star trails]**:
  - Set the focus on the subject (□119).
- For **[Fireworks]**:
  - You can rotate the command dial to set the desired interval between the shots. The set interval becomes the shutter speed.
  - You can rotate the multi selector to set the aperture.
  - Set the focus on the subject (□119).

---

# 2 Press the shutter-release button to start shooting.

- The screen may turn off during the shooting interval. The power-lamp turns on while the screen is off.

---

### 3 After capturing the desired composite image, press the button to end shooting.

- If you continue shooting, details in the composited areas may be lost.
- For [**Nightscape + light trails**]:
  - When 50 shots are taken, the camera automatically stops shooting.
  - For every 10 shots taken, one composite image with trails overlapped from the start of shooting is automatically saved.
- For [**Star trails**]:
  - Shots are taken at a shutter speed of 25 seconds, with an interval of approximately 5 seconds between the shots. When 300 shots are taken, the camera automatically stops shooting.
  - For every 30 shots taken, one composite image with trails overlapped from the start of shooting is automatically saved.
- For [**Fireworks**]:
  - When 30 shots are taken, the camera automatically stops shooting.
  - For every shot taken, one composite image is automatically saved.

---

#### **Notes about [Multiple exp. Lighten]**

- Use a sufficiently charged battery to prevent the camera from turning off unexpectedly.
  - Do not rotate the mode dial or remove the memory card until shooting ends.
  - Use of a tripod is recommended. When using a tripod to stabilize the camera during shooting, select the setup menu → [**Vibration reduction**] → [**Off**]. See “Using a Tripod” (☐63) when using a tripod.
  - The auto off function is disabled during shooting.
  - Exposure compensation cannot be used.
-

---

**Tip: Focusing in [Nightscape + light trails]**

- During autofocus, the camera focuses on the area in the center of the frame. You can set the focus mode to **AF [Autofocus]** (default setting) or **▲ [Infinity]**.
- When shooting distant subjects, it is recommended that you select **▲ [Infinity]** or use manual focus.

**Tip: Focusing in [Star trails]**

During autofocus, the setting is fixed to **∞ [Infinity]** and the focus area is not displayed. To adjust the focus, switch to manual focus (□140).

**Tip: Focusing in [Fireworks]**

- You can set the focus mode during autofocus to **∞ [Infinity]** (default setting) or **▲ [Infinity]**. The focus area is not displayed during **∞ [Infinity]**. During **▲ [Infinity]**, the camera focuses on the area in the center of the frame.
- To adjust the focus, switch to **▲ [Infinity]** (□133) or manual focus (□140).

**Tip: Time remaining**

You can check the time remaining until shooting automatically ends on the screen.



# Setting the flash mode, self-timer, focus mode, and exposure compensation

When the shooting screen is displayed, you can press the multi selector **▲** (⚡) **▶** (☒) **▼** (🌸) **◀** (🕒) to set the functions described below.

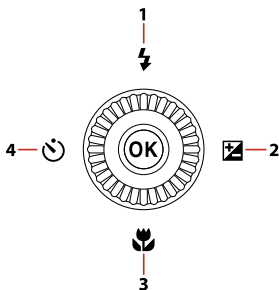

- |   |  |
|---|--|
| 1 | <b>Flash mode</b> (☐122)<br>The flash mode can be set according to shooting conditions.  |
| 2 | <b>Exposure compensation</b> (☐144)<br>You can adjust overall image brightness.  |
| 3 | <b>Focus mode</b> (☐132)<br>When the focus-mode selector is set to <b>AF</b> (autofocus), you can specify the focus mode according to the distance to the subject.   |
| 4 | <b>Self-timer</b> (☐127)/ <b>Smile timer</b> (☐130)<br>The camera releases the shutter when the specified time elapses after you press the shutter-release button. If ☒ [Smile timer] is set, the camera automatically releases the shutter whenever a smiling face is detected. |

The functions that can be set vary depending on the shooting mode.

# Flash mode

You can change the flash settings to match the shooting conditions.

- 1 Move the  (flash pop-up) control to raise the built-in flash.**

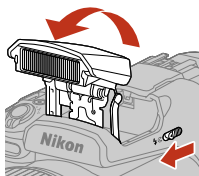

- When the built-in flash is lowered, flash operation is disabled and  is displayed on the shooting screen.
- Make sure that the built-in flash is lowered when using a Speedlight.

- 2 Press the multi selector .**

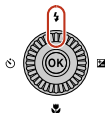

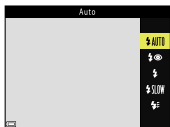

### 3 Select the desired flash mode and press the **OK** button.



- For information about the types of flash modes, see “Available flash modes” (□123).
- If the setting is not applied by pressing the **OK** button, the selection will be canceled.

#### ✔ The flash-ready indicator

While the built-in flash is charging,  flashes. The camera cannot shoot images.

If charging is complete,  is displayed steadily when you press the shutter-release button halfway.



## Available flash modes

Option	Description
 <b>AUTO Auto</b>	The flash fires when necessary, such as in dim lighting. <ul style="list-style-type: none"><li>• The flash mode indicator is only displayed immediately after setting on the shooting screen.</li></ul>

Option	Description
<b>⚡👁️ Auto with red-eye reduction/ Red-eye reduction</b>	Reduce red-eye in portraits caused by the flash (☐125). <ul style="list-style-type: none"> <li>• When [<b>Red-eye reduction</b>] is selected, the flash fires whenever a picture is taken.</li> </ul>
<b>⚡ Fill flash/ Standard flash</b>	The flash fires whenever a picture is taken.
<b>⚡SLOW Slow sync</b>	Suited to evening and night portraits that include background scenery. Fill flash fires to illuminate the main subject; slow shutter speeds are used to capture background at night or under dim lighting.
<b>⚡🚪 Rear-curtain sync</b>	Fill flash fires just before the shutter closes, creating the effect of a stream of light following moving subjects.

### ✔️ Notes about shooting with the flash

- When you use the flash at the wide-angle zoom position, the edge of the image may be dark depending on the shooting distance. This may be improved by adjusting the zoom slightly to a telephoto position.
- When the zoom position is set to a focal length equivalent to that of a lens longer than 2000 mm in 35mm [135] format, the light from the built-in flash will not reach the subject (when ISO sensitivity is set to [**Auto**]).

## Tip: The flash mode setting

The available flash modes differ depending on the shooting mode.

Flash mode		☑1	SCENE, ●, 🦋, 📷	📷	P1	S1	A1	M1
⚡AUTO	Auto	✓	2	✓	-	-	-	-
⚡👁️	Auto with red-eye reduction	✓		✓	-	-	-	-
	Red-eye reduction	-		-	✓	✓	✓	✓
⚡	Fill flash	✓		✓	-	-	-	-
	Standard flash	-		-	✓	✓	✓	✓
⚡SLOW	Slow sync	✓		✓	✓	-	✓	-
⚡🔄	Rear-curtain sync	✓		✓	✓	✓	✓	✓

- 1 When shooting with ⚡👁️ [Auto with red-eye reduction] in 📷 (auto) mode, and when shooting mode **P**, **S**, **A**, or **M** is used, the applied setting is saved in the camera's memory even after the camera is turned off.
- 2 Availability depends on the setting (☐146).

## Tip: [Auto with red-eye reduction]/[Red-eye reduction]

The red-eye reduction lamp glows before the main flash to reduce the red-eye effect. Note the following when shooting:

- Because the red-eye reduction lamp glows, more time than usual is required until the shutter is released after you press the shutter-release button.
- Red-eye reduction may not produce the desired results in some situations.

## Tip: Using a Speedlight (external flash)

- The built-in flash does not fire when a Speedlight is attached. Make sure that the built-in flash is lowered.

- Turn the camera off when attaching and detaching a Speedlight.
  - The mode names and function names of Speedlights may differ from those of the built-in flash.
  - See “Speedlights (external flash units)” (□□322) and refer to the documentation provided with your Speedlight for more information.
-

# Self-timer

The camera releases the shutter when the set number of seconds elapses after you press the shutter-release button.

## 1 Press the multi selector ◀ (⏻).

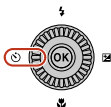

## 2 Select the number of seconds until the shutter is released, and press the OK button.

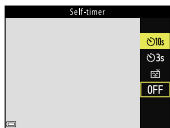

- [⏻10s] (10 seconds): Use on important occasions such as weddings, or to prevent camera shake. This setting is recommended when shooting in a telephoto position with the camera attached to a tripod.
- [⏻3s] (3 seconds): Use to prevent camera shake.
- If the setting is not applied by pressing the OK button, the selection will be canceled.

## 3 Frame the picture and press the shutter-release button halfway.

- Confirm that the subject is in focus.

---

#### 4 Press the shutter-release button all the way down.

- The focus and exposure are locked, and countdown starts.



- The self-timer lamp flashes and then glows steadily about one second before the shutter is released.

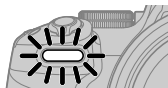

- When the shutter is released, the self-timer is set to **[OFF]**.  
When the shooting mode is Moon, the self-timer is not automatically set to **[OFF]**. To end self-timer, select **[OFF]** in step 2.
- To stop the countdown, press the shutter-release button again.

---

#### ✓ Notes about using a tripod during shooting

- When using a tripod to stabilize the camera during shooting, select the setup menu → **[Vibration reduction]** → **[Off]**. See “Using a Tripod” (□63) when using a tripod.
  - The camera may move slightly when operated, even if it is attached to a tripod, which may interfere with the autofocus. Wait a few seconds after operating the camera, and then slowly press the shutter-release button.
  - If it is difficult for the camera to focus using autofocus, try using manual focus (□140).
  - When using a remote control (available separately) (□318), you can release the shutter without pressing the shutter-release button on the camera.
-

---

**Tip: The self-timer setting**

- The self-timer setting may not be available with some shooting modes (□146).
  - In the setup menu → [**Self-timer: after release**], you can select whether to cancel the self-timer setting after shooting.
-

# Smile timer

When the camera detects a smiling face, you can take a picture automatically without pressing the shutter-release button.

- This function can be used when the shooting mode is **A** (auto), **P**, **S**, **A**, **M**, or **U**, or when the scene mode is [**Portrait**] or [**Night portrait**].

## 1 Press the multi selector ◀ (☺).

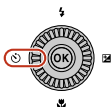

- Change any flash mode, exposure, or shooting menu settings before pressing ◀.

## 2 Select [Smile timer], and press the OK button.



- If the setting is not applied by pressing the OK button, the selection will be canceled.

---

### 3 Frame the picture and wait for the subject to smile without pressing the shutter-release button.



- Point the camera at a human face.
- If the camera detects that the face framed by the double border is smiling, the shutter is automatically released.
- Whenever the camera detects a smiling face, it automatically releases the shutter.
- The shutter-release button can also be used for shooting.

---

### 4 End automatic shooting.

- To end automatic shooting with smile timer, return to step 1 and select **[OFF]**.

---

#### ✓ Notes about [Smile timer]

- When the focus-mode selector is set to **MF** (manual focus), **[Smile timer]** cannot be set.
- Under some shooting conditions, the camera may be unable to detect faces or smiles (□137).

---

#### Tip: When the self-timer lamp flashes

When using **[Smile timer]**, the self-timer lamp flashes when the camera detects a face and flashes quickly immediately after the shutter is released.

---

# Using autofocus

Set the focus-mode selector to **AF** (autofocus) to use autofocus.



## Selecting the focus mode

You can select the focus mode that is appropriate for the shooting distance.

### 1 Press the multi selector ▼ (🌸).

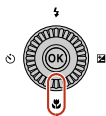

### 2 Select the desired focus mode and press the OK button.

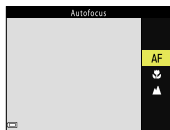

- For information about the types of focus modes, see “Available focus modes” (☞133).
- If the setting is not applied by pressing the OK button, the selection will be canceled.



## ■ Available focus modes

Option	Description
<b>AF Autofocus</b>	<p>Use when the distance from the subject to the lens is 30 cm (1 ft) or more, or 7.0 m (23 ft) or more at the maximum telephoto zoom position.</p> <ul style="list-style-type: none"><li>• The focus mode icon on the shooting screen is displayed only immediately after the setting is made.</li></ul>
<b>📷 Macro close-up</b>	<p>Set when taking close-up pictures.</p> <p>When the zoom ratio is set to a position where 📷 and the zoom indicator are displayed in green, the camera can focus on subjects as close as approximately 10 cm (4 in.) from the lens. When the zoom is at a position more wide-angled than where 📷 is displayed, the camera can focus on subjects as close as approximately 1 cm (0.4 in.) from the lens.</p> 
<b>▲ Infinity</b>	<p>Use when shooting distant scenes through window glass or when shooting landscapes.</p> <p>The camera automatically adjusts the focus near infinity.</p> <ul style="list-style-type: none"><li>• The camera may not be able to focus on nearby objects.</li></ul>
<b>∞ Infinity</b>	<p>Available when the scene mode is set to <b>[Multiple exp. Lighten]</b> → <b>[Fireworks]</b>. Focus is locked to infinity.</p> <ul style="list-style-type: none"><li>• Locked to <b>∞ [Infinity]</b> for some scene modes.</li></ul>

### Tip: The focus mode setting

- The setting may not be available with some shooting modes (☐146).
- For shooting modes **P**, **S**, **A**, and **M**, the setting is saved in the camera's memory even after the camera is turned off.

## The shutter-release button

Operation	Description
<b>Press halfway</b>	<p>To press the shutter-release button “halfway” means to press and hold the button at the point where you feel a slight resistance.</p>  <ul style="list-style-type: none"><li>• Focus and exposure (shutter speed and f-number) are set when you press the shutter-release button halfway. Focus and exposure remain locked while the button is pressed halfway.</li><li>• The focus area varies depending on the shooting mode.</li></ul>
<b>Press all the way</b>	<p>To press the shutter-release button “all the way” means to press the button down completely.</p>  <ul style="list-style-type: none"><li>• The shutter is released when the shutter-release button is pressed all the way.</li><li>• Do not use force when pressing the shutter-release button, as this may result in camera shake and blurred images. Press the button gently.</li></ul>

## Using target finding AF

In  (auto) mode or creative mode, or when [AF area mode] in **P**, **S**, **A**, **M**, or **U** mode is set to [Target finding AF], the camera focuses in the

manner described below when you press the shutter-release button halfway.

- The camera detects the main subject and focuses on it. When the subject is in focus, the focus area is displayed in green. If a human face is detected, the camera automatically sets focus priority on it.

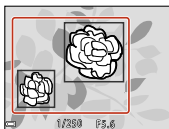

- If no main subject is detected, the camera automatically selects one or more of the nine focus areas containing the subject closest to the camera. When the subject is in focus, the focus areas that are in focus are displayed in green.

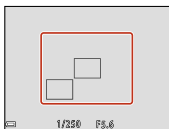

---

## ✔ Notes about target finding AF

- Depending on shooting conditions, the subject that the camera determines to be the main subject may vary.
  - The main subject may not be detected when using certain settings for **[White balance]**, **[Picture Control]**, or effect group in creative mode.
  - The camera may not detect the main subject appropriately in the following situations:
    - When the subject is very dark or bright
    - When the main subject lacks clearly defined colors
    - When the shot is framed so that the main subject is on the edge of the screen
    - When the main subject is composed of a repeating pattern
- 

## Using face detection

In the following settings, the camera uses face detection to automatically focus on human faces.

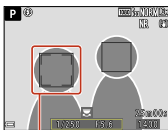

- **[Portrait]** or **[Night portrait]** scene mode
-  **[Smile timer]**
- When **[AF area mode]** is set to **[Face priority]**

If the camera detects more than one face, a double border (❶) is displayed around the face that the camera focuses on, and single borders are displayed around the other faces.



❶

If the shutter-release button is pressed halfway when no faces are detected:

- In **[Portrait]** and **[Night portrait]**, the camera focuses on the area in the center of the frame.
- When **[AF area mode]** is set to **[Face priority]**, the camera selects the focus area containing the subject closest to the camera.
- When  **[Smile timer]** is selected in  (auto), **P**, **S**, **A**, **M**, or **U** mode, the camera automatically selects one or more of the nine focus areas containing the subject closest to the camera.

---

### ✔ **Notes about face detection**

- The camera's ability to detect faces depends on a variety of factors, including the direction in which the faces are looking.
- The camera cannot detect faces in the following situations:
  - When faces are partially hidden by sunglasses or otherwise obstructed
  - When faces take up too much or too little of the frame

---

## **Using skin softening**

In **[Portrait]** or **[Night portrait]** scene mode, if human faces are detected, the camera processes the image to soften facial skin tones before saving the image (up to three faces).

**[Skin softening]** (🗨️259) can also be applied to saved images in playback mode.

---

### ✔ **Notes about skin softening**

- It may take more time than usual to save images after shooting.
- Under some shooting conditions, the desired results may not be achieved, and effects may be applied to areas of the image where there are no faces.

---

## **Subjects not suitable for autofocus**

The camera may not focus as expected in the following situations. In rare cases, the subject may not be in focus despite the fact that the focus area or the focus indicator is displayed in green:

- Subject is very dark

- Objects of sharply differing brightness are included in the shooting conditions (e.g. the sun behind the subject makes that subject appear very dark)
- No contrast between the subject and surroundings (e.g. a portrait subject wearing a white shirt is standing in front of a white wall)
- Point sources of light such as illuminations and night views, or subjects in which brightness changes such as neon lights
- Several objects are at different distances from the camera (e.g. the subject is inside a cage)
- Subjects with repeating patterns (window blinds, buildings with multiple rows of similarly shaped windows, etc.)
- Subject is moving rapidly

In the situations noted above, try pressing the shutter-release button halfway to refocus several times, or focus on another subject positioned at the same distance from the camera as the actual desired subject, and use focus lock (☞138).

The camera can also focus using manual focus (☞140).

## **Focus lock**

Use focus lock to capture creative compositions even when the focus area is set to the center of the frame.

---

**1 Position the subject in the center of the frame and press the shutter-release button halfway.**

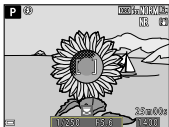

- The camera focuses on the subject and the focus area is displayed in green.
- Exposure is also locked.

---

**2 Without lifting your finger, recompose the picture.**

- Make sure to maintain the same distance between the camera and the subject.



---

**3 Press the shutter-release button all the way down to take the picture.**

---

**Tip: Moving the focus area to the desired position**

In **P**, **S**, **A**, or **M** shooting mode, the focus area can be moved using the multi selector by setting the shooting menu → **[AF area mode]** (□232) to one of the manual options.

**Tip: Using the  $\text{AE-L/AF-L}$  (AE-L/AF-L) button for focus lock**

You can also use the  $\text{AE-L/AF-L}$  (AE-L/AF-L) button to lock the exposure or focus instead of pressing and holding the shutter-release button halfway (□287).

---

## Using manual focus

Set the focus-mode selector to **MF** (manual focus) to adjust the focus manually.

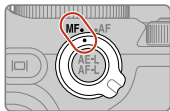

# 1 Use the multi selector or control ring to adjust the focus.

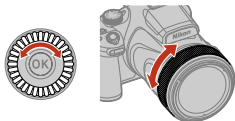

- If the screen above is not displayed, press the multi selector ▼.
- Press ◀ to switch the view between 1×, 2×, and 4×.
- To adjust the focus in higher detail, rotate the multi selector or control ring slowly.
- When ▶ is pressed, the camera focuses on the subject in the center of the frame with autofocus. The manual focus can be operated after the camera focuses with autofocus.
- Focusing is assisted by highlighting areas that are in focus in white (peaking) (☞143). Rotate the command dial to adjust the peaking level (2).

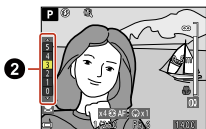

- Press the shutter-release button halfway to confirm the composition of the picture. Press the shutter-release button all the way to take the picture.

## 2 Press the multi selector ▼.



- The set focus is locked.
- Press the shutter-release button all the way to take the picture.
- To readjust the focus, press ▼ to display the screen in step 1.

---

**Tip: Manual focus**

- The digits displayed for the gauge on the right of the screen in step 1 serve as a guideline for the distance to a subject that is in focus when the gauge is near the center.
- The closest distance at which the camera can focus varies depending on the zoom position. At the maximum wide-angle zoom position, the camera can focus on subjects as close as approximately 1 cm (0.4 in.) from the lens. At the maximum telephoto zoom position, the camera can focus on subjects as close as approximately 7.0 m (23 ft) from the lens.
- The actual range at which the subject can be in focus varies depending on the f-number and zoom position. To see whether the subject is in focus, check the image after shooting.
- Select the setup menu → **[Assign side zoom control]** → **[Manual focus]** to focus by using the side zoom control instead of the multi selector or control ring in step 1.

**Tip: Peaking**

- The range of the contrast level considered to be in focus can be changed by adjusting the peaking level. It is effective to set the level low for high contrast subjects, and high for low contrast subjects.
- Peaking highlights high contrast areas of the image in white. Under some shooting conditions, highlighting may not work properly or areas that are not in focus may be highlighted.
- You can disable the peaking display using the setup menu → **[Peaking]**.
- If the setup menu → **[HDMI]** → **[Clean HDMI output]** → **[On]** is selected, the peaking display is disabled when the camera is connected to an HDMI-compatible device.

**Tip: Manual focus during movie recording**

- When the focus-mode selector is set to **MF** and the ● (▶ movie-record) button is pressed, you can adjust the focus while recording movies by rotating the multi selector or control ring.
  - The peaking display is disabled.
  - ◀▶ operation on the multi selector and the focus-mode selector operation are disabled.
-

# Exposure compensation

You can adjust overall image brightness.

**1** Press the multi selector ► (⏏).

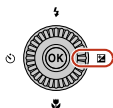

**2** Select a compensation value and press the **OK** button.

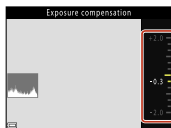

- To brighten the image, set a positive (+) value.
- To darken the image, set a negative (-) value.
- The compensation value is applied, even without pressing the **OK** button.

---

### Tip: The exposure compensation setting

- If the setting is applied in **P**, **S**, or **A** mode, it will remain saved in the camera's memory even after the camera is turned off.
- Exposure compensation cannot be used in the following shooting modes:
  - When scene mode is set to [**Fireworks show**], [**Multiple exp. Lighten**], or [**Night sky (150 minutes)**] or [**Star trails (150 minutes)**] in [**Time-lapse movie**]
  - **M** (manual) mode
  - [**Manual**] in **Movie manual** mode
- When the exposure compensation is set while using the built-in flash, the compensation is applied to both the background exposure and the flash output.
- Exposure compensation can also be set with the control ring (□286).

### Tip: Using the histogram



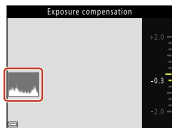







A histogram is a graph showing the distribution of tones in the image. Use as a guide when using exposure compensation and shooting without the flash.





































- The horizontal axis corresponds to pixel brightness, with dark tones to the left and bright tones to the right. The vertical axis shows the number of pixels.
  - Increasing the exposure compensation value shifts the tone distribution to the right, and decreasing it shifts the tone distribution to the left.
-

## Default settings (flash, self-timer, and focus mode)

The default settings for each shooting mode are listed below.

	Flash mode	Self-timer	Focus mode
 (auto)	 AUTO	OFF1	AF
 (portrait)	 	OFF1	AF2
 (landscape)	 2	OFF	 2
 (sports)	 2	OFF2	AF2
 (night portrait)	  3	OFF1	AF2
 (party/indoor)	  4	OFF	AF2
 (beach)	 AUTO	OFF	AF5
 (snow)	 AUTO	OFF	AF5
 (sunset)	 2	OFF	 2
 (dusk/dawn)	 2	OFF	 2
 (night landscape)	 2	OFF	 2
 (close-up)	 AUTO <sup>6</sup>	OFF	 2
 (food)	 2	OFF	 2
 (fireworks show)	 2	OFF2	 2
 (backlighting)	 /  7	OFF	AF2
 (easy panorama)	 2	OFF2	AF2
 (pet portrait)	 2	 8	AF5
SOFT (soft)	 AUTO	OFF	AF

	Flash mode	Self-timer	Focus mode
 (selective color)	 AUTO	OFF	AF
 (multiple exp. lighten)	 2	OFF	AF/  <sup>9</sup>
 (time-lapse movie)	 2	OFF	AF/  /  <sup>10</sup>
 (superlapse movie)	 2	OFF	AF
 (moon)	 2	 3s	 <sup>2</sup>
 (bird-watching)	 2	OFF	AF <sup>11</sup>
 (movie manual)	 2	OFF	AF
 (creative)	 AUTO	OFF	AF <sup>5</sup>
<b>P, S, A, and M</b>		OFF <sup>1</sup>	AF
<b>U</b> (user settings)		OFF <sup>1</sup>	AF

- 1  **[Smile timer]** can also be selected.
- 2 Cannot be changed.
- 3 Cannot be changed. When set to **[Hand-held]**, the flash mode setting is fixed at fill flash with slow sync and red-eye reduction. When set to **[Tripod]**, the flash mode setting is fixed at auto with slow sync and red-eye reduction.
- 4 May switch to slow sync with red-eye reduction flash mode.
- 5 AF **[Autofocus]** or  **[Macro close-up]** can be selected.
- 6 The flash mode is fixed at  (off) when using **[Noise reduction burst]**.
- 7 When **[HDR]** is set to **[Off]**, the flash mode is fixed at  **[Fill flash]**. When **[HDR]** is set to **[On]**, the flash mode is fixed at  (off).
- 8  **[Pet portrait auto release]** can be used. [ 10s] or [ 3s] cannot be used.
- 9 When using **[Nightscape + light trails]**, AF **[Autofocus]** or  **[Infinity]** can be selected. When using **[Star trails]**, the focus mode is fixed at  **[Infinity]**. When using **[Fireworks]**,  **[Infinity]** or  **[Infinity]** can be selected.

- 10 The focus is fixed at AF [**Autofocus**] when using [**Cityscape (10 minutes)**], at ▲ [**Infinity**] when using [**Landscape (25 minutes)**] or [**Sunset (50 minutes)**], or at ∞ [**Infinity**] when using [**Night sky (150 minutes)**] or [**Star trails (150 minutes)**].
- 11 Can be selected from AF [**Autofocus**] or ▲ [**Infinity**].

## Using the Fn (function) button

If you press the Fn button in **P**, **S**, **A**, **M**, or **U** mode, you can quickly configure the pre-saved menu options.

- 1 Press the Fn (function) button when the shooting screen is displayed.**

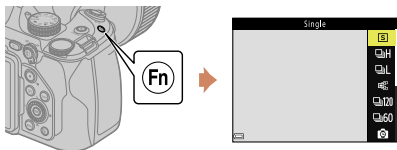

- The setting options of the menu that was set (default setting is **[Continuous]**) and **[Fn button]** can be selected.

## 2 Use the multi selector to select a setting and press the **OK** button.



- If the setting is not applied by pressing the **OK** button, the selection will be canceled.
- To return to the shooting screen without changing the setting, press the **Fn** button or shutter-release button.
- To set a different menu option, select **[Fn button]** and press the **OK** button. Select the desired menu option and press the **OK** button to set it.



- The menu options listed below can be saved.

Image quality (☞209)

Image size (☞212)

Picture Control (☞213)

White balance (☞219)

Metering (☞223)

Continuous (☞224)



ISO sensitivity (☞229)

AF area mode (☞232)

Vibration reduction (☞283)

## Assigning menu options to the Fn buttons of the ML-L7 Remote Control (available separately)

You can also set the Fn1 or Fn2 button of the ML-L7 Remote Control (available separately) in the same way as the Fn button on COOLPIX P1100.

- 1 Establish a Bluetooth connection between the camera and remote control (□329).**
- 2 Rotate the mode dial to P, S, A, M, or U.**
- 3 Press the Fn1 (function 1) or Fn2 (function 2) button on the ML-L7 Remote Control when the shooting screen is displayed.**
  - The same menu options when the Fn button on the camera is pressed are displayed.
- 4 Press the multi selector ▲▼ on the ML-L7 Remote Control, select  [Fn button], and press the  (apply selection) button.**



- 5 Select a menu option to save and press the  button on the ML-L7 Remote Control.**
  - The selected menu option is saved to the Fn1 or Fn2 button.

# Using the zoom

## Using the zoom control

When you move the zoom control, the zoom lens position changes.

- To zoom in (telephoto position): Move toward **T**



- To zoom out (wide-angle position): Move toward **W**



- Rotating the zoom control all the way in either direction adjusts the zoom quickly.
- The zoom indicator and focal length (in 35mm [135] format) are displayed on the shooting screen when the zoom control is moved.
- Digital zoom (2), which allows you to further magnify the subject up to approximately 4× the maximum optical zoom ratio, can be activated by moving and holding the zoom control toward **T** when the camera is zoomed in to the maximum optical zoom position (1).

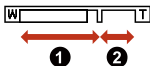

---

### ✔ Notes about digital zoom when recording movies

- The zoom indicator is not displayed while recording a movie.
  - If you keep zooming while recording a movie, zooming stops at the position where optical zoom switches to digital zoom. To continue zooming, briefly release your finger from the zoom control before resuming operation of the zoom control.
  - The zoom ratio of the digital zoom is limited to approximately 3.6× when **[Movie options]** is set to **[2160/30p]** (4K UHD) or **[2160/25p]** (4K UHD) while recording a movie.
- 

### Tip: Digital zoom and Dynamic Fine Zoom

The zoom indicator changes to blue when the digital zoom is activated, and it changes to yellow when the zoom magnification is increased further.

- Zoom indicator is blue: Image quality is not noticeably reduced by using the Dynamic Fine Zoom.
  - Zoom indicator is yellow: There may be cases in which image quality is noticeably reduced.
  - The indicator remains blue across a wider area when the image size is smaller.
  - The zoom indicator may not change to blue when using certain continuous shooting settings or other settings.
- 

## Using the side zoom control

The zoom can also be operated by moving the side zoom control toward **T** or **W** instead of the zoom control.



The function of the side zoom control can be set in the setup menu → **[Assign side zoom control]**.

---

### Tip: Zoom speed



Rotating the zoom control all the way in either direction adjusts the zoom faster than the side zoom control.

---

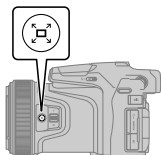

## Using the snap-back zoom (temporarily widening the visible range)

If you lose sight of the subject while shooting with the lens in telephoto position, press the  (snap-back zoom) button to temporarily widen the visible area so that you can frame the subject more easily.



- While pressing the  button, frame the subject inside the framing border (1) of the shooting screen. To widen the visible area further, move the zoom control toward **W** while pressing the  button.



- Release the  button to return to the original zoom position.
- You can select the setup menu → **[Snap-back zoom]** to specify the size of the area that is visible when the  button is pressed.
- Snap-back zoom is not available in the following situations.

- While pressing the shutter-release button halfway
- During movie recording

## Functions that cannot be used simultaneously when shooting

Some functions cannot be used with other menu settings.

Restricted function	Description
Flash mode	<ul style="list-style-type: none"><li>• When the focus mode is set to ▲ [Infinity], the flash cannot be used.</li><li>• When [Continuous] is set to a setting other than [Single] and [Intvl timer shooting], the flash cannot be used.</li><li>• When [Exposure bracketing] is set to a setting other than [Off], the flash cannot be used.</li></ul>
Self-timer/ Smile timer	<ul style="list-style-type: none"><li>• When the focus mode is set to a setting other than AF [Autofocus], ☺ [Smile timer] is set to [OFF].</li><li>• When [AF area mode] is set to [Subject tracking], the self-timer/smile timer cannot be used.</li></ul>
Focus mode	When [Smile timer] is set, the focus mode is fixed at AF [Autofocus].
Image quality	<ul style="list-style-type: none"><li>• When [Continuous] is set to [Pre-shooting cache], [Image quality] is fixed at [Normal].</li><li>• When [Continuous] is set to [Continuous H: 120 fps] or [Continuous H: 60 fps], [RAW], [RAW + Fine], or [RAW + Normal] in [Image quality] cannot be selected.</li><li>• When [Multiple exposure] → [Multiple exposure mode] → [On] is set, [RAW], [RAW + Fine], or [RAW + Normal] in [Image quality] cannot be selected.</li></ul>

Restricted function	Description
Image size	<ul style="list-style-type: none"> <li>• [Image size] is fixed at <math>\frac{16}{3}</math> [4608×3456] when [Image quality] is set to [RAW].</li> <li>• When [Image quality] is set to [RAW + Fine] or [RAW + Normal], the [Image size] of JPEG images can be set. However, <math>\frac{16}{3}</math> [4608×2592], <math>\frac{3}{2}</math> [4608×3072], or <math>\frac{1}{2}</math> [3456×3456] cannot be selected.</li> <li>• [Image size] is set as follows depending on the [Continuous] setting: <ul style="list-style-type: none"> <li>- [Pre-shooting cache]: <math>\frac{1}{4}</math> (image size: 1280 × 960 pixels)</li> <li>- [Continuous H: 120 fps]: <math>\frac{VGA}{2}</math> (image size: 640 × 480 pixels)</li> <li>- [Continuous H: 60 fps]: <math>\frac{1080}{2}</math> (image size: 1920 × 1080 pixels)</li> </ul> </li> </ul>
Picture Control	<ul style="list-style-type: none"> <li>• When [AF area mode] is set to [Subject tracking], [Monochrome] in [Picture Control] cannot be selected.</li> <li>• When [Active D-Lighting] is set to a setting other than [Off], [Contrast] in [Picture Control] cannot be adjusted manually.</li> </ul>
White balance	When [Picture Control] is set to [Monochrome], [White balance] is fixed at [Auto (normal)].
Metering	When [Active D-Lighting] is set to a setting other than [Off], [Metering] is reset to [Matrix].

Restricted function	Description
<b>Continuous</b>	<ul style="list-style-type: none"> <li>• [<b>Exposure bracketing</b>] and [<b>Multiple exposure</b>] cannot be used at the same time with [<b>Continuous</b>].</li> <li>• If the self-timer is set to [<b>10s</b>] (10 seconds) or [<b>3s</b>] (3 seconds) and the shutter-release button is released after the self-timer countdown has started, images are not captured continuously even when [<b>Continuous H</b>] or [<b>Continuous L</b>] is set.</li> <li>• If the self-timer is set to [<b>10s</b>] (10 seconds) or [<b>3s</b>] (3 seconds), images are not captured continuously even when [<b>Pre-shooting cache</b>] is set.</li> <li>• If the self-timer is set to [<b>10s</b>] (10 seconds) or [<b>3s</b>] (3 seconds), shooting finishes after one image is shot even when [<b>Intvl timer shooting</b>] is set.</li> <li>• Only one image is shot when shooting with the automatic shutter in [<b>Smile timer</b>]. Interval shooting finishes after one image is shot.</li> <li>• When [<b>Image quality</b>] is set to [<b>RAW</b>], [<b>RAW + Fine</b>], or [<b>RAW + Normal</b>], [<b>Pre-shooting cache</b>], [<b>Continuous H: 120 fps</b>], or [<b>Continuous H: 60 fps</b>] cannot be used.</li> </ul>
<b>Exposure bracketing</b>	<ul style="list-style-type: none"> <li>• The following cannot be used at the same time with [<b>Exposure bracketing</b>]. <ul style="list-style-type: none"> <li>- [<b>Continuous</b>]</li> <li>- [<b>Multiple exposure</b>]</li> <li>- Self-timer</li> <li>- [<b>Smile timer</b>]</li> </ul> </li> <li>• When [<b>Picture Control</b>] is set to [<b>Monochrome</b>], [<b>Exposure bracketing</b>] cannot be used.</li> </ul>

Restricted function	Description
<b>ISO sensitivity</b>	<ul style="list-style-type: none"> <li>• When [<b>Continuous</b>] is set to [<b>Pre-shooting cache</b>], [<b>Continuous H: 120 fps</b>], or [<b>Continuous H: 60 fps</b>], [<b>ISO sensitivity</b>] is fixed at [<b>Auto</b>].</li> <li>• When the shooting mode is Movie manual and [<b>Movie options</b>] is set to an HS movie, [<b>ISO sensitivity</b>] is fixed at [<b>Auto</b>].</li> </ul>
<b>AF area mode</b>	<ul style="list-style-type: none"> <li>• When [<b>Smile timer</b>] is set, the camera captures images using face detection regardless of the applied [<b>AF area mode</b>] option.</li> <li>• When [<b>AF area mode</b>] is set to a setting other than [<b>Subject tracking</b>] and the focus mode is set to ▲ [<b>Infinity</b>], the camera focuses at infinity regardless of the applied [<b>AF area mode</b>] option.</li> <li>• When [<b>Picture Control</b>] is set to [<b>Monochrome</b>], [<b>Subject tracking</b>] cannot be set.</li> <li>• When [<b>Target finding AF</b>] is set and [<b>White balance</b>] is set to a setting other than [<b>Auto (normal)</b>], the camera focuses on a face or selects one or more of the nine focus areas containing the subject closest to the camera.</li> </ul>
<b>Autofocus mode</b>	<ul style="list-style-type: none"> <li>• When [<b>Smile timer</b>] is set, [<b>Autofocus mode</b>] operates using [<b>Single AF</b>].</li> <li>• When the focus mode is ▲ [<b>Infinity</b>], the autofocus mode operates using [<b>Single AF</b>].</li> </ul>
<b>Multiple exposure</b>	<ul style="list-style-type: none"> <li>• When [<b>Image quality</b>] is set to [<b>RAW</b>], [<b>RAW + Fine</b>], or [<b>RAW + Normal</b>], [<b>Multiple exposure</b>] cannot be used.</li> <li>• [<b>Continuous</b>] and [<b>Exposure bracketing</b>] cannot be used at the same time with [<b>Multiple exposure</b>].</li> </ul>

Restricted function	Description
<b>Monitor settings</b>	<ul style="list-style-type: none"> <li>• When the focus area is selected with [<b>AF area mode</b>] set to [<b>Manual (spot)</b>], [<b>Manual (normal)</b>], or [<b>Manual (wide)</b>], the histogram is not displayed.</li> <li>• When [<b>AF area mode</b>] is set to [<b>Subject tracking</b>] and after the subject has been registered (during subject tracking), the histogram is not displayed.</li> <li>• When [<b>AF area mode</b>] is set to [<b>Target finding AF</b>], the histogram is not displayed.</li> </ul>
<b>Date stamp</b>	<ul style="list-style-type: none"> <li>• When [<b>Image quality</b>] is set to [<b>RAW</b>], [<b>RAW + Fine</b>], or [<b>RAW + Normal</b>], date and time cannot be stamped on images.</li> <li>• When [<b>Continuous</b>] is set to [<b>Pre-shooting cache</b>], [<b>Continuous H: 120 fps</b>], or [<b>Continuous H: 60 fps</b>], date and time cannot be stamped on images.</li> </ul>
<b>Digital zoom</b>	<ul style="list-style-type: none"> <li>• When [<b>Smile timer</b>] is selected, digital zoom cannot be used.</li> <li>• When [<b>Image quality</b>] is set to [<b>RAW</b>], [<b>RAW + Fine</b>], or [<b>RAW + Normal</b>], digital zoom cannot be used.</li> <li>• When [<b>AF area mode</b>] is set to [<b>Subject tracking</b>], digital zoom cannot be used.</li> <li>• When [<b>Zoom memory</b>] is set to [<b>On</b>], digital zoom cannot be used.</li> </ul>
<b>Shutter sound</b>	<ul style="list-style-type: none"> <li>• When [<b>Continuous</b>] is set to [<b>Pre-shooting cache</b>], [<b>Continuous H: 120 fps</b>], or [<b>Continuous H: 60 fps</b>], shutter sound is disabled.</li> <li>• When [<b>Exposure bracketing</b>] is set to a setting other than [<b>Off</b>], shutter sound is disabled.</li> </ul>

---

**✔ Notes about digital zoom**

- Depending on the shooting mode or the current settings, digital zoom may not be available (☐☐285).
  - When digital zoom is in effect, selectable options for AF area mode or metering mode are restricted.
-

# Playback features

## Playback zoom

Move the zoom control toward **T** (Q) in full-frame playback mode (1) to zoom in on an image (2).

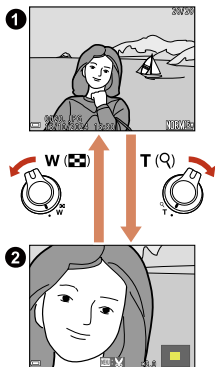

### Operations during playback zoom

Function	Operation
Adjust the magnification rate	Move the zoom control ( <b>W</b> (⊞)/ <b>T</b> (Q)). The zoom can also be adjusted by rotating the command dial.

Function	Operation
<b>Move the display position</b>	<p>Press the multi selector ▲▼◀▶.</p> <p>The display position of the zoomed image is displayed as the yellow area at the bottom right of the screen.</p> <ul style="list-style-type: none"> <li>· If you are viewing an image that was captured using face detection or pet detection, the camera zooms in on the face detected at the time of shooting (except images captured using <b>[Continuous]</b> or <b>[Exposure bracketing]</b>). To zoom in on an area of the image where there are no faces, adjust the magnification rate and then press ▲▼◀▶.</li> </ul>
<b>Crop the image</b>	Press the MENU button (□164).
<b>Return to full-frame playback mode</b>	Press the  button.

# Crop

Trim images down only to the parts you need.

- See “Before editing images” (173) for information about restrictions on editing.

## 1 Move the zoom control toward **T** (🔍) in full-frame playback mode to zoom in on the image.



## 2 Adjust the magnification rate and display position to display only the part to trim down.

- To change the magnification rate, move the zoom control toward **T** (🔍) or **W** (📐). Set a magnification rate at which **MENU** (☰) is displayed.
- To view a different area of the image, press the multi selector **▲▼** (◀▶).

## 3 Press the MENU button.

---

## 4 Check the image and press the **OK** button.



- To change the portion you want to keep, return to step 2 by pressing **◀**.
- To exit without saving the cropped image, press the **MENU** button.

---

## 5 When the confirmation dialog is displayed, select **[Yes]** and press the **OK** button.

- An edited copy is created.

---

### ✓ **Notes about cropping**

Images captured using easy panorama cannot be edited.

---

#### **Tip: Image size**

- The aspect ratio (horizontal to vertical) of the cropped copy is the same as the original.
  - When the image size of the cropped copy is 320 × 240 or smaller, the image is displayed at a smaller size during playback.
-

# Thumbnail playback/calendar display

In full-frame playback mode (❶), move the zoom control toward **W** (📺) to switch to thumbnail playback mode (❷) and display multiple images on the screen, or to switch to calendar display (❸) and display images by date.

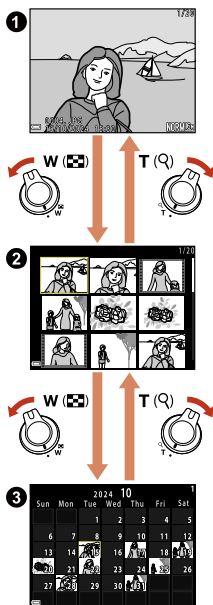

## ■ Operations during thumbnail playback/calendar display

Function	Operation
Change the number of thumbnails displayed	Move the zoom control ( <b>W</b> (📐)/ <b>T</b> (🔍)).
Select an image in thumbnail playback mode and display it in full-frame playback mode	Use the multi selector ▲▼◀▶ or rotate it to select an image, and press the <b>OK</b> button.
Display images captured on a date selected in calendar display	Use ▲▼◀▶ or rotate the multi selector to select a date, and press the <b>OK</b> button.

### ✔ Notes about calendar display

Images captured when the camera's date is not set are treated as images captured on January 1, 2025.

# Viewing and deleting images captured continuously (sequence)

## Viewing images in a sequence

Images captured continuously are saved as a sequence.

The first image of a sequence is used as the key picture to represent the sequence when displayed in full-frame playback mode or thumbnail playback mode (default setting). To display each image in the sequence individually, press the **OK** button.



## Operations in full-frame playback mode



Function	Operation
Zoom in on the image	Move the zoom control toward <b>T</b> ( <b>Q</b> ) ( <b>□</b> 162).
Change the displayed image	Rotate the multi selector or press <b>◀▶</b> .

Function	Operation
<b>Display images that are not included in the sequence</b>	Press ▲ to return to the key picture display.

### ✔ Notes about sequence display options

- Images captured continuously with cameras other than this camera cannot be displayed as a sequence.
- If the number of sequences saved on the memory card in the camera exceeds 1,000, the images captured thereafter cannot be displayed as sequences. To continue capturing images in sequences, either delete sequences that you do not need to keep, or replace the memory card. However, even if you delete sequences, images that were not included in a sequence when they were captured cannot be displayed as a sequence.

### Tip: Displaying images in a sequence

- To disable sequence display, select the playback menu → [Sequence display options] → [Individual pictures].
- When the playback menu → [Sequence display options] is set to [Key picture only], images in a sequence cannot be displayed as thumbnails.

### Tip: Playback menu options available when using sequence

- When images in a sequence are displayed in full-frame playback mode, press the MENU button to select functions in playback menu (□205).
- If the playback menu → [Sequence display options] is set to [Key picture only] and you start [Slide show] while images in a sequence are displayed, the images in that group will be played back in order. If you start [Slide show] while images other than those in a sequence are displayed, only key pictures of sequences will be displayed.
- If you press the MENU button when a key picture is displayed, the following settings can be applied to all images in the sequence:
  - Mark for upload, Protect

## Deleting images in a sequence

When the  (delete) button is pressed for images in a sequence, the images that are deleted vary depending on how the sequences are displayed.

- When the key picture is displayed:
  - [**Current image**]: All images in the displayed sequence are deleted.
  - [**Erase selected images**]: When a key picture is selected on the image selection screen for deletion (step 3 in “Deleting images” (□70)), all images in that sequence are deleted.
  - [**All images**]: All images on the memory card are deleted.
- When images in a sequence are displayed:
  - [**Current image**]: The image currently displayed is deleted.
  - [**Erase selected images**]: Images that are selected in the sequence are deleted.
  - [**Entire sequence**]: All images in the displayed sequence are deleted.

## Playback with easy panorama

Switch to playback mode (📺68), display an image captured using easy panorama in full-frame playback mode, and then press the **OK** button to scroll the image in the direction that was used when shooting.











• Rotate the multi selector to fast-forward or rewind scroll playback. Playback controls are displayed on the screen during playback.



Use the multi selector **◀▶** to select a control, and then press the **OK** button to perform the operations described below.

Icon	Description
	End playback and return to full-frame playback mode.
	Hold down the <b>OK</b> button to rewind scroll playback. This operation can also be performed by rotating the multi selector.

Icon	Description
	<p>Pause playback. The operations listed below can be performed while paused.</p> <ul style="list-style-type: none"> <li>• : Scroll one step to the left. Hold down the  button to scroll continuously. This operation can also be performed by rotating the multi selector.</li> <li>• : Resume automatic scrolling.</li> <li>• : Scroll one step to the right. Hold down the  button to scroll continuously. This operation can also be performed by rotating the multi selector.</li> </ul>
	<p>Hold down the  button to fast-forward scroll playback. This operation can also be performed by rotating the multi selector.</p>

### **Notes about easy panorama images**

- The images cannot be edited on this camera.
- This camera may not be able to scroll the playback of, or zoom in on, easy panorama images captured with another make or model of digital camera.

### **Notes about printing panorama images**

The entire image may not be able to be printed depending on the printer's settings. Additionally, printing may not be possible depending on the printer.

## Editing images (still images)

You can use the following image editing functions with this camera.

Quick retouch (☐257)

D-Lighting (☐258)

Skin softening (☐259)

Filter effects (☐260)

Small picture (☐268)

Crop (☐164)

### **Before editing images**

Images created by editing are saved as files separate from the original images (☐365).

Images created by editing are saved with the same shooting date and time as the original images.

---

#### **Tip: Restrictions on image editing**

- RAW images and images captured using easy panorama cannot be edited.
  - A JPEG image can be edited up to 10 times. A still image created by editing a movie can be edited up to 9 times.
  - You may not be able to edit images of a certain size or with certain editing functions.
-

## Printing still images

You can use one of the following methods to print still images.

- Request at a print service store.
- Insert the memory card into a printer with a memory card slot and print.
- Print from a printer that is connected to a computer (□□312).

---

### **Tip: Printing RAW images**

To print RAW images, download them to a computer and use software NX Studio to perform RAW processing. To use the software, see the online help.

---

### **✓ Notes about printing images at 1:1 aspect ratio**

Change the printer setting to "Border" when printing images at a 1:1 aspect ratio.

Some printers may not be able to print images at a 1:1 aspect ratio (□□212).

---

# Movies

## Basic operations of movie recording and movie playback

### 1 Display the shooting screen.

- Check the remaining amount of movie recording time (❶) on the screen (☞178).
- It is recommended that you display the movie frame (❷) that indicates the area that will be recorded in a movie (☞177).

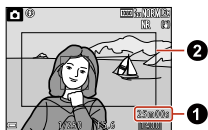

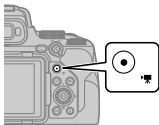

---

## 2 Press the movie-record) button.



- The camera starts recording a movie. The camera focuses in the center of the frame.



- Press the  button to pause recording, and press the  button again to resume recording (except when an HS movie option is selected in **[Movie options]**). Recording automatically ends if it remains paused for about five minutes.

---

## 3 Press the button to end recording.

---

## 4 Select a movie in full-frame playback mode and press the button to play it back.

- An image with a movie options icon is a movie (192).



## ■ Movie frame

- Press the **DISP** button to display the movie frame. Check the range of a movie in a frame before movie recording.
- The area that is recorded in a movie varies depending on the settings of [**Movie options**], [**Electronic VR**], etc. in the movie menu.

## ■ Focusing

- The focus can be adjusted during movie recording in the following manner in accordance with the movie menu → [**Autofocus mode**] setting.
  - AF-S [**Single AF**] (default setting): The focus is locked when movie recording starts. To perform the autofocus function during movie recording, press the multi selector ◀.
  - AF-F [**Full-time AF**]: The focus is adjusted repeatedly even during movie recording. The button that locks the focus depends on the setting in the setup menu → [**AE/AF lock button**]. When [**AE/AF lock**] or [**AF lock only**] is selected, press the  $\text{AE-L/AF-L}$  button during movie recording to lock the focus. To unlock, press the  $\text{AE-L/AF-L}$  button again. When [**AE lock only**] or [**AE lock (Hold)**] is selected, press the multi selector ◀ during movie recording to lock the focus. To unlock, press ◀ again.
- When the focus-mode selector is set to **MF** (manual focus), you can adjust the focus manually while recording movies by rotating the multi selector or control ring.

## ■ Exposure

The button that locks the exposure depends on the setting in the setup menu → [**AE/AF lock button**]. When [**AE/AF lock**], [**AE lock only**], or [**AE lock (Hold)**] is selected, press the  $\text{AE-L}$  button during movie recording to lock the exposure. To unlock, press the  $\text{AE-L}$  button again. When [**AF**

**lock only**] is selected, press the multi selector ► during movie recording to lock the exposure. To unlock, press ► again.

## ■ Maximum movie recording time

The remaining recording time for a single movie is displayed on the shooting screen.

- Individual movie files cannot exceed 29 minutes in length, even when there is sufficient free space on the memory card for longer recording. The maximum size of a single movie file is 4 GB. If a file exceeds 4 GB even when you record for less than 29 minutes, it is split into multiple files and cannot be played back continuously (☐247).
- Recording may end before either limit is reached if camera temperature becomes elevated.
- The actual remaining recording time may vary depending on the movie content, subject movement, or type of memory card.
- Memory cards with an SD Speed Class rating of 6 (Video Speed Class V6) or faster are recommended for recording movies. When **[Movie options]** is set to **[2160/30p]** (4K UHD) or **[2160/25p]** (4K UHD), memory cards with a UHS Speed Class rating of 3 (Video Speed Class V30) or faster are recommended. When using a memory card with a lower Speed Class rating, movie recording may stop unexpectedly.

---

### ✓ Notes about camera temperature

- The camera may become hot when recording movies for an extended period of time or when the camera is used in a hot area.
  - If the inside of the camera becomes extremely hot when recording movies, the camera will automatically stop recording. The amount of time remaining until the camera stops recording (🕒10s) is displayed. After the camera stops recording, it turns itself off. Leave the camera off until the inside of the camera has cooled.
-

## ■ Notes about movie recording

---

### ✓ Notes about saving images or movies

The indicator showing the number of exposures remaining or the indicator showing the remaining recording time flashes, or [**Please wait for the camera to finish recording.**] is displayed while images or movies are being saved. **Do not open the battery-chamber/memory card slot cover or remove the battery or memory card while an indicator is flashing.** Doing this could result in loss of data, or in damage to the camera or the memory card.

### ✓ Notes about recorded movies

- The sounds of control ring operation, zoom control operation, zoom, autofocus lens drive movement, vibration reduction, and aperture operation when brightness changes may be recorded.
- The following phenomena may be seen on the screen while recording movies. These phenomena are saved in the recorded movies.
  - Banding may occur in images under fluorescent, mercury-vapor, or sodium-vapor lighting.
  - Subjects that move quickly from one side of the frame to the other, such as a moving train or car, may appear skewed.
  - The entire movie image may be skewed when the camera is panned.
  - Lighting or other bright areas may leave residual images when the camera is moved.
- Depending on the distance to the subject or the amount of zoom applied, colored stripes may appear on subjects with repeating patterns (fabrics, lattice windows, etc.) during movie recording and playback. This occurs when the pattern in the subject and the layout of the image sensor interfere with each other; it is not a malfunction.



### ✓ Notes about autofocus for movie recording

For “Subjects not suitable for autofocus” (□137), autofocus may not perform as expected. Should this occur, focus using manual focus (□140) or try the following:

1. Select the movie menu → **[Autofocus mode]** → **[Single AF]** (default setting) before starting movie recording.
  2. Frame another subject (positioned at the same distance from the camera as the intended subject) in the center of the frame, press the ● (📷) button to start recording, and modify the composition.
-

## Capturing still images while recording movies

If the shutter-release button is pressed all the way while recording a movie, one frame is saved as a still image (JPEG image). Movie recording continues while the still image is being saved.

- A still image can be captured when  is displayed on the screen. When  is displayed, a still image cannot be captured.



- The size of the captured still image is the same as the movie image size (□247).

---

## ✔ Notes about capturing still images during movie recording

- Still images cannot be saved during movie recording in the following situations:
    - When movie recording is paused
    - When the remaining movie recording time is less than five seconds
    - When **[Movie options]** is set to an HS movie option
  - When the shooting menu → **[Image quality]** is set to **[RAW]** or **[RAW + Fine]**, a still image is captured as **[Fine]**. When **[Image quality]** is set to **[RAW + Normal]**, it is captured as **[Normal]**.
  - Up to 20 still images can be saved while recording a single movie when **[Movie options]** is set to **[2160/30p]** or **[2160/25p]**. Still images are captured as **[Fine]**.
  - It may take some time to save the images after shooting.
  - The frames of a movie that were recorded when a still image was being captured may not play back smoothly.
  - The sounds of operating the shutter-release button when saving a still image may be heard in the recorded movie.
  - If the camera moves when the shutter-release button is pressed, the image may be blurred.
-

# Movie manual

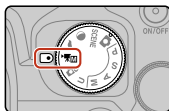

In Movie manual mode, you can use the aperture-priority auto or manual setting to set the exposure (shutter speed and f-number) when recording movies.

Option	Description
<b>Aperture-priority auto (default setting)</b>	When the f-number is set, the camera automatically determines the shutter speed. You can change the f-number to bring the subject, foreground and background into focus, or blur the subject's background intentionally.
<b>Manual</b>	Set both the shutter speed and f-number.

- 1 Press the MENU button, select [Exposure mode], and press the  button.**

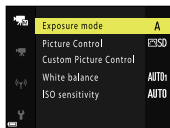

---

## 2 Select [Aperture-priority auto] or [Manual], and press the **OK** button.

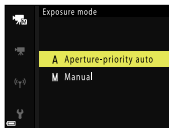

- Set the following options according to your shooting conditions and requirements.
  - [Picture Control]
  - [Custom Picture Control]
  - [White balance]
  - [ISO sensitivity]

---

## 3 Press the MENU button to display the shooting screen.

## 4 Set the exposure.

- Rotate the command dial to set the shutter speed. Rotate the multi selector to set the f-number.

## 5 Press the **●** (▶**REC** movie-record) button to start movie recording.



- In autofocus, the camera focuses in the center of the frame. The focus area is not displayed.
- In autofocus, to check the focus before starting movie recording, press the shutter-release button halfway, or select the movie menu → **[Autofocus mode]** → **[Full-time AF]**.
- The shutter speed or f-number can also be set during movie recording (except when an HS movie option is selected in **[Movie options]**).
- To capture a still image during movie recording, press the shutter-release button all the way (□181).

---

### ✓ **Notes about Movie manual mode**

In Movie manual mode, you cannot capture a still image if you press the shutter-release button before pressing the **●** (▶**REC**) button.

### ✓ **Notes about ISO sensitivity**

- In Movie manual mode, the lowest ISO sensitivity is ISO 125.
- When **[Manual]** is selected for **[Exposure mode]** in Movie manual mode and **[ISO sensitivity]** is set to **[Auto]**, **[ISO 125-400]**, or **[ISO 125-800]**, the ISO sensitivity is fixed at ISO 125.
- When the shooting mode is Movie manual and **[Movie options]** is set to an HS movie, **[ISO sensitivity]** is fixed at **[Auto]**.

---

### **Tip: Shutter speed**

The shutter speed cannot be set slower than the frame rate.

---



## ■ ■ Functions available in Movie manual mode





- Self-timer (☞127)
- Focus mode (☞132)
- Exposure compensation (☞144)
- Movie manual mode menu (☞246)
- Movie menu (☞247)

# Time-lapse movie

The camera can automatically capture still images at a specified interval to create time-lapse movies that are approximately 10 seconds long.

Rotate the mode dial to SCENE ➔ MENU button ➔  Time-lapse movie ➔  button

- When the movie menu ➔ **[Frame rate]** setting is set to **[30 fps (30p/60p)]**, 300 images are captured and saved with  **[1080/30p]**.  
When set to **[25 fps (25p/50p)]**, 250 images are captured and saved with  **[1080/25p]**.

Type (required shooting time)	Interval time	
	30 fps (30p/60p)	25 fps (25p/50p)
 <b>Cityscape (10 minutes)<sup>1</sup></b> <b>(default setting)</b>	2 s	2.4 s
 <b>Landscape (25 minutes)<sup>1</sup></b>	5 s	6 s
 <b>Sunset (50 minutes)<sup>1</sup></b>	10 s	12 s
 <b>Night sky (150 minutes)<sup>2</sup></b>	30 s	36 s
 <b>Star trails (150 minutes)<sup>3</sup></b>	30 s	36 s

- 1 The camera focuses on the area in the center of the frame.
- 2 Suited for recording the movement of stars.
- 3 Star movement appears as lines of light due to image processing.

- 
- 1** Use the multi selector ▲▼ to select a type, and press the **OK** button.

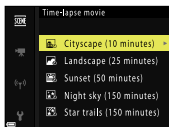

- 
- 2** Select whether or not to fix exposure (brightness), and press the **OK** button (except [Night sky (150 minutes)] and [Star trails (150 minutes)]).

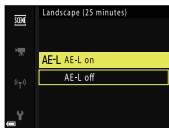

- When [**AE-L on**] is selected, the exposure used for the first image is used for all images. When the brightness changes drastically like at dusk, [**AE-L off**] is recommended.

- 
- 3** Stabilize the camera by using a tool such as a tripod.

- See "Using a tripod" (p.63) when using a tripod.

---

## 4 Press the shutter-release button to capture the first image.



- Set exposure compensation (☐144) before releasing the shutter for the first image (when using [**Night sky (150 minutes)**] or [**Star trails (150 minutes)**], exposure compensation cannot be used). Exposure compensation cannot be changed after the first image is captured. Focus and hue are fixed when the first image is captured.
- When capturing images of stars, it is recommended that you use manual focus (☐140).
- The shutter is automatically released for the second and subsequent images.
- The screen may turn off during the shooting interval.

---

## 5 End shooting.

- Shooting ends automatically when 300 or 250 images are captured.
- To end shooting before it automatically ends, press the **OK** button.

---

### ✓ Notes about [Time-lapse movie]

- Use a sufficiently charged battery to prevent the camera from turning off unexpectedly.
  - Do not rotate the mode dial or remove the memory card until shooting ends.
  - Time-lapse movies cannot be recorded by pressing the **●** (**▶**) button.
  - The auto off function is disabled during shooting.
  - Sound and still images cannot be saved.
-

# Superlapse movie

The camera records movies and saves them in fast motion ( $\overline{1080}$  P [1080/30p] or  $\overline{1080}$  P 25 [1080/25p]). Use to record a movie while moving the camera. The camera compresses the time of changes in the subject and saves the movie.

Rotate the mode dial to SCENE → MENU button →  Superlapse movie →  button

- 1 Use the multi selector ▲▼ to select a playback speed, and press the  button.

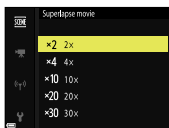

- At the default setting of [2x], a movie recorded for two minutes is played back as a one-minute movie.
- If the recording time of an individual movie file exceeds 29 minutes, recording ends automatically.

---

## 2 Press the ● (▶ movie-record) button to start recording.

- You can check the recording time (❶) and playback time (❷) on the screen.

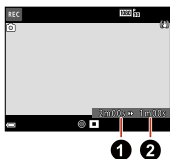

- It is recommended that you display the movie frame that indicates the area that will be recorded in a movie (□177).
- Sound is not recorded.

---

### Tip: Shooting still images

- A still image (16:9 (1920 × 1080 pixels)) can be captured if you press the shutter-release button before pressing the ● (▶ movie-record) button.
  - You can shoot still images while recording movies (□181).
-

# Operations during movie playback

To adjust the volume (❶), move the zoom control.



Rotate the multi selector or the command dial to fast-forward or rewind. Playback controls are displayed on the screen during movie playback. Use the multi selector ◀▶ to select a control, and then press the OK button to perform the operations described below.

- During playback









Icon	Description
■	End playback and return to full-frame playback mode.
◀◀	Hold down the OK button to rewind the movie.
⏸	Pause playback.
▶▶	Hold down the OK button to fast-forward the movie.

- When paused



Icon	Description
■	End playback and return to full-frame playback mode.

Icon	Description
	Rewind the movie one frame. Hold down the  button for continuous rewinding. The movie can also be rewound by one frame by rotating the multi selector or command dial.
	Resume playback.
	Advance the movie one frame. Hold down the  button for continuous advancing. The movie can also be advanced by one frame by rotating the multi selector or command dial.
	Extract the desired portion of a movie and save it as a separate file.
	Extract a single frame of a movie and save it as a still image.

## Editing movies

When editing movies, use a sufficiently charged battery to prevent the camera from turning off during editing.

### Extracting only the desired portion of a movie

The desired portion of a recorded movie can be saved as a separate file.

- 1** Play back a desired movie and pause at the start point of the portion that you want to extract (□192).
- 2** Use the multi selector ◀▶ to select the [192] control, and then press the Ⓞ button.

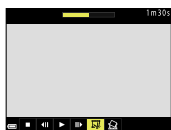

- 3** Use ▲▼ to select [192] (choose start point).



- Use ◀▶ or rotate the command dial to move the start point.
- To cancel editing, select ⏪ (back), and press the Ⓞ button.

---

#### 4 Use ▲▼ to select ⏸ (choose end point).

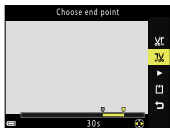

- Use ◀▶ or rotate the command dial to move the end point.
- To preview the specified portion, use ▲▼ to select ▶ and then press the Ⓚ button. Press the Ⓚ button again to stop previewing.

---

#### 5 Use ▲▼ to select □ (save) and press the Ⓚ button.

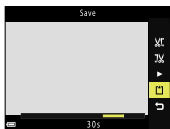

- Follow the instructions on the screen to save the movie.

---

#### ✓ Notes about movie extracting

- A movie that was created by editing cannot be edited again.
- The actual trimmed portion of a movie may differ slightly from the portion selected using the start and end points.
- Movies cannot be trimmed so that they are less than two seconds long.

---

## Saving a frame from a movie as a still image

The desired frame of a recorded movie can be extracted and saved as a still image.

---

#### 1 Pause a movie and display the frame to be extracted (□192).

- 
- 2** Use the multi selector ◀▶ to select the  control, and then press the **OK** button.



- 
- 3** Select [Yes] when a confirmation dialog is displayed, and press the **OK** button.

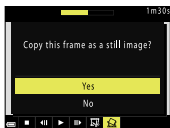

- The still image is saved with **[Normal]** as the image quality. The image size is determined by the original movie image size (□247).

---

### **✓ Restrictions on extracting still images**

Still images cannot be extracted from a movie recorded with an HS movie option.









---

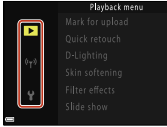

# Using the menu

## Menu operations

You can press the **MENU** (menu) button to display the menu screen and change the camera's settings.

- The displayed menu varies depending on the status of the camera (during shooting or playback).
- Menu items are categorized by the icons on the left side of the screen.

When shooting	During playback
 <p>The screenshot shows the 'Shooting menu' with a vertical list of icons on the left: a yellow 'P' in a black square, a camera icon, a movie camera icon, a Wi-Fi icon, and a person icon. The menu items listed are: Image quality, Image size, Picture Control, Custom Picture Control, White balance, and Metering.</p> <ul style="list-style-type: none"><li>• <b>P</b> Shooting menu<sup>1, 3</sup></li><li>•  Movie manual mode menu<sup>2</sup></li><li>•  Movie menu</li><li>•  Network menu</li><li>•  Setup menu</li></ul>	 <p>The screenshot shows the 'Playback menu' with a vertical list of icons on the left: a yellow play button in a black square, a movie camera icon, a Wi-Fi icon, and a person icon. The menu items listed are: Mark for upload, Quick retouch, D-Lighting, Skin softening, Filter effects, and Slide show.</p> <ul style="list-style-type: none"><li>•  Playback menu</li><li>•  Network menu</li><li>•  Setup menu</li></ul>

- 1 Menu names and icons vary depending on the shooting mode.
- 2 Displayed when the mode dial is rotated to  (Movie manual).
- 3 Displayed when the mode dial is rotated to a mode other than  (Movie manual).

# 1 Press the MENU (menu) button to display the menu screen.

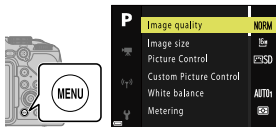

# 2 Press the multi selector ◀ to move to the menu category selection area.

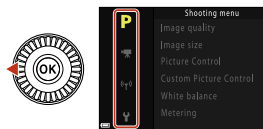

# 3 Press ▲▼ or rotate the multi selector to change menu categories.

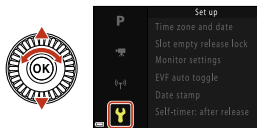

---

## 4 Press the **OK** button to confirm the menu category.

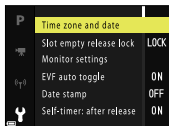

- Menu items corresponding to the selected menu category are displayed.

---

## 5 Press **▲▼** or rotate the multi selector to select a menu option, and press the **OK** button to confirm the selection.

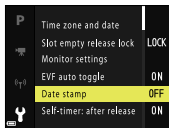

- Certain options cannot be selected depending on the current shooting mode or the state of the camera.

- 6** Press **▲▼** or rotate the multi selector to select a setting, and press the **OK** button to confirm the selection.

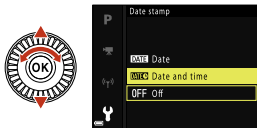

- When you are finished using the menu, press the MENU button.
- When a menu is displayed, you can return to shooting mode by pressing the shutter-release button or **●** (▶ movie-record) button.

---

**Tip: To change the flash mode, self-timer, focus mode, and exposure compensation settings**

You can press the multi selector **▲** (flash mode), **◀** (self-timer), **▼** (focus mode), or **▶** (exposure compensation) to configure them on the shooting screen (□120).

---

## ■ Using the Fn (function) button

If you press the Fn button in **P**, **S**, **A**, **M**, or **U** mode, you can quickly configure the pre-saved menu options (default setting is [**Continuous**]). To set a different menu option, select **Fn** [Fn button] and select the desired menu option.

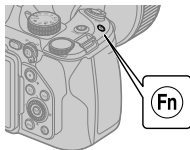

# Menu lists

## The shooting menu

Shooting mode ➔ MENU button

### Common options (except Movie manual mode)

Option	Default setting
Image quality (□209)*	[Normal]
Image size (□212)*	16M [4608×3456]

\* Also can be set by pressing the Fn (function) button (□149).

### For P, S, A, M, and U modes

Option	Default setting
Picture Control (□213) <sup>1</sup>	[Standard]
Custom Picture Control (□217)	—
White balance (□219) <sup>1</sup>	[Auto (normal)]
Metering (□223) <sup>1</sup>	[Matrix]
Continuous (□224) <sup>1</sup>	[Single]
ISO sensitivity (□229) <sup>1</sup>	• ISO sensitivity: [Auto] • Minimum shutter speed: [None]
Exposure bracketing (□231) <sup>2</sup>	[Off]
AF area mode (□232) <sup>1</sup>	[Target finding AF]

Option	Default setting
<b>Autofocus mode</b> (□237)	[Full-time AF]
<b>Flash exp. comp.</b> (□238)	[0.0]
<b>Noise reduction filter</b> (□239)	[Normal]
<b>Long exposure NR</b> (□239)	[Auto]
<b>Active D-Lighting</b> (□240)	[Off]
<b>Multiple exposure</b> (□241)	<ul style="list-style-type: none"> <li>• Multiple exposure mode: [Off]</li> <li>• Auto gain: [On]</li> </ul>
<b>Save user settings</b> (□87)	—
<b>Reset user settings</b> (□88)	—
<b>Zoom memory</b> (□243)	[Off]
<b>Startup zoom position</b> (□245)	[24 mm]
<b>M exposure preview</b> (□245)	[Off]

- 1 Also can be set by pressing the Fn (function) button (□149).
- 2 Cannot be set in **M** mode.



## The Movie manual mode menu

Rotate the mode dial to  (Movie manual) ➔ MENU button

Option	Default setting
Exposure mode (M183)	[Aperture-priority auto]
Picture Control (M213)	[Standard]
Custom Picture Control (M217)	—
White balance (M219)	[Auto (normal)]
ISO sensitivity (M229)	<ul style="list-style-type: none"><li>• ISO sensitivity: [Auto]</li><li>• Minimum shutter speed: [None]</li></ul>

## The movie menu

Shooting mode ➡ MENU button ➡  (movie menu) ➡  button

Option	Default setting
Movie options (M247)	 [1080/30p] or  [1080/25p]
Autofocus mode (M251)	[Single AF]
Electronic VR (M252)	[On]
Wind noise reduction (M252)	[Off]
Zoom microphone (M253)	[On]
Frame rate (M254)	—
External mic sensitivity (M254)*	[Auto sensitivity]

\* This option can be set only when an external microphone is connected.

# The playback menu

 button (playback mode) ➡ MENU button

## Option

**Mark for upload (□□256)**

---

**Quick retouch (□□257)\***

---

**D-Lighting (□□258)\***

---

**Skin softening (□□259)\***

---

**Filter effects (□□260)\***

---

**Slide show (□□263)**

---

**Protect (□□264)**

---

**Rotate image (□□266)**

---

**Small picture (□□268)\***

---

**Sequence display options (□□269)**

---

**Choose key picture (□□269)**

---

\* Edited images are saved as separate files. Some images may not be edited.

## The network menu

MENU button →  (network menu) →  button

### Option

**Airplane mode** (⏏270)

---

**Choose connection** (⏏270)

---

**Connect to smart device** (⏏270)

---

**Connection to remote** (⏏270)

---

**Send while shooting** (⏏271)

---

**Wi-Fi** (⏏271)

---



**Bluetooth** (⏏272)

---

**Restore default settings** (⏏272)

---

# The setup menu

MENU button ➔  (setup) ➔  button

## Option

**Time zone and date (□□274)**

---

**Slot empty release lock (□□276)**

---

**Monitor settings (□□277)**

---

**EVF auto toggle (□□281)**

---

**Date stamp (□□281)**

---

**Self-timer: after release (□□282)**

---

**Vibration reduction (□□283)\***

---

**AF assist (□□284)**

---

**Digital zoom (□□285)**

---

**Assign side zoom control (□□285)**

---

**Snap-back zoom (□□286)**

---

**Control ring options (□□286)**

---

**AE/AF lock button (□□287)**

---

**Sound settings (□□288)**

---

**Auto off (□□289)**

---

**Format card (□□289)**

---

**Language (□□289)**

---

**HDMI (□□290)**

---

Option
<b>Charge by computer (□□292)</b>
<b>Image comment (□□294)</b>
<b>Copyright information (□□295)</b>
<b>Location data (□□296)</b>
<b>Toggle Av/Tv selection (□□297)</b>
<b>Reset file numbering (□□297)</b>
<b>Peaking (□□298)</b>
<b>Reset all (□□299)</b>
<b>Conformity marking (□□299)</b>
<b>Firmware version (□□300)</b>

\* Also can be set by pressing the Fn (function) button (□□149).

# The shooting menu (common across shooting modes)

## Image quality

Shooting mode\* ➔ MENU button ➔ Image quality ➔  button

- \* The image quality can be set in any shooting mode other than Movie manual. The setting is also applied to other shooting modes (except shooting mode **U** and [**Easy panorama**] scene mode).

Set the image quality (compression ratio) used when saving images. Lower compression ratios result in higher quality images, but the number of images that can be saved is reduced.

Option	Description
<b>FINE Fine</b>	Finer image quality than [ <b>Normal</b> ]. Compression ratio of about 1:4
<b>NORM Normal (default setting)</b>	Normal image quality, suitable for most applications. Compression ratio of about 1:8
<b>RAW RAW</b>	Raw data from the image sensor are saved without additional processing. You can use a computer to change settings that were set during shooting such as white balance and contrast. • File format: RAW (NRW), Nikon's own format
<b>RAW-F RAW + Fine</b>	Two images are recorded at the same time, one RAW image and one fine-quality JPEG image.
<b>RAW-N RAW + Normal</b>	Two images are recorded at the same time, one RAW image and one normal-quality JPEG image.

---

### ✔ Notes about [Image quality]

- [Image size] is fixed at  [4608×3456] when [Image quality] is set to [RAW].
- RAW images cannot be captured in the following shooting modes:
  - Creative mode
  - Bird-watching mode
  - Moon mode
  - Scene modes

If you change the shooting mode to any of the above shooting modes when a RAW image quality has been selected, the image quality will change to [Fine] or [Normal].

- This function may not be available to use in combination with other functions (156).
-

---

**Tip: RAW images of this camera**

- RAW processing and image editing cannot be performed on this camera. If you download RAW images to a computer, you can use the software “NX Studio” to perform RAW processing and image editing. See “Transferring images to a computer” (□312) for information about downloading images. To use the software, see the online help.
- To print RAW images, download them to a computer and use “NX Studio”.

**Tip: Saving of RAW and JPEG images at the same time**

- The RAW image and the JPEG image that are saved at the same time have the same file number but with their own extensions, “.NRW” and “.JPG” respectively.
- When playing back on the camera, only the JPEG image is displayed.
- Note that when the JPEG image is deleted, the RAW image that was saved at the same time is also deleted.

**Tip: Number of images that can be saved**

- The approximate number of images that can be saved can be checked on the screen when shooting.









- Note that due to JPEG compression, the number of images that can be saved may vary greatly depending on the image content, even when using memory cards with the same capacity and the same image quality and image size settings. In addition, the number of images that can be saved may vary depending on the make of the memory card.
  - If the number of exposures remaining is 10,000 or more, the number of exposures remaining display shows “9999”.
-

## Image size

Shooting mode\* ➔ MENU button ➔ Image size ➔  button

- \* The image size can be set in any shooting mode other than Movie manual. The setting is also applied to other shooting modes (except shooting mode **U**, [**Easy panorama**] scene mode, and [**Superlapse movie**]).

Set the image size (number of pixels) used when saving JPEG images. The larger the image size, the larger the size at which it can be printed, but the number of images that can be saved is reduced.

Option*	Aspect ratio (horizontal to vertical)
 <b>4608×3456</b> (default setting)	4:3
 <b>3264×2448</b>	4:3
 <b>2272×1704</b>	4:3
 <b>1600×1200</b>	4:3
 <b>4608×2592</b>	16:9
 <b>4608×3072</b>	3:2
 <b>3456×3456</b>	1:1

- \* The numerical values indicate the number of pixels that are captured. Example:  4608×3456 = approx. 16 megapixels, 4608 × 3456 pixels

### Notes about [Image size]

This function may not be available to use in combination with other functions ().

## The shooting menu (P, S, A, M, or U mode)





See “U (user settings) mode” (□87) for information about [Save user settings] and [Reset user settings].

### Picture Control

Rotate the mode dial to **P, S, A, M, or U\*** ➔ MENU button ➔  
Picture Control ➔  button

\* The setting can also be configured in  (Movie manual) mode.

You can use Picture Control (COOLPIX Picture Control) to change the settings for image recording according to the shooting conditions or your preferences. Sharpness, contrast and saturation can be adjusted in detail.

Option	Description
 <b>SD Standard (default setting)</b>	Standard processing for balanced results. Recommended for most situations.
 <b>NL Neutral</b>	Minimal processing for natural results. Select for images that will later be processed or retouched.
 <b>V Vivid</b>	Images are enhanced for a vivid, photoprint effect. Select for images that emphasize primary colors, such as blue, red, and green.
 <b>MC Monochrome</b>	Shoots monochrome photographs such as in black-and-white or sepia.
 <b>Custom 1*</b>	Changes to the setting of [Custom 1] in COOLPIX Custom Picture Control.

Option	Description
 <b>Custom 2*</b>	Changes to the setting of [Custom 2] in COOLPIX Custom Picture Control.

- \* Only displayed when the setting customized in [Custom Picture Control] (□217) has been registered.

### ✓ Notes about COOLPIX Picture Control

- The COOLPIX Picture Control function of this camera cannot be used with other makes of cameras, Picture Control function of software such as NX Studio, Picture Control Utility 2, etc.
- This function may not be available to use in combination with other functions (□156).

## ■ Customizing existing COOLPIX Picture Controls: Quick adjust and manual adjust

COOLPIX Picture Control can be customized using “Quick adjust”, which allows for balanced adjustment of sharpness, contrast, saturation and other image editing components, or using “Manual adjust”, which allows for detailed adjustment of the components individually.

### 1 Use the multi selector ▲▼ to select the desired type of COOLPIX Picture Control and press the button.

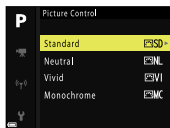

- Items can also be selected by rotating the multi selector.

## 2 Use ▲▼ to highlight the desired option and use ◀▶ to select a value.

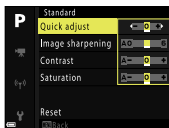

- For adjustment options, see “Types of quick adjust and manual adjust” (□□215).
- Press the **OK** button to set the value.
- To change the adjusted values to the default setting, select [**Reset**] and press the **OK** button.

### ■ Types of quick adjust and manual adjust

Option	Description
<b>Quick adjust<sup>1</sup></b>	Adjusts the sharpness, contrast and saturation levels automatically. Setting to the – side reduces the effect of the selected COOLPIX Picture Control, and setting to the + side emphasizes its effect. • Default setting: [0]
<b>Image sharpening</b>	Controls how much outlines are sharpened during shooting. The higher the number, the sharper the image, and the lower the number, the softer the image. Select [ <b>A</b> ] (auto) for automatic adjustment. • Default setting: [3] for [ <b>Standard</b> ] or [ <b>Monochrome</b> ], [2] for [ <b>Neutral</b> ], and [4] for [ <b>Vivid</b> ]

Option	Description
<b>Contrast</b>	<p>Controls the contrast.</p> <p>Setting to the – side gives the image a softer appearance, and setting to the + side gives it a harder appearance. Select lower values to prevent highlights in portrait subjects from being “washed out” in direct sunlight, higher values to preserve detail in misty landscapes and other low contrast subjects.</p> <p>Select <b>[A]</b> (auto) for automatic adjustment.</p> <ul style="list-style-type: none"> <li>• Default setting: <b>[0]</b></li> </ul>
<b>Saturation<sup>2</sup></b>	<p>Controls the vividness of colors.</p> <p>Setting to the – side reduces the vividness, and setting to the + side increases the vividness.</p> <p>Select <b>[A]</b> (auto) for automatic adjustment.</p> <ul style="list-style-type: none"> <li>• Default setting: <b>[0]</b></li> </ul>
<b>Filter effects<sup>3</sup></b>	<p>Simulates the effect of color filters on monochrome photographs.</p> <ul style="list-style-type: none"> <li>• <b>[OFF]</b>: Filter effects are not used.</li> <li>• <b>[Y]</b> (yellow), <b>[O]</b> (orange), <b>[R]</b> (red): Enhance contrast. Can be used to tone down the brightness of the sky in landscape photographs. The contrast is strengthened in the order <b>[Y] → [O] → [R]</b>.</li> <li>• <b>[G]</b> (green): Softens skin tones and the color of features such as lips. Suitable for portraits.</li> <li>• Default setting: <b>[OFF]</b></li> </ul>

Option	Description
<b>Toning<sup>3</sup></b>	<p>Controls the tint used in monochrome photographs from <b>[B&amp;W]</b> (black-and-white), <b>[Sepia]</b>, and <b>[Cyanotype]</b> (blue-tinted monochrome).</p> <p>Pressing the multi selector ▼ when <b>[Sepia]</b> or <b>[Cyanotype]</b> is selected enables you to select a saturation level. Press ◀▶ to adjust the saturation.</p> <ul style="list-style-type: none"> <li>• Default setting: <b>[B&amp;W]</b> (black-and-white)</li> </ul>

- 1 Quick adjust is not available in **[Neutral]**, **[Monochrome]**, **[Custom 1]**, and **[Custom 2]**.  
The values set manually are disabled if quick adjust is used after manual setting.
- 2 Not displayed for **[Monochrome]**.
- 3 Only displayed for **[Monochrome]**.

### ✔ Notes about **[Image sharpening]**

The effects of **[Image sharpening]** cannot be previewed on the screen during shooting. Check the results in playback mode.

### ✔ Notes about **[A] (auto)** in **[Contrast]** and in **[Saturation]**

Results for contrast and saturation vary with the exposure, and the position and size of the subject in the frame.

## Custom Picture Control

Rotate the mode dial to **P, S, A, M,** or **U\*** ➔ MENU button ➔  
Custom Picture Control ➔  button

\* The setting can also be configured in  (Movie manual) mode.

In Custom Picture Control (COOLPIX Custom Picture Control) (214), customize the settings of **[Picture Control]** and register them in **[Custom 1]** or **[Custom 2]**.

- 
- 1 Use the multi selector ▲▼ to select [Edit and save], and press the OK button.**

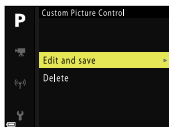

- Select [**Delete**] to delete a registered COOLPIX Custom Picture Control.

- 
- 2 Select the original COOLPIX Picture Control to be edited, and press the OK button.**

- 3 Use ▲▼ to highlight the desired option and use ◀▶ to select a value.**

- The options are the same as those for adjusting the COOLPIX Picture Control.
- Press the OK button when you finish adjustment.
- To change the adjusted values to the default setting, select [**Reset**] and press the OK button.

## 4 Select the registration destination and press the **OK** button.

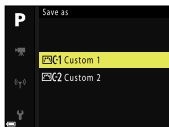

- [**Custom 1**] or [**Custom 2**] becomes selectable in [**Picture Control**].
- To change the adjusted values, select [**Custom 1**] or [**Custom 2**] in [**Picture Control**].





## White balance

Rotate the mode dial to **P, S, A, M,** or **U\*** → MENU button →  
White balance → **OK** button

\* The setting can also be configured in **M** (Movie manual) mode.

Adjust white balance to suit the light source or weather conditions in order to make the colors in images match what you see with your eyes.

Option	Description
<b>AUTO1 Auto (normal)</b> (default setting)	White balance is automatically adjusted. When set to [ <b>Auto (warm lighting)</b> ], the images are preserved with warm colors if they are shot under an incandescent light source. When using the flash, white balance is adjusted according to the flash lighting condition.
<b>AUTO2 Auto (warm lighting)</b>	
<b>PRE Preset manual</b>	Use when the desired result is not achieved with [ <b>Auto (normal)</b> ], [ <b>Auto (warm lighting)</b> ], [ <b>Incandescent</b> ], etc. (☐221).
<b>☀ Daylight*</b>	Use under direct sunlight.

Option	Description
 <b>Incandescent*</b>	Use under incandescent lighting.
 <b>Fluorescent</b>	Use under most types of fluorescent lighting. Choose one of [1] (cool-white fluorescent), [2] (day white fluorescent), and [3] (daylight fluorescent).
 <b>Cloudy*</b>	Use under overcast skies.
 <b>Flash*</b>	Use with the flash.
 <b>Choose color temp.</b>	Use to directly specify color temperature (□221).

\* Fine adjustments in seven steps are available. Apply positive (+) to increase blue hue and negative (-) to increase red hue.

#### **Notes about [White balance]**

- Lower the built-in flash when white balance is set to any setting other than [**Auto (normal)**], [**Auto (warm lighting)**], or [**Flash**].
- This function may not be available to use in combination with other functions (□156).

---

## Tip: White balance indicator on the shooting screen

 **AWB**, which indicates **[Auto (normal)]**, is displayed only immediately after setting using the **Fn** button.

## Tip: Color temperature

Color temperature is an objective measure of colors of light sources which are expressed in the unit of absolute temperature (K: Kelvin). Light sources with lower color temperature values appear more reddish, while light sources with higher color temperature values appear more bluish.

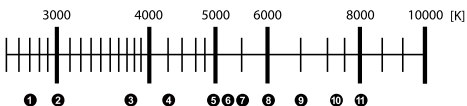

- ①: Sodium-vapor lamps: 2700K
- ②: Incandescent/Warm-white fluorescent: 3000K
- ③: White fluorescent: 3700K
- ④: Cool-white fluorescent: 4200K
- ⑤: Day white fluorescent: 5000K
- ⑥: Direct sunlight: 5200K
- ⑦: Flash: 5400K
- ⑧: Cloudy: 6000K
- ⑨: Daylight fluorescent: 6500K
- ⑩: High temp. mercury-vapor: 7200K
- ⑪: Shade: 8000K

---

## ■ Using Preset manual

Follow the procedures described below to measure the white balance value under the lighting used during shooting.

- 1 Place a white or gray reference object under the lighting that will be used during shooting.**

- 2** Use the multi selector ▲▼ to select [Preset manual], and press the **OK** button.

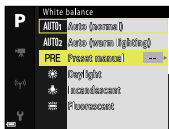

- The lens extends to the zoom position for measurement.

- 3** Select [Measure].



- To apply the last measured value, select [**Cancel**] and press the **OK** button.

- 4** Frame the white or gray reference object in the measuring window (1), and press the **OK** button to measure the value.

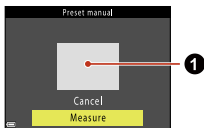

- The shutter is released and measurement is complete (no image is saved).

## ✔ Notes about [Preset manual]



A white balance value for flash lighting cannot be measured with [Preset manual]. When shooting using the flash, set [White balance] to [Auto (normal)], [Auto (warm lighting)], or [Flash].

## Metering

Rotate the mode dial to **P, S, A, M, or U** → MENU button → Metering →  button

The process of measuring the brightness of the subject to determine the exposure is known as “metering.”

Use this option to set the method of how the camera meters exposure.

Option	Description
 <b>Matrix (default setting)</b>	The camera uses a wide area of the screen for metering. Recommended for typical shooting.
 <b>Center-weighted</b>	The camera meters the entire frame but assigns greatest weight to the subject in the center of the frame. The classic metering for portraits; it preserves background details while letting lighting conditions in the center of the frame determine exposure.*
 <b>Spot</b>	The camera meters the area shown by the circle in the center of the frame. This can be used when the subject is much lighter or darker than the background. Ensure that the subject is within the area shown by the circle when shooting.*

\* To set focus and exposure for off-center subjects, change [AF area mode] to manual and set the focus area to the center of the frame, and then use focus lock (138).

## ✔ Notes about [Metering]

- When digital zoom is in effect, [**Center-weighted**] or [**Spot**] is selected depending on the zoom ratio.
- This function may not be available to use in combination with other functions (☐156).



## Tip: Display on the shooting screen





When [**Center-weighted**] or [**Spot**] is selected, the metering range guide is displayed (except when digital zoom is used).

## Continuous

Rotate the mode dial to **P, S, A, M,** or **U** ➔ MENU button ➔ Continuous ➔  
OK button

Set single or continuous shooting.

Option	Description
 <b>Single</b> (default setting)	One image is captured each time the shutter-release button is pressed.
 <b>Continuous</b> <b>H</b>	While the shutter-release button is held all the way down, images are captured continuously. <ul style="list-style-type: none"><li>• The camera can capture up to about 7 images continuously at a rate of about 7 fps.</li></ul>
 <b>Continuous</b> <b>L</b>	While the shutter-release button is held all the way down, images are captured continuously. <ul style="list-style-type: none"><li>• The camera can capture up to about 200 images continuously at a rate of about 1 fps.</li></ul>

Option	Description
 <b>Pre-shooting cache</b>	<p>Pre-shooting cache shooting begins when the shutter-release button is pressed halfway. When the shutter-release button is pressed all the way down, the camera saves the current image as well as the images captured immediately before the button is pressed (□□227). Pre-shooting cache makes it easy to capture perfect moments.</p> <ul style="list-style-type: none"> <li>• The camera can capture up to about 20 images continuously at a rate of about 15 fps (including a maximum of 5 images captured in the pre-shooting cache).</li> <li>• The image quality is fixed at [Normal] and the image size is fixed at L<sup>M</sup> (1280 × 960 pixels).</li> </ul>
 <b>Continuous H: 120 fps</b>	<p>Each time the shutter-release button is pressed all the way down, images are captured continuously at a high speed rate.</p> <ul style="list-style-type: none"> <li>• The camera can capture up to about 60 images continuously at a rate of about 120 fps.</li> <li>• Image size is fixed at V<sup>GA</sup> (640 × 480 pixels).</li> </ul>
 <b>Continuous H: 60 fps</b>	<p>Each time the shutter-release button is pressed all the way down, images are captured continuously at a high speed rate.</p> <ul style="list-style-type: none"> <li>• The camera can capture up to about 60 images continuously at a rate of about 60 fps.</li> <li>• Image size is fixed at H<sup>S</sup> (1920 × 1080 pixels).</li> </ul>
 <b>Intvl timer shooting</b>	<p>The camera automatically captures still images continuously at the specified interval (□□228).</p>

---

## ✔ Notes about [Continuous]

- Focus and exposure are fixed at the values determined with the first shot in each series. White balance is also fixed at the value determined with the first shot in each series, except when using [**Continuous L**] or [**Intvl timer shooting**].
  - It may take some time to save the images after shooting or to perform the next operation.
  - When ISO sensitivity increases, noise may appear in captured images.
  - The frame rate may become slower depending on the image quality, image size, memory card type or shooting conditions (such as when saving RAW images).
  - When using [**Continuous H: 120 fps**] or [**Continuous H: 60 fps**], banding or variance in brightness or hue may occur in images that were captured under lighting that flashes quickly at high speeds, such as fluorescent, mercury-vapor, or sodium-vapor lighting.
  - This function may not be available to use in combination with other functions (☐156).
-

---

## Tip: Pre-shooting cache

When the shutter-release button is pressed halfway or all the way down, images are saved as described below.

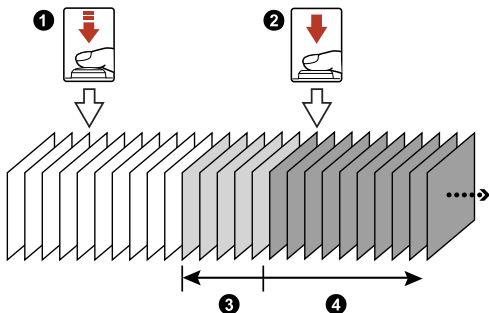

❶: Press down halfway

❷: Press down all the way

❸: Images saved before pressing all the way

❹: Images saved by pressing all the way

- The pre-shooting cache icon (📷) on the shooting screen changes to green while the shutter-release button is pressed halfway.
-

## Interval timer shooting

Rotate the mode dial to **P**, **S**, **A**, **M**, or **U** → MENU button → Continuous →  
OK button → Intvl timer shooting → OK button

### 1 Set the desired interval between each shot.



- Use ◀▶ to select an item, and use ▲▼ to set the time.
- Press the OK button when setting is complete.

### 2 Press the MENU (menu) button to display the shooting screen.

### 3 Press the shutter-release button to shoot the first image.



- The shutter is automatically released at the specified interval to shoot second and subsequent images.
- The screen turns off and the power-on lamp flashes during the intervals between shots.

## 4 When the desired number of images have been captured, press the shutter-release button.

- Shooting ends.
- Shooting ends automatically in the following situations:
  - When the memory card becomes full
  - When 9999 shots are taken in sequence

### ✓ Notes about [Intvl timer shooting]

- To prevent the camera from turning off unexpectedly during shooting, use a sufficiently charged battery.
- If the EH-5d AC Adapter and the EP-5C Power Connector (both available separately) (□320) are used, this camera can be powered from an electrical outlet. Do not, under any circumstances, use an AC adapter other than the EH-5d. Failure to observe this precaution could result in overheating or damage to the camera.
- Do not rotate the mode dial to a different setting while interval timer shooting is in progress. Doing so causes the camera to stop shooting.
- If the shutter speed is slow and saving an image takes time compared to the specified interval, some of the shots during Interval timer shooting may be canceled.

## ISO sensitivity

Rotate the mode dial to **P, S, A, M,** or **U\*** ➔ MENU button ➔

ISO sensitivity ➔ 

\* The setting can also be configured in  (Movie manual) mode.

A higher ISO sensitivity allows darker subjects to be captured.

Additionally, even with subjects of similar brightness, pictures can be taken at faster shutter speeds, and blurring caused by camera shake and subject movement can be reduced.





- When a higher ISO sensitivity is set, images may contain noise.

Option	Description
<b>ISO sensitivity</b>	<ul style="list-style-type: none"> <li>• <b>[Auto]</b> (default setting): Sensitivity is automatically set within the range of ISO 100 to 1600. In Movie manual mode, it is set within the range of ISO 125 to 1600.</li> <li>• <b>[Fixed range auto]</b>: The range in which the camera automatically adjusts ISO sensitivity can be set to <sup>ISO AUTO</sup>400 <b>[ISO 100-400]</b> or <sup>ISO AUTO</sup>800 <b>[ISO 100-800]</b>. In Movie manual mode, it can be set to <sup>ISO AUTO</sup>400 <b>[ISO 125-400]</b> or <sup>ISO AUTO</sup>800 <b>[ISO 125-800]</b>.</li> <li>• <b>[100]</b> to <b>[6400]</b> (<b>[125]</b> to <b>[6400]</b> in Movie manual mode): ISO sensitivity is fixed at the specified value.</li> </ul>
<b>Minimum shutter speed</b>	<p>Set the shutter speed at which ISO sensitivity starts to be automatically adjusted when the shooting mode is <b>P</b> or <b>A</b>. If the exposure is insufficient with the shutter speed that is set here, the ISO sensitivity is increased automatically to obtain the optimal exposure.</p> <ul style="list-style-type: none"> <li>• The setting is enabled when <b>[ISO sensitivity]</b> is set to <b>[Auto]</b> or <b>[Fixed range auto]</b>.</li> <li>• If the exposure is still insufficient even after ISO sensitivity is increased, the shutter speed slows down.</li> <li>• Default setting: <b>[None]</b></li> </ul>

### ✔ Notes about [ISO sensitivity]

- When **[ISO sensitivity]** is set to **[Auto]** or **[Fixed range auto]** in **M** (manual) mode, the ISO sensitivity is fixed at ISO 100.
- When **[Manual]** is selected for **[Exposure mode]** in Movie manual mode and **[ISO sensitivity]** is set to **[Auto]** or **[Fixed range auto]**, the ISO sensitivity is fixed at ISO 125.
- This function may not be available to use in combination with other functions (□156).

### Tip: ISO sensitivity display on the shooting screen

- When **[Auto]** is selected in **P, S, A,** and **U** modes,  is displayed only when the ISO sensitivity increases. When **[Fixed range auto]** is selected,  and the maximum value for ISO sensitivity are displayed.
- In **P, S, A, M, U,** and Movie manual modes,  and the setting value are displayed if the ISO sensitivity is fixed.
- If the shooting mode is not **P, S, A, M,** or **U,** and  is displayed, the ISO sensitivity is automatically set and the maximum value for ISO sensitivity is displayed.
- In all other shooting modes,  is displayed only when the sensitivity increases.

## Exposure bracketing

Rotate the mode dial to **P, S,** or **A** ➔ MENU button ➔

Exposure bracketing ➔  button

The exposure (brightness) can be changed automatically during continuous shooting. This is effective for shooting when it is difficult to adjust the picture brightness.

Option	Description
<b>Off</b> <b>(default setting)</b>	Exposure bracketing is not performed.
<b>±0.3</b>	When the shutter-release button is pressed all the way, 3 shots are taken in sequence and the camera varies exposure by 0, -0.3, and +0.3 over the shots.
<b>±0.7</b>	When the shutter-release button is pressed all the way, 3 shots are taken in sequence and the camera varies exposure by 0, -0.7, and +0.7 over the shots.

Option	Description
±1.0	When the shutter-release button is pressed all the way, 3 shots are taken in sequence and the camera varies exposure by 0, -1.0, and +1.0 over the shots.

### ✓ Notes about [Exposure bracketing]







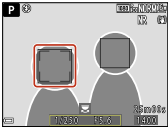
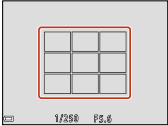

- [Exposure bracketing] is not available in **M** (manual) mode.
- When exposure compensation and [±0.3], [±0.7], or [±1.0] in [Exposure bracketing] are set simultaneously, the combined exposure compensation values are applied.
- This function may not be available to use in combination with other functions (☐156).

## AF area mode

Rotate the mode dial to **P, S, A, M**, or **U** ➔ MENU button ➔ AF area mode ➔  button

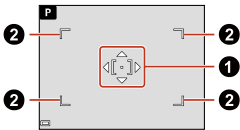
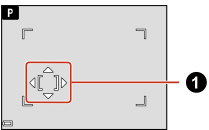
Set how the camera selects the focus area for autofocus.

Option	Description
<p data-bbox="104 423 194 489"><b>Face priority</b></p>	<p data-bbox="256 107 884 176">When the camera detects a human face, it focuses on that face (□136).</p>  <p data-bbox="256 428 921 562">When framing a composition with no human subjects or detected faces, the camera automatically selects one or more of the nine focus areas containing the subject closest to the camera when the shutter-release button is pressed halfway.</p> 

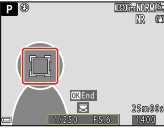
Option	Description
<p>[  ] <b>Manual (spot)</b>  [  ] <b>Manual (normal)</b>  [  ] <b>Manual (wide)</b></p>	<p>Use the multi selector  or rotate it to move the focus area (1) to where you want to focus.</p> <p>You can move it within the range of the movable area guide (2).</p> <ul style="list-style-type: none"> <li>• When at the center</li> </ul>  <ul style="list-style-type: none"> <li>• When moving</li> </ul>  <p>To use the multi selector to configure the flash mode or other settings, press the  button. To return to moving the focus area, press the  button again.</p>
<p> <b>Subject tracking</b></p>	<p>Use this function to take pictures of moving subjects. Register the subject on which the camera focuses. The focus area automatically moves to track the subject (□□236).</p> 

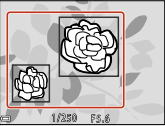
Option	Description
<p data-bbox="104 195 228 331">[<b>AF</b>] Target finding AF (default setting)</p>	<p data-bbox="256 110 912 176">When the camera detects the main subject, it focuses on the subject (☐134).</p> 

### ✓ Notes about [AF area mode]

- When digital zoom is in effect, the camera focuses on the area in the center of the frame regardless of the [AF area mode] setting.
- When the focus-mode selector is set to **MF** (manual focus), [AF area mode] cannot be set.
- This function may not be available to use in combination with other functions (☐156).

### Tip: [AF area mode] in bird-watching mode

If you press the MENU button in bird-watching mode, you can set [AF area mode] to [Center (spot)] (default setting), [Center (normal)], or [Center (wide)]. Set according to the size of the subject and the focus range.

## ■ Using subject tracking

Rotate the mode dial to **P**, **S**, **A**, **M**, or **U** → MENU button → AF area mode →  
OK button → Subject tracking → OK button → MENU button

### 1 Register a subject.

- Align the subject that you want to track with the border in the center of the frame and press the OK button.



- When the subject is registered, a yellow border (focus area) is displayed around it and the camera begins tracking the subject.



- If the subject cannot be registered, the border is displayed in red. Change the composition and try registering the subject again.
- To cancel subject registration, press the OK button.
- If the camera can no longer track the registered subject, the focus area disappears. Register the subject again.

## 2 Press the shutter-release button all the way to take the picture.

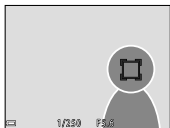

- If the shutter-release button is pressed while the focus area is not displayed, the camera focuses on the subject in the center of the frame.

### ✓ Notes about [Subject tracking]

- If you perform operations such as zooming while the camera is tracking the subject, the registration is canceled.
- Subject tracking may not be possible in certain shooting conditions.

## Autofocus mode

Rotate the mode dial to **P, S, A, M,** or **U** ➔ MENU button ➔  
Autofocus mode ➔ 

Set how the camera focuses when shooting still images.

Option	Description
AF-S Single AF	The camera focuses only when the shutter-release button is pressed halfway.
AF-F Full-time AF (default setting)	The camera always focuses even if the shutter-release button is not pressed halfway. The sound of lens drive movement is heard while the camera focuses.

## ✔ Notes about [Autofocus mode]

- When the focus-mode selector is set to **MF** (manual focus), [Autofocus mode] cannot be set.
- This function may not be available to use in combination with other functions (☐156).

## Tip: Autofocus mode for movie recording

Autofocus mode for movie recording can be set in the movie menu → [Autofocus mode] (☐251).

## Flash exp. comp.

Rotate the mode dial to **P, S, A, M,** or **U** → MENU button →  
Flash exp. comp. → 

Adjust the flash output.

Use this option when the flash is too bright or too dark.

- If the compensation value you want to set is not displayed on the setting screen, press the multi selector ▲▼ until it is displayed.

Option	Description
+0.3 to +2.0	The flash output is increased from +0.3 to +2.0 EV, in increments of 1/3 EV, to make the main subject of the frame appear brighter.
0.0 (default setting)	The flash output is not adjusted.
-0.3 to -2.0	The flash output is reduced from -0.3 to -2.0 EV, in increments of 1/3 EV, to prevent unwanted highlights or reflections.

## Noise reduction filter

Rotate the mode dial to **P, S, A, M,** or **U** → MENU button →

Noise reduction filter →  button

Set the strength of the noise reduction function that is normally performed when saving images.

Option	Description
<b>NR<sup>+</sup> High</b>	Performs noise reduction at a level higher than the standard strength.
<b>NR Normal (default setting)</b>	Performs noise reduction at the standard strength.
<b>NR<sup>-</sup> Low</b>	Performs noise reduction at a level lower than the standard strength.

## Long exposure NR

Rotate the mode dial to **P, S, A, M,** or **U** → MENU button →

Long exposure NR →  button

Reduce “noise” (bright spots or fog) in photos taken at slow shutter speeds.

Option	Description
 <b>Auto (default setting)</b>	Reduce noise if the shutter speed is 1/4 of a second or slower.
<b>OFF</b>	Do not reduce noise.

## Active D-Lighting

Rotate the mode dial to **P**, **S**, **A**, **M**, or **U** → MENU button →

Active D-Lighting →  button

Details in highlights and shadows are preserved, and the natural contrast that is seen with the naked eye is well reproduced in the image captured. This is particularly effective for shooting conditions with high contrast, such as brightly lit outdoor scenery from a dark room or shaded subjects at a sunny seaside.

Option	Description
<b>☺ H High</b> <b>☺ N Normal</b> <b>☺ L Low</b>	Set the effect level.
<b>OFF Off</b> <b>(default setting)</b>	Active D-Lighting is not applied.

### ✔ Notes about [Active D-Lighting]

- Additional time is required to save images after shooting.
- When using [Active D-Lighting], noise (randomly-spaced bright pixels, fog, lines) may be emphasized, dark shadows may appear around bright subjects, or bright areas may appear around dark subjects under some shooting conditions.
- When using [Active D-Lighting], gradation skipping may occur depending on the subject.
- This function may not be available to use in combination with other functions (□156).

---

**Tip: [Active D-Lighting] versus [D-Lighting]**

- The [**Active D-Lighting**] option captures images while reducing loss of details in highlights, and adjusts the tone when saving images.
  - The playback menu → [**D-Lighting**] option adjusts the tone of saved images (□258).
- 

## Multiple exposure

Rotate the mode dial to **P, S, A, M,** or **U** → MENU button →

Multiple exposure → Ⓞ button

The camera combines two to three images and saves them as a single image.

Option	Description
<b>Multiple exposure mode</b>	Shoots images in multiple exposure mode when set to [ <b>On</b> ]. <ul style="list-style-type: none"><li>• Individual images are also saved.</li><li>• Default setting: [<b>Off</b>]</li></ul>
<b>Auto gain</b>	Set whether or not to automatically adjust the brightness of the image when combining images. <ul style="list-style-type: none"><li>• Default setting: [<b>On</b>]</li></ul>

---

**✓ Notes about [Multiple exposure]**

- It may take some time to combine images.
  - Multiple exposure is terminated if the [**Auto off**] function (□289) triggers the standby mode during shooting. When shooting with a long interval between shots, setting a longer time for the auto off function is recommended.
  - This function may not be available to use in combination with other functions (□156).
  - When shooting at a slow shutter speed in multiple exposure mode, noise (bright spots) may appear in saved images.
-

## ■ Multiple exposure shooting

---

- 1** In [Multiple exposure mode], select [On], and press the **OK** button.



- After setting, press the MENU (menu) button to return to the shooting screen.

- 2** Press the shutter-release button to shoot the first image.



### 3 Press the shutter-release button to shoot the second image.



- Frame the picture while looking at the first image displayed translucently.
- When shooting the second image, the combined image of the first and second images is saved, and displayed translucently.
- To end multiple exposure at the second image, set [**Multiple exposure mode**] to [**Off**] or change the mode dial to any mode other than **P**, **S**, **A**, **M**, or **U**.

### 4 Press the shutter-release button to shoot the third image.

- The combined image of the first to third images is saved and multiple exposure ends.
- It may take some time until the third image is shot.

## Zoom memory

Rotate the mode dial to **P**, **S**, **A**, **M**, or **U** ➔ MENU button ➔

Zoom memory ➔ 

When the zoom control is moved, the zoom position (equivalent to focal length/angle of view in 35mm [135] format) is switched to the positions that have been selected by setting the check box to on in this menu option.

Option	Description
On	<ul style="list-style-type: none"> <li>• Choose the focal length with the multi selector ▲▼, and then press the <b>OK</b> button to set the check box to on [✓] or off. The following settings are available: [24 mm], [28 mm], [35 mm], [50 mm], [70 mm], [85 mm], [105 mm], [135 mm], [200 mm], [300 mm], [400 mm], [500 mm], [600 mm], [800 mm], [1000 mm], [1200 mm], [1400 mm], [1600 mm], [1800 mm], [2000 mm], [2200 mm], [2400 mm], [2600 mm], [2800 mm], and [3000 mm].</li> <li>• Default setting: On [✓] for all the check boxes</li> <li>• To finish setting, press the multi selector ►.</li> <li>• The zoom position set in the [<b>Startup zoom position</b>] is automatically set to on [✓].</li> <li>• The zoom memory function cannot be used with the side zoom control.</li> </ul>
Off (default setting)	The zoom position can be moved to any position, including the positions that can be set with [On].

### ✓ Notes about zoom operation

- When more than one focal length has been set, move the zoom control to switch to the focal length closest to that before the operation. To switch to a different focal length, release the zoom control and then move it again.
- Set [**Zoom memory**] to [Off] when using the digital zoom.

## Startup zoom position

Rotate the mode dial to **P, S, A, M,** or **U** ➔ MENU button ➔

Startup zoom position ➔  button

Set the zoom position (equivalent to focal length/angle of view in 35mm [135] format) for when the camera is turned on.

The following settings are available: [**24 mm**] (default setting), [**28 mm**], [**35 mm**], [**50 mm**], [**70 mm**], [**85 mm**], [**105 mm**], and [**135 mm**].

## M exposure preview

Rotate the mode dial to **P, S, A, M,** or **U** ➔ MENU button ➔

M exposure preview ➔  button

Set whether or not to reflect the brightness to the shooting screen when the exposure is changed in **M** (manual) mode.

Option	Description
<b>On</b>	Reflects the brightness to the shooting screen.
<b>Off</b> <b>(default setting)</b>	Does not reflect the brightness to the shooting screen.

## The Movie manual mode menu

You can set the following menu options. See each page for more information.

- Exposure mode (☞183)
- Picture Control (☞213)
- Custom Picture Control (☞217)
- White balance (☞219)
- ISO sensitivity (☞229)

# The movie menu

## Movie options





Shooting mode ➡ MENU button ➡  (movie menu) ➡  button ➡







Movie options ➡ 

Select the desired movie option to record. Select normal speed movie options to record at normal speed, or HS movie options to record in slow or fast motion. The options that can be selected vary depending on [Frame rate] (254).

- Memory cards with an SD Speed Class rating of 6 (Video Speed Class V6) or faster are recommended for recording movies. When [Movie options] is set to [2160/30p] (4K UHD) or [2160/25p] (4K UHD), memory cards with a UHS Speed Class rating of 3 (Video Speed Class V30) or faster are recommended.

## Normal speed movie options

Option (Image size/ Frame rate, File format)	Image size	Aspect ratio (horizontal to vertical)	Max. recording time per file (approx.)
 2160/30p (4K UHD)	3840 × 2160	16:9	6 min
 2160/25p (4K UHD)			7 min
 1080/30p (default setting)	1920×1080	16:9	29 min
 1080/25p (default setting)			29 min

Option (Image size/ Frame rate, File format)	Image size	Aspect ratio (horizontal to vertical)	Max. recording time per file (approx.)
 <b>1080/60p</b>	1920×1080	16:9	29 min
 <b>1080/50p</b>			29 min
 <b>720/30p</b>	1280×720	16:9	29 min
 <b>720/25p</b>			
 <b>720/60p</b>	1280×720	16:9	29 min
 <b>720/50p</b>			29 min

- Individual movie files cannot exceed 29 minutes in length, even when there is sufficient free space on the memory card for longer recording. The maximum size of a single movie file is 4 GB. If a file exceeds 4 GB even when you record for less than 29 minutes, it is split into multiple files and cannot be played back continuously. Recording may end before the maximum recording time is reached if the camera temperature becomes elevated.
- The actual remaining recording time may vary depending on the movie content, subject movement, or type of memory card.

## ■ HS movie options

Recorded movies are played back in fast or slow motion (☐250).

Option	Image size Aspect ratio (horizontal to vertical)	Description
120fps <b>HS 480/4×</b> 100fps <b>HS 480/4×</b>	640×480 4:3	1/4-speed slow motion movies • Max. recording time: 7 minutes 15 seconds (playback time: 29 minutes)
60fps <b>HS 720/2×</b> 50fps <b>HS 720/2×</b>	1280×720 16:9	1/2-speed slow motion movies • Max. recording time: 14 minutes 30 seconds (playback time: 29 minutes)
15fps <b>HS 1080/0.5×</b> 12.5fps <b>HS 1080/0.5×</b>	1920×1080 16:9	2× speed fast motion movies • Max. recording time: 29 minutes (playback time: 14 minutes 30 seconds)

### ✔ Notes about HS movie

- Sound is not recorded.
- Still images cannot be saved during movie recording.
- Movie recording cannot be paused.
- Zoom position, focus, exposure, and white balance are locked when movie recording starts.

---

**Tip: Playing back in slow motion and fast motion**

- When recording at normal speed

Example:

Recording time of 10 s (1)

Playback time of 10 s (2)

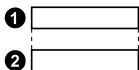

- When recording at 120fps [HS 480/4x] or 100fps [HS 480/4x]:

Movies are recorded at 4x normal speed. They are played back in slow motion at 4x slower speed.

Example:

Recording time of 10 s (1)

Playback time of 40 s (2)

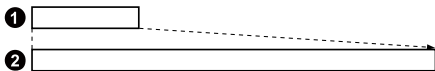

- When recording at 15fps [HS 1080/0.5x] or 12.5fps [HS 1080/0.5x]:

Movies are recorded at 1/2 normal speed. They are played back in fast motion at 2x faster speed.



Example:

Recording time of 10 s (1)

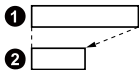
Playback time of 5 s (2)



## Autofocus mode

Shooting mode ➔ MENU button ➔  (movie menu) ➔  button ➔  
Autofocus mode ➔  button

Set how the camera focuses when recording movies.

Option	Description
<b>AF-S Single AF (default setting)</b>	Focus is locked when movie recording starts. Select this option when the distance between the camera and the subject will remain fairly consistent.
<b>AF-F Full-time AF</b>	The camera focuses continuously. Select this option when the distance between the camera and subject will change significantly during recording. The sound of the camera focusing may be heard in the recorded movie. Use of <b>[Single AF]</b> is recommended to prevent the sound of the camera focusing from interfering with recording.

### ✔ Notes about [Autofocus mode]

- When shooting in **[Superlapse movie]** scene mode, the setting is fixed at **[Single AF]**.
- When an HS movie option is selected in **[Movie options]**, the setting is fixed at **[Single AF]**.
- When the focus-mode selector is set to **MF** (manual focus), **[Autofocus mode]** cannot be set.
- This function may not be available to use in combination with other functions (156).

## Electronic VR

Shooting mode ➡ MENU button ➡  (movie menu) ➡  button ➡

Electronic VR ➡  button

Select the vibration reduction setting used when recording movies.

Option	Description
<b>On</b> <b>(default setting)</b>	Performs electronic VR. <ul style="list-style-type: none"><li>• The angle of view (i.e., the area seen in the frame) becomes narrower.</li><li>• When the setup menu ➡ <b>[Vibration reduction]</b> is set to <b>[Normal]</b>, <b>[Active]</b>, <b>[Normal (framing first)]</b>, or <b>[Active (framing first)]</b>, optical vibration reduction is performed simultaneously.</li></ul>
<b>Off</b>	Does not perform electronic VR.

### ✓ Notes about [Electronic VR]

- When shooting in **[Superlapse movie]** scene mode, the setting is fixed at **[On]**.
- When **[2160/30p]**, **[2160/25p]**, or an HS movie option is selected in **[Movie options]**, the setting is fixed at **[Off]**.

## Wind noise reduction

Shooting mode ➡ MENU button ➡  (movie menu) ➡  button ➡

Wind noise reduction ➡  button

Reduces the sound that is produced when wind passes over the microphone during movie recording.



Option	Description
<b>On</b>	Wind noise reduction is enabled.

Option	Description
<b>Off</b> (default setting)	Wind noise reduction is disabled.

### ✓ Notes about [Wind noise reduction]

- When [On] is selected, other sounds may become difficult to hear during playback.
- When shooting in [Superlapse movie] scene mode, or when an HS movie option is selected in [Movie options], the setting is fixed at [Off].

## Zoom microphone

Shooting mode ➡ MENU button ➡  (movie menu) ➡  button ➡  
Zoom microphone ➡  button

In accordance with the angle of view, the camera records sounds over a wide area at the wide-angle zoom position, and records sounds in the limited area at the telephoto zoom position.

Option	Description
<b>On</b> (default setting)	Zoom microphone is enabled.
<b>Off</b>	Zoom microphone is disabled.

### ✓ Notes about [Zoom microphone]

The setting is fixed at [Off] in the following situations:

- In [Superlapse movie] scene mode
- When an HS movie option is selected in [Movie options]
- When an external microphone is connected



## Frame rate

Shooting mode ➔ MENU button ➔  (movie menu) ➔  button ➔  
Frame rate ➔  button

Select the frame rate used when recording movies. When the frame rate setting is switched, options that can be set in **[Movie options]** change.



Option	Description
<b>30 fps (30p/60p)</b>	Suited for playback on a TV using the NTSC standard.
<b>25 fps (25p/50p)</b>	Suited for playback on a TV using the PAL standard.

## External mic sensitivity

Shooting mode ➔ MENU button ➔  (movie menu) ➔  button ➔  
External mic sensitivity ➔  button

Set the sensitivity of the microphone that is connected to the camera's external microphone connector.

This option can be set only when an external microphone is connected.

Option	Description
 <b>A Auto sensitivity (default setting)</b>	The sensitivity of the external microphone is set automatically.
 <b>M Manual sensitivity</b>	The sensitivity of the external microphone is set manually.

## ■ Using the manual sensitivity screen

- The input level from the external microphone is displayed in the indicator (1).

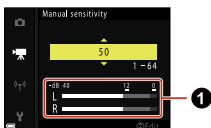

- Use the multi selector to adjust the value and press the **OK** button to apply the setting.

# The playback menu

## Mark for upload

Playback mode ➔ MENU button ➔ Mark for upload ➔  button



Select still images separately on the camera's playback screen, and then upload them to a smart device with the SnapBridge app installed.

Use this function when the network menu ➔ **[Send while shooting]** ➔ **[Still images]** is set to **[No]**, or when uploading images that are not selected using **[Upload (photos)]**.

To send images, enable the auto download function of the SnapBridge app. For use of the SnapBridge app, see the online help of the SnapBridge app (<https://nikonimglib.com/snbr/onlinehelp/en/index.html>).

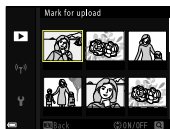
- 1 Use the multi selector  or rotate it to select the image you want to upload to a smart device.**



- Move the zoom control toward **T** () to switch to full-frame playback, or **W** () to switch to thumbnail playback.

## 2 Use ▲▼ to select ON or OFF.

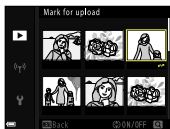

- When ON is selected,  is displayed under the selected image. Repeat steps 1 and 2 to select additional images.

## 3 Press the button to apply the image selection.

- The selected still images are uploaded to the smart device.

### Notes about [Mark for upload]

- Still images are uploaded at an image size of up to 2 megapixels.
- RAW images and movies cannot be selected for upload.
- Note that when you select the setup menu → [Reset all] or the network menu → [Restore default settings], the Mark for upload settings that you made are canceled and the camera settings are also reset to default.
- To cancel the Mark for upload settings, go to step 2 and hide .

### Tip: [Send while shooting]

When you use the network menu → [Send while shooting] (271), still images can be sent automatically to a smart device every time they are captured with the camera.

## Quick retouch

Playback mode → select an image → MENU button → Quick retouch →  button

Easily create images with high contrast and vivid colors.

- See “Before editing images” (📖173) for information about restrictions on editing.

## 1 Use the multi selector ▲▼ to select the desired effect level and press the Ⓞ button.

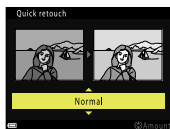

- The edited version is displayed on the right.
- To exit without saving the selection, press ◀.

## D-Lighting

Playback mode ➡ select an image ➡ MENU button ➡ D-Lighting ➡ Ⓞ button

Correct areas that are dark due to backlighting or insufficient light from the flash.

- See “Before editing images” (📖173) for information about restrictions on editing.

- 1 Use the multi selector ▲▼ to select the desired effect level and press the **OK** button.

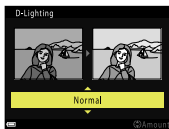

- The edited version is displayed on the right.
- To exit without saving the selection, press ◀.

## Skin softening

Playback mode ➡ select an image ➡ MENU button ➡ Skin softening ➡ **OK** button

Softens skin tones.

- See “Before editing images” (173) for information about restrictions on editing.

- 1 Use the multi selector ▲▼ to select the desired effect level and press the **OK** button.



- To exit without saving the copy, press ◀.

## 2 Preview the result and press the **OK** button.



- The edited face is zoomed in.
- When more than one face has been edited, press **◀▶** to switch the face that is displayed.
- To change the effect level, press the **MENU** button and return to step 1.

### ✓ **Notes about [Skin softening]**

- The skin tones can be enhanced for up to 12 faces, starting with the one closest to the center of the frame and moving outward.
- Depending on the direction in which faces are looking, or the brightness of faces, the camera may be unable to accurately detect faces, or the skin softening function may not perform as expected.
- If no faces are detected, a warning is displayed and the screen returns to the playback menu.

## Filter effects

Playback mode ➡ select an image ➡ **MENU** button ➡ Filter effects ➡ **OK** button

Use digital filters to apply various effects.

- See “Before editing images” (173) for information about restrictions on editing.

Option	Description
<b>Soft portrait</b>	Blurs the background of human subjects. When no human subjects are detected, keeps the area in the center of the frame in focus and blurs the surrounding area.
<b>Selective color</b>	Keeps only a selected color and makes other colors black-and-white.
<b>Cross screen</b>	Produces star-like rays of light that radiate outward from bright objects such as sunlight reflections and city lights. Suitable for night scenes.
<b>Fisheye</b>	Creates images that look like they were shot with a fisheye lens. Suitable for images shot in macro mode.
<b>Miniature effect</b>	Creates images that look like close-up photos of a diorama. Suitable for images shot while looking down from a high location, with the main subject near the center of the frame.
<b>Painting</b>	Creates images with the ambience of paintings.
<b>Vignette</b>	Lowers the peripheral light intensity from the center to the edges of an image.
<b>Photo illustration</b>	Emphasizes outlines and reduces the number of colors to create images with the ambience of illustrations.
<b>Portrait (color + B&amp;W)</b>	Makes colors of the background of human subjects black-and-white. When no human subjects are detected, keeps colors of the area in the center of the frame and makes the surrounding area black-and-white.

- 1 Use the multi selector ▲▼ to select the desired filter effect and press the **OK** button.

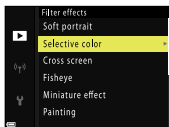

- If you selected an effect other than [**Selective color**], proceed to step 3.

- 2 Use ▲▼ to select the color to keep and press the **OK** button.



- 3 Preview the result and press the **OK** button.



- An edited copy is created.
- To exit without saving the copy, press ◀.

## Slide show

Playback mode ➔ MENU button ➔ Slide show ➔ OK button

Allows you to view images in an automated slide show. When movie files are played back in the slide show, only the first frame of each movie is displayed.

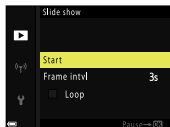

- 1 Use the multi selector ▲▼ to select **[Start]** and press the **OK** button.



- The slide show begins.
- To change the interval between images, select **[Frame intvl]**, press the **OK** button, and specify the desired interval time before selecting **[Start]**.
- To repeat the slide show automatically, select **[Loop]** and press the **OK** button before selecting **[Start]**.
- The maximum playback time is up to about 30 minutes even if **[Loop]** is enabled.

## 2 End or restart the slide show.





The following screen is displayed after the slide show ends or is paused.

To exit the show, select  and then press the  button.

To resume the slide show, select  and then press the  button.



## Operations during slide show playback

Function	Operation
Display the previous/next image	Press the multi selector     . Press and hold them down to change images quickly.
Pause or end the slide show	Press the  button.

## Protect

Playback mode  MENU button  Protect  

The camera protects selected images from accidental deletion.

- 
- 1 Use the multi selector ◀▶ or rotate it to select the desired image.**

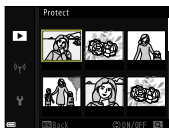

- Move the zoom control toward **T** (🔍) to switch to full-frame playback, or **W** (🖼️) to switch to thumbnail playback.

- 
- 2 Use ▲▼ to select ON or OFF.**

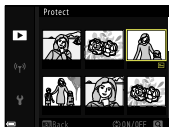

- When ON is selected, **ON** is displayed under the selected image. Repeat steps 1 and 2 to set **[Protect]** on additional images.

- 
- 3 Press the **OK** button to apply the setting.**

---

**✓ Notes about [Protect]**

Formatting the memory card permanently deletes all data including protected files.

---

## Rotate image

Playback mode ➡ MENU button ➡ Rotate image ➡ OK button

Specify the orientation in which saved images are displayed during playback. Still images can be rotated 90 degrees clockwise or 90 degrees counterclockwise.

Images that were saved in the “tall” orientation can be rotated up to 180 degrees in either direction.

- 1 Use the multi selector ◀▶ or rotate it to select the image you want to rotate, and press the OK button.

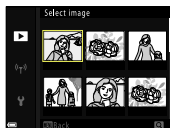

- Move the zoom control toward **T** (🔍) to switch to full-frame playback, or **W** (🖼️) to switch to thumbnail playback.

- 
- 2** Use ► or rotate the multi selector to rotate 90 degrees clockwise (❶), and use ◀ or rotate the multi selector to rotate 90 degrees counterclockwise (❷).

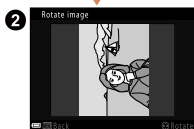
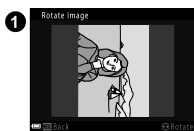

- 
- 3** Press the **OK** button to apply the orientation.

- The orientation information is saved with the image.

## Small picture

Playback mode ➔ select an image ➔ MENU button ➔ Small picture ➔ 

Create a small copy of images.

- See “Before editing images” (173) for information about restrictions on editing.

**1 Use the multi selector ▲▼ to select the desired copy size and press the  button.**

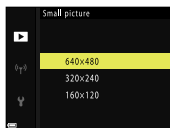

- When the aspect ratio of the image is 16:9, the image size is fixed at 640 × 360. Press the  button to proceed to step 2.

**2 Select [Yes] and press the  button.**

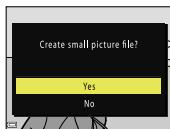

- An edited copy is created (compression ratio of approximately 1:8).

### Notes about [Small picture]



When the aspect ratio of the image is 3:2 or 1:1, the image cannot be edited.

## Sequence display options

Playback mode ➡ MENU button ➡ Sequence display options ➡ OK button

Select the method used to display images in the sequence.

- Settings are applied to all sequences, and the settings are saved in the camera's memory even after the camera is turned off.

Option	Description
<b>Individual pictures</b>	Displays each image in a sequence individually.  is displayed on the playback screen.
<b>Key picture only (default setting)</b>	Displays only the key picture for images in a sequence. Press the OK button on the playback screen to display images in a sequence (  168).

## Choose key picture

Playback mode ➡  
display a sequence for which you want to change the key picture ➡  
MENU button ➡ Choose key picture ➡ OK button

Specify a different image in the sequence as the key picture.

- 1 Use the multi selector ◀▶ or rotate it to select the image you want to set as the key picture, and press the OK button.**

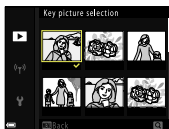

- Move the zoom control toward **T** (Ⓡ) to switch to full-frame playback, or **W** (Ⓢ) to switch to thumbnail playback.

## The network menu

Configure settings when establishing a wireless connection between the camera and a smart device, or the camera and ML-L7 Remote Control (available separately).

MENU button ➡  (network menu) ➡  button

- For connecting the camera to smart devices, see “Connecting to smart devices” (□301).
- For the functions that can be used with the remote control and connecting this camera and the remote control, see “ML-L7 Remote Control” (□325).

### Network menu list

Some options cannot be set while a wireless connection is established. To set them, disconnect the wireless connection.



Option	Description
<b>Airplane mode</b>	Select [ <b>On</b> ] to turn off all wireless connections.
<b>Choose connection</b>	Select whether to connect the camera to [ <b>Smart device</b> ] (default setting) or [ <b>Remote control</b> ].
<b>Connect to smart device</b>	Pair when connecting to a smart device through Bluetooth for the first time (□303).
<b>Connection to remote</b>	Pair when connecting to the ML-L7 Remote Control (available separately) for the first time (□329).

Option	Description
<b>Send while shooting</b>	<p>When set to <b>[Yes]</b>, still images can be sent automatically to a smart device connected through Bluetooth every time they are captured.</p> <ul style="list-style-type: none"> <li>• To send images, enable the auto download function of the SnapBridge app. For use of the SnapBridge app, see the online help of the SnapBridge app (<a href="https://nikonimglib.com/snbr/onlinehelp/en/index.html">https://nikonimglib.com/snbr/onlinehelp/en/index.html</a>).</li> <li>• Still images are uploaded at an image size of up to 2 megapixels. RAW images cannot be uploaded.</li> <li>• If you use the playback menu → <b>[Mark for upload]</b> (□256), you can select still images on the camera's playback screen to automatically upload them to a smart device.</li> </ul>
	<p><b>Upload (photos)</b></p> <p>Set the conditions for automatically sending still images.</p>
<b>Wi-Fi</b>	<p><b>[SSID]:</b> Set a 1- to 32-character alphanumeric SSID (□273).</p>
	<p><b>[Auth./encryp.]:</b> Choose <b>[Open]</b>, <b>[WPA2-PSK-AES]</b>, <b>[WPA3-SAE]</b>, or <b>[WPA2-PSK/WPA3-SAE]</b>. Communications are not encrypted when <b>[Open]</b> is selected.</p>
	<p><b>[Password]:</b> Set an 8- to 36-character alphanumeric password (□273).</p> <ul style="list-style-type: none"> <li>• To protect your privacy, we recommend that you change the password regularly.</li> </ul>

Option	Description
<b>Wi-Fi</b>	<p><b>[Channel]</b>: Select the channel used for the Wi-Fi connection. If the communication quality is poor or the image upload speed is extremely slow when using a Wi-Fi connection, try changing the channel.</p>
	<p><b>[Subnet mask]</b>: Use the default setting (<b>[255.255.255.0]</b>) under normal conditions.</p>
	<p><b>[DHCP server IP address]</b>: Use the default setting (<b>[192.168.0.10]</b>) under normal conditions.</p>
<p><b>Current settings</b></p>	<p>Confirm the current <b>[Network settings]</b> in a list.</p>
<b>Bluetooth</b>	<p><b>Connection</b></p> <p>Select [Enable] or <b>[Disable]</b> for <b>Bluetooth</b> communication.</p>
	<p><b>Paired devices</b></p> <p>Display smart devices that have been paired. You can change the smart device to connect with, or delete paired smart devices.</p> <ul style="list-style-type: none"> <li>• This camera can be paired with up to five smart devices (only one device can be connected at a time).</li> </ul>
	<p><b>Send while off</b></p> <p>Select <b>[On]</b> or <b>[Off]</b> to set whether the camera communicates with the smart device when the camera is off or in standby mode.</p>
<p><b>Restore default settings</b></p>	<p>Restore all network menu settings to their default values.</p>









---

## Tip: Bluetooth communication indicator and Wi-Fi communication indicator on the shooting screen

- About the Bluetooth communication indicator
    - When the camera is connected to a smart device via Bluetooth,  is displayed.
    - When the camera is waiting for the connection to a smart device to be reestablished,  flashes. It also flashes when Bluetooth communication is disconnected while uploading images.
  - About the Wi-Fi communication indicator
    - When the camera is preparing to connect to a smart device via Wi-Fi,  is displayed. It is also displayed when the camera is connected to a smart device via Wi-Fi.
- 

## Text entry



- Use the multi selector  to select alphanumeric characters on the keyboard (1). Press the  button to enter the selected character in the text field (2) and move the cursor to the next space.
- To move the cursor in the text field, select  or  on the keyboard, and press the .
- To delete one character, press the .
- To apply the setting, select  on the keyboard and press the  button.

# The setup menu

## Time zone and date

MENU button ➔ ⚙ (setup) ➔ Ⓞ button ➔ Time zone and date ➔ Ⓞ button

Set the camera clock.

Option	Description
<b>Date and time</b>	<p>Set the date and time.</p>  <ul style="list-style-type: none"><li>• Select a field: Press the multi selector ◀▶.</li><li>• Edit the date and time: Press ▲▼. Date and time can also be changed by rotating the multi selector or command dial.</li><li>• Apply the setting: Select the minute field setting and press the Ⓞ button or ▶.</li></ul>
<b>Date format</b>	<p>Select [Year/Month/Day], [Month/Day/Year], or [Day/Month/Year].</p>
<b>Time zone</b>	<p>Set time zone and daylight saving time.</p> <ul style="list-style-type: none"><li>• When [Travel destination] (📍) is set after having set the home time zone (🏠), the time difference between the travel destination and the home time zone is automatically calculated, and the date and time are saved for the selected region.</li></ul>

## ■ Setting the time zone

---

- 1 Use the multi selector ▲▼ to select [Time zone] and press the **OK** button.

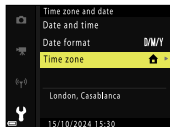

- 2 Select **Home time zone** or **Travel destination** and press the **OK** button.

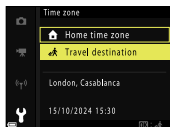

- The date and time displayed on the screen changes depending on whether the home time zone or travel destination is selected.

- 3 Press **▶**.

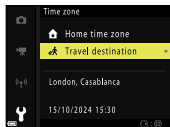

## 4 Use ◀▶ to select the time zone.

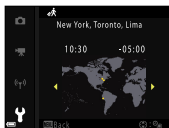

- Press ▲ to enable daylight saving time function, and ☀ is displayed. Press ▼ to disable the daylight saving time function.
- Press the Ⓞ button to apply the time zone.
- If the correct time is not displayed for the home or travel destination time zone setting, set the appropriate time in [Date and time].

### Slot empty release lock

MENU button ➡ ⚙ (setup) ➡ Ⓞ button ➡ Slot empty release lock ➡ Ⓞ button

Set whether or not the shutter can be released when no memory card is inserted in the camera.











Option	Description
<b>Release locked (default setting)</b>	Unless a memory card is inserted in the camera, the shutter cannot be released.

Option	Description
<b>Enable release</b>	Even when no memory card is inserted in the camera, the shutter can be released. However, [ <b>Demo mode</b> ] is displayed on the image captured when no memory card is inserted and the image cannot be saved on a memory card, although the image is displayed on the screen. Also, the image cannot be transferred to a smart device.

## Monitor settings

MENU button ➔  (setup) ➔  button ➔ Monitor settings ➔  button

Configure settings such as image review and monitor brightness.

Option	Description
<b>Image review</b>	Set whether or not to display the captured image immediately after shooting. <ul style="list-style-type: none"> <li>• Default setting: [<b>On</b>]</li> </ul>
<b>Monitor options</b>	Adjust the monitor brightness and hue. <ul style="list-style-type: none"> <li>• Use the multi selector   to adjust brightness,   to adjust hue and then press the  button.</li> <li>• Default setting: Brightness [<b>3</b>], Hue [<b>0</b>]</li> <li>• Cannot be set when the viewfinder is used.</li> </ul>
<b>EVF options</b>	Adjust the viewfinder brightness and hue. <ul style="list-style-type: none"> <li>• Use the multi selector   to adjust brightness,   to adjust hue and then press the  button.</li> <li>• Default setting: Brightness [<b>3</b>], Hue [<b>0</b>]</li> <li>• Cannot be set when the monitor is used.</li> </ul>

Option	Description
<b>View/hide framing grid*</b>	<p>Set whether or not to display a boxed guide for framing on the shooting screen.</p> <ul style="list-style-type: none"> <li>• Default setting: <b>[Off]</b></li> <li>• The framing grid is not displayed when the enlarged center of the image is displayed on the screen while using manual focus.</li> </ul>
<b>View/hide histograms*</b>	<p>Set whether or not to display a graph that shows the brightness distribution in the image (☐145) on the shooting screen.</p> <ul style="list-style-type: none"> <li>• Default setting: <b>[Off]</b></li> <li>• In Auto mode and Creative mode, the histogram is displayed only when the focus-mode selector is set to <b>MF</b>.</li> <li>• When in <b>P, S, A, M,</b> or <b>U</b> mode and the focus-mode selector is set to <b>AF</b>, the histogram is displayed if the shooting menu → <b>[AF area mode]</b> is set to a setting other than <b>[Target finding AF]</b> (default setting). When <b>[Subject tracking]</b> is selected, the histogram is not displayed during subject tracking.</li> <li>• The histogram is not displayed in Movie manual mode.</li> <li>• The histogram is not displayed in <b>[Easy panorama]</b> scene mode.</li> <li>• When the focus-mode selector is set to <b>MF</b>, the histogram is not displayed while the focus is being set. It is displayed when you press the multi selector ▼ and lock the focus.</li> </ul>
<b>Virtual horizon*</b>	<p>Set whether or not to display a virtual horizon on the shooting screen (☐280).</p> <ul style="list-style-type: none"> <li>• Default setting: <b>[Off]</b></li> </ul>

\* To display or hide these indicators, press the **DISP** (display) button when **[On]** is selected.

They are not displayed while recording a movie.

## Virtual horizon

You can check the degree of camera tilt in two directions.

- Rolling direction

When the reference line is displayed in yellow, the camera is tilted in the left or right direction. The reference line changes to green when the camera is level. Each scale mark represents 5 degrees.



- Pitching direction

When the ● in the center is displayed in yellow, the camera is tilted in the forward or backward direction. The changes to green when the camera is level. Each scale mark represents 10 degrees.

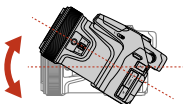

## Tip: Precision of the virtual horizon

Note that an error becomes large if the camera is tilted forward or backward greatly. If the camera is tilted to the unmeasurable extent, the graduations of the virtual horizon turns off.

## EVF auto toggle

MENU button → **Y** (setup) → **OK** button → EVF auto toggle → **OK** button

Toggle the EVF (electronic viewfinder) automatically.

Option	Description
<b>On</b> <b>(default setting)</b>	When you bring your face close to the viewfinder, the eye sensor responds to it and the display is automatically switched from the monitor to viewfinder.
<b>Off</b>	Even when you bring your face close to the viewfinder, the display is not switched to the viewfinder.

## Date stamp

MENU button → **Y** (setup) → **OK** button → Date stamp → **OK** button

The shooting date and time can be stamped on images when shooting.



Option	Description
<b>DATE</b> Date	Date is stamped on images.
<b>DATE</b> <b>TIME</b> Date and time	Date and time are stamped on images.

Option	Description
<b>Off</b> <b>(default setting)</b>	Date and time are not stamped on images.

### ✓ Notes about [Date stamp]

- Stamped date and time form a permanent part of image data and cannot be deleted. The date and time cannot be stamped on images after they have been captured.
- The date and time cannot be stamped in the following situations:
  - When in [**Bird-watching**] mode (when set to [**Continuous**])
  - When the scene mode is set to [**Sports**], [**Night portrait**] (when set to [**Hand-held**]), [**Night landscape**] (when set to [**Hand-held**]), [**Backlighting**] (when [**HDR**] is set to [**On**]), [**Easy panorama**], [**Pet portrait**] (when set to [**Continuous**]), [**Multiple exp. Lighten**], [**Time-lapse movie**], or [**Superlapse movie**]
  - When [**Image quality**] is set to [**RAW**], [**RAW + Fine**], or [**RAW + Normal**]
  - When [**Pre-shooting cache**], [**Continuous H: 120 fps**], or [**Continuous H: 60 fps**] is selected for [**Continuous**]
  - When recording movies
  - When saving still images during movie recording
  - When extracting still images from a movie during movie playback
- The stamped date and time may be difficult to read when using a small image size.



## Self-timer: after release

MENU button ➡ **Y** (setup) ➡ **OK** button ➡ Self-timer: after release ➡ **OK** button

Select whether or not to cancel the self-timer setting after shooting with self-timer.





Option	Description
<b>Exit self-timer mode (default setting)</b>	<p>The self-timer is canceled after shooting.</p> <ul style="list-style-type: none"> <li>After shooting with self-timer in Moon mode, the self-timer setting is [🕒3s] (3 seconds). To end self-timer, manually set the self-timer setting to OFF.</li> <li>[Pet portrait auto release] and [Smile timer] are not canceled.</li> </ul>
<b>Stay in self-timer mode</b>	<p>The self-timer photography continues after shooting.</p> <ul style="list-style-type: none"> <li>When the camera is turned off, self-timer is canceled.</li> </ul>

## Vibration reduction

MENU button ➡  (setup) ➡  button ➡ Vibration reduction ➡  button

Select the vibration reduction setting used when shooting.

Select [Off] when using a tripod to stabilize the camera during shooting.

Option	Description
 <b>Normal (default setting)</b>	Suited to capturing images of subjects that are not moving.
 <b>Active</b>	Suited to capturing images if a relatively large camera shake is likely to occur, such as when shooting from a car or under poor foothold conditions.
 <b>Normal (framing first)</b>	Compared to the [Normal] setting, you can reduce the amount of difference between your intended composition and the captured image.
 <b>Active (framing first)</b>	Compared to the [Active] setting, you can reduce the amount of difference between your intended composition and the captured image.
<b>Off</b>	Compensation is not performed.

## ✔ Notes about [Vibration reduction]

- After turning on the camera or after switching from playback mode to shooting mode, wait until the shooting screen is ready before taking pictures.
- **[Normal]** or **[Active]** is recommended if you are not concerned about the slight variations in image composition that may occur. The amount of camera shake compensation is higher than that of **[Normal (framing first)]** or **[Active (framing first)]**.
- **[Normal (framing first)]** is recommended when you intend to significantly change the direction of the camera while shooting, such as when panning. The camera automatically detects the panning direction and only compensates for vibration caused by camera shake.
- Images on the screen may be displayed blurry immediately after shooting.
- Vibration reduction may be unable to completely eliminate the effects of camera shake in some situations.

## AF assist

MENU button ➡ Y (setup) ➡ OK button ➡ AF assist ➡ OK button

Allows you to enable or disable the AF-assist illuminator.

Option	Description
<b>Auto (default setting)</b>	The AF-assist illuminator automatically lights up when you press the shutter-release button under dim lighting. The illuminator has a range of about 5.0 m (16 ft) at the maximum wide-angle position and about 7.0 m (22 ft) at the maximum telephoto position. <ul style="list-style-type: none"><li>• Note that for some scene modes or focus areas, the AF-assist illuminator may not light.</li></ul>
<b>Off</b>	The AF-assist illuminator does not light.

## Digital zoom

MENU button ➔  (setup) ➔  button ➔ Digital zoom ➔  button



Set whether to use the digital zoom.

Option	Description
<b>On</b> (default setting)	Digital zoom is enabled.
<b>Off</b>	Digital zoom is disabled.

### ✔ Notes about [Digital zoom]

- Digital zoom cannot be used in the following scene modes:
  - [Portrait], [Night portrait], [Backlighting] (when [HDR] is set to [On]), [Easy panorama], [Pet portrait], [Time-lapse movie], [Superlapse movie]
- Digital zoom cannot be used in other shooting modes when using certain settings (□156).

## Assign side zoom control

MENU button ➔  (setup) ➔  button ➔ Assign side zoom control ➔  button

Choose the function to be performed during shooting when the side zoom control is moved.

Option	Description
<b>Zoom</b> (default setting)	When shooting, use the side zoom control to adjust the zoom.

Option	Description
<b>Manual focus</b>	<p>When the focus-mode selector is set to <b>MF</b> (manual focus), use the side zoom control to focus.</p> <ul style="list-style-type: none"> <li>• Move the side zoom control toward <b>T</b> to focus on distant subjects.</li> <li>• Move the side zoom control toward <b>W</b> to focus on near subjects.</li> <li>• When the focus-mode selector is set to <b>AF</b> (autofocus), the side zoom control operation is disabled.</li> </ul>

## Snap-back zoom

MENU button ➔ **Y** (setup) ➔ **OK** button ➔ Snap-back zoom ➔ **OK** button

Select the size of the area that is temporarily visible when the  (snap-back zoom) button is pressed.

- You can select [**Snap back: long**] (default setting), [**Snap back: medium**], or [**Snap back: short**].

## Control ring options

MENU button ➔ **Y** (setup) ➔ **OK** button ➔ Control ring options ➔ **OK** button

Select the option for the control ring when the focus-mode selector is set to **AF** (autofocus).

Option	Description
<b>Exposure compensation (default setting)</b>	Exposure compensation can be set with the control ring.

Option	Description
<b>ISO sensitivity</b>	<p>ISO sensitivity can be set with the control ring when the shooting mode is <b>P</b>, <b>S</b>, <b>A</b>, <b>M</b>, or Movie manual (except when an HS movie option is selected in <b>[Movie options]</b>).</p> <ul style="list-style-type: none"> <li>Rotate the control ring in shooting mode, rotate the multi selector or the control ring to select a setting in the displayed screen, and press the <b>OK</b> button or <b>▶</b> to apply it.</li> </ul>
<b>White balance</b>	<p>White balance can be set with the control ring when the shooting mode is <b>P</b>, <b>S</b>, <b>A</b>, <b>M</b>, or Movie manual.</p> <ul style="list-style-type: none"> <li>Rotate the control ring in shooting mode, rotate the multi selector or the control ring to select a setting in the displayed screen, and press the <b>OK</b> button or <b>▶</b> to apply it.</li> </ul>
<b>None</b>	The control ring operation is disabled when the focus-mode selector is set to <b>AF</b> (autofocus).

## AE/AF lock button

MENU button ➡ **Y** (setup) ➡ **OK** button ➡ AE/AF lock button ➡ **OK** button

Set the function to be performed when the **AE-L/AF-L** (AE-L/AF-L) button is pressed while shooting.

Option	Description
<b>AE/AF lock (default setting)</b>	Hold down the <b>AE-L/AF-L</b> button to lock both the focus and exposure. When recording movies, the focus and exposure remain locked after you press the <b>AE-L/AF-L</b> button. To unlock, press the button again.

Option	Description
<b>AE lock only</b>	Hold down the $\text{AE-L}$ button to lock the exposure. When recording movies, the exposure remains locked after you press the $\text{AE-L}$ button. To unlock, press the button again.
<b>AE lock (Hold)</b>	Press the $\text{AE-L}$ button to lock the exposure. To unlock, press the button again.
<b>AF lock only</b>	Hold down the $\text{AE-L}$ button to lock the focus. When recording movies, the focus remains locked after you press the $\text{AE-L}$ button. To unlock, press the button again.



## Sound settings

MENU button  $\Rightarrow$   $\text{Y}$  (setup)  $\Rightarrow$   $\text{OK}$  button  $\Rightarrow$  Sound settings  $\Rightarrow$   $\text{OK}$  button

Set operation sounds.

Option	Description
<b>Button sound</b>	<p>When <b>[On]</b> (default setting) is selected, the camera produces one beep when operations are performed, two beeps when focus is acquired on the subject, and three beeps when an error occurs.</p> <ul style="list-style-type: none"> <li>• Sounds are disabled when using Bird-watching mode or <b>[Pet portrait]</b> scene mode.</li> </ul>
<b>Shutter sound</b>	<p>When <b>[On]</b> (default setting) is selected, the shutter sound is produced when the shutter is released.</p> <ul style="list-style-type: none"> <li>• The shutter sound is not produced when using continuous shooting mode (except <b>[Continuous H]</b> and <b>[Continuous L]</b>), when using exposure bracketing, when recording movies, when using Bird-watching mode, or when using <b>[Easy panorama]</b> or <b>[Pet portrait]</b> scene mode.</li> </ul>

## Auto off

MENU button ➡  (setup) ➡  button ➡ Auto off ➡  button

Set the amount of time that elapses before the camera enters standby mode.

- You can select [**30 s**], [**1 min**] (default setting), [**5 min**], or [**30 min**].



---

### Tip: Setting the auto off function

The time that passes before the camera enters standby mode is fixed in the following situations:

- When a menu is displayed: 3 minutes (when auto off is set to [**30 s**] or [**1 min**])
  - When the AC adapter is connected: 30 minutes
- 

## Format card



MENU button ➡  (setup) ➡  button ➡ Format card ➡  button

Use this option to format a memory card.

**Formatting the memory cards permanently deletes all data. Data that has been deleted cannot be recovered.** Make sure to save important images to a computer before formatting.



- To start formatting, select [**Format**] on the screen that is displayed and press the  button.
- Do not turn the camera off or open the battery-chamber/memory card slot cover during formatting.
- You may not be able to select this setting while a wireless connection is established.

## Language

MENU button ➡  (setup) ➡  button ➡ Language ➡  button

Select a language for display of camera menus and messages.

## HDMI

MENU button ➔  (setup) ➔  button ➔ HDMI ➔  button

Set the HDMI output of the camera.

You can output the live view image to HDMI-compatible devices without the information display, or set the output resolution.

- The camera screen does not turn on while the camera is connected to an HDMI-compatible device.

Option	Description
<b>Clean HDMI output</b>	<p data-bbox="353 107 917 278">Output the live view image without the information display to an HDMI-compatible device. Use this option when you want to record images from the camera to a commercially available external recorder.</p> <ul data-bbox="353 292 917 1118" style="list-style-type: none"> <li data-bbox="353 292 917 355">• Rotate the mode dial to Movie manual. In addition, set the focus-mode selector to <b>MF</b>.</li> <li data-bbox="353 365 917 463">• Turn on the camera by using the power switch after connecting the camera to an HDMI-compatible device.</li> <li data-bbox="353 473 917 535">• The sound that is picked up by the microphone is output to the HDMI-compatible device.</li> <li data-bbox="353 546 917 681">• When an information display appears on an external recorder monitor, press the <b>DISP</b> button of the camera several times to turn off the information display.</li> <li data-bbox="353 691 917 719">• 4K UHD image quality cannot be output.</li> <li data-bbox="353 729 917 899">• Peaking display, as well as the movie menu → [<b>Movie options</b>] and [<b>Frame rate</b>], are not available while the camera is connected to an HDMI-compatible device. Still images cannot be captured with the camera.</li> <li data-bbox="353 910 917 1118">• While the camera is connected to an HDMI-compatible device, you can press the ● (▶ movie-record) button on the camera to record a movie and save it on the memory card in the camera. The power-on lamp flashes while the camera is recording movies.</li> </ul>
<b>Off (default setting)</b>	<p data-bbox="353 1145 917 1243">Use this option to view captured images. You can also capture still images or record movies with the camera while viewing the subject on a TV monitor.</p>

Option	Description
<b>HDMI output</b>	<p>Select the image resolution when [<b>Clean HDMI output</b>] is set to [<b>On</b>].</p> <ul style="list-style-type: none"> <li>• The image resolution setting is fixed at [<b>Auto</b>] when [<b>Clean HDMI output</b>] is set to [<b>Off</b>].</li> </ul>



### ✔ Notes about connection via HDMI

Wireless communication is not available when the camera and an HDMI-compatible device are connected. You also cannot use the ML-L7 Remote Control (available separately).

### ✔ Notes About HDMI Output Resolution

When [**Clean HDMI output**] is set to [**Off**], or when it is set to [**On**] while [**Auto**] (default setting) is selected for [**HDMI output**], the camera detects the resolution of the output device and automatically sets the HDMI output resolution.

## Charge by computer

MENU button ➡  (setup) ➡  button ➡ Charge by computer ➡  button

Allows you to set whether or not the battery in the camera is charged when the camera is connected to a computer.

Option	Description
<b>AUTO Auto (default setting)</b>	<p>When the camera is connected to a computer that is running, the battery inserted into the camera is automatically charged using power supplied by the computer.</p> <ul style="list-style-type: none"> <li>• The power-on lamp (charge lamp) flashes while the battery is charging. When charging is complete, the power-on lamp (charge lamp) changes from flashing to on.</li> </ul>

Option	Description
Off	The battery inserted into the camera is not charged when the camera is connected to a computer.

### ✔ Notes about charging with a computer

- When connected to a computer, the camera turns on and starts charging. If the camera is turned off, charging stops.
- Charging time increases when images are transferred while the battery is charging.
- The camera turns off automatically if there is no communication with the computer for 30 minutes after the battery has finished charging.
- The camera battery can also be charged when the camera is connected to a computer using the optional UC-E25 USB Cable (with two Type C connectors).
- When charging, do not use the connectors of a USB hub or keyboard. Connect the camera and computer directly.

### ✔ When the power-on lamp (charge lamp) quickly flashes

Charging cannot be performed, possibly due to one of the reasons described below.

- The ambient temperature is not suited to charging. Charge the battery indoors at ambient temperatures of 5 °C–35 °C (41 °F–95 °F).
- The USB cable is not connected correctly or the battery is faulty. Make sure that the USB cable is connected correctly or replace the battery if necessary.
- Power is not being supplied if the computer goes into sleep mode during charging. Wake up the computer from sleep mode.
- The battery cannot be charged because the computer cannot supply power to the camera due to the model of the computer or its specifications.

## Image comment

MENU button ➔ Y (setup) ➔ OK button ➔ Image comment ➔ OK button

Allows you to attach a comment that was previously registered to images that will be captured.

- You can imprint the attached comment to images that will be sent to a smart device using the SnapBridge app. You must configure the SnapBridge app in advance. See the SnapBridge app online help (<https://nikonimglib.com/snbr/onlinehelp/en/index.html>) for details.

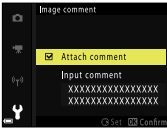
Option	Description
<b>Attach comment</b>	<p>A comment registered with <b>[Input comment]</b> is attached to images.</p>  <p>• Select <b>[Attach comment]</b>, press ►, and set the check box to on (✓). When the OK button is pressed, the comment will be attached to the images captured afterwards.</p>
<b>Input comment</b>	<p>You can register a comment of up to 36 alphanumeric characters.</p> <ul style="list-style-type: none"><li>• Select <b>[Input comment]</b>, press ►, and the input screen is displayed (□273).</li></ul>

### ✓ Notes about **[Image comment]**

Image comments cannot be attached to movies.

## Copyright information

MENU button ➔ Y (setup) ➔ OK button ➔ Copyright information ➔ OK button

Allows you to attach the copyright information that was previously registered to images that will be captured.

- You can imprint the attached copyright information to images that will be sent to a smart device using the SnapBridge app. You must configure the SnapBridge app in advance. For details, see the online help for the SnapBridge app (<https://nikonimglib.com/snbr/onlinehelp/en/index.html>).

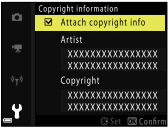
Option	Description
<b>Attach copyright info</b>	<p>Copyright information registered with <b>[Artist]</b> and <b>[Copyright]</b> is attached to images.</p>  <p>The screenshot shows a camera's menu screen titled 'Copyright information'. The first option, 'Attach copyright info', is highlighted in yellow and has a checkmark icon to its left. Below it are two options: 'Artist' and 'Copyright', each followed by a line of ten 'X' characters representing a text input field. At the bottom of the screen, there are 'Set' and 'Confirm' options.</p> <ul style="list-style-type: none"><li>• Select <b>[Attach copyright info]</b>, press ►, and set the check box to on (✓). When the OK button is pressed, the copyright information will be attached to the images captured afterwards.</li></ul>
<b>Artist</b>	<p>You can register an artist name of up to 36 alphanumeric characters.</p> <ul style="list-style-type: none"><li>• Select <b>[Artist]</b>, press ►, and the input screen is displayed (□273).</li></ul>

Option	Description
<b>Copyright</b>	You can register a copyright owner name of up to 54 alphanumeric characters. <ul style="list-style-type: none"> <li>· Select [<b>Copyright</b>], press ►, and the input screen is displayed (□□273).</li> </ul>

### ✓ Notes about [Copyright information]

- To prevent illegal use of artist names and copyright owner names when lending or transferring ownership of the camera, make sure to disable the [**Attach copyright info**] setting. Also, make sure that the artist name and copyright owner name are blank.
- Nikon is not responsible for any kind of trouble or damage resulting from the use of [**Copyright information**].
- Copyright information cannot be attached to movies.

### Tip: Copyright information display

When copyright information is entered for both [**Artist**] and [**Copyright**], only the Copyright entry is imprinted to the images in the SnapBridge app.

## Location data

MENU button ➡ Y (setup) ➡ OK button ➡ Location data ➡ OK button



Set whether or not to add shooting location information to the images that you take.

Option	Description
<b>Record location data</b>	Select [ <b>Yes</b> ] to add location information from a smart device to the images that you take. Enable the location information function of the SnapBridge app.
<b>Position</b>	Display the obtained location information.

## ✔ Notes about [Location data]

Note that the camera may be unable to download or display location data from smart devices depending on the version of the device operating system and/or SnapBridge app used.

## Toggle Av/Tv selection



MENU button ➔  (setup) ➔  button ➔ Toggle Av/Tv selection ➔  button

Change which controls to use for setting the exposure in the following shooting modes.

- **P, S, A, M, U, ** (Movie manual) mode
- **[Multiple exp. Lighten]** scene mode (when **[Nightscape + light trails]** or **[Fireworks]** is set)

Option	Description
<b>Do not toggle selection (default setting)</b>	Use the command dial to set the flexible program or shutter speed (Tv), and the multi selector to set the f-number (Av).
<b>Toggle selection</b>	Use the multi selector to set the flexible program or shutter speed (Tv), and the command dial to set the f-number (Av).

## Reset file numbering

MENU button ➔  (setup) ➔  button ➔ Reset file numbering ➔  button

Reset file numbering.

- When **[Yes]** is selected, a new folder is created and the file number for the next image captured starts with "0001."

## ✓ Notes about [Reset file numbering]

[Reset file numbering] cannot be applied when the folder number reaches 999 and there are images in the folder. Change the memory card, or use

[Format card] (□289) to format the memory card.



- [Reset file numbering] cannot be performed when the write-protect switch on the memory card is in the “lock” position. Slide the write-protect switch to the “write” position (□48, □361).

## Tip: Folders for storing files

Still images and movies shot or recorded with this camera are saved in folders of the memory card.

- Sequential numbers are added to folder names in ascending order, starting with “100” and ending with “999” (the folder names are not displayed on the camera).
- A new folder is created in the following situations:
  - When the number of files in a folder reaches 999
  - When a file in a folder is numbered “9999”
  - When [Reset file numbering] is performed
- A new folder is created each time a series of images are captured using interval timer shooting, and the images are saved in that folder with file numbers starting with “0001.”

## Peaking

MENU button ➡  (setup) ➡  button ➡ Peaking ➡  button

When operating manual focus, focusing is assisted by highlighting areas that are in focus in white on the image displayed on the screen.

Option	Description
On (default setting)	Peaking is enabled.
Off	Peaking is disabled.

## ✔ Notes about peaking

After turning on the camera or after switching from playback mode to shooting mode, peaking display is disabled.

Press the multi selector ▼ (□140, □143).

## Reset all

MENU button ➡ Y (setup) ➡ OK button ➡ Reset all ➡ OK button

Allows you to reset the camera's settings to their default values.

When **[Reset]** is selected, the camera's settings are restored to their default values.

- The network menu settings are also restored to their default values. To use the SnapBridge app, unpair in SnapBridge and then pair again (□303). To use the ML-L7 Remote Control, pair it again (□329).
- Some settings, such as **[Time zone and date]** or **[Language]**, are not reset. User settings that were saved in **U** of the mode dial are not reset. To reset these settings, use **[Reset user settings]** (□88).
- You may not be able to select this setting while a wireless connection is established.

### Tip: Resetting file numbering

To reset file numbering to "0001", delete all images saved on the memory card before selecting **[Reset all]**. **[Reset file numbering]** can also be used to reset to "0001" (□297).

## Conformity marking

MENU button ➡ Y (setup) ➡ OK button ➡ Conformity marking ➡ OK button

View some of the standards with which the camera complies.

## Firmware version

MENU button ➡ Y (setup) ➡ OK button ➡ Firmware version ➡ OK button

View the current camera firmware version.

- You may not be able to select this setting while a wireless connection is established.

# Connecting to smart devices

## The SnapBridge app

Use the SnapBridge app for wireless connections between the camera and your smartphone or tablet (“smart device”).



- SnapBridge apps can be downloaded from the Apple App Store® or on Google Play™.



- Visit the Nikon website for the latest SnapBridge news.
- Carefully read any license agreements or the like displayed when SnapBridge is launched and only proceed if you are willing to accept them.

## What SnapBridge can do for you

The tasks that can be performed using the SnapBridge app are outlined below. For details, see the SnapBridge app online help:  
<https://nikonimglib.com/snbr/onlinehelp/en/index.html>

### ■ Downloading pictures from the camera

Download existing pictures to your smart device. Pictures can be uploaded as they are taken.

- RAW images and movies cannot be uploaded.

## ■ Remote photography

Control the camera and take pictures from the smart device.

---

### ✔ Can't connect?

If you have trouble connecting, try:

- turning the camera and smart device off and then on again, or
  - checking wireless settings on the smart device.
-

## Wireless connections

Use the SnapBridge app for wireless connections between the camera and your smart device via Bluetooth (☎303). Depending on the SnapBridge app function, you may need to switch the connection method from Bluetooth to Wi-Fi (☎307) after connecting.

### Connecting via Bluetooth (pairing)

Before connecting via Bluetooth for the first time, you will need to pair the camera and smart device.

---

#### ✔ Before pairing

- Enable Bluetooth on the smart device. For details, see the documentation provided with the device.
  - Ensure that the batteries in the camera and smart device are fully charged to prevent the devices turning off unexpectedly.
  - Check that there is space available on the camera memory card.
- 

### ■ Pairing

Pair the camera and smart device as described below.

- Some operations are performed using the camera, others on the smart device.

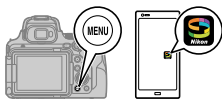

- Additional instructions are available via SnapBridge online help.

---

#### **1** Camera: Press the MENU button.

---

**2 Camera:** Press the multi selector ◀, use ▲▼ to select  (network menu), and press the  button.

---

**3 Camera:** Select [Connect to smart device], and press the  button.

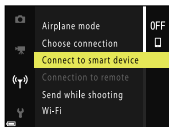

The camera name will be displayed in the screen.

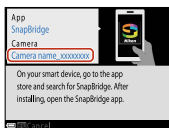

---

**4 Smart device:** Launch the SnapBridge app, open the  tab and tap [Connect to camera].

When launching the SnapBridge app for the first time after downloading, tap [Connect to camera] on the app's introduction screen.

---

**5 Smart device:** Follow the on-screen instructions.

- When prompted, tap the category for your camera and then tap the “pairing” option when prompted to choose the connection type.
- Tap the camera name when prompted.

---

**6 Camera/smart device: After confirming that the camera and smart device display the same authentication code, follow the on-screen instructions on both devices to complete pairing.**

- Tap the pairing button on the smart device and press the  button on the camera.
- The camera and smart device will each display a message when pairing is complete.



**The camera and smart device are now paired.**

**For information on using the SnapBridge app, see online help.**

---

## ✔ If the camera and smart device cannot be paired

Confirm that the settings in the camera **[Network menu]** are configured as follows.

- **[Airplane mode]: [Off]**
- **[Choose connection]: [Smart device]**
- **[Bluetooth] → [Connection]: [Enable]**

## ✔ Pairing error

If you wait too long between pressing the button on the camera and tapping the button on the smart device in Step 6, the device will display an error message and pairing will fail.

- If you are using an Android device, tap **[OK]** and return to Step 1.
- If you are using an iOS device, dismiss the SnapBridge app and check that it is not running in the background, then request iOS to “forget” the camera before returning to Step 1. The request to “forget” the camera is made via the iOS “Settings” app.

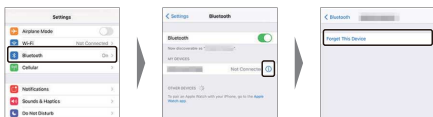

## ✔ Disabling Bluetooth

To disable Bluetooth, select the network menu → **[Bluetooth]** → **[Connection]** → **[Disable]** in the camera.

---

## ■ Connecting to a previously-paired smart device

Once the smart device has been paired with the camera, you will be able to connect simply by enabling Bluetooth on both the smart device and camera and launching the SnapBridge app.

## **Switching to Wi-Fi connection**

After connecting via Bluetooth, you may need to switch to Wi-Fi connection to use the download function or remote photography function of the SnapBridge app.

---

### **✔ Before connecting via Wi-Fi**

- Enable Wi-Fi on the smart device. For details, see the documentation provided with the device.
  - Ensure that the batteries in the camera and smart device are fully charged to prevent the devices turning off unexpectedly.
  - Check that there is space available on the camera memory card.
- 

## **■ Switching connection methods**

Follow the steps below to establish a Wi-Fi connection between the camera and smart device using the SnapBridge app.

- Additional instructions are available via SnapBridge online help.
- 

### **1 Smart device: While connected via Bluetooth, select the SnapBridge app image download function or remote photography function.**

The Wi-Fi connection confirmation dialog will be displayed.

---

### **2 Smart device: Tap [OK] in the dialog.**

---

### 3 Smart device: Operate the smart device following the instructions on the app screen to switch to Wi-Fi.

- On iOS devices, the “Settings” app will launch. Tap [**< Settings**] to open [**Settings**], then scroll up and tap [**Wi-Fi**] (which you’ll find near the top of the settings list) to display Wi-Fi settings.

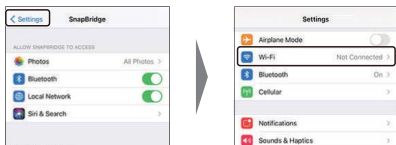

- On the Wi-Fi connection screen, select the camera SSID and enter the password. You can confirm or change the camera SSID or password in network menu → [**Wi-Fi**] → [**Network settings**].

---

### 4 Smart device: After adjusting device settings as described in Step 3, return to the SnapBridge app as necessary.

- After establishing a Wi-Fi connection to the camera, the smart device will display an image download function or remote photography function screen.

**The camera and smart device have switched to Wi-Fi connection. For information on using the SnapBridge app, see the online help for the SnapBridge app.**

# Connecting the camera to a TV or computer

## Viewing images on a TV

You can connect the camera to a TV with a commercially available HDMI cable to view images and movies captured with the camera on the TV.

### ✓ Notes about connecting the camera to a TV

- Make sure that the camera battery is sufficiently charged. If the EH-5d AC Adapter and the EP-5C Power Connector (both available separately) are used, this camera can be powered from an electrical outlet. Do not, under any circumstances, use an AC adapter other than the EH-5d. Failure to observe this precaution could result in overheating or damage to the camera.
- For information about the connection methods and subsequent operations, refer to the documentation included with the TV in addition to this document.

### **1** Turn off the camera.

---

**2 Use a commercially available HDMI cable to connect the camera's HDMI micro connector (Type D) and the TV's HDMI input port.**

- Check the shape and direction of the plugs and do not insert or remove the plugs at an angle.

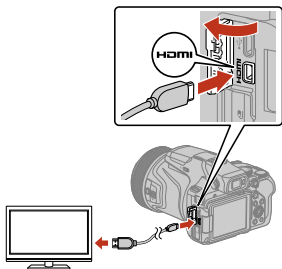

---

**3 Set the TV's input to external input.**

- See the documentation provided with your TV for details.

---

#### 4 Press and hold down the (playback) button to turn on the camera.

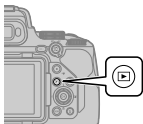

- Images are displayed on the TV.
- The camera screen does not turn on.
- When you turn on the camera using the power switch, the shooting screen is displayed on the TV. To show the captured images and movies on the TV, press the  button to enter playback mode.

---

#### **Notes About Connecting the HDMI Cable**

When using a USB cable, the camera cannot perform HDMI output to the TV.

---

#### **Tip: Playing back 4K movies**

To play back movies that are recorded with [2160/30p] (4K UHD) or [2160/25p] (4K UHD) in 4K UHD image quality, use a television and HDMI cable that are compatible with 4K. Also, select the setup menu → [HDMI] → [Clean HDMI output] → [Off].

- When playing back 4K movies on certain TVs, the first few seconds may not be displayed because it takes some time for the TV to adjust the display to match the output from the camera.
-

## Transferring images to a computer

Connect the camera using the supplied USB cable. You can then use Nikon NX Studio software to copy pictures to the computer for viewing and editing.

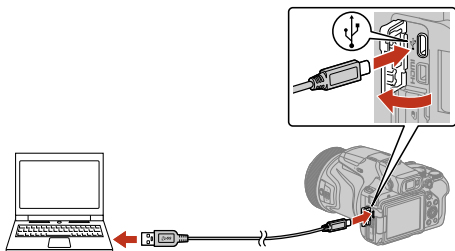

## Installing NX Studio

You will need an Internet connection when installing NX Studio. Visit the Nikon website for system requirements and other information.

- Download the latest NX Studio installer from the website below and follow the on-screen instructions to complete installation.

<https://downloadcenter.nikonimglib.com/>

- Note that you may be unable to download pictures from the camera using earlier versions of NX Studio.

## Copying pictures to a computer using NX Studio

See online help for detailed instructions.

---

## 1 Connect the camera to the computer.

- After turning the camera off and ensuring that a memory card is inserted, connect the supplied USB cable as shown.

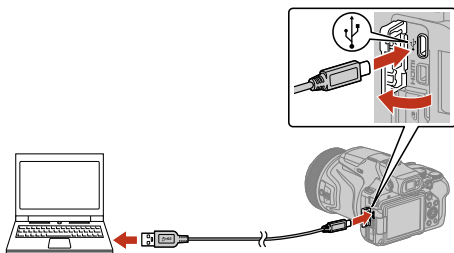

---

## 2 Turn the camera on.

- The Nikon Transfer 2 component of NX Studio will start. Nikon Transfer 2 image transfer software is installed with NX Studio.
- If a message is displayed prompting you to choose a program, select Nikon Transfer 2.
- If Nikon Transfer 2 does not start automatically, launch NX Studio and click the “Import” icon.

### 3 Click [Start Transfer].

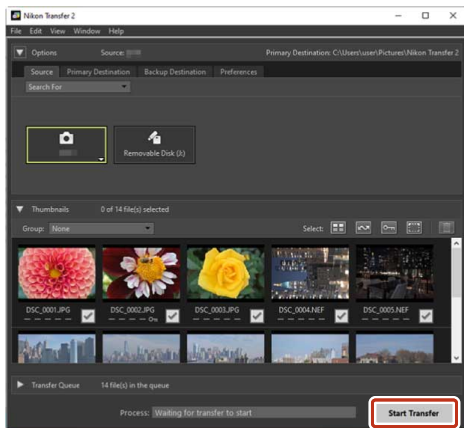

- Pictures on the memory card will be copied to the computer.

### 4 Turn the camera off.

- Disconnect the USB cable when transfer is complete.

## ✔ Windows

Some computers may be configured to display an AutoPlay prompt when the camera is connected.

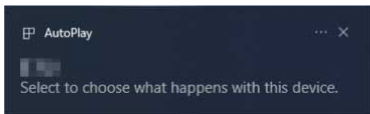

Click the dialog and then click **[Nikon Transfer 2]** to select Nikon Transfer 2.

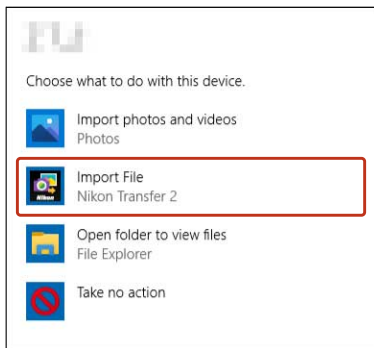

## ✔ macOS

If Nikon Transfer 2 does not start automatically, confirm that the camera is connected and then launch Image Capture (an application that comes with macOS) and select Nikon Transfer 2 as the application that opens when the camera is detected.

## ✔ Transferring videos

Do not attempt to transfer videos from the memory card while it is inserted in a camera of a different make or model. Doing so could result in the videos being deleted without being transferred.

## ✔ Connecting to computers

- Do not turn the camera off or disconnect the USB cable while transfer is in progress.
- Do not use force or attempt to insert the connectors at an angle. Be sure also to keep the connectors straight when disconnecting the cable.
- Always turn the camera off before connecting or disconnecting a cable.
- Disconnect all other USB-powered devices from the computer.  
Connecting the camera and other USB-powered devices to the same computer simultaneously may cause a camera malfunction or excessive power supply from the computer, which could damage the camera or memory card.
- Make sure that the camera battery is sufficiently charged. If the EH-5d AC Adapter and the EP-5C Power Connector (both available separately) are used, this camera can be powered from an electrical outlet. Do not, under any circumstances, use an AC adapter other than the EH-5d. Failure to observe this precaution could result in overheating or damage to the camera.

## ✔ USB hubs

Connect the camera directly to the computer; do not connect the cable via a USB hub or keyboard. Connect the camera to a pre-installed USB port.

---

### **Tip: Using a card reader**

Pictures can also be copied from a memory card inserted in a third-party card reader. You should however check that the card is compatible with the card reader.

---

# Accessories

## List of accessories

Aside from the included accessories, you can use the following available accessories.

Type	Product name
AC adapter	<b>EH-8P AC Adapter</b> The EH-8P can be used to charge the battery inserted in the camera. <ul style="list-style-type: none"><li>• The optional UC-E25 USB Cable (with two Type C connectors) is required for charging the battery using the EH-8P. (The supplied USB cable cannot be used for charging.)</li></ul>
	<b>EH-73P Charging AC Adapter</b> The EH-73P can be used to charge the battery inserted in the camera. <ul style="list-style-type: none"><li>• Use the USB cable supplied with the camera for charging.</li></ul>
	<b>EH-5d AC Adapter and EP-5C Power Connector</b> (□□320)
USB cable	<b>UC-E25 USB Cable</b> A USB cable with two Type C connectors. The UC-E25 USB Cable is required to connect the camera to the EH-8P AC Adapter.

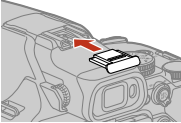
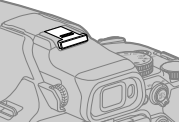
Type	Product name
<p><b>Accessory shoe cover</b></p>	<p><b>BS-1 Accessory Shoe Cover</b> Protects the accessory shoe.</p> <p><b>①</b></p>  <p><b>②</b></p> 
<p><b>Speedlight (external flash unit)</b></p>	<p>See “Speedlights (external flash units)” (□322) for information on compatible Speedlights and how to use them.</p>
<p><b>Filter</b></p>	<ul style="list-style-type: none"> <li>• <b>77mm Neutral Color NC Filter</b> Protects the lens.</li> <li>• <b>77mm Soft Focus Filter</b> Produces a softening effect.</li> <li>• <b>77mm Circular Polarizer II</b> Reduces the effect of light reflected on non-metallic surfaces such as glass and on the surface of water.</li> <li>• When you use the built-in flash with a filter attached, the image periphery may appear dark.</li> </ul>
<p><b>Remote control accessories</b></p>	<p><b>MC-DC2 Remote Cord</b> You can use the MC-DC2 to release the shutter when it is connected to the accessory terminal.</p>

Type	Product name
<b>Remote control accessories</b>	<b>ML-L7 Remote Control</b> (☐325)
<b>Sight</b>	<b>DF-M1 Dot Sight</b> Sight that assists with framing when shooting in a telephoto position, where it is easy to lose sight of the subject.

---

**Tip: Accessories**

- Availability may vary with country or region.
  - See our website or brochures for the latest information.
-

# **EH-5d AC Adapter and EP-5C Power Connector**

When the power connector is inserted into the camera and the AC adapter is connected, the camera can be powered from an electrical outlet. The AC adapter and the power connector are available separately.

## **Attaching the EH-5d AC Adapter and EP-5C Power Connector**

- 1** Open the battery-chamber/memory card slot cover, and remove the battery.
- 2** Open the power connector cover (❶), and insert the power connector with the positive and negative terminals oriented correctly (❸).

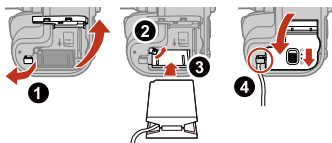

- Fully insert the power connector cable into the slot in the battery chamber (❷), and close the battery-chamber/memory card slot cover. If part of the cable protrudes from the slots, the cover or cable may be damaged when the cover is closed.

- 
- 3** Insert the DC plug of the AC adapter into the DC plug connector of the Power Connector.

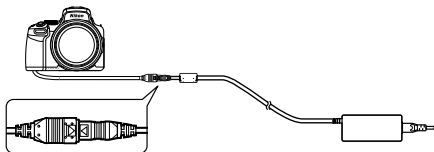

## Speedlights (external flash units)

The following Speedlights can be used with the camera. The standard i-TTL flash function is available.

- SB-5000, SB-700

### ■ Attaching the Speedlight

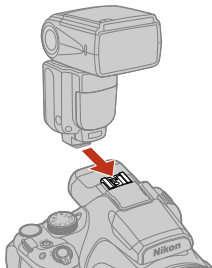

- Do not raise the built-in flash.
- Refer to the documentation provided with your Speedlight for information about attaching the Speedlight.
- Attempting to attach an accessory that does not support this camera may damage the camera and the accessory.

### ✔ Notes about the built-in flash

The built-in flash of this camera cannot be used when a Speedlight is attached.

Do not raise the built-in flash when a Speedlight is attached. Doing so may cause it to hit the Speedlight, resulting in product damage.

### ✔ Notes about third-party flash units

The camera cannot be used with flash units that would apply voltages over 250 V to the camera's X contacts or short-circuit contacts on the accessory shoe. Flash units of other manufacturers (with voltages over 250 V applied to the camera's X sync contact, or causing short circuit at the accessory shoe contact) could not only prevent normal operation, but damage the sync circuitry of the camera or flash.

### ✔ Notes about using Speedlights (external flash units)

If vignetting appears in the captured image, try to put some distance between the camera and the subject or remove the lens hood.

## ■ Functions that can be used in combination with the Speedlight

		SB-5000	SB-700
i-TTL	i-TTL balanced fill-flash	-	-
	Standard i-TTL flash	✔	✔
AA	Auto aperture flash	✔	-
A	Non-TTL auto flash	-	-
M	Manual flash	✔	✔
GN	Distance-priority manual flash	✔	✔
RPT	Repeating flash	✔	-

	SB-5000	SB-700
Red-eye reduction	✓	✓

---

**Tip: Notes about i-TTL flash**

- The monitor preflashes are fired to measure the reflecting light from a subject in order to adjust the flash output of the Speedlight.
  - Standard i-TTL flash: The flash output is adjusted to achieve proper exposure according to the brightness of the main subject without consideration of the background light. This setting is optimal for taking images with emphasis on the main subjects.
- When shooting using i-TTL flash, set the flash control mode of the Speedlight to i-TTL before taking pictures.

**Tip: Notes about Speedlights**

- This camera does not support flash color information communication, Auto FP High-Speed Sync, FV lock, AF-assist illumination for multi-point AF, or the wireless lighting function when using Speedlights.
  - When using the power zoom function with the SB-5000 or SB-700, the zoom head position is automatically set depending on the focal length of the lens.
  - When using a Speedlight, the image periphery may appear dark if the zoom is at the wide-angle position. In such cases, use the wide panel of the SB-5000 or SB-700.
  - When set to STBY (standby), the Speedlight turns on and off at the same time as the camera. Confirm on the Speedlight that the flash-ready indicators are on.
  - Refer to the documentation provided with your Speedlight for more information.
-

## ML-L7 Remote Control

You can pair (☞329) the separately available ML-L7 Remote Control with the camera, and use it to operate the camera. The operations described in “Parts and functions of the remote control (for COOLPIX P1100)”

(☞326) can be performed when shooting with this camera.

- The camera can only be paired with one remote control at a time.  
When the camera is paired with a different remote control, only the most recent paired remote control is enabled.
- Refer to the documentation provided with the ML-L7 Remote Control.

---

### ✔ Notes about connection via HDMI

The remote control cannot be used when the camera and an HDMI-compatible device are connected. Disconnect the connection with the HDMI-compatible device.

---

## Parts and functions of the remote control (for COOLPIX P1100)

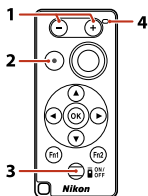

Parts	Function
<b>1</b> - button/+ button	Zooms out when the - button is pressed and zooms in when the + button is pressed, while the shooting screen is displayed.
<b>2</b> Movie recording button	Starts recording a movie when the button is pressed, and stops recording when pressed again.
<b>3</b> Power button	Press the button to turn on the remote control and search for a camera that has already been paired. Press and hold the button (for at least 3 seconds) to search for a new pairing camera. To turn off the remote control, press the button again.
<b>4</b> Status lamp	Indicates the remote control status or shooting session status, based on the color and behavior of the lamp (□329).

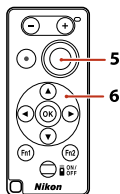

Parts	Function
<b>5</b> <b>Shutter-release button</b>	Functions similarly to the shutter-release button on the camera. <ul style="list-style-type: none"> <li>• Half-press and press-and-hold operations are not available.</li> <li>• When using the self-timer, you can press the button during the countdown to cancel shooting.</li> </ul>
<b>6</b> <b>Multi selector</b>	<ul style="list-style-type: none"> <li>• Functions similarly to the multi selector on the camera, enabling you to configure settings on the shooting screen, such as the flash mode (□122), self-timer (□127), focus mode (□133), and exposure compensation (□144). With some shooting modes and menu settings, it is possible to adjust the effect or move the focus area (□232).</li> <li>• When using manual focus, the focus can be adjusted with ▲▼ (□140).</li> </ul>

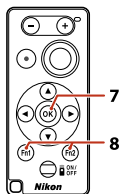

	Parts	Function
7	<b>OK (apply selection) button</b>	Applies the selected item. When adjusting manual focus, press this button to stop focusing.
8	<b>Fn1 (Function 1)/Fn2 (Function 2) buttons</b>	If you press the Fn1 or Fn2 button in <b>P</b> , <b>S</b> , <b>A</b> , <b>M</b> , or <b>U</b> mode, you can quickly configure the pre-saved menu options (☞149).



## ■ Status lamp on the remote control (for COOLPIX P1100)

Color	Status	Description
Green	Flashing about every second	Remote control is searching for a camera that has already been paired.
Green	Flashing quickly (about every 0.5 seconds)	Pairing process is being performed.
Green	Flashing about every 3 seconds	Connection is established between remote control and camera.
Orange	Flashes once	Still image shooting starts.
Orange	Flashes twice	End still image shooting (e.g. shooting with the Time setting).
Red	Flashes once	Movie recording starts.
Red	Flashes twice	Movie recording ends.

## ■ Pairing the camera and remote control

Before using the remote control for the first time, it must be paired with the camera.

**1** Press the MENU button on the camera.

**2** Press the multi selector ◀, use ▲▼ to select  (network menu), and press the  button.

---

### 3 Select [Choose connection], and press the **OK** button.

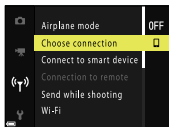

---

### 4 Select [Remote control], and press the **OK** button.

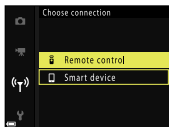

---

### 5 Select [Connection to remote], and press the **OK** button.

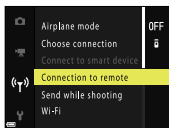

- Pairing is enabled and the camera waits for the connection to be established.
- If you cannot select [**Connection to remote**], set the following in the network menu.
  - [**Airplane mode**]: [**Off**]
  - [**Bluetooth**] → [**Connection**] → [**Enable**]



## 6 Press and hold (for at least 3 seconds) the power button on the remote control.

- Pairing starts for the camera and remote control. During the process, the status lamp on the remote control flashes about every 0.5 seconds.
- When pairing is complete, a connection is established between the camera and the remote control. When you enter shooting mode,  is displayed on the shooting screen.



- If a pairing failure message is displayed, perform the procedure again from step 5.

## Switching the connection to a smart device

- In the Network menu of the camera → **[Choose connection]** ()270), switch the connection from **[Remote control]** to **[Smart device]**.
- When the SnapBridge app is launched on your smart device, and a connection is reestablished between the camera and smart device,  on the shooting screen flashes and then turns on again (if a smart device is paired).
- For connecting to smart devices, see “Connecting to smart devices” ()301).

# If there is a problem

## Troubleshooting

If the camera fails to function as expected, check the following before consulting your retailer or Nikon-authorized service representative.

- Turning off the camera once may solve the issue.
- If you cannot find a relevant entry, also check “Error messages” (□345) or the Nikon website for your region.

## Power, display, settings

---

### ● The camera is on but does not respond.

- Wait for recording to end.
- If the problem persists, turn the camera off.

If the camera does not turn off remove and reinsert the battery or batteries or, if you are using an AC adapter, disconnect and reconnect the AC adapter. Note that although any data currently being recorded will be lost, data that have already been recorded will not be affected by removing or disconnecting the power source.

---

### ● The camera cannot be turned on.

The battery is exhausted (□51, □359).

---

### ● The camera turns off without warning.

- The camera automatically turns off to save power (auto off function) (□64).
  - The camera and battery may not work properly at low temperatures (□359).
  - The inside of the camera has become hot. Leave the camera off until the inside of the camera has cooled, and then try turning it on again.
- 

### ● The monitor or viewfinder is blank.

- The camera is off (□55).

- The battery is exhausted (□51, □359).
  - The camera automatically turns off to save power (auto off function) (□64).
  - You cannot turn on both the monitor and viewfinder at the same time. It may take a while to switch between the monitor and viewfinder.
  - The camera is connected to a TV or computer.
  - Interval timer shooting, [**Multiple exp. Lighten**] scene mode (when [**Star trails**] is set) shooting, or time-lapse movie shooting is in progress, or the camera is capturing images with a long time-exposure using the Bulb setting or Time setting.
- 

### ● **The camera becomes hot.**

The camera may become hot when used for an extended period of time such as to shoot movies, or when used in a hot environment; this is not a malfunction.

---

### ● **The battery inserted in the camera cannot be charged.**

- Confirm all connections (□51).
  - The camera may not charge when connected to a computer for any of the reasons described below.
    - The setup menu → [**Charge by computer**] (□292) is set to [**Off**].
    - If the camera is turned off, charging stops.
    - Battery charging is not possible if the camera's display language and date and time have not been set, or the date and time were reset after the camera's clock battery was exhausted. Either insert the battery in the camera or connect the camera to the AC adapter (available separately) and charge the clock battery.
    - Battery charging may stop when the computer enters sleep mode.
    - Depending on the computer specifications, settings, and status, battery charging may not be possible.
- 

### ● **The monitor is hard to see.**

- Adjust the screen brightness (□277).
- The surrounding area is too bright.
  - Move to a darker place.
  - Use the viewfinder (□66).

---

- **The viewfinder is hard to see.**

- Adjust the diopter of the viewfinder (□□66).
  - Adjust the viewfinder brightness (□□277).
- 

- **🕒 flashes on the screen.**

- The camera clock has not been set. Set the date and time in the setup menu → **[Time zone and date]** (□□274).
  - If the camera clock has not been set, images and movies saved before the clock is set are dated "00/00/0000 00:00" and "01/01/2025 00:00" respectively.
- 

- **Date and time of recording are not correct.**

Set the date and time in the setup menu → **[Time zone and date]** (□□274).  
The camera clock is not as accurate as ordinary watches or clocks.  
Periodically compare the time of the camera clock with that of a more accurate timepiece and reset as required.

---

- **No information displayed on the screen.**

Shooting and photo information may be hidden. Press the **DISP** button until information is displayed (□□41).

---

- **[Date stamp] not available.**

The camera clock has not been set. Set the date and time in the setup menu → **[Time zone and date]** (□□274).

---

- **Date not stamped on images even when [Date stamp] is enabled.**

- The current shooting mode does not support **[Date stamp]** (□□282).
  - A function that restricts the **[Date stamp]** function is enabled (□□156).
  - The date cannot be stamped on movies.
- 

- **Screen for setting time zone and date is displayed when the camera is turned on.**

- The camera settings reset.**

The clock battery is exhausted; all settings were restored to their default values. Configure the camera settings again.

The internal clock battery is used to power the camera clock and to retain certain settings. Charging time of the clock battery takes about 10 hours when you insert the battery into the camera or connect the AC adapter (available separately) to the camera, and the clock battery operates for several days even after the camera battery is removed.

---

● **[Reset file numbering] cannot be done.**

- Although a new folder is created on the memory card by resetting file numbering, etc., if the sequential number of a folder name (which is not displayed on the camera) reaches the upper limit ("999"), reset is not possible. Change the memory card, or use the setup menu → **[Format card]** (□289) to format the memory card.
  - The write-protect switch is locked. Slide the write-protect switch to the "write" position (□48, □361).
- 

● **The camera makes sound.**

When **[Autofocus mode]** is set to **[Full-time AF]** or while in some shooting modes, the camera may produce an audible focusing sound (□237, □251).

---

● **The EN-EL20 Rechargeable Li-ion Battery cannot be used.**

You cannot use the EN-EL20 Rechargeable Li-ion Battery. Use EN-EL20a.

---

## Shooting



---

● **Cannot switch to shooting mode.**

Disconnect the USB cable.

---

● **Cannot take pictures or record movies.**

- When the camera is in playback mode, press the  button, shutter-release button, or  button (□25).
- When menus are displayed, press the **MENU** button (□25).
- When shooting in **[Night portrait]** or **[Backlighting]** (with **[HDR]** set to **[Off]**) scene mode, raise the built-in flash (□64).
- The built-in flash is charging while  is flashing. Wait until charging is complete (□123).

- Insert a memory card with sufficient free space into the camera.
  - The battery is exhausted (☐51, ☐359).
- 

### ● **The camera cannot focus.**

- The subject is too close. Try shooting using the following.
    - [**Close-up**] (☐105) scene mode
    - [**Macro close-up**] (☐132) focus mode
  - Incorrect focus mode setting. Check or change the setting (☐132).
  - The subject is hard to focus on (☐137).
  - Select the setup menu → [**AF assist**] (☐284) → [**Auto**].
  - Subject is not in focus area when the shutter-release button is pressed halfway.
  - The focus-mode selector is set to **MF** (manual focus).
    - To shoot using autofocus, set the focus-mode selector to **AF** (autofocus).
    - To shoot using manual focus, focus manually (☐140).
  - Turn the camera off and then on again.
  - The camera may move slightly when operated, even if it is attached to a tripod, which may interfere with the autofocus.
- 

### ● **Colored stripes appear on the screen when shooting.**

Colored stripes may appear when shooting subjects with repeating patterns (such as window blinds); this is not a malfunction.

The colored stripes will not appear in captured images or recorded movies.

However, when using [**Continuous H: 120 fps**] or [**HS 480/4x**], the colored stripes may be seen in the captured images and recorded movies.

---

### ● **Images are blurred.**

- Use the flash (☐122).
  - Enable vibration reduction. You can also use [**Electronic VR**] when recording movies (☐252, ☐283).
  - Use a tripod to stabilize the camera (using the self-timer setting of [**☺ 10s**] (10 seconds) at the same time is more effective) (☐63, ☐127).
- 

### ● **Bright specks appear in images captured with flash.**

The flash is reflecting off particles in the air. Lower the built-in flash (☐64).

---

● **Flash does not fire.**

- The built-in flash is lowered (□64).
  - A shooting mode where the flash cannot fire is selected (□146, □156).
  - A function that restricts the flash is enabled (□156).
- 

● **Digital zoom cannot be used.**

- The setup menu → [Digital zoom] (□285) → [Off] is selected.
  - Digital zoom cannot be used with certain shooting modes or when using certain settings in other functions (□156, □285).
- 

● **[Image size] not available.**

- A function that restricts the [Image size] option is enabled (□156).
  - When the scene mode is set to [Easy panorama] (□109), the image size is fixed.
- 

● **No sound when the shutter is released.**

- The setup menu → [Sound settings] (□288) → [Shutter sound] → [Off] is selected. No sound is produced with some shooting modes or settings, even when [On] is selected (□156).
- 

● **AF-assist illuminator does not light.**

The setup menu → [AF assist] (□284) → [Off] is selected. AF-assist illuminator may not light depending on the position of the focus area or the current scene mode, even when [Auto] is selected.

---

● **Images appear smeared.**

The lens is dirty. Clean the lens (□363).

---

● **Colors are unnatural.**

White balance or hue is not adjusted properly (□106, □219).

---

● **Randomly spaced bright pixels (“noise”) appear in image.**

The subject is dark and the shutter speed is too slow, or ISO sensitivity is too high. Noise can be reduced by:

- Using the flash (□122).
- Specifying a lower ISO sensitivity setting (□229).

---

### ● Bright spots appear in image.

When shooting at a slow shutter speed in multiple exposure mode, noise (bright spots) may appear in saved images.

---

### ● Images are too dark (underexposed).

- The flash window is blocked (□25).
  - The subject is beyond the range of the flash. Check the range of the flash (□124, □367).
  - Adjust exposure compensation (□144).
  - Increase ISO sensitivity (□229).
  - The subject is backlit.
    - Use the flash (□122).
    - Try the [Backlighting] (□108) scene mode.
- 

### ● Images are too bright (overexposed).

Adjust exposure compensation (□144).

---

### ● Skin tones are not softened.

- In some shooting conditions, facial skin tones may not be softened.
  - For images containing four or more faces, try using the playback menu → [Skin softening] (□259) after shooting.
- 

### ● Saving images takes time.

It may take more time to save images in the following situations:

- When the noise reduction function is in operation
- When shooting with a flash with the flash mode set to  [Auto with red-eye reduction]/[Red-eye reduction]
- When capturing images in the following scene modes:
  - [Noise reduction burst] in [Landscape] or [Close-up]
  - [Hand-held] in [Night landscape]
  - [HDR] is set to [On] in [Backlighting]
  - [Easy panorama]
- When using the Bulb setting or Time setting to capture images with a long time-exposure
- When the shooting menu → [Continuous] is set to [Continuous H: 120 fps] or [Continuous H: 60 fps]

- When using [**Smile timer**] while shooting
  - When using Active D-Lighting while shooting
  - When using multiple exposure while shooting
  - When [**Image quality**] is set to [**RAW**], [**RAW + Fine**], or [**RAW + Normal**]
  - When capturing still images while recording a movie with [**Movie options**] set to [**2160/30p**] or [**2160/25p**]
- 

● **A ring-shaped belt or rainbow-colored stripe appears on the screen or images.**

When shooting with backlighting or when a very strong light source (such as sunlight) is in the frame, a ring-shaped belt or rainbow-colored stripe (ghosting) may occur. Change the position of the light source, or frame the picture so that the light source does not enter the frame, and try again.

---

● **Menu items cannot be selected (displayed in gray).**

**Set features do not work.**

- Some menus are not available while a wireless connection is established. Stop the wireless connection.
  - Some functions cannot be used with other menu settings (☐156).
- 

## **Playback, editing**

---

● **File cannot be played back.**

- This camera may not be able to play back images saved with another make or model of digital camera.
  - This camera cannot play back RAW images or movies saved with another make or model of digital camera.
  - This camera may not be able to play back data edited on a computer.
  - Files cannot be played back during interval timer shooting.
  - The memory card contains no images.
- 

● **Cannot zoom in on image.**

- Playback zoom cannot be used with movies.
- This camera may not be able to zoom in on images captured with another make or model of digital camera.

- When zooming in on a small-sized image, the magnification rate shown on the screen may differ from the actual magnification rate of the image.
- 

● **Cannot edit images.**

- Some images cannot be edited. Images that have already been edited may not be edited again (□173).
  - There is not enough free space on the memory card.
  - This camera is unable to edit images captured with other cameras.
  - Editing functions used for images are not available for movies.
- 

● **Cannot rotate image.**

This camera cannot rotate images captured with another make or model of digital camera.

---

## **TVs, computers, printers**

---

● **Images are not displayed on the TV.**

- A computer is connected to the camera.
  - The memory card contains no images.
- 

● **Nikon Transfer 2 does not start when the camera is connected to a computer.**

- The camera is off.
  - The battery is exhausted (□292).
  - The USB cable is not correctly connected (□312).
  - The camera is not recognized by the computer.
  - The computer is not set to start Nikon Transfer 2 automatically. For more information about Nikon Transfer 2, refer to Nikon Transfer 2's online help.
- 

● **Images saved in the camera are not displayed on a connected smart device or computer.**

If the number of images saved on a memory card in the camera exceeds 10,000, images captured thereafter may not be displayed in a connected device.

- Reduce the number of images saved on the memory card. Copy the necessary images to a computer, etc.
- 

- **Cannot connect to a printer.**

This camera does not support printer connections (□174).

---

## **Smart devices, SnapBridge app, ML-L7 Remote Control**

---

- For more information about the SnapBridge app, see also the online help for the SnapBridge app (<https://nikonimglib.com/snbr/onlinehelp/en/index.html>).
  - For more information about the ML-L7 Remote Control (available separately), see the documentation provided with the remote control.
- 

- **Cannot select [Connect to smart device].**

### **Cannot pair with a smart device using [Connect to smart device].**

- When establishing a wireless connection for the first time, refer to the online help for the SnapBridge app.
  - Use a sufficiently charged battery.
  - Insert a memory card with sufficient free space into the camera.
  - Disconnect the HDMI cable or USB cable.
  - Set the following in the **[Network menu]** (□270) in the camera.  
**[Airplane mode]: [Off]**  
**[Choose connection]: [Smart device]**  
**[Bluetooth] → [Connection]: [Enable]**
  - Enable Bluetooth and the location data functions on the smart device.
- 

- **Paired smart devices are not connected through Bluetooth automatically.**

- Set the following in the **[Network menu]** (□270) in the camera.  
**[Airplane mode]: [Off]**  
**[Choose connection]: [Smart device]**  
**[Bluetooth] → [Connection]: [Enable]**

- If the camera is paired with multiple smart devices, select the smart device you want to connect in the **[Network menu]** (☐270) → **[Bluetooth]** → **[Paired devices]** in the camera.
  - After performing the setup menu → **[Reset all]** or **[Network menu]** (☐270) → **[Restore default settings]** in the camera, unpair in SnapBridge and then pair again.
  - If multiple cameras are registered in the SnapBridge app, switch to the camera you want to connect using the SnapBridge app.
- 

● **Cannot upload images to a smart device that is connected with the SnapBridge app.**

- You can upload automatically through the auto link feature only when connected through Bluetooth. To upload automatically, set the following.

In the camera, **[Network menu]** (☐270) → **[Send while shooting]** → **[Still images]: [Yes]**

Enable the auto download function of the SnapBridge app.

If **[Network menu]** (☐270) → **[Bluetooth]** → **[Send while off]** → **[Off]** is selected in the camera, change the setting to **[On]** or turn on the camera.

- When there is a large number of images to upload during Bluetooth communication, communication may be disconnected while uploading. Image upload resumes after a while if the camera's **[Network menu]** (☐270) → **[Bluetooth]** → **[Send while off]** is set to **[On]**. To resume quickly, turn the camera off and then on again.
  - Insert a memory card into the camera.
  - You may not be able to upload images or uploading may be canceled while the camera is being operated.
- 

● **Cannot download the original files of still images on the smart device that is connected with the SnapBridge app.**

For **[Send while shooting]** and **[Mark for upload]** in the camera, still images are uploaded at an image size of up to 2 megapixels. To upload original files, use the image download function of the SnapBridge app.

---

● **Cannot perform remote photography from a smart device that is connected with the SnapBridge app.**

- You cannot perform remote photography without a memory card inserted into the camera. Insert the memory card.
- You may not be able to perform remote photography while the camera is being operated.

---

● **Communication quality is poor or image upload speed is extremely slow when using a Wi-Fi connection with the SnapBridge app.**

On the camera, try changing the channel in the [Network menu] (□270) → [Wi-Fi] → [Network settings].

---

● **Images saved in the camera are not displayed on a connected smart device or computer.**

If the number of images saved on a memory card in the camera exceeds 10,000, images captured thereafter may not be displayed in a connected device.

- Reduce the number of images saved on the memory card. Copy the necessary images to a computer, etc.

---

● **Cannot select [Connection to remote].  
Cannot use [Connection to remote] to pair with the ML-L7 Remote Control.**

- Use a sufficiently charged battery.
- Set the following in the [Network menu] (□270) in the camera.  
[Choose connection]: [Remote control]  
[Airplane mode]: [Off]  
[Bluetooth] → [Connection]: [Enable]

---

● **The camera does not respond when operating the ML-L7 Remote Control.**

- The camera is not connected to the ML-L7 Remote Control (available separately). Press the power button on the remote control to establish

the connection. If  is not displayed on the shooting screen, perform pairing again (□□329).

- The remote control can be used only for shooting operations or Fn button operations (□□325).
  - The remote control cannot be used when the camera and an HDMI-compatible device are connected. Disconnect the connection with the HDMI-compatible device.
-

## Error messages

Check the following if an error message is displayed.

- If you cannot find a relevant entry, also check “Troubleshooting” (□332).

---

- **Battery temperature is elevated. The camera will turn off.**  
**The camera will turn off to prevent overheating.**

The camera turns off automatically. Wait until the camera or battery temperature has cooled before resuming use.

---

- **Memory card is write protected.**

The write-protect switch is locked. Unlock it (□361).

---

- **This card cannot be used.**  
**This card cannot be read.**

An error occurred while accessing the memory card.

- Use an approved memory card (□49).
- Check that the terminals are clean.
- Confirm that the memory card is correctly inserted (□48).

---

- **Card is not formatted. Format card?**

The memory card has not been formatted for use in the camera.

Formatting deletes all data saved on the memory card. If you need to keep copies of any images, make sure to select **[No]** and save the copies to a computer or other medium before formatting the memory card. Select **[Yes]** and press the **(OK)** button to format the memory card (□361).

---

- **Out of memory.**

Delete images or insert a new memory card.

---

- **Image cannot be saved.**

- An error occurred while saving the image. Change the memory card, or use **[Format card]** (□289) to format the memory card.
- The camera has run out of file numbers. Change the memory card, or use **[Format card]** (□289) to format the memory card.

---

● **Image cannot be modified.**

Check that the images can be edited (□173, □340).

---

● **Cannot record movie.**

A time-out error occurred while saving the movie on the memory card.

Select a memory card with a faster write speed (□49, □178).

---

● **Cannot reset file numbering.**

File numbering cannot be reset because the sequential number of a folder has reached the upper limit.

Change the memory card, or use **[Format card]** (□289) to format the memory card.

---

● **Set the focus-mode selector to MF.**

When **[Clean HDMI output]** (□291) is set to **[On]** and the camera is connected to an HDMI-compatible device, set the focus-mode selector to **MF** (□25).

---

● **Memory contains no images.**

Insert a memory card that contains images.

---

● **File contains no image data.**

The file was not created or edited with this camera. The file cannot be viewed on this camera.

View the file using a computer or the device used to create or edit this file.

---

● **All images are hidden.**

- There are no images available for a slide show, etc.
  - There are no images that can be displayed on the image selection screen for deletion.
- 

● **This image cannot be deleted.**

The image is protected.

Disable protection (□264).

---

---

- **Raise the flash.**

When shooting in [**Night portrait**] or [**Backlighting**] (with [**HDR**] set to [**Off**]) scene mode, raise the built-in flash before shooting.

---

- **Turn the camera off and then on again.**

An error occurred in lens operation.

Do not apply excessive force on the lens.

If you turn the camera off and then on again, lens operation will return to normal (□332).

If the error persists even after turning the camera off and then on again, contact your retailer or Nikon-authorized service representative.

---

- **Speedlight setting error**

A Speedlight function that cannot be used with the camera is set. Change the Speedlight setting (□322).

---

- **System error**

An error occurred in the camera's internal circuitry. Turn the camera off, remove and reinsert the battery, and turn the camera on (□332).

If the error persists, contact your retailer or Nikon-authorized service representative.

---

- **Clean HDMI output enabled. Select "Movie manual" mode.**

When [**Clean HDMI output**] is set to [**On**] and the camera is connected to an HDMI-compatible device, rotate the mode dial to Movie manual (□183).

---

# Technical notes

## Compliance information

### ■ Notes about wireless communication function

#### ● Use restriction

The use of wireless devices may be prohibited in some countries or regions. Familiarize yourself with and obey all applicable local regulations.

The Bluetooth transmitter in this device operates in the 2.4 GHz band.

#### ● Security note

Although one of the benefits of this product is that it allows others to freely connect for the wireless exchange of data anywhere within its range, the following may occur if security is not enabled:

- **Data theft:** Malicious third-parties may intercept wireless transmissions to steal user IDs, passwords, and other personal information.
- **Unauthorized access:** Unauthorized users may gain access to the network and alter data or perform other malicious actions. Note that due to the design of wireless networks, specialized attacks may allow unauthorized access even when security is enabled.
- **Unsecured networks:** Connecting to open networks may result in unauthorized access. Use secure networks only.
- **Configuring the settings of the security features that are normally included in Wi-Fi (wireless LAN) products will reduce the possibility that the problems described above will occur.**
- **You should fully understand the problems that may occur if you use a product without configuring security settings. It is your responsibility**

to configure security settings at your own discretion before using the product.

- **Precautions when exporting or carrying this product abroad**

This product is controlled by the United States Export Administration Regulations (EAR). The permission of the United States government is not required for export to countries other than the following, which as of this writing are subject to embargo or special controls: Cuba, Iran, North Korea, Sudan, and Syria (list subject to change).

## ■ Notice for customers in the U.S.A.

- **Federal Communications Commission (FCC) statement**

This device complies with part 15 of the FCC Rules. Operation is subject to the following two conditions: (1) This device may not cause harmful interference, and (2) this device must accept any interference received, including interference that may cause undesired operation.

- **FCC Class B Statement**

This equipment has been tested and found to comply with the limits for a Class B digital device, pursuant to Part 15 of the FCC rules. These limits are designed to provide reasonable protection against harmful interference in a residential installation. This equipment generates, uses, and can radiate radio frequency energy and, if not installed and used in accordance with the instructions, may cause harmful interference to radio communications. However, there is no guarantee that interference will not occur in a particular installation. If this equipment does cause harmful interference to radio or television reception, which can be determined by turning the equipment off and on, the user is encouraged to try to correct the interference by one or more of the following measures:

- Reorient or relocate the receiving antenna.
- Increase the separation between the equipment and receiver.

- Connect the equipment into an outlet on a circuit different from that to which the receiver is connected.
- Consult the dealer or an experienced radio/television technician for help.



**Nikon**  
COOLPIX P1100

#### ● **FCC caution**

The FCC requires the user to be notified that any changes or modifications made to this device that are not expressly approved by Nikon Corporation may void the user's authority to operate the equipment.

This transmitter must not be co-located or operated in conjunction with any other antenna or transmitter.

#### ● **FCC RF exposure statement**

The available scientific evidence does not show that any health problems are associated with using low power wireless devices. There is no proof, however, that these low power wireless devices are absolutely safe. Low power Wireless devices emit low levels of radio frequency energy (RF) in the microwave range while being used. Whereas high levels of RF can produce health effects (by heating tissue), exposure of low-level RF that does not produce heating effects causes no known adverse health effects. Many studies of low-level RF exposures have not found any biological effects. Some studies have suggested that some biological effects might occur, but such findings have not been confirmed by additional research. This product has been tested and found to comply with FCC radiation exposure limits set forth for an uncontrolled environment and meets the FCC radio frequency (RF) Exposure Guidelines. Please refer to the SAR test report that was uploaded to FCC website.

- **CAUTION**

Interface cables (when interface cables are supplied)

Use only the interface cables supplied with your camera. Using other interface cables may exceed the limits of Class B Part 15 of the FCC rules. If you have lost a cable or the cable has been damaged, contact the seller or Nikon Inc.

Nikon Inc., 1300 Walt Whitman Road, Melville,

New York 11747-3064, U.S.A.

Tel.: 631-547-4200

## ■ Notice for customers in Canada

- **Innovation, Science and Economic Development Canada (ISED) statement**

This device complies with Innovation, Science and Economic Development Canada's licence-exempt RSS(s). Operation is subject to the following two conditions: (1) this device may not cause harmful interference, and (2) this device must accept any interference received, including interference that may cause undesired operation.

- **ISED compliance label**

CAN ICES-003(B) / NMB-003(B)

- **ISED RF exposure statement**

The available scientific evidence does not show that any health problems are associated with using low power wireless devices. There is no proof, however, that these low power wireless devices are absolutely safe. Low power Wireless devices emit low levels of radio frequency energy (RF) in the microwave range while being used. Whereas high levels of RF can produce health effects (by heating tissue), exposure of low-level RF that does not produce heating effects causes no known adverse health effects. Many studies of low-level RF exposures have not found any biological effects. Some studies have suggested that some

biological effects might occur, but such findings have not been confirmed by additional research. This product has been tested and found to comply with ISED radiation exposure limits set forth for an uncontrolled environment and meets RSS-102 of the ISED radio frequency (RF) Exposure rules.

## ■ Notice for customers in Europe and in countries complying with the EU legislation

### ● Declaration of conformity

Hereby, Nikon Corporation declares that the radio equipment type COOLPIX P1100 is in compliance with Directive 2014/53/EU.



The full text of the EU declaration of conformity is available at the following internet address:

[https://imaging.nikon.com/imaging/support/pdf/DoC\\_N2323.pdf](https://imaging.nikon.com/imaging/support/pdf/DoC_N2323.pdf)

### ● Use restriction in Europe

#### Wi-Fi

- **Operating frequency:** 2412–2462 MHz (1-11 channels)
- **Maximum output power (EIRP):** 6.0 dBm

#### Bluetooth

- **Operating frequency:**
  - Bluetooth: 2402–2480 MHz
  - Bluetooth Low Energy: 2402–2480 MHz
- **Maximum output power (EIRP):**
  - Bluetooth: 4.2 dBm
  - Bluetooth Low Energy: 4.2 dBm

### ● Standby power consumption

This product complies with the implementation measures (standby and off mode, and electric power consumption of electrical and electronic

household and office equipment) adopted under the Ecodesign Directive 2009/125/EC.

- Standby/off mode: less than 0.5 W

#### ● When using a charging AC adapter

When using a charging AC adapter to charge this camera, check that it conforms to the following standards.

The power delivered by the charger must be between min 2.5 Watts required by the radio equipment, and max 4.5 Watts in order to achieve the maximum charging speed.

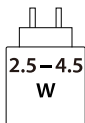

#### ● Disposal information

**CAUTION:** RISK OF EXPLOSION IF BATTERY IS REPLACED BY AN INCORRECT TYPE. DISPOSE OF USED BATTERIES ACCORDING TO THE INSTRUCTIONS.

This symbol indicates that electrical and electronic equipment is to be collected separately.



- This product is designated for separate collection at an appropriate collection point. Do not dispose of as household waste.
- Separate collection and recycling help conserve natural resources and prevent negative consequences for human health and the environment that might result from incorrect disposal.

- For more information, contact the retailer or the local authorities in charge of waste management.

This symbol on the battery indicates that the battery is to be collected separately.



- All batteries, whether marked with this symbol or not, are designated for separate collection at an appropriate collection point. Do not dispose of as household waste.
- For more information, contact the retailer or the local authorities in charge of waste management.

## ■ Notice for customers in UK

### ● Declaration of conformity

Hereby, Nikon Corporation declares that the radio equipment type COOLPIX P1100 is in compliance with Radio Equipment Regulations 2017.



The full text of the UKCA declaration of conformity is available at the following internet address:

[https://imaging.nikon.com/imaging/support/pdf/UKCA\\_DoC\\_N2323.pdf](https://imaging.nikon.com/imaging/support/pdf/UKCA_DoC_N2323.pdf)

### ● Use restriction in the UK

#### Wi-Fi

- **Operating frequency:** 2412–2462 MHz (1-11 channels)
- **Maximum output power (EIRP):** 6.0 dBm

#### Bluetooth

- **Operating frequency:**
  - Bluetooth: 2402–2480 MHz
  - Bluetooth Low Energy: 2402–2480 MHz
- **Maximum output power (EIRP):**
  - Bluetooth: 4.2 dBm
  - Bluetooth Low Energy: 4.2 dBm

### ● **Compliance with the UK PSTI Act 2022**

This product complies with the UK PSTI Act 2022 and the statement of compliance and security update period is available at the following internet address:

[https://www.nikonimagsupport.com/eu/BV\\_article?  
lang=en\\_GB&articleNo=000066765](https://www.nikonimagsupport.com/eu/BV_article?lang=en_GB&articleNo=000066765)

## ■ **Notice for customers in Singapore**

Trade Name: ***Nikon***  
Model: COOLPIX P1100

This device complies with radio-frequency regulations. The content of certification labels not affixed to the device is given below.

Complies with  
IMDA Standards  
DA103423

## ■ **Notice for customers in Nigeria**

Connection and use of this communications  
equipment is permitted by the Nigerian  
Communications Commission

## ■ Notice for customers in Thailand

เครื่องโทรคมนาคมและอุปกรณ์นี้ มีความสอดคล้องตามมาตรฐานหรือข้อกำหนดทางเทคนิคของ กสทช.

## ■ Notice for customers in Oman



Oman-TRA
D202897
TRA/TA-R/20231/2024



## ■ Conformity marking

The standards with which the camera complies can be viewed using the [Conformity marking] option in the setup menu.

COOLPIX P1100 Model Name: N2323

## Caring for the product

Observe the precautions described below in addition to the warnings in “For your safety” (☞16) when using or storing the device.

### The camera

- **Do not apply strong impact to the camera**

The product may malfunction if subjected to strong shock or vibration. In addition, do not touch or apply force to the lens.

- **Keep dry**

The device will be damaged if immersed in water or subjected to high humidity.

- **Do not disassemble**

Do not, under any circumstances, disassemble the camera because it is composed of many precise circuits.

- **Avoid sudden changes in temperature**

Sudden changes in temperature, such as when entering or leaving a heated building on a cold day, can cause condensation to form inside the device. To prevent condensation, place the device in a carrying case or a plastic bag before exposing it to sudden changes in temperature.

- **Keep away from strong magnetic fields**

Do not use or store this device in the vicinity of equipment that generates strong electromagnetic radiation or magnetic fields. Doing so could result in loss of data or camera malfunction.

- **Do not point the lens at the sun**

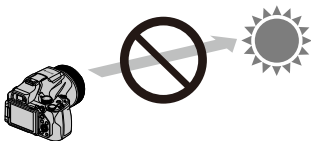

Avoid pointing the lens at the sun or other strong light sources when shooting or when leaving the camera unattended without a lens cap. Strong light sources such as sunlight are concentrated through the lens, which may cause deformation of the internal parts of the lens or discoloration or burn-in on the image sensor. The camera may be damaged even when the lens is pointed toward the sun for a few seconds, particularly when the lens is in a telephoto position.

The camera may not be able to perform exposure control when the internal parts of the lens are deformed.

Unevenness may appear in images when discoloration or burn-in occurs on the image sensor.

It is recommended that you attach the lens cap when you are not using the camera.

- **Lasers and other bright light sources**

Do not direct lasers or other extremely bright light sources toward the lens, as this could damage the camera's image sensor.

- **Turn the product off before removing or disconnecting the power source or memory card**

Do not remove the battery while the product is on, or while images are being saved or deleted. Forcibly cutting power in these circumstances could result in loss of data or in damage to the memory card or internal circuitry.

- **Notes about the monitor**

- Monitors (including electronic viewfinders) are constructed with extremely high precision; at least 99.99% of pixels are effective, with no more than

0.01% being missing or defective. Hence while these displays may contain pixels that are always lit (white, red, blue, or green) or always off (black), this is not a malfunction and has no effect on images recorded with the device.

- Images in the monitor may be difficult to see under bright lighting.
- Do not apply pressure to the monitor, as this could cause damage or malfunction. Should the monitor break, care should be taken to avoid injury caused by broken glass and to prevent the liquid crystal from the display touching the skin or entering the eyes or mouth.

## **The battery**

### **• Precautions for use**

- Note that the battery may become hot after use.
- Do not use the battery at ambient temperatures below 0°C (32°F) or above 40°C (104°F) as this could cause damage or malfunction.
- If you notice any abnormalities such as excessive heat, smoke, or an unusual smell coming from the battery, immediately discontinue use and consult your retailer or Nikon-authorized service representative.
- After removing the battery from the camera, put the battery in a plastic bag, etc. in order to insulate it.

### **• Charging the battery**

Check the battery level before using the camera and replace or charge the battery if necessary.

- Charge the battery indoors with an ambient temperature of 5°C to 35°C (41°F to 95°F) before use.
- A high battery temperature may prevent the battery from charging properly or completely, and may reduce battery performance. Note that the battery may become hot after use; wait for the battery to cool before charging. When charging the battery inserted into this camera using the AC adapter or a computer, the battery is not charged at battery temperatures below 0°C (32°F) or above 50°C (122°F).
- Do not continue charging once the battery is fully charged as this will result in reduced battery performance.

- The battery temperature may increase during charging. However, this is not a malfunction.

- **Carrying spare batteries**

Whenever possible, carry fully charged spare batteries when taking pictures on important occasions.

- **Using the battery when cold**

On cold days, the capacity of batteries tends to decrease. If an exhausted battery is used at a low temperature, the camera may not turn on. Keep spare batteries in a warm place and exchange as necessary. Once warmed, a cold battery may recover some of its charge.

- **Battery terminals**

Dirt on the battery terminals may prevent the camera from functioning. Should the battery terminals become dirty, wipe them off with a clean, dry cloth before use.

- **Charging an exhausted battery**

Turning the camera on or off while an exhausted battery is inserted in the camera may result in reduced battery life. Charge the exhausted battery before use.

- **Storing the battery**

- Always remove the battery from the camera when it is not being used. Minute amounts of current are drawn from the battery while it is in the camera, even when not in use. This may result in excessive battery drain and complete loss of function.
- Batteries in long-term storage should be charged to about 50% at least once a year. Do not charge the battery to 100% before returning it to storage. A fully-exhausted battery will charge to around 50% in about half the time needed to charge it to 100%.
- Put the battery in a plastic bag, etc. in order to insulate it and store it in a cool place. The battery should be stored in a dry location with an ambient temperature of 15°C to 25°C (59°F to 77°F). Do not store the battery in hot or extremely cold locations.

## ● Battery life

A marked drop in the time a fully charged battery retains its charge, when used at room temperature, indicates that the battery needs to be replaced. Purchase a new battery.

## ● Recycling used batteries

Recycle rechargeable batteries in accord with local regulations, being sure to first insulate the terminals with tape.

# Memory cards

## ● Precautions for use

- Use only Secure Digital memory cards (SD49).
- Be sure to follow the precautions described in the documentation included with the memory card.
- If the write-protect switch of the memory card is locked, you cannot shoot, delete images, or format the memory card.

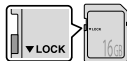

- Do not put labels or stickers on memory cards.

## ● Formatting

- Do not format the memory card using a computer.
- The first time you insert a memory card that has been used in another device into this camera, be sure to format it with this camera. We recommend formatting new memory cards with this camera before using them with this camera.
- **Note that formatting a memory card permanently deletes all images and other data on the memory card.** Be sure to make copies of any images you wish to keep before formatting the memory card.
- If the message [**Card is not formatted. Format card?**] is displayed when the camera is turned on, the memory card must be formatted. If there is data that you do not want to delete, select [**No**]. Copy the necessary data to a computer, etc. If you want to format the memory card, select [**Yes**]. The

confirmation dialog will be displayed. To start formatting, press the **OK** button.

- Do not perform the following during formatting, while data is being written to or deleted from the memory card, or during data transfer to a computer. Failure to observe this precaution could result in the loss of data or in damage to the camera or memory card:
  - Open the battery-chamber/memory card slot cover to remove/insert the battery or memory card.
  - Turn off the camera.
  - Disconnect the AC adapter.

# Cleaning and storage

## Cleaning

Do not use alcohol, thinner, or other volatile chemicals.

- **Lens/viewfinder:**

Avoid touching glass parts with your fingers. Remove dust or lint with a blower (typically a small device with a rubber bulb attached to one end that is pumped to produce a stream of air out the other end). To remove fingerprints or other stains that cannot be removed with a blower, wipe the lens with a soft cloth, using a spiral motion that starts at the center of the lens and working toward the edges. If this fails, clean the lens using a cloth lightly dampened with commercial lens cleaner.

- **Monitor:**

Remove dust or lint with a blower. To remove fingerprints and other stains, clean the monitor with a soft, dry cloth, being careful not to apply pressure.

- **Body:**

- Use a blower to remove dust, dirt, or sand, then wipe gently with a soft, dry cloth.
- After using the camera at the beach or other sandy or dusty environment, wipe off any sand, dust, or salt with a dry cloth lightly dampened with fresh water and dry thoroughly.

**Note that foreign matter inside the camera could cause damage not covered by the warranty.**

## Storage

Remove the battery if the camera will not be used for an extended period.

To prevent mold or mildew, take the camera out of storage at least once a month. Turn the camera on and release the shutter a few times before putting the camera away again.

Do not store the camera in any of the following locations:

- Places that are poorly ventilated or subject to humidity of over 60%
- Places exposed to temperatures above 50°C (122°F) or below -10°C (14°F)
- Places next to equipment that produces strong electromagnetic fields, such as televisions or radios

For storing the battery, follow the precautions in “Storing the battery” (□□360).

# File names

Files saved with this camera are assigned file names as follows.

DSCN0001.JPG

①

②

③

Item	Description
① Identifier	<p>Not shown on the screen of the camera.</p> <ul style="list-style-type: none"><li>• DSCN: Original still images, movies, still images created by the movie editing function</li><li>• RSCN: Cropped copies</li><li>• SSCN: Small picture copies</li><li>• FSCN: Images created by an image editing function other than crop and small picture, movies created by the movie editing function</li></ul>
② File number	<p>Assigned in ascending order, starting with "0001" and ending with "9999."</p> <ul style="list-style-type: none"><li>• A new folder is created each time a series of images are captured using interval timer shooting, and the images are saved in that folder with file numbers starting with "0001."</li></ul>
③ Extension	<p>Indicates file format.</p> <ul style="list-style-type: none"><li>• .JPG: JPEG still images</li><li>• .NRW: RAW still images</li><li>• .MP4: Movies</li></ul>

---

## ✔ Notes

When images are captured with the **[Image quality]** setting set to **[RAW + Fine]** or **[RAW + Normal]**, the RAW and JPEG images that are saved at the same time are assigned the same identifier and file number. The pair of images is saved in the same folder, and is counted as one file.

---

# Specifications

## Nikon COOLPIX P1100 Digital Camera

Type	
Type	Compact digital camera

Number of effective pixels	
Number of effective pixels	16.0 million (Image processing may reduce the number of effective pixels.)

Image sensor	
Type	6.2 × 4.6 mm (1/2.3-in. type) CMOS
Total pixels	Approx. 16.79 million

Lens	
Lens	NIKKOR lens with 125× optical zoom
Focal length	4.3–539 mm (angle of view equivalent to that of 24–3000 mm lens in 35mm [135] format)
f/-number	f/2.8–8
Construction	17 elements in 12 groups (5 ED lens elements and 1 super ED lens element)

### Digital zoom magnification

<b>Digital zoom magnification</b>	Up to 4× (angle of view equivalent to that of approx. 12000 mm lens in 35mm [135] format) Up to 3.6× when recording movies with [2160/30p] (4K UHD) or [2160/25p] (4K UHD)
-----------------------------------	---

### Vibration reduction

<b>Vibration reduction</b>	Lens shift (still images) Combination of lens shift and electronic VR (movies)
----------------------------	---

### Autofocus (AF)

<b>Type</b>	Contrast-detect AF
<b>Focus range</b>	<ul style="list-style-type: none"><li>• [W]: Approx. 30 cm (1 ft)–∞, [T]: Approx. 7.0 m (23 ft)–∞</li><li>• Macro close-up: [W]: Approx. 1 cm (0.4 in.)–∞, [T]: Approx. 7.0 m (23 ft)–∞</li></ul> (All distances measured from center of front surface of lens)
<b>Focus-area selection</b>	Target finding AF, face priority, manual (spot), manual (normal), manual (wide), subject tracking

### Viewfinder

<b>Viewfinder</b>	Electronic viewfinder, 1 cm (0.39-in.), approx. 2359k-dot OLED with the diopter adjustment function (-3 – +3 m-1)
<b>Frame coverage (shooting mode)</b>	Approx. 99% horizontal and vertical (compared to actual picture)

## Viewfinder

<b>Frame coverage (playback mode)</b>	Approx. 100% horizontal and vertical (compared to actual picture)
---------------------------------------	---

## Monitor

<b>Monitor</b>	8.1 cm (3.2-in.), approx. 921k-dot (RGB), wide viewing angle TFT LCD with anti-reflection coating and 5-level brightness adjustment, vari-angle TFT LCD
<b>Frame coverage (shooting mode)</b>	Approx. 99% horizontal and vertical (compared to actual picture)
<b>Frame coverage (playback mode)</b>	Approx. 100% horizontal and vertical (compared to actual picture)

## Storage

<b>Media<sup>1</sup></b>	SD/SDHC/SDXC memory card
<b>File system</b>	DCF and Exif 2.31 compliant
<b>File formats</b>	Still images: JPEG, RAW (NRW) (Nikon's own format) Movies: MP4 (Video: H.264/MPEG-4 AVC, Audio: AAC stereo)

## Image size

<b>Still image</b>	16 M [4608×3456], 8 M [3264×2448], 4 M [2272×1704], 2 M [1600×1200], 16:9 12 M [4608×2592], 3:2 14 M [4608×3072], 1:1 12 M [3456×3456]
--------------------	--

Image size	
<b>Movie</b>	2160/30p (4K UHD), 2160/25p (4K UHD), 1080/30p, 1080/25p, 1080/60p, 1080/50p, 720/30p, 720/25p, 720/60p, 720/50p, HS 480/4x, HS 720/2x, HS 1080/0.5x
ISO sensitivity (Standard output sensitivity)	
<b>ISO sensitivity (Standard output sensitivity)</b>	<ul style="list-style-type: none"> <li>• ISO 100–1600</li> <li>• The lowest ISO sensitivity in Movie manual mode is ISO 125.</li> <li>• [3200] and [6400] are available when using <b>P</b>, <b>S</b>, <b>A</b>, <b>M</b>, <b>U</b>, or Movie manual mode</li> </ul>
Exposure	
<b>Metering mode</b>	Matrix, center-weighted, spot
<b>Exposure control</b>	Programmed auto exposure with flexible program, shutter-priority auto, aperture-priority auto, manual, exposure bracketing, exposure compensation (–2.0 – +2.0 EV in steps of 1/3 EV)
Shutter	
<b>Type</b>	Mechanical and CMOS electronic shutter
<b>Speed</b>	<ul style="list-style-type: none"> <li>• 1/4000 (at wide-angle position, with largest f-number setting (smallest aperture))–1 s</li> <li>• 1/4000 (at wide-angle position, with largest f-number setting (smallest aperture))–30 s (when ISO sensitivity is 100 in <b>M</b> mode)</li> <li>• Bulb and Time setting (can be set when ISO sensitivity is 100 in <b>M</b> mode): Up to 60 seconds</li> <li>• 1/8000 –1/30 s (when recording movies)</li> </ul>

<b>Shutter</b>	
<b>Flash sync speed</b>	Synchronizes with all shutter speeds
<b>Aperture</b>	
<b>Aperture</b>	Electronically-controlled 7-blade iris diaphragm
<b>Range</b>	10 steps of 1/3 EV (W) ( <b>A</b> , <b>M</b> mode)
<b>Self-timer</b>	
<b>Self-timer</b>	Can be selected from 10 s and 3 s
<b>Flash</b>	
<b>Range of built-in flash (approx.) (ISO sensitivity: [Auto])</b>	[W]: 0.3–10 m (12 in.–33 ft) 5.0–6.6 m (16 ft 5 in.–21 ft) (a focal length equivalent to that of a 2000 mm lens in 35mm [135] format) · With a focal length equivalent to that of a lens longer than 2000 mm in 35mm [135] format: Outside of flash range
<b>Flash control</b>	TTL auto flash with monitor preflashes
<b>Flash exposure compensation</b>	In steps of 1/3 EV in the range between –2 and +2 EV
<b>Accessory shoe</b>	
<b>Accessory shoe</b>	ISO 518 hot-shoe with sync and data contacts and safety lock

<b>Interface</b>	
<b>USB connector</b>	Type C connector, Hi-Speed USB
<b>HDMI output connector</b>	HDMI micro connector (Type D)
<b>Accessory terminal</b>	Support for MC-DC2 Remote Cord (available separately)
<b>External microphone connector</b>	Stereo mini-pin jack (3.5 mm diameter; plug-in power supported)

<b>Wi-Fi (Wireless LAN)</b>	
<b>Standards</b>	IEEE 802.11b/g (standard wireless LAN protocol)
<b>Operating frequency</b>	2412–2462 MHz (1-11 channels)
<b>Maximum output power</b>	6.0 dBm (EIRP)
<b>Authentication</b>	Open system, WPA2-PSK, WPA3-SAE

<b>Bluetooth</b>	
<b>Communication protocols</b>	Bluetooth Specification Version 5.2
<b>Operating frequency</b>	Bluetooth: 2402–2480 MHz Bluetooth Low Energy: 2402–2480 MHz
<b>Maximum output power</b>	Bluetooth: 4.2 dBm (EIRP) Bluetooth Low Energy: 4.2 dBm (EIRP)

### Power sources

<b>Power sources</b>	One EN-EL20a Rechargeable Li-ion Battery (included) EH-5d AC Adapter; requires EP-5C Power Connector (available separately)
----------------------	---

### Charging time

<b>Charging time</b>	Approx. 3 h (when using the optional EH-8P AC Adapter with the optional UC-E25 USB Cable and when no charge remains)
----------------------	--

### Battery life<sup>2</sup>

<b>Still images</b>	Approx. 260 shots when using EN-EL20a
<b>Movie recording (actual battery life for recording)<sup>3</sup></b>	Approx. 1 h 10 min when using EN-EL20a

### Tripod socket

<b>Tripod socket</b>	0.635 cm (1/4 in., ISO 1222)
----------------------	------------------------------

### Dimensions (W × H × D)

<b>Dimensions (W × H × D)</b>	Approx. 146.3 × 118.8 × 181.3 mm (5.8 × 4.7 × 7.2 in.) (excluding projections)
-----------------------------------	---

### Weight

<b>Weight</b>	Approx. 1410 g (3 lb 1.8 oz) (including battery and memory card)
---------------	---

## Operating environment

<b>Temperature</b>	0°C–40°C (32°F–104°F)
<b>Humidity</b>	85% or less (no condensation)

- All measurements are performed in conformity with Camera and Imaging Products Association (CIPA) standards or guidelines.
- 1 See “Memory cards that can be used” (□49) for more information about memory cards.
  - 2 Battery life does not reflect the use of SnapBridge and may vary with the conditions of use, including temperature, the interval between shots, and the length of time that menus and images are displayed.
  - 3 Individual movie files cannot exceed 29 minutes in length, even when there is sufficient free space on the memory card for longer recording. The maximum size of a single movie file is 4 GB. If a file exceeds 4 GB even when you record for less than 29 minutes, it is split into multiple files and cannot be played back continuously. Recording may end before the maximum recording time is reached if the camera temperature becomes elevated.

## ■ EN-EL20a Rechargeable Li-ion Battery

<b>Type</b>	Rechargeable lithium-ion battery
<b>Rated capacity</b>	DC 7.2 V, 1110 mAh
<b>Operating temperature</b>	0°C–40°C (32°F–104°F)
<b>Dimensions (W × H × D)</b>	Approx. 30.7 × 50.0 × 14.0 mm (1.2 × 2.0 × 0.6 in.)
<b>Weight</b>	Approx. 42 g (1.5 oz)

The symbols on this product represent the following:

~ AC, = DC, □ Class II equipment (The construction of the product is double-insulated.)

- Nikon will not be held liable for any errors this document may contain.
- The appearance of this product and its specifications are subject to change without notice.
- The sample images displayed on the camera and the images and illustrations in this document are for illustrative purposes only.

## Trademarks and licenses

- Windows is either a registered trademark or a trademark of Microsoft Corporation in the United States and/or other countries.
- The *Bluetooth*<sup>®</sup> word mark and logo are registered trademarks owned by Bluetooth SIG, Inc., and any use of such marks by Nikon is under license.
- Apple<sup>®</sup>, App Store<sup>®</sup>, the Apple logos, iPhone<sup>®</sup>, iPad<sup>®</sup>, Mac, and macOS are trademarks of Apple Inc. registered in the U.S. and/or other countries.
- Android, Google Play and the Google Play logo are trademarks of Google LLC. The Android robot is reproduced or modified from work created and shared by Google and used according to terms described in the Creative Commons 3.0 Attribution License.
- IOS is a trademark or registered trademark of Cisco Systems, Inc., in the United States and/or other countries and is used under license.
- The SD, SDHC, and SDXC logos are trademarks of SD-3C, LLC.
- HDMI, HDMI logo and High-Definition Multimedia Interface are trademarks or registered trademarks of HDMI Licensing, LLC.

### **HDMI**

- Wi-Fi and the Wi-Fi logo are trademarks or registered trademarks of the Wi-Fi Alliance.
- All other trade names mentioned in this document or the other documentation provided with your Nikon product are the trademarks or registered trademarks of their respective holders.
- Use of the Made for Apple badge means that an accessory has been designed to connect specifically to the Apple products identified in the badge, and has been certified by the developer to meet Apple performance standards. Apple is not responsible for the operation of this device or its compliance with safety and regulatory standards.

Please note that the use of this accessory with an Apple product may affect wireless performance.

## ■ ■ FreeType License (FreeType2)

Portions of this software are copyright © 2012 The FreeType Project (<https://www.freetype.org>). All rights reserved.

## ■ ■ MIT License (HarfBuzz)

Portions of this software are copyright © 2016 The HarfBuzz Project (<https://www.freedesktop.org/wiki/Software/HarfBuzz>). All rights reserved.

## ■ ■ AVC Patent Portfolio License

This product is licensed under the AVC Patent Portfolio License for the personal and non-commercial use of a consumer to (i) encode video in compliance with the AVC standard (“AVC video”) and/or (ii) decode AVC video that was encoded by a consumer engaged in a personal and non-commercial activity and/or was obtained from a video provider licensed to provide AVC video. No license is granted or shall be implied for any other use. Additional information may be obtained from MPEG LA, L.L.C. See <http://www.mpegla.com>.

# Index

## A

---

AC adapter .....	16, 51, 317
Accessories .....	317
Active D-Lighting .....	240
AE-L/AF-L button .....	27, 28, 139, 287
AE/AF lock button .....	287
AF area mode .....	149, 232
AF assist .....	284
AF-assist illuminator .....	25
Airplane mode .....	270
Aperture-priority auto mode .....	74, 78
App .....	270
Apply selection button .....	27, 30
Assign side zoom control .....	285
Auto flash .....	123
Auto mode .....	74, 76
Auto off .....	64, 289
Auto with red-eye reduction .....	124, 125
Autofocus .....	132, 133, 137
Autofocus mode .....	237, 251

## B

---

Backlighting .....	94, 108
Battery .....	16, 48, 51, 359, 374
Battery level .....	59
Battery-chamber/memory card slot cover .....	27, 48
Beach .....	94, 102
Bird-watching mode .....	74, 94, 96
Bluetooth .....	272, 303

Brightness .....	277
Built-in flash .....	25, 122
Bulb setting (long time-exposure) .....	85
Button sound .....	288

## C

---

Calendar display .....	166
Charge by Computer .....	292
Charge lamp .....	51
Charging .....	51
Charging AC adapter .....	317
Choose connection .....	270
Choose key picture .....	269
Clean HDMI output .....	291, 309
Cleaning .....	363
Clock .....	55, 274
Close-up .....	94, 105
Color temperature .....	221
Command dial .....	31, 77
Computer .....	312
Conformity marking .....	299
Connect to smart device .....	270
Connection to remote .....	270
Connector cover .....	26, 51
Continuous .....	149, 224
Contrast .....	216
Control ring .....	31, 286
Control ring options .....	286
COOLPIX Custom Picture Control .....	217
COOLPIX Picture Control .....	149, 213

Copyright information .....	295
Creative mode .....	74, 91
Crop .....	164
Custom Picture Control .....	217

## D

---

D-Lighting .....	258
Date and time .....	55, 274
Date format .....	56, 274
Date stamp .....	281
Daylight saving time .....	56, 274
Delete .....	70, 170
Delete button .....	27, 32, 70, 170
Digital zoom .....	152, 285
Diopter adjustment control .....	26, 66
Display button .....	27, 32
Dusk/dawn .....	94, 103
Dynamic Fine Zoom .....	153

## E

---

Easy panorama .....	94, 109
Editing movies .....	194
Editing still images .....	173
Electronic VR .....	252
EN-EL20a .....	374
Erase .....	70, 170
EVF auto toggle .....	281
EVF options .....	277
Exposure bracketing .....	231
Exposure compensation .....	120, 144
Exposure mode .....	183
Extension .....	365

External mic sensitivity .....	254
Extracting still images .....	195
Eye sensor .....	27, 66
Eyelet for strap .....	25

## F

---

F-number .....	77
Face detection .....	136
Face priority .....	233
Fast motion movies .....	248, 250
File name .....	365
Fill flash .....	124
Filter effects .....	216, 260
Fireworks show .....	94, 107
Firmware version .....	300
Flash exp. comp. .....	238
Flash mode .....	120, 122
Flash pop-up control .....	25, 64, 122
Flash-ready indicator .....	123
Fn button setting .....	149
Focal length .....	243, 245
Focal length selection .....	96, 97
Focus .....	61, 177, 232, 237, 251
Focus area .....	36, 61, 113, 232
Focus indicator .....	33
Focus lock .....	138
Focus mode .....	120, 132
Focus-mode selector .....	28
Food .....	94, 106
Format card .....	49, 289
Format memory cards .....	49, 289
Formatting .....	49, 289

Frame rate .....	254
Full-frame playback .....	38, 68, 162, 166
Full-time AF .....	237, 251
Function button .....	25, 32, 149
Functions that cannot be used simultaneously .....	156

## H

---

HDMI .....	290
HDMI cable .....	309
HDMI micro connector .....	26, 309
HDR .....	108
High-speed continuous .....	225
Histogram .....	40, 145, 278
HS movie .....	248, 250

## I

---

Identifier .....	365
Image comment .....	294
Image quality .....	149, 209
Image review .....	277
Image sharpening .....	215
Image size .....	149, 212
Infinity .....	133
Inputting characters .....	273
Interval timer shooting .....	225, 228
ISO sensitivity .....	149, 229

## L

---

Landscape .....	94, 99
Language .....	289
Lens .....	25

Lens cap .....	47
Lens hood .....	47
Li-ion rechargeable battery .....	374
Location data .....	296
Long exposure NR .....	239

## M

---

M exposure preview .....	245
Macro close-up .....	133
Manual focus .....	140
Manual mode .....	74, 78
Mark for upload .....	256
Memory capacity .....	58, 175
Memory card .....	48, 49, 361
Memory card slot .....	48
Menu button .....	27, 31, 197
Metering .....	149, 223
Microphone (stereo) .....	25
Minimum shutter speed .....	230
Mode dial .....	25, 28, 58, 74
Monitor .....	27, 33, 54, 358, 363
Monitor button .....	27, 32, 66
Monitor options .....	277
Monitor settings .....	277
Moon mode .....	74, 94, 97
Movie manual mode .....	74, 183
Movie manual mode menu .....	203, 246
Movie menu .....	204, 247
Movie options .....	247
Movie playback .....	68, 175
Movie recording .....	65, 175

Movie recording time remaining .....	175, 178
Movie-record button .....	27, 29, 65, 175
Multi selector .....	27, 30, 120
Multiple exp. Lighten .....	94, 116
Multiple exposure .....	241

## **N**

---

Network menu .....	206, 270
Night landscape .....	94, 103
Night portrait .....	94, 101
Noise reduction filter .....	239, 239
Number of exposures remaining .....	59, 211
NX Studio .....	312

## **P**

---

Pairing the remote control .....	329
Party/indoor .....	94, 102
Peaking .....	298
Pet portrait .....	94, 113
Pet portrait auto release .....	113
Picture Control .....	149, 213
Playback .....	68, 175
Playback button .....	27, 32, 68
Playback menu .....	205, 256
Playback mode .....	68
Playback zoom .....	69, 162
Portrait .....	94, 99
Power .....	55
Power connector .....	320
Power connector cover .....	27

Power switch .....	25, 55
Power-on lamp .....	25, 44
Pre-shooting cache .....	225, 227
Preset manual .....	221
Pressing halfway .....	29, 61, 134
Print .....	174
Printer .....	174
Programmed auto mode .....	74, 77
Protect .....	264

## **Q**

---

Quick adjust .....	215
Quick retouch .....	257

## **R**

---

Rear-curtain sync .....	124
Rechargeable battery .....	51
Red-eye reduction .....	124, 125
Red-eye reduction lamp .....	25, 125
Remote control .....	325
Reset all .....	299
Reset file numbering .....	297
Reset user settings .....	88
Restore default settings .....	272
Rotary multi selector .....	27, 30, 120
Rotate image .....	266

## **S**

---

Saturation .....	216
Save user settings .....	87
Scene mode .....	74, 94
Screen indicators .....	33

SD memory card .....	48, 49, 361	Speaker .....	27
Selective color .....	94, 115	Sports .....	94, 100
Self-timer .....	120, 127	Standard flash .....	124
Self-timer lamp .....	25, 127, 131	Startup zoom position .....	245
Self-timer: after release .....	282	Strap .....	46
Send while shooting .....	271	Subject tracking .....	234, 236
Sequence .....	168	Sunset .....	94, 102
Sequence display options .....	269	Superlapse movie .....	94, 190
Setup menu .....	207, 274		
Shooting .....	58, 74, 175	<b>T</b>	
Shooting information .....	33	Target finding AF .....	134, 235
Shooting menu .....	201, 209, 213	Telephoto .....	152
Shooting mode .....	74	Thumbnail playback .....	69, 166
Shutter sound .....	288	Time difference .....	274
Shutter speed .....	77	Time setting (long time-exposure) .....	85
Shutter-priority auto mode .....	74, 78	Time zone .....	55, 275
Shutter-release button .....	25, 29, 61, 134	Time zone and date .....	55, 274
Side zoom control .....	26, 29, 152	Time-lapse movie .....	94, 187
Single .....	224	Toggle Av/Tv selection .....	297
Single AF .....	237, 251	Tone level .....	40
Skin softening .....	137, 259	Tone level information .....	39, 43
Slide show .....	263	Toning .....	217
Slot empty release lock .....	276	Tripod socket .....	27
Slow motion movies .....	248, 250	TV .....	309
Slow sync .....	124		
Small picture .....	268	<b>U</b>	
Smile timer .....	120, 130	USB cable .....	51, 312
Snap-back zoom .....	286	USB connector .....	26, 51, 312
Snap-back zoom button .....	26, 29, 154	User settings mode .....	74, 87
SnapBridge app .....	270, 301		
Snow .....	94, 102	<b>V</b>	
Soft .....	94, 115	Vibration reduction .....	149, 283
Sound settings .....	288		

View/hide framing grid .....	37, 278
Viewfinder .....	27, 33, 66, 363
Virtual horizon .....	37, 278, 280
Volume .....	192

## **W**

---

White balance .....	149, 219
Wi-Fi .....	271, 307
Wide-angle .....	152
Wind noise reduction .....	252

## **Z**

---

Zoom .....	152
Zoom control .....	25, 28, 152
Zoom memory .....	243
Zoom microphone .....	253

No reproduction in any form of this document, in whole or in part (except for brief quotation in critical articles or reviews), may be made without written authorization from NIKON CORPORATION.

**NIKON CORPORATION**

---

© 2025 Nikon Corporation

CT5B01(11)  
*6MQ06111-01*