

LITEMONS

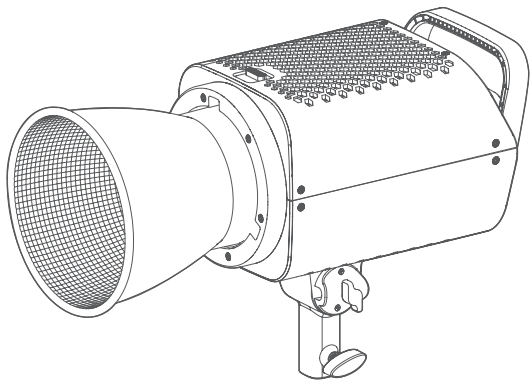

LA150R LA200R LA300R

LITEMONS Full-color LED Light
Instruction Manual

Safety Instructions and Attentions

First of all, as the most basic principle: This product is a professional lighting set equipment and should be used by professional lighting engineers or under the guidance of professionals. Basic safety attentions must always be followed during use, as follows:

1. Before use, please read and understand these instructions and attentions.
2. Professional lighting is prohibited for children. When children are near, parents or accompanying persons must supervise closely to prevent children from personal injury due to collision with lamps or private use of lamps.
3. This lighting product is not ordinary lighting product and cannot be used for general lighting. Anyone who has suffered eye damage or has sensitive eyes should avoid using this product.
4. When the lamp is on, it must be used with care. Do not touch high-temperature parts, such as LED lamp beads, to avoid burns.
5. When the lamp is on, it is forbidden to look directly at the lamp beads under any circumstances. Strong light should be used under the guidance of professional lighting engineers. Avoid prolonged exposure to strong light under any circumstances. If eye discomfort, please turn off the lamp in time, suspend use, and see a doctor immediately.
6. If the lamp bead is damaged or deformed by heat, stop using this equipment, and contact the manufacturer, service agent or qualified maintenance personnel to replace the lamp bead in time to avoid accidents.
7. This product is only suitable for use in -20°C to 40°C operating environment and normal humidity environment.
8. Do not use damaged equipment or accessories, and wait for professional maintenance personnel to check and repair to confirm being normal before use.
9. During using, if the casing of this product is broken due to being dropped, squeezed or subjected to strong impact, please do not use it, so as to avoid electric shock injury due to contact with internal electronic components.
10. If an extension cord is required, please use an extension cord with a current rating greater than or equal to that of the equipment. If an extension cord is rated less than the equipment, overheating may result.
11. Some products have long power cords, please place the power cords properly and keep them in a safe place. Avoid contacting the power cord with overheating surfaces, avoid improper placement that could cause pulling damage, or trip on-site personnel. Please use the certified power cord from the original manufacturer. If the product is damaged by using a non-certified power cord, it will not be repaired by our factory.

12. Be sure to unplug equipment from the power outlet before cleaning and repairing. When not in use, do not pull the power cord to unplug the equipment. For normal power-off, please hold both ends of the plug of the equipment with your hands and pull the plug out of power outlet. This equipment needs to be connected to a grounded outlet.
13. This equipment is not waterproof, please keep it dry and do not immerse it in water or other liquids. The equipment should be installed in a dry and ventilated place, and avoid using it in rainy, humid, dusty or overheated environments. Do not place any objects on the lamp or let liquid flow into the lamp to avoid accidents.
14. Do not disassemble the product without permission. If the product fails, it must be checked and repaired by authorized maintenance personnel.
15. Before storing, make sure that the equipment has cooled down completely. For storage, unplug the power cord from the equipment. The equipment should be placed in the carrying case or in a ventilated dry place.
16. Do not place equipment near flammable and volatile solvents such as alcohol and gasoline.
17. Do not use accessories that are not recommended by our factory to avoid fire, electric shock or personal injury.
18. When cleaning, do not wipe it with a damp cloth, please use a dry cloth or a soft cloth to wipe the dirt of the equipment.
19. Please take off the protective cover before using.
20. This product complies with ROHS, CE and FCC certification, please refer to the relevant national standards for use and operation.
21. The safety instructions are formulated according to the strict testing of the factory, and the design and specifications of the equipment are subject to change without prior notice. For latest product information, please check the GODOX website and view latest electronic instruction.
22. One-year warranty period, accessories such as consumable batteries, adapters, power cords, etc. are not covered by this warranty.
23. If it is found that the equipment is repaired without authorization, the one-year warranty period will be cancelled and relevant fees will be charged for maintenance.
24. Machine failures caused by non-standard operation are not covered by the warranty.





Keep these instructions!

Foreword

Thank you for purchasing!

Brand new LITEMONS LED lights LA150R (input 165W), LA200R (input 220W), and LA300R (input 330W) have the following prominent features: CCT/HSI/RGBW/GEL/FX modes, NFC fixture addition function, remote control through built-in Bluetooth, wide CCT range from 1800K to 10000K, adjustable brightness, high-bright light bead, percentage dimming and etc. Full-color RGBW mode allows different light colors to create the appropriate atmosphere as the shooting theme changes. It is specially designed to provide light source for small scene advertising, microfilm shooting, live streaming and other scenes.

Warning

-  Do not look directly at the LED light or illuminate at others' eyes.
-  Do not plug or unplug the power cable or connecting cable when the power is turned on, otherwise personal injuries may occur.
-  Do not cover the heat dissipation vent in working status.
-  Keep out of reach of children.
-  Please make sure to follow the instruction manual and correctly use this professional lighting device.



Do not stare at the operating light source

The light source contained in this luminaire shall only be replaced by the manufacturer or his service agent or a similar qualified person.

Names of Parts

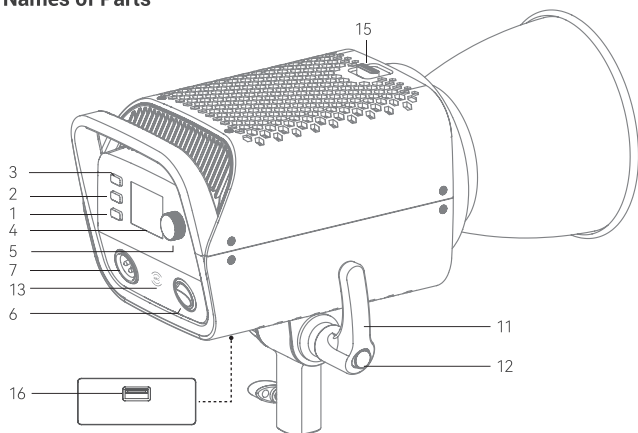

1. Bluetooth Button
2. MENU Button
3. MODE Button
4. Display
5. Select Dial
6. Power Switch
7. DC Input Port
8. Umbrella Hole
9. Umbrella Hole Locking Knob
10. Bracket Locking Knob
11. Adjusting Handle
12. Adjusting Handle Button
13. NFC Sensing Area
14. Bowens Mount
15. Mount Fixing Pusher
16. USB-A Firmware Upgrade Port

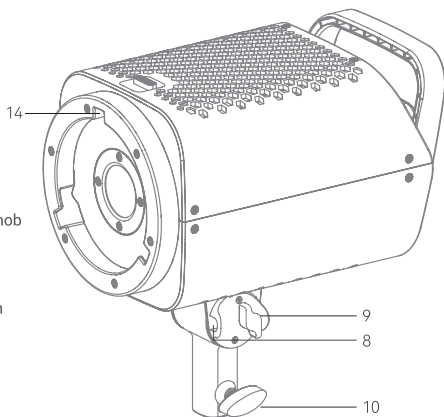

Item List for LA150R / LA200R / LA300R

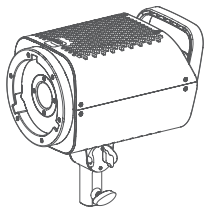

Light Body × 1

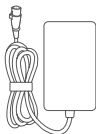

Adapter × 1



AC Power Cord × 1



Wire Rope × 1

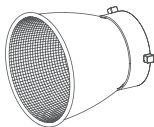

Reflector BR30 × 1



Instruction Manual × 1

Item List for LA150R K1/ LA200R K1/ LA300R K1

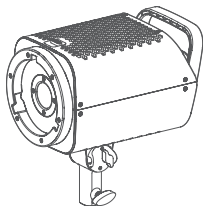

Light Body × 1

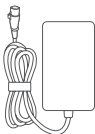

Adapter × 1



AC Power Cord × 1



Wire Rope × 1

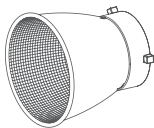

Reflector BR30 × 1

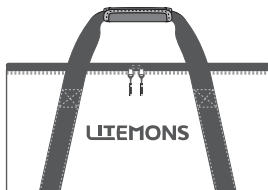

Storage Bag × 1



Instruction Manual × 1

Item List for LA300R 3K

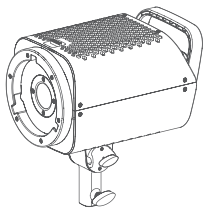

Light Body × 3

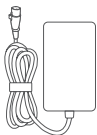

Adapter × 3



Storage Bag × 1



AC Power Cord × 3



Wire Rope × 3

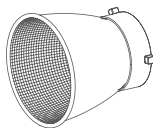

Reflector BR30 × 3



Instruction Manual × 1

Note: Due to continuous updates and upgrades of the products, there may be differences between the actual products and the pictures. Therefore, the pictures are for reference only, products to prevail in kind.

Installing/Detaching Reflector

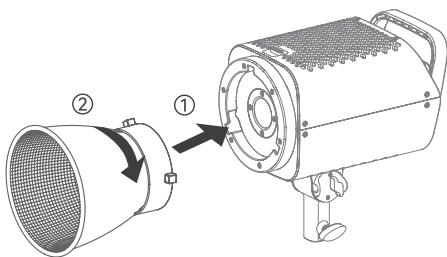

1. Align the reflector with the light head mount and rotate clockwise to install it.

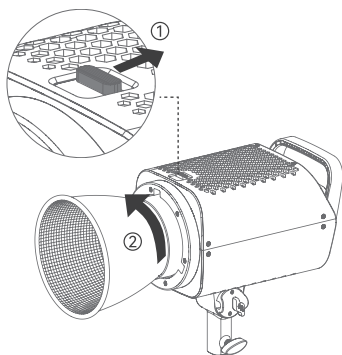

2. Press and hold the mount fixing pusher and rotate counterclockwise to remove the reflector.

Installing the Bracket

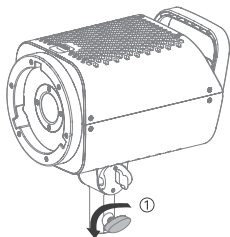

Rotate counterclockwise the bracket locking button to loosen it, install the light body onto the bracket firmly, then rotate clockwise the bracket locking button to tighten it.

Note: the bracket is sold separately.

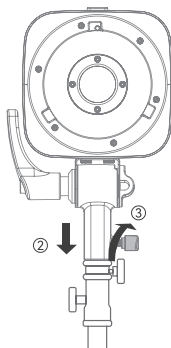

Power Switch

Connect to the power source, toggle the power switch to **|** to turn on the device, toggle it to **○** to turn off the device.

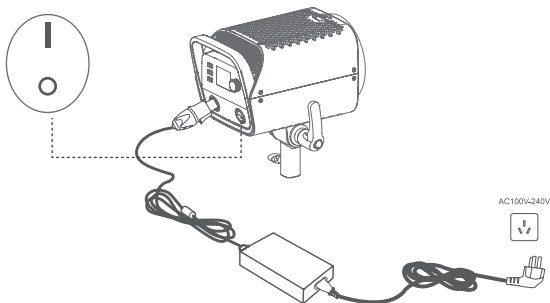

CCT Mode

Press the MODE button to enter mode selection, turn and press the select dial to choose CCT mode. Turn and press the select dial to adjust brightness, CCT and GM values, turn clockwise to increase while turn anticlockwise to decrease.

Brightness: 0% ~ 100%

CCT: 1800K ~ 10000K

GM: -100% ~ +100%

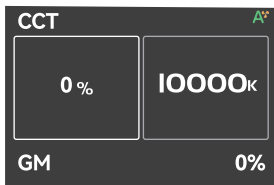

HSI Mode

Press the MODE button to enter mode selection, turn and press the select dial to choose HSI mode. Turn and press the select dial to adjust brightness, HUE and SAT values, turn clockwise to increase while turn anticlockwise to decrease.

Brightness: 0% ~ 100%

HUE: 0 ~ 360

SAT: 0% ~ 100%

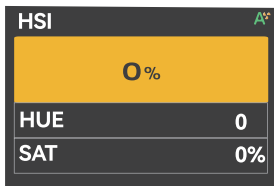

RGBW Mode

Press the MODE button to enter mode selection, turn and press the select dial to choose RGBW mode. Turn and press the select dial to adjust brightness, red, green, blue and white values, turn clockwise to increase while turn anticlockwise to decrease.

Brightness: 0% ~ 100%

Red: 0% ~ 100%

Green: 0% ~ 100%

Blue: 0% ~ 100%

White: 0% ~ 100%

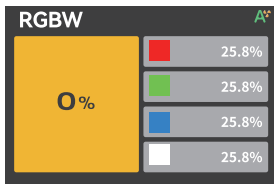

GEL Mode

Press the MODE button to enter mode selection, turn and press the select dial to choose GEL mode. Turn and press the select dial to adjust brightness, GEL type, GEL group type, color, CCT, HUE and SAT values, turn clockwise to increase while turn anticlockwise to decrease.

Brightness: 0% ~ 100%

GEL type: R-GEL/L-GEL

GEL Group Type (R-GEL)
COR. / CAL. / SPC. / CINE.

GEL Group Type (L-GEL)
COR. / COLOR. / 600 / COS. / 700

CCT: 3200K or 5600K

HUE: -10 ~ 10

SAT: -20% ~ 20%

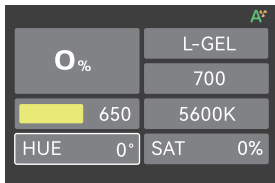

FX Mode

Press the MODE button to enter mode selection, turn and press the select dial to choose FX mode. Turn and press the select dial to choose among flash, lightning, cloudy, broken bulb, TV, candle, fire, firework, explosion, welding, police car, SOS, RGB cycle and party. Then turn and press the select dial clockwise to increase while turn anticlockwise to decrease their respective parameters.

1. Flash

This effect simulates a camera flash or flash bulb and is often used to create a vivid, lively atmosphere.

Brightness: 0% -100% (in 1% increment)

Switch: Turn on/off the effect

Trigger: A (Auto) / M (Manual)

Color: CCT/HSI

CCT/HUE: 1800K-10000K/0-360°

Speed: 1-100

Mode: Camera Flash/Flash Bulb

2. Lightning

This effect simulates the natural thunder and lightning and is often used to create a tense, terrifying or mysterious atmosphere.

Brightness: 0% -100% (in 1% increment)

Switch: Turn on/off the effect

Trigger: A (Auto) / M (Manual)

CCT: 1800K-10000K

Times: Random/1-10

Frequency: Random /2-20

3. Cloudy

This effect simulates the effect of cloud occlusion and is often used to create a gloomy, oppressive or sad atmosphere.

Brightness: 0% -100% (in 1% increment)

Switch: Turn on/off the effect

Ratio: 30% -90%

Speed: Random/1-100

4. Broken Bulb

This effect simulates the effect of a broken bulb and is often used to create a dim atmosphere.

Brightness: 0% -100% (in 1% increment)

Switch: Turn on/off the effect

Color: CCT/HSI

CCT/HUE: 1800K-10000K/0-360°

Speed: 1-100

5. TV

This effect simulates the effect of light from a television or screen and is often used to create a cold, mechanical or digital atmosphere.

Brightness: 0% -100% (in 1% increment)

Switch: Turn on/off the effect

Color: CCT/HSI

Speed: 1-100

6. Candle

This effect simulates the effect of light from a candle and is often used to create a soft, warm, shimmering atmosphere.

Brightness: 0% -100% (in 1% increment)

Switch: Turn on/off the effect

Speed: 1-100

7. Fire

This effect simulates the effect of light from flame and is often used to create a bright, warm, shimmering atmosphere.

Brightness: 0% -100% (in 1% increment)

Switch: Turn on/off the effect

Speed: 1-100

8. Firework

This effect simulates the effect of light from fireworks and is often used to create a gorgeous, colorful, romantic atmosphere.

Brightness: 0% -100% (in 1% increment)

Switch: Turn on/off the effect

Embers: 1-100

Speed: 1-100

9. Explosion

This effect simulates the effect of light from explosion and is often used to create a bright, fierce, shimmering atmosphere.

Brightness: 0% -100% (in 1% increment)

Switch: Turn on/off the effect

Trigger: A (Auto) / M (Manual)

Color: CCT/HSI

CCT/HUE: 1800K-10000K/0-360°

Embers: 1-100

Speed: 1-100

10. Welding

This effect simulates the effect of light from welding and is often used to create a hot, mechanical atmosphere.

Brightness: 0% -100% (in 1% increment)

Switch: Turn on/off the effect

Color: CCT/HSI

CCT/HUE: 1800K-10000K/0-360°

Speed: 1-100

11. Police Car

This effect simulates the effect of light from police car and is often used to create a tension, chasing atmosphere.

Brightness: 0% -100% (in 1% increment)

Switch: Turn on/off the effect

Color: Red+Blue/Red/Blue/Blue+White/Blue+Yellow/Yellow/Red+White+Blue/ Red +Yellow+Blue

Mode: 1-5

12. SOS SOS

This effect simulates the flashing effect of an SOS signal and is often used to create a dangerous, distress or emergency atmosphere.

Brightness: 0% -100% (in 1% increment)

Switch: Turn on/off the effect

Color: CCT/HSI

CCT/HUE: 1800K-10000K/0-360°

13. RGB Cycle

This effect simulates the effect cycle and change of colorful lights and is often used to create a fantasy, sci-fi atmosphere.

Brightness: 0% -100% (in 1% increment)

Switch: Turn on/off the effect

SAT: 0%-100%

Speed: 1-100

14. Party

This effect simulates the effect of colorful lights, flashes and laser, and is often used to create a carnival, fun, high energetic atmosphere.

Brightness: 0% -100% (in 1% increment)

Switch: Turn on/off the effect

SAT: 0%-100%

Speed: 1-100

Note: Please turn the select dial to adjust the parameters, then press and turn it to the next parameter. Select manual, the effect can be triggered once by pressing the select dial once. After a certain effect is set, press MODE button can return to the 14 effects interface.

MENU Settings

Press the MENU button to enter menu interface, turn and press the select dial to enter the following setting options.

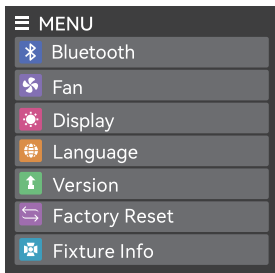

1. Bluetooth

Turn and press the select dial to enter Bluetooth, turn it to select between Bluetooth switch (on/off) and reset, while the Bluetooth MAC code is on the right corner for convenient check, then press MENU button to return to the menu interface.

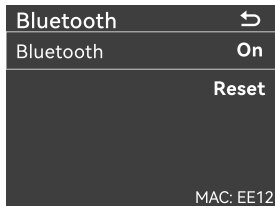

Quick Bluetooth Reset: Press and hold the Bluetooth button to quickly reset the Bluetooth, the "Resetting" progress bar is full means Bluetooth is resetting.

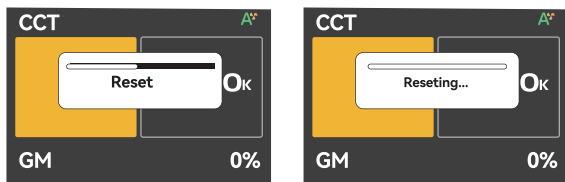

"GODOX Light" App Download

Scan the QR code to download the "Godox Light" smartphone app (can be used in Android and Apple).

Note:

1. The app can be used directly on the firstly installed device (smartphone or iPad). When change to other mobile device (smartphone or iPad), the light shall be reset before the normal connection of app.
2. The app needs to be version V3.0 or above.



2. Fan

Turn and press the select dial to enter fan, turn it to select among off, auto, medium and high, then press MENU button to return to the menu interface.

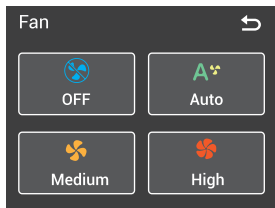

3. Display

Turn and press the select dial to enter display, turn it to adjust screen brightness from 10% to 100% (turn clockwise to increase while turn anticlockwise to decrease), then press MENU button to return to the menu interface.

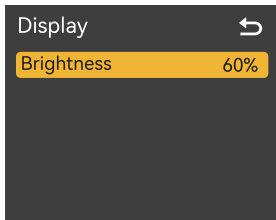

4. Language

Turn and press the select dial to enter language, turn it to select between simplified Chinese and English, then press MENU button to return to the menu interface.



5. Version

Turn and press the select dial to enter version, on which you can check upgrade steps and firmware version on the right corner, then press MENU button to return to the menu interface.



6. Factory Reset

Turn and press the select dial to enter factory reset, turn it to select yes or no. The device will automatically reset and reboot if you choose yes, then simplified Chinese and English options show on the display for your choice, after which the brightness will turn to 100% and go to CCT mode automatically.



7. Fixture Info

Turn and press the select dial to enter fixture info, on which you can check model, firmware version and light head temperature, then press MENU button to return to the menu interface.

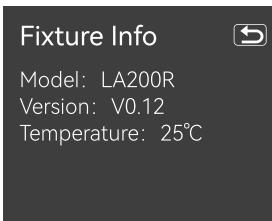
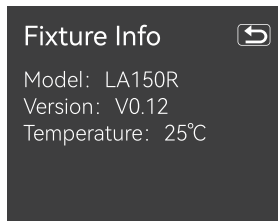

NFC Addition

Use the NFC function of smartphone and NFC chip of the light fixture to connect them, then add the light fixture to **【Godox Light】** app.

1. Preconditions: light fixture supports NFC addition, **【Godox Light】** app is V3.2.4 or above, Bluetooth and NFC functions of smartphone are turned on.
2. Operation Instructions: subject to the fulfillment of preconditions, turn on the **【Godox Light】** app and enter the corresponding scene, click **【+】** to select **【NFC Addition】** function, bring the NFC sensing area of smartphone near the sensing area of light fixture to scan to add in **【NFC Addition】** interface, bulk addition is also supported.

Note: Android systems can complete the addition by directly closing the sensing area, while iOS system need to click the  icon on the right top and wait for the pop-up window then add.

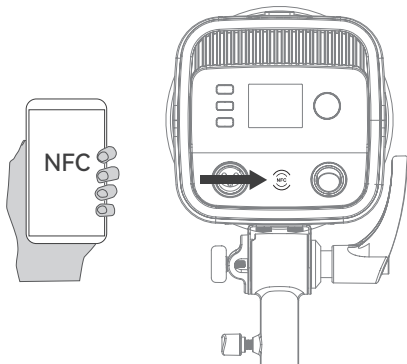

Maintenance

- This product, except consumables, is supported with a one-year warranty.
- Unauthorized service will void the warranty.
- Maintenance of the light must be performed by our authorized maintenance department which can provide original accessories.
- If the product had failures or was wetted, do not use it until it is repaired by professionals.
- Shut down the device immediately should abnormal operation be detected.
- Changes made to the specifications or designs may not be reflected in this manual.

Illuminance Data

LA150R

CCT	Condition	Unit	1m	3m	5m
1800K	Bare Light	lux	≈2438	≈272	≈93
		fc	≈225	≈25	≈9
2800K		lux	≈5270	≈613	≈229
		fc	≈489	≈57	≈21
3200K		lux	≈5490	≈637	≈239
		fc	≈510	≈59	≈22
4300K		lux	≈5370	≈619	≈233
		fc	≈498	≈58	≈22
5600K		lux	≈5060	≈582	≈217
		fc	≈471	≈54	≈20
6500K		lux	≈4960	≈571	≈213
		fc	≈461	≈53	≈20
8500K		lux	≈4750	≈546	≈204
		fc	≈441	≈51	≈19
10000K		lux	≈4640	≈534	≈200
		fc	≈431	≈50	≈19
Red	lux	≈1190	≈124	≈46	
	fc	≈110	≈12	≈4	
Green	lux	≈1849	≈209	≈79	
	fc	≈172	≈19	≈7	
Blue	lux	≈589	≈68	≈26	
	fc	≈55	≈6	≈2	

CCT	Condition	Unit	1m	3m	5m
1800K	With Reflector BR30	lux	≈27968	≈2502	≈883
		fc	≈2602	≈233	≈82
2800K		lux	≈54400	≈4960	≈1720
		fc	≈5050	≈461	≈160
3200K		lux	≈57100	≈5070	≈1770
		fc	≈5300	≈471	≈164
4300K		lux	≈55500	≈4940	≈1720
		fc	≈5150	≈459	≈160
5600K		lux	≈52900	≈4660	≈1620
		fc	≈4910	≈433	≈151
6500K		lux	≈51400	≈4560	≈1580
		fc	≈4780	≈424	≈147
8500K		lux	≈49300	≈4370	≈1510
		fc	≈4580	≈406	≈141
10000K		lux	≈48200	≈4290	≈1480
		fc	≈4480	≈398	≈138
Red	lux	≈12880	≈1168	≈411	
	fc	≈1196	≈109	≈38	
Green	lux	≈20332	≈1840	≈636	
	fc	≈1895	≈171	≈59	
Blue	lux	≈6010	≈554	≈191	
	fc	≈559	≈52	≈18	

LA200R

CCT	Condition	Unit	1m	3m	5m
1800K	Bare Light	lux	≈2646	≈298	≈110
		fc	≈246	≈28	≈10
2800K		lux	≈6430	≈731	≈274
		fc	≈603	≈68	≈25
3200K		lux	≈6620	≈758	≈282
		fc	≈615	≈71	≈26
4300K		lux	≈6520	≈748	≈279
		fc	≈606	≈70	≈26
5600K		lux	≈6210	≈711	≈265
		fc	≈577	≈66	≈25
6500K		lux	≈6060	≈697	≈259
		fc	≈563	≈65	≈24
8500K		lux	≈5850	≈673	≈250
		fc	≈543	≈63	≈23
10000K	lux	≈5720	≈661	≈246	
	fc	≈532	≈61	≈23	
Red	lux	≈1284	≈143	≈54	
	fc	≈200	≈13	≈5	
Green	lux	≈1999	≈227	≈86	
	fc	≈186	≈21	≈8	
Blue	lux	≈623	≈70	≈26	
	fc	≈58	≈6	≈2	

CCT	Condition	Unit	1m	3m	5m
1800K	With Reflector BR30	lux	≈31066	≈2822	≈980
		fc	≈2891	≈263	≈91
2800K		lux	≈65900	≈5930	≈2050
		fc	≈6120	≈552	≈190
3200K		lux	≈68000	≈6070	≈2110
		fc	≈6320	≈564	≈196
4300K		lux	≈67300	≈5970	≈2070
		fc	≈6250	≈554	≈192
5600K		lux	≈64000	≈5850	≈1980
		fc	≈5950	≈544	≈184
6500K		lux	≈62800	≈5560	≈1930
		fc	≈5830	≈517	≈180
8500K		lux	≈60600	≈5380	≈1880
		fc	≈5630	≈500	≈175
10000K		lux	≈59400	≈5280	≈1830
		fc	≈5520	≈93	≈170
Red		lux	≈14014	≈1303	≈452
		fc	≈1303	≈122	≈42
Green	lux	≈21854	≈1999	≈691	
	fc	≈2029	≈186	≈64	
Blue	lux	≈6290	≈561	≈195	
	fc	≈585	≈52	≈18	

LA300R

CCT	Condition	Unit	1m	3m	5m
1800K	Bare Light	lux	≈3050	≈328	≈123
		fc	≈283	≈31	≈11
2800K		lux	≈9930	≈1120	≈415
		fc	≈922	≈104	≈39
3200K		lux	≈10100	≈1140	≈425
		fc	≈935	≈106	≈40
4300K		lux	≈9750	≈1110	≈414
		fc	≈905	≈103	≈39
5600K		lux	≈9210	≈1030	≈392
		fc	≈856	≈96	≈36
6500K		lux	≈8430	≈964	≈358
		fc	≈783	≈90	≈33
8500K		lux	≈7510	≈859	≈319
		fc	≈698	≈80	≈40
10000K		lux	≈7200	≈822	≈396
		fc	≈669	≈76	≈37
Red		lux	≈1560	≈176	≈66
		fc	≈145	≈16	≈6
Green	lux	≈2100	≈238	≈89	
	fc	≈195	≈22	≈8	
Blue	lux	≈766	≈86	≈32	
	fc	≈71	≈8	≈3	

CCT	Condition	Unit	1m	3m	5m
1800K	With Reflector BR30	lux	≈36600	≈3340	≈1160
		fc	≈3400	≈310	≈107
2800K		lux	≈100000	≈8990	≈3100
		fc	≈9310	≈835	≈288
3200K		lux	≈102000	≈9170	≈3160
		fc	≈9450	≈852	≈294
4300K		lux	≈99800	≈8930	≈3080
		fc	≈9270	≈830	≈286
5600K		lux	≈94700	≈8450	≈2910
		fc	≈8800	≈785	≈271
6500K		lux	≈86300	≈7640	≈2630
		fc	≈8020	≈710	≈245
8500K		lux	≈77100	≈6850	≈2370
		fc	≈7160	≈636	≈220
10000K		lux	≈73900	≈6580	≈2280
		fc	≈6870	≈611	≈211
Red		lux	≈17400	≈1590	≈548
		fc	≈1610	≈147	≈51
Green	lux	≈22800	≈2070	≈716	
	fc	≈2120	≈193	≈67	
Blue	lux	≈7860	≈699	≈238	
	fc	≈730	≈65	≈22	

The above data are average values instead of absolute values, and the above tests are conducted on the condition of 100% brightness.

Technical Data

Model	LA150R	LA200R	LA300R
Input Power	165W	220W	330W
Power Supply	100V-240V ~ 50/60Hz		
CCT	1800K-10000K		
GM Adjust	-100% ~ 100%		
Brightness Range	0%-100%		
CRI	Average \geq 95		
TLCI	Average \geq 94		
Bluetooth Control Distance	Max. 30m		
Working Environment Temperature	-20°C ~ 40°C		
Dimension (without reflector)	\approx 9.09" \times 6.14 " \times 9.37		
Net Weight (without reflector)	\approx 2.5kg		

FCC Statement

This device complies with part 15 of the FCC Rules. Operation is subject to the following two conditions:

- (1) This device may not cause harmful interference, and
- (2) this device must accept any interference received, including interference that may cause undesired operation.

Any Changes or modifications not expressly approved by the party responsible for compliance could void the user's authority to operate the equipment.

Note: This equipment has been tested and found to comply with the limits for a Class B digital device, pursuant to part 15 of the FCC Rules. These limits are designed to provide reasonable protection against harmful interference in a residential installation. This equipment generates uses and can radiate radio frequency energy and, if not installed and used in accordance with the instructions, may cause harmful interference to radio communications. However, there is no guarantee that interference will not occur in a particular installation. If this equipment does cause harmful interference to radio or television reception, which can be determined by turning the equipment off and on, the user is encouraged to try to correct the interference by one or more of the following measures:

- Reorient or relocate the receiving antenna.
- Increase the separation between the equipment and receiver.
- Connect the equipment into an outlet on a circuit different from that to which the receiver is connected.
- Consult the dealer or an experienced radio/TV technician for help.

The device has been evaluated to meet general RF exposure requirement.

The device can be used in portable exposure condition without restriction.

Warning

Operating frequency: 2402MHz – 2480MHz (BT)

Maximum EIRP Power: 9.05dBm(LA150R , LA200R) , 9.49dBm(LA300R)

Declaration of Conformity

GODOX Photo Equipment Co.,Ltd. hereby declares that this equipment are in compliance with the essential requirements and other relevant provisions of Directive 2014/53/EU. In accordance with Article 10(2) and Article 10(10), this product is allowed to be used in all EU member states. For more information of DoC, Please click this web link:

<https://www.godox.com/eu-declaration-of-conformity/>

The device complies with RF specifications when the device used at 0mm from your body.

Warranty

Dear customers, as this warranty card is an important certificate to apply for our maintenance service, please fill in the following form in coordination with the seller and safe-keep it. Thank you!

Product Information	Model	Product Code Number
Customer Information	Name	Contact Number
	Address	
Seller Information	Name	
	Contact Number	
	Address	
	Date of Sale	
Note		

Note: This form shall be sealed by the seller.

Applicable Products

Applicable ProductsThe document applies to the products listed on the Product Maintenance Information (see below for further information). Other products or accessories (e.g. promotional items,giveaways and additional accessories attached,etc.) are not included in this warranty scope.

Warranty Period

The warranty period of products and accessories isimplemented according to the relevant Product Maintenance Information. The warranty period is calculated from the day(purchase date) when the product is bought for the first time,And the purchase date is considered as the date registered onthe warranty card when buying the product.

How to Get the Maintenance Service

If maintenance service is needed, you can directly contact the product distributor or authorized service institutions. You can also contact the Godox after-sale service call and we will offer you service. When applying for maintenance service, you should provide valid warranty card. If you cannot provide valid warranty card, we may offer you maintenance service once confirmed that the product or accessory is involved in the maintenance scope, but that shall not be considered as our obligation.

Inapplicable Cases

The guarantee and service offered by this document are not applicable in the following cases: ① **The product or accessory has expired its warranty period;** ② **Breakage or damage caused by inappropriate usage, maintenance or preservation, such as improper packing, improper usage, improper plugging in/out external equipment, falling off or squeezing by external force, contacting or exposing to the improper temperature, solvent, acid, base, flooding and damp environments, etc;** ③ **Breakage or damage caused by non-authorized institution or staff in the process of installation, maintenance, alternation, addition and detachment;** ④ **The original identifying information of product or accessory is modified, alternated, or removed;** ⑤ **No valid warranty card;** ⑥ **Breakage or damage caused by using illegally authorized, nonstandard or non-public released software;** ⑦ **Breakage or damage caused by force majeure or accident;** ⑧ **Breakage or damage that could not be attributed to the product itself.** Once met these situations above, you should seek solutions from the related responsible parties and Godox assumes no responsibility. The damage caused by parts, accessories and software that beyond the warranty period or scope is not included in our maintenance scope. The normal discoloration, abrasion and consumption are not the breakage within the maintenance scope.

Maintenance and Service Support Information

The warranty period and service types of products are implemented according to the following Product Maintenance Information:

Product Type	Name	Maintenance Period(month)	Warranty Service Type
Parts	Circuit board	12	Customer sends the product to designated site
	Battery	3	Customer sends the product to designated site
	Electrical parts e.g.battery charger, etc.	3	Customer sends the product to designated site
Other Items	Lamp body, lamp cover, locking device, package, etc.	No	Without warranty



Wechat
Official Account

GODOX Photo Equipment Co., Ltd.

Add.: Building 2, Yaochuan Industrial Zone, Tangwei Community, Fuhai Street, Bao'an District, Shenzhen
518103, China Tel: +86-755-29609320(8062) Fax: +86-755-25723423 E-mail: godox@godox.com

www.godox.com

Made in China | 705-LA200R-03

