



23.6" WIDESCREEN LED TV

MODEL NO.: SC-2420VTV



USER MANUAL

Please read this manual carefully before using,
and keep it for future reference.

IMPORTANT INSTRUCTIONS

SAFETY INSTRUCTIONS

WARNING – TO REDUCE THE RISK OF FIRE, ELECTRIC SHOCK, OR SERIOUS PERSONAL INJURY:

- This product shall not be exposed to dripping or splashing and that no objects filled with liquids, such as vases, shall be placed on the apparatus.
- Situate this product away from heat sources such as radiators, heat registers, stoves, or other appliances (including amplifiers) that produce heat.
- Clean the product only as recommended by the manufacturer (see “Maintenance” section for details). Unplug the power cord from the wall outlet before cleaning,
- Unplug the power plug from the wall outlet when left unused for an extended period.
- Prevent objects/liquids from falling or spilled on the product.
- Operate the product only with the supplied power cord. Route power cords so they are not likely to be walked on or pinched by items placed upon or against them, paying particular attention to plugs, convenience receptacles, and the point where they exit from the product.
- Where the MAINS plug or an appliance coupler is used as the disconnect device, the disconnect device shall remain readily operable.
- Do not operate this product under the following conditions.
 - When the power-supply cord or plug is damaged.
 - If liquid has been spilled into or objects have fallen into the product.
 - If the product has been exposed to rain or water.
 - If the product does not operate when used according to the operating instructions.
 - If the product has been dropped or damaged in any way.
- Do not attempt to service the product; take it to the electronics repair shop of your choice for any servicing or repair.
- Do not overload wall outlets, extension cords, or integral convenience receptacles.

- Connect this product to the power outlet which has protective earth connection.

 CAUTION- TO REDUCE THE RISK OR PERSONAL INJURY OR PRODUCT/PROPERTY DAMAGE:

- This product is intended solely for non-commercial, non-industrial, personal use as a television. Do not use this product for any other purpose.
- Do not subject the product to violent shocks, extreme temperatures, or lengthy periods of direct sunlight.
- Keep the product away from magnetic objects, motors, and transformers.
- Do not use outdoors in inclement weather.
- Do not use the TV while driving; this is dangerous and is illegal in some areas.



At full volume, prolonged listening to the portable audio device may damage the user’s hearing.

BATTERY HANDLING AND USAGE:

- Keep batteries away from children and pets. Only adults should handle batteries.
- Never throw batteries into a fire or expose them to fire or other heat sources.
- Follow the battery safety and usage instructions.

ACCESSORIES

User Manual.....	1
Remote Control.....	1
Car Adaptor.....	1

All the pictures in this manual are just for your reference, appearance and display should subject to the final product.

TABLE OF CONTENTS

GETTING STARTED

IMPORTANT INSTRUCTIONS.....	1-2
ACCESSORIES.....	2
FEATURES.....	4
GENERAL PARTS.....	5-6
REMOTE CONTROL.....	7-8
REMOTE CONTROL PREPARATION.....	9
BASIC CONNECTION.....	10-13

OPERATIONS

BASIC OPERATIONS.....	14
LIVE TV.....	15-17
CONNECTION.....	18-22
MULTI-SCREEN.....	22-23
SMART FUNCTIONS.....	24-27
PICTURE AND SOUND.....	28-32
CHANNEL.....	33
ACCESSIBILITY.....	34
SYSTEM AND SUPPORT.....	35-38

FOR REFERENCE

MAINTENANCE.....	39
WALL MOUNTING.....	39
STAND INSTALLATION.....	40
SPECIFICATIONS.....	41
TROUBLESHOOTING.....	42

FEATURES

23.6" LED DISPLAY

This player has a built-in LED display window to provide clear vision and low radiation.

Support Auto Program Scanning Function

Support Digital Broadcasting Reception

Support EPG (Electronic Program Guide) Function

Compatible with USB for Music, Photo and Video Playback (TV Mode)

Support Multi-languages On Screen Display

Support Full Function Remote Control

Compatible with LAN, AV and HDMI Input

Compatible with EARPHONE and OPTICAL Output

With Detachable Stand Holder

With External Antenna Jack

With Built-in Speakers

With Noise Reduction Function

GENERAL PARTS

MAIN UNIT

Front View



Back View

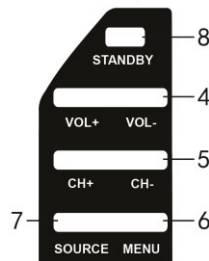
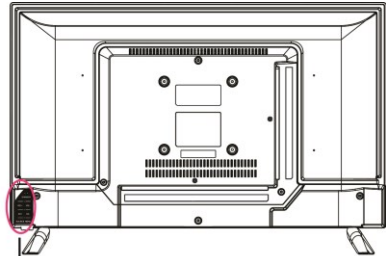

1. LED display screen
2. Remote control sensor / Power indicator - In standby mode the indicator light is red; when switching on the unit the indicator light is blue color.
3. Stand holder
4. VOL +/- button- To increase/decrease the volume level or move left/right.
5. CH +/- button- To select next/previous channel or move up/down.
6. MENU button- To enter menu setting page.
7. SOURCE button- To select the input source.
8. STANDBY button- To turn the TV ON/OFF.

GENERAL PARTS

Back View

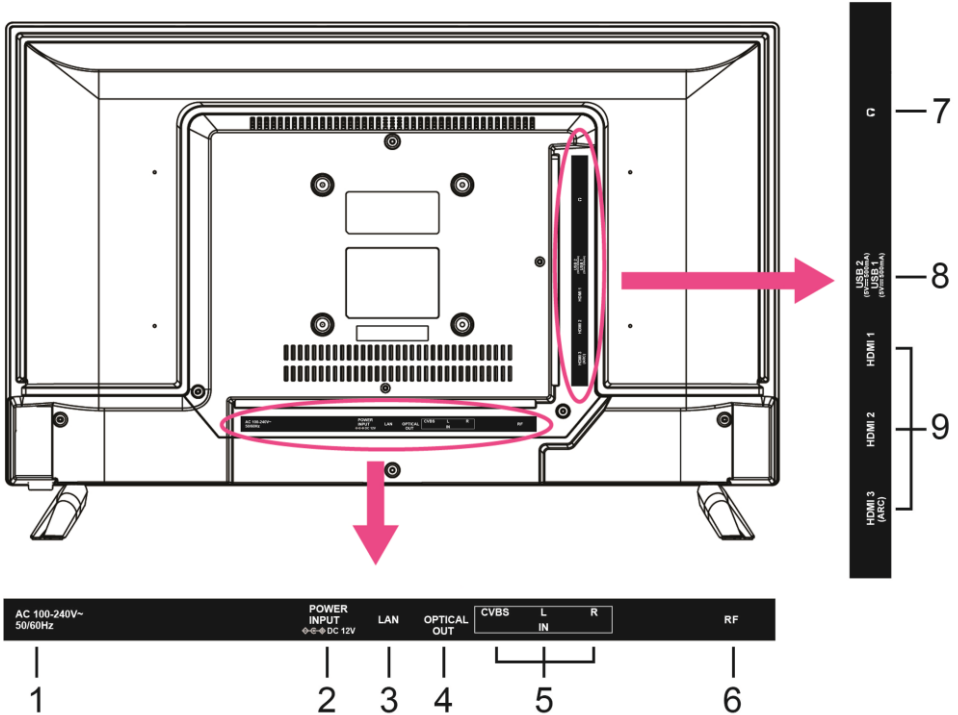

1. Power input
2. Power input (DC)
3. LAN (Local Area Network) input terminal
4. OPTICAL output terminal
5. CVBS and Audio L/R input terminal
6. RF input terminal- To connect the external TV antenna (DVB-T/DVB-T2/DVB-C)
7. EARPHONE output terminal
8. USB 1/2 input terminal
9. HDMI 1/2/3 input terminal (Only HDMI 3 support ARC)

REMOTE CONTROL

1 **STANDBY(POWER)**

Set the unit in standby mode; press it again to switch it on.

2 **INPUT**

Press to select desired input source.

3 **Number buttons (0-9)**

Input the number information, such as channel number and so on.

4 **MTS**

To select desired soundtrack in TV mode.

5 **—**

Switch the digit when watching TV programs.

6 **◀◀**

Move fast backward.



Start/pause playing.



Stop playing.



Move fast forward.

7 **☰ (MENU)**

Call out the main menu or return to previous

8 **4 Color**

Customized in different page.

9 **DIRECTION/OK**

Move up, down, left, right/Confirm.

10 **↶**

Return to the previous interface or menu.

11 **EXIT**

Exit the current interface or menu.



REMOTE CONTROL

- 12**  (**HOME**)
Press to enter home page.
- 13** **VOL +/-**
Increase/decrease the volume level.
- 14** **CH +/-**
Play the next/previous program.
- 15** **MUTE**
Mute the sound.
- 16** **LIVE TV**
TV source.
- 17** **SLEEP**
Set desired sleep time.
- 18** **CC**
CC in LIVE TV.
- 19** **FREE**
Press to enter the free video directly.
- 20** **SPORTS**
Press to enter the sport programme directly.
- 21** **DEEZER**
Press to enter the deezer directly.
- 22** **Content area**
Six buttons for CSP Apps.



Note: The marks and positions of remote control may vary depending on the model.

REMOTE CONTROL PREPARATION

BATTERY INSTALLATION

Install the batteries as the following pictures. Be sure + and – terminals are positioned as indicated in the battery compartment (Fig1).

SERVICE LIFE OF BATTERIES

- The batteries normally last for one year although this depends on how often the remote control is used.
- If the remote control fails to work even when it is operated near the player, replace the batteries.
- Use two size AAA dry batteries.

NOTE:

- Do not drop, step on or otherwise impact the remote control. This may damage the parts or lead to malfunction.
- If the remote control is not going to be used for a long time, remove the batteries.

REMOTE CONTROL OPERATION

Point the remote control from no more than about 6m from the remote control sensor and within about 60° of the front of the player (Fig2).

NOTES:

- The operating distance may vary according to the brightness of the room.
- Do not point bright light at remote control sensor.
- Do not place objects between the remote control and the remote control sensor.
- Do not use this remote control while simultaneously operating the remote control of any other equipments.

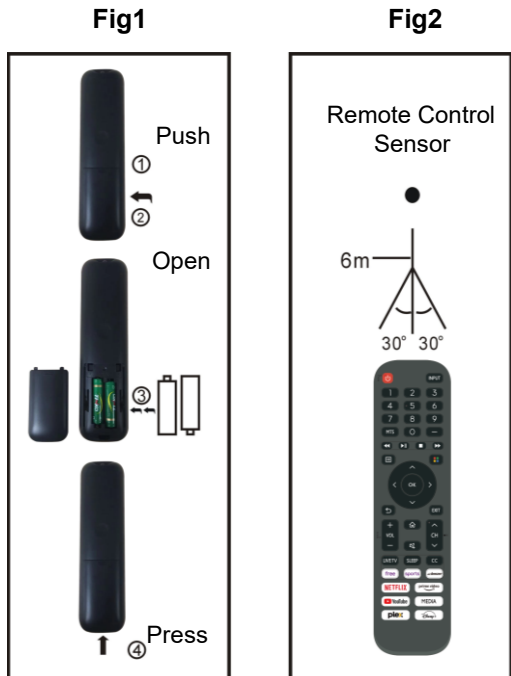

BASIC CONNECTION

- Ensure all the cables are disconnected from the main unit before connecting to AC power source.
- Read through the instructions before connecting other equipments.

CONNECTING TO AC POWER SOURCE

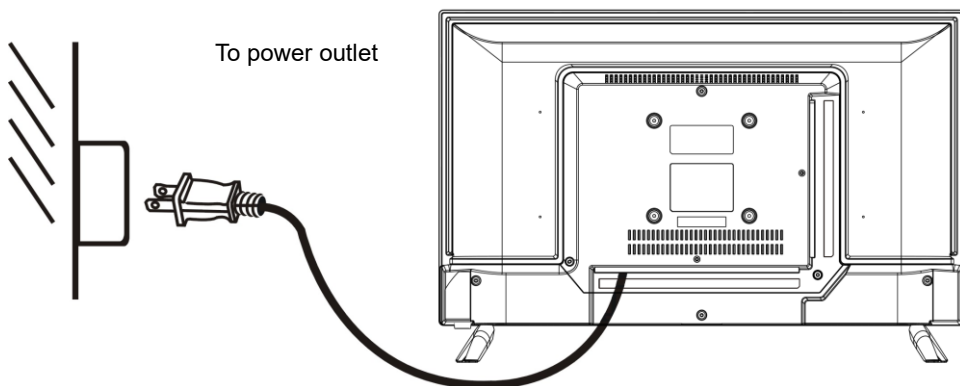

CONNECT EXTERNAL ANTENNA TO UNIT

Install external antenna into antenna jack for best picture.

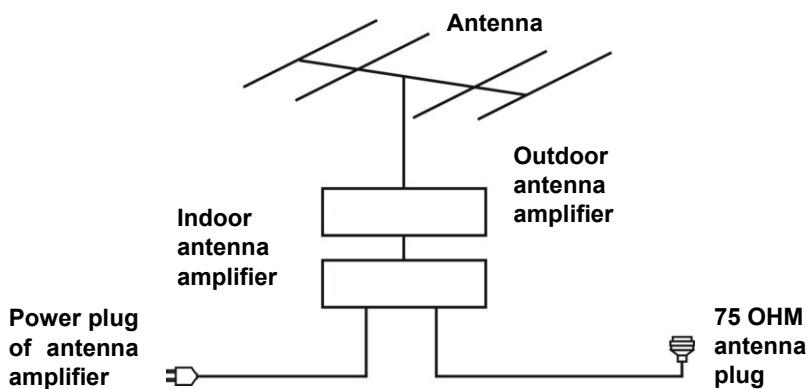

HDMI CONNECTION

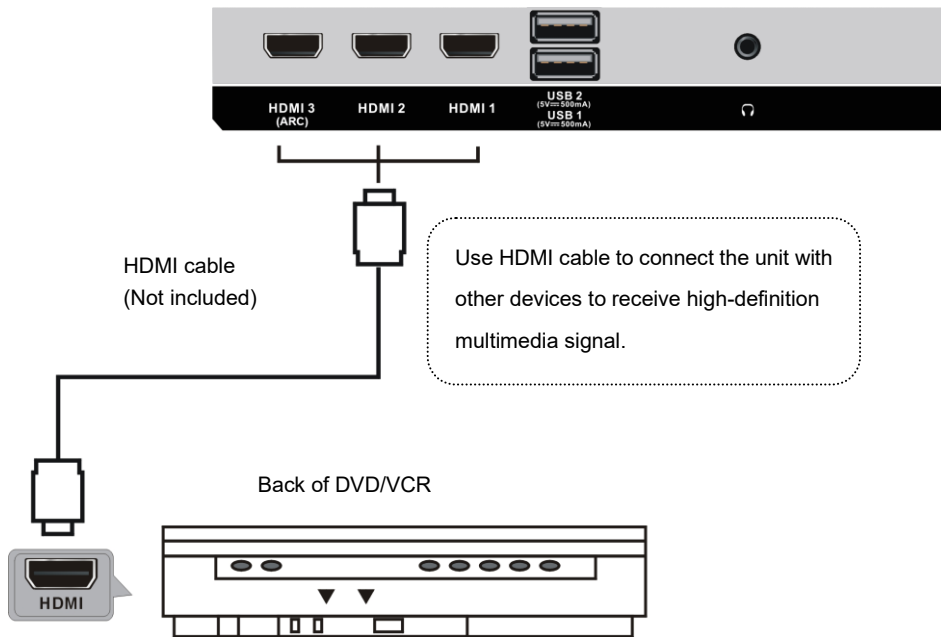

EARPHONE CONNECTION

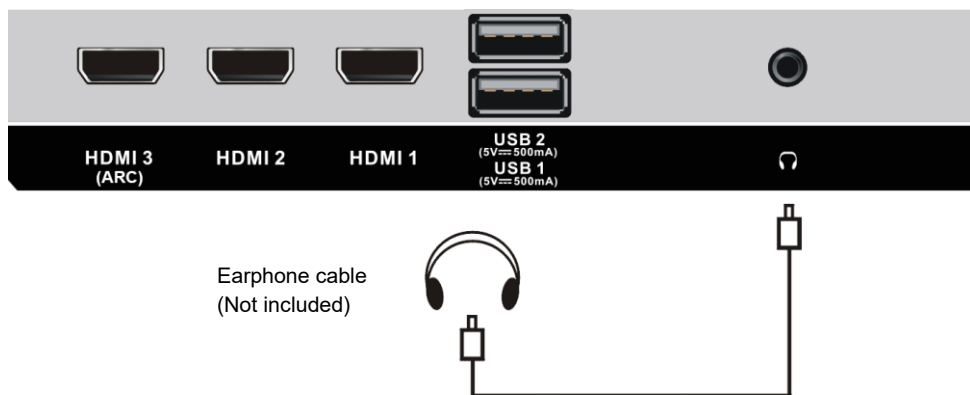

USB CONNECTION

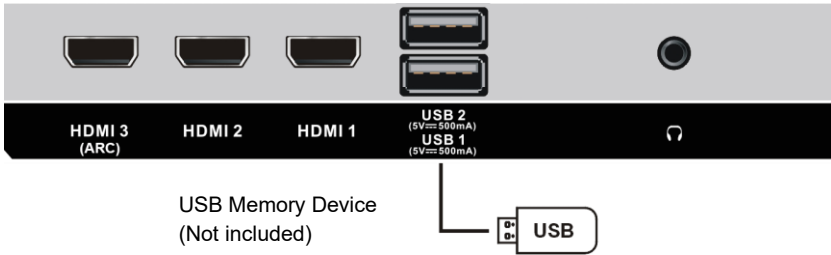

COMPOSITE AV (CVBS) CONNECTION

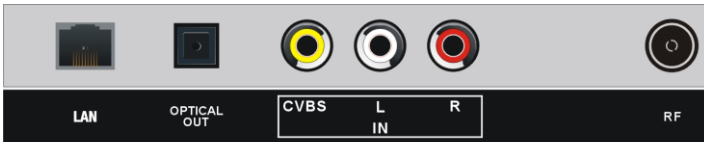

AV cable
(Not included)

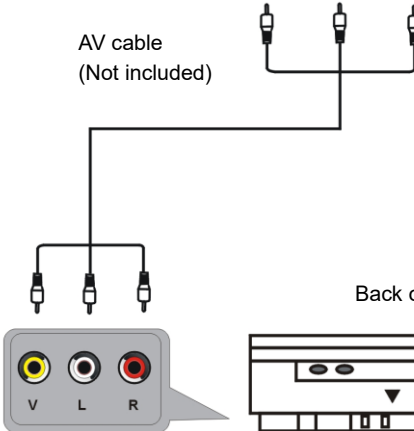

For basic connection, use the composite Audio L/R (white/red) and CVBS (yellow) cable to connect the unit with other devices.

Back of DVD/VCR

OPTICAL CONNECTION

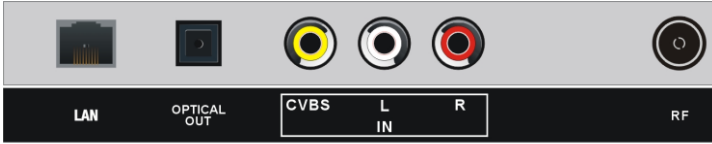

Use OPTICAL cable (not included) to connect the unit with amplifier or other audio decoding devices for digital audio signal output.

LAN (Local Area Network) Connection

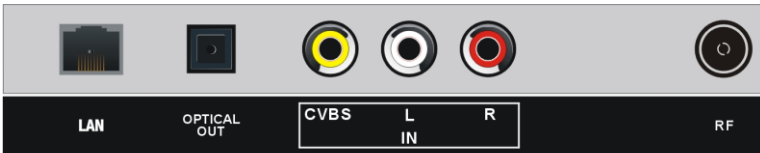

Use a LAN cable (not included) to connect this TV with available network.

MAKE SURE ALL THE EQUIPMENTS AND POWER PLUG ARE CONNECTED PROPERLY AND THE UNIT IS SET IN CORRECT MODE BEFORE OPERATING.

BASIC OPERATIONS

- Press *STANDBY* button on the unit or remote control to power *ON* the unit (indicator will glow blue); press it again to power *OFF* (standby mode) the unit (indicator will glow red).

SELECT DESIRED PROGRAM

1. Press CH+ button to play next channel.
2. Press CH- button to play previous channel.
3. Press number buttons on remote control directly to select desired program.

VOLUME CONTROL

- Press VOL+ or VOL- to adjust the level of current volume.
Available range: 0-100.

MUTE CONTROL

- Press MUTE button to mute the sound, press it again to turn on the sound.

SOURCE SETTING

- Press INPUT button on the remote control to display the sources list.
- Press navigation buttons to select desired input source, and then press OK button to confirm selection.

INFORMATION DISPLAY

- Press UP navigation button on remote control to display information of current program.

MEDIA PLAYBACK

- Insert a USB memory device into USB slot before following operations.
- Press INPUT button on remote control to switch the unit to USB mode.
- Press UP/DOWN/LEFT/RIGHT navigation button to move the cursor.
- Press BACK button to return to previous menu page.

Favorite

Adding channels to your 'Favorites' list

- Press **OK** button to call out the channel list, the channel list appears on the right side of the screen.
- Press **Menu** button and Navigation button to select your favorite channel; Press **OK** button to confirm.
- Press **Left Arrow** and Choose Add to Favorite; press OK button and a heart-shaped icon will appear next to your favorite channel.

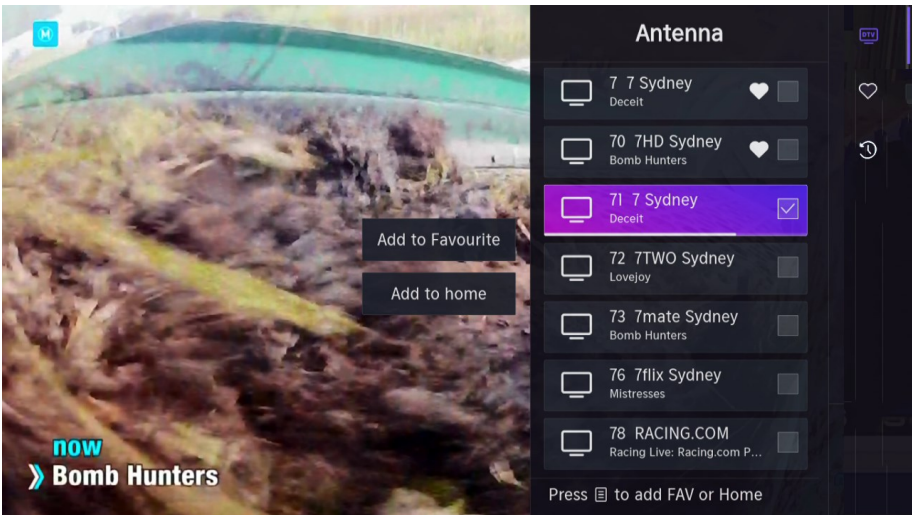

Viewing your 'Favorites' list

- Press **OK** to call out the channel list, the channel list appears on the right side of the screen.
- Press Navigation buttons to select Favorite icon and press OK button to confirm, then your favorite channel with a heart-shaped icon will appear on the favorite list.

Deleting channels from your 'Favorite' list

- Press **OK** to call out the channel list, the channel list appears on the right side of the screen.
- Press **Right Arrow** > Favorite, then press **OK** > **Left Arrow** to enter the Favorite list.
- Press **Menu** and Navigation button to choose the desired channel, then press **Left Arrow** to choose Delete Fav. Channel and OK button to delete the selected channel.

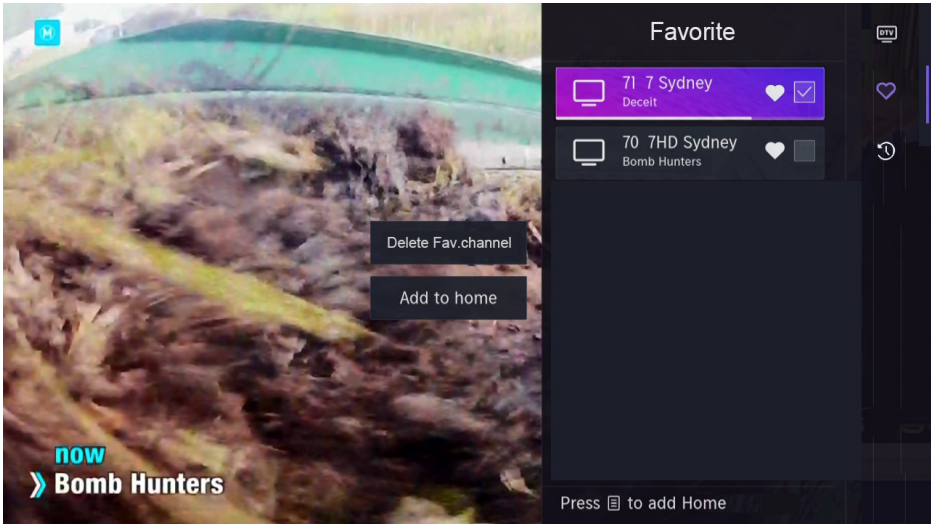

Note:

These steps should be operated under TV inputs.

Before you edit the favorite lists, complete channel scan first.

CONNECTION

Wired LAN

Connecting to the Internet

 > Settings > Network > Network Configuration

You set the TV network by selecting Configuration and press the  button to enter the sub-menu.

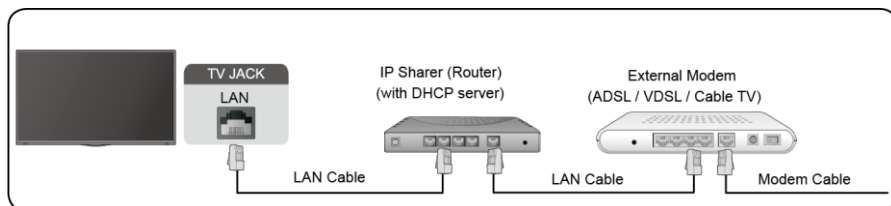

Automatically obtain an IP address

1. If you connect to the wired network, the TV will automatically obtain an IP address and connect to the network.
2. If the connection fails, disconnected message will display for the Ethernet status. Retry or enter the IP settings, and select Manual to input the information again.

Manually enter the IP address

1. Enter the IP settings to select Manual.
2. Enter the IP Address, Netmask, Gateway, DNS Server 1 and DNS Server 2 in the menu.

Note:

You get access to the Internet through your TV.

The default option of IP Settings Mode is DHCP.

Wireless

Connecting to the Internet

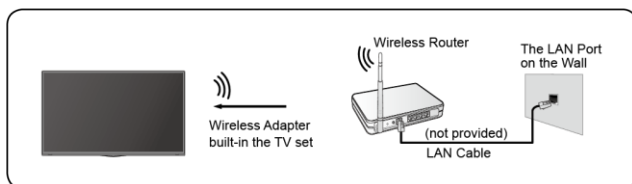

Note:

You get access to the Internet through your TV.

Connect to an available wireless network.

Make sure that you have the wireless router's SSID and password before attempting to connect.

Connecting to a Wireless Network

 > **Settings** > **Network** > **Network Configuration**

You set the TV network by selecting Configuration and press the  button to enter the submenu.

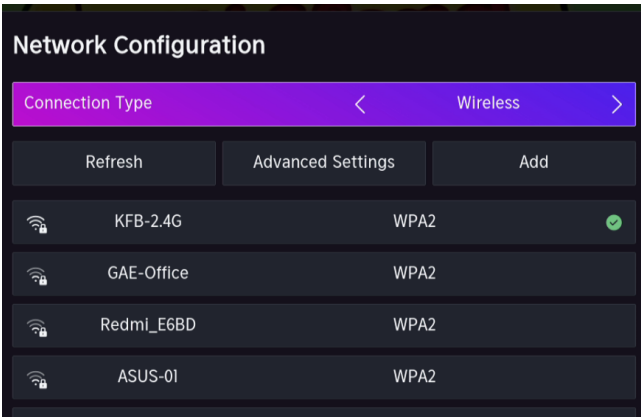

Connection Type

Choose a wireless network connection to access the Internet.

Refresh

Refresh wireless network.

Advanced Settings

Configure the advanced wireless network settings for the TV.

Add

You can add wireless network.

How to connect to WIFI network?

In Network Configuration menu page.

Press navigation button to select the desired wireless router of list below, and press OK button to call out the password box. After input the password, press navigation button to highlight the “Left Arrow” and press OK button to confirm. There is “✓” showing on the right of wireless router means the WIFI connected successfully.

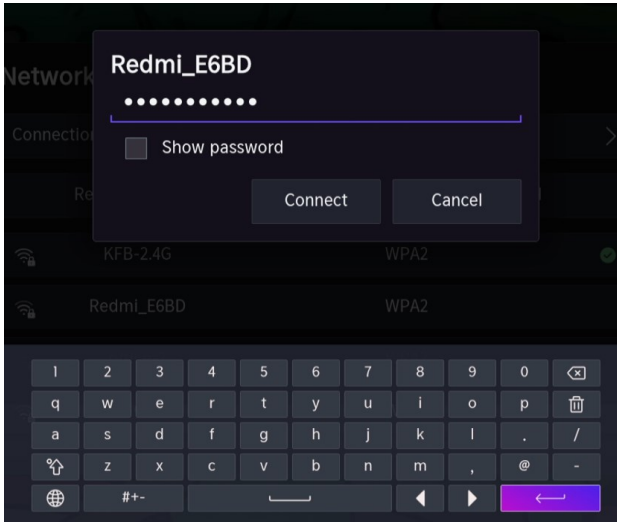

Note:

If no wireless router is found, select **Add** and enter the network name in the SSID.

If no wireless router is found, select **Refresh**.

HDMI-CEC

You can use your TV remote to control the external devices that are connected to the TV by HDMI cable. The external devices need to support HDMI & CEC Function (HDMI-CEC).

Connecting an external device through HDMI-CEC Function  >

Settings > System > HDMI-CEC

1. Set **CEC control** to On.
2. Connect an HDMI-CEC-compliant device to the TV.

3. Turn on the connected external device. The device is automatically connected to the TV. After connection is finished, you can access the menu of the connected device on your TV screen using your TV remote and control the device.

Note:

HDMI cables must be used to connect HDMI CEC-compatible devices to your TV. The HDMI CEC feature of the connected device must be turned on.

If you connect an HDMI device that is not HDMI CEC-compatible, all the HDMI-CEC control features do not work.

Depending on the connected HDMI device, the HDMI-CEC Control feature may not work.

HDMI Device

Connect an HDMI cable from an external A/V equipment.

Some devices such as DVD player require HDMI signal to be set to output in the device's settings. Please consult your device user manual for instructions.

Please note that the HDMI connector provides both video and audio signals, it's not necessary to connect an audio cable.

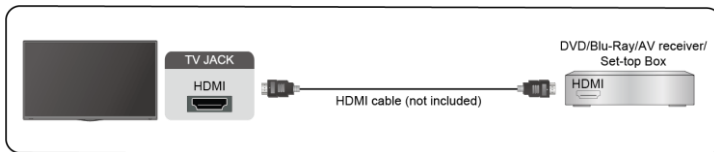

USB Device

Connect the USB devices such as hard drives, USB sticks and digital cameras for browsing photos, listening to music.

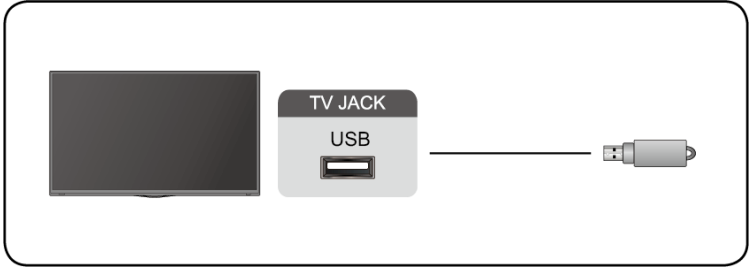

Support format: FAT32.

Multi-screen

Screen Sharing

Mirror content from your device to the TV.

INPUT > Screen Sharing

Turn on the casting function of your Android/Windows10 device.

Find the TV name in the searching list of your device and select it. Wait for the connection progress to complete and the content on your device will be displayed on the TV.

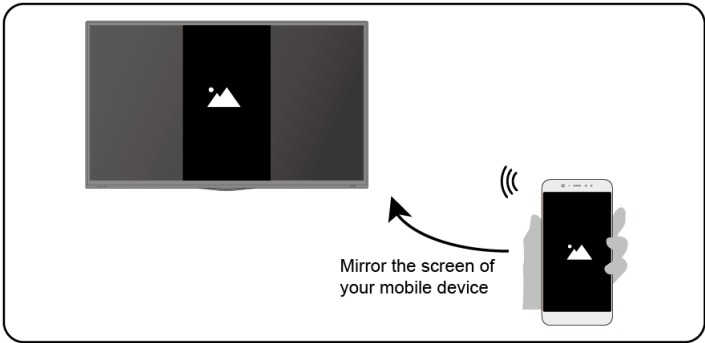

Note:

Some Android devices may not support casting.

Content Sharing

Share media content, like videos, music or photos, from your device to the TV screen.

Before you use this function, turn on Content Sharing at  > **Settings** > **System** > **Mobile Device Connection** > **Content Sharing**.

Establishing Content Sharing connection between the TV and your device

- Turn on the content sharing function of your device.
- Find the TV name in the searching list of your device and select it.
- Wait for the connection progress to complete, and select the content you want to share.

View media content of your device

Press INPUT button on your remote, and select a media content on the screen.

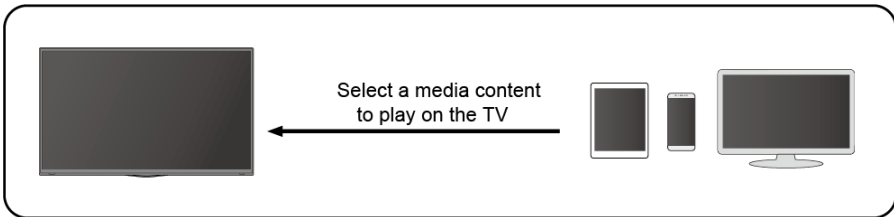

Note:

- Make sure our device and the TV are connected to the same network.
- Some devices may not support content sharing. If your device doesn't support content sharing, you can download an app that supports the function.
- If you want to mirror content from your device, go to **INPUT** > **Screen Sharing**.

Smart Functions

Media

Playing Media contents

 > **Media**

By default, there are **Content Sharing** displayed on the Media screen. If your mobile device is connected to the TV, its name also appears on the Media screen.

Note:

For more information about Content Sharing, refer to its detailed introduction.



 > **Media** > **connected device**

Select the content you want to play on the screen, like pictures, videos and music.



Playing background music during viewing pictures

You need to:

- Choose a picture to playback.
- Press  /  button to call out playbar.
- Select Background Music and choose your music to create a Music Playlist.
- Play the background music during viewing pictures.

Note:

The TV may be support the following file formats:

Medium	File Format
Video	.MP4, .MOV, .MPG, .MPEG, .FLV
Picture	.jpg, .BMP, .PNG, .GIF
Music	.MP3, .AAC, .wav

- For more information about connection to other device, refer to the detailed introduction of each part.

Home

Getting familiar with the Home screen

Run the TV more conveniently by selecting the corresponding sections.

Press  button to enter the Home Page.

Manage apps

Select the item you want to move, long press OK button on remote control to manage.

Download apps

In the HOME page, press navigation button to select “app store” and press OK button to enter the sup-page.

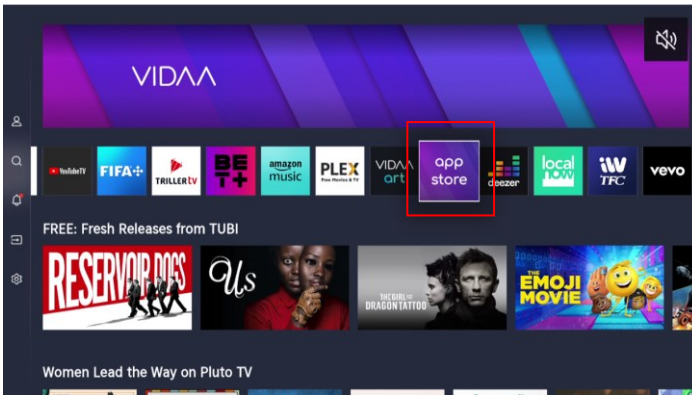

Select the desired app and press OK button to confirm. Highlight “Install” and press OK button to download the app.

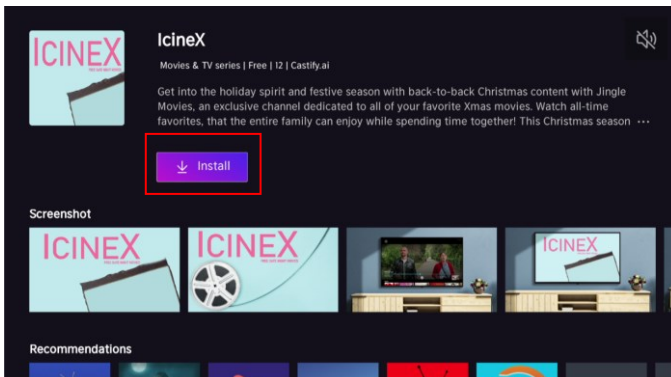

VIDAA Account

Sign in your VIDAA account.

A VIDAA account gives you all the best feature of your smart TV and always keeps it up to date.

Search

Search the app you want.

Notifications

Allow pop-up notifications to appear for useful information and events that occur with your TV.

Select Notifications on the Home screen, and select Settings then display **Advertising, New Arrivals, Warnings And Legal Statements, System Message**, from which you can choose the types of notifications you would like to receive.

Inputs

Select the input you want.

Settings

Display the Settings menu.

Picture and Sound

Adjusting the Picture Quality

Adjust current picture mode to apply to all sources or just current source.

The menu is only for reference. The following modes may differ from the actual product.

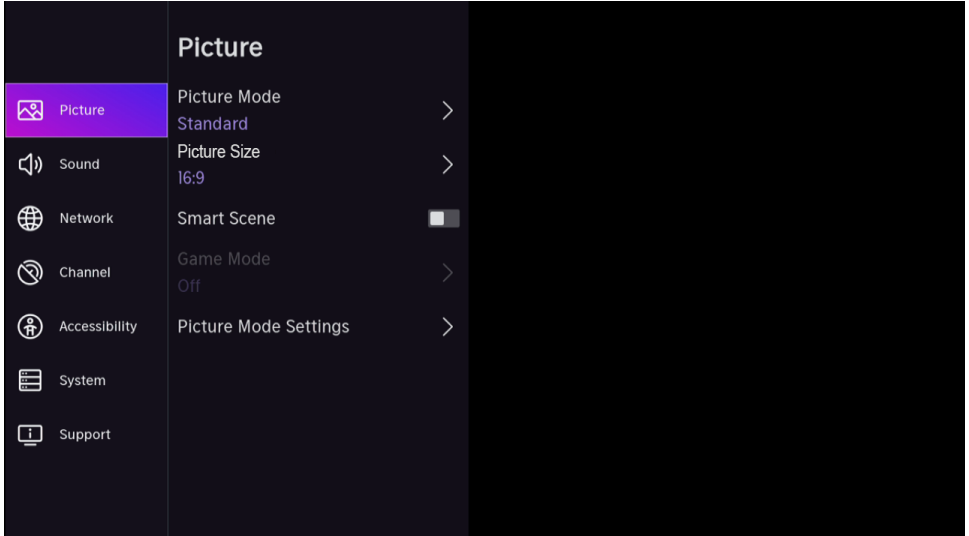

Choosing a picture mode

Settings > Picture > Picture Mode

You can select the Picture Mode that provides the best viewing experience.

- **Vivid**
- **Enhanced(ARC)**
- **Standard**
- **Energy Saving**
- **Theater Day**
- **Theater Night**
- **Sports**

Choosing a Picture Size

 > **Settings** > **Picture** > **Picture Size**

You can adjust the picture aspect ratio based on the content you are watching.

- **Auto**
- **16:9**
- **4:3**
- **Movie Zoom**

Smart Scene

 > **Settings** > **Picture** > **Smart Scene**

Recognise the current scene and enhance the picture quality.

 > **Settings** > **Picture** > **Game Mode**

Optimised for PC or Games consoles. Reduces Input Lag and improves responsiveness. Choosing the Game Mode under ON/OFF

Configuring advanced picture settings

 > **Settings** > **Picture** > **Picture Mode Settings**

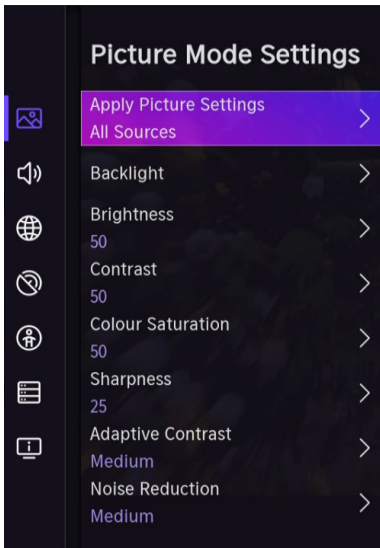

Adjust display setting for each Picture Mode.

- **Apply Picture Settings:** Adjust current picture mode to apply to all sources or just current source.
- **Backlight:** Adjust image backlight. (Optional: Off/Low/High).
- **Brightness** Adjust image brightness.
- **Contrast:** Adjust image contrast.
- **Color Saturation:** Adjust image color density.
- **Sharpness:** Adjust the image edge sharpness.
- **Adaptive Contrast:** Automatically adjust dark areas and light areas of the image to see more details. Press navigation button to select Off/Low/Medium/High.
- **Noise Reduction:** Improve the picture quality by reducing noise. (Optional: Off/Low/Medium/High).
- **MPEG Noise Reduction:** Reduces MPEG block noise to provide clearer edge transitions. (Optional: Off/Low/Medium/High).
- **Colour Temperature:** Adjust the overall color of the image. (Optional: Warm1/Warm2/Standard/Cool).
- **Expert Settings:** Adjust the colour space and Gamma to best suit the content you're viewing.
- **Overscan:** Change the video size setting to crop the edges of the displayed image.
- **Reset Current Mode:** Restore all the picture settings in the current picture mode to the factory default values.

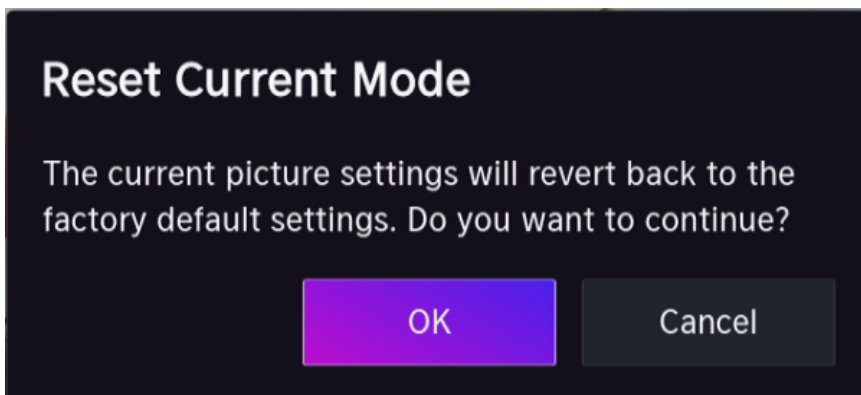

Adjusting the Sound Quality

Adjust current sound mode to apply to all sources or just current source.

The menu is only for reference. The following modes may differ from the actual product.

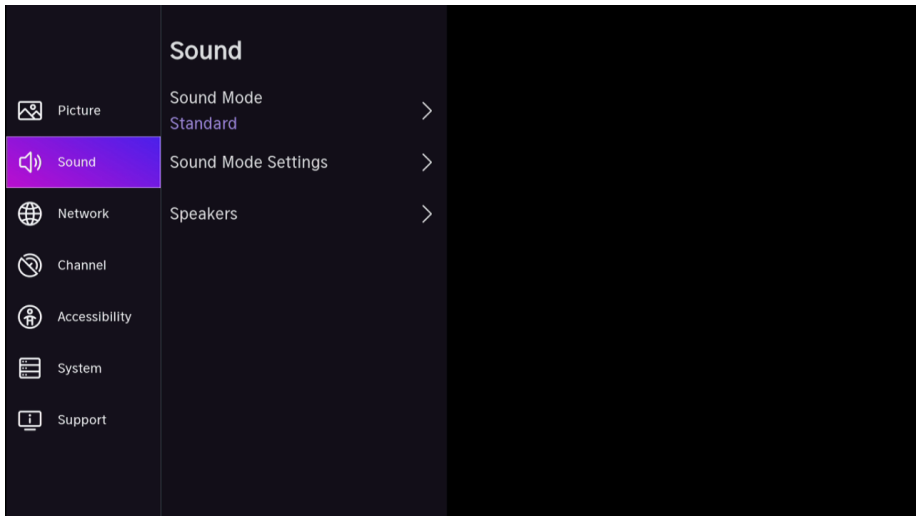

Choosing a sound mode

 > Settings > Sound > Sound Mode

You can select a favorite sound mode suitable for the content type or the listening environment.

- **Standard:** Produced a balanced sound in all environment.
- **Enhanced(ARC):** Enhance both image and sound quality for all input source automatically.
- **Theater:** Increase the surround sound effect and provides a more prominent subwoofer response.
- **Music:** Preserves the original sound. Good for musical programs.
- **Speech:** Low and high frequencies are attenuated to improve the reproduction and clarity of the human voice.
- **Late Night:** Improve the reproduction and clarity of the human voice with a low volume level.
- **Sports:** Optimized sound for watching football.

 > **Settings** > **Sound** > **Sound Mode Settings**

Customize selected Sound Mode.

 > **Settings** > **Sound** > **Speakers**

Select the speakers which you want to use.

Hotel Mode

 > **Settings** > **Sound** > **Speakers**>**Balance**

Press 0548, then the Hotel Mode will display.

Press OK to set the Hotel Mode On.

Press OK again to set the Hotel Mode OFF.

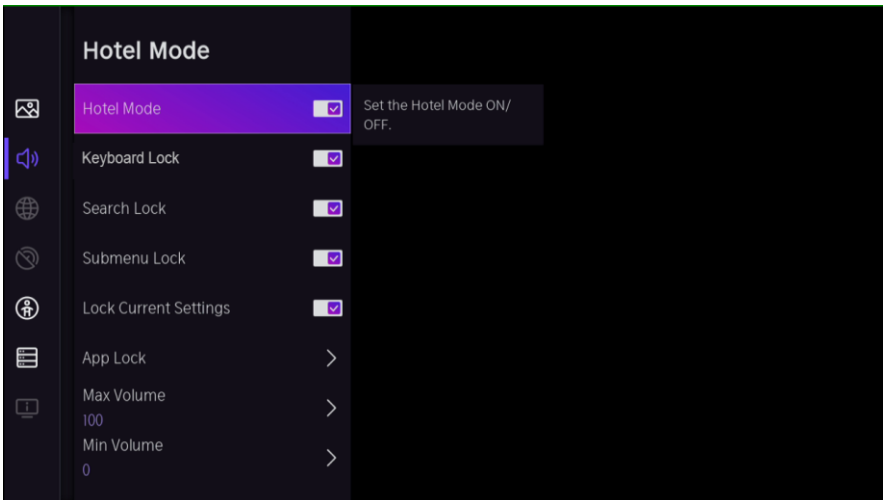

Channel

Press  > **Settings > Channel**

Press Navigation buttons to select the option that you want to adjust in the Channel menu.
Press OK button to adjust.

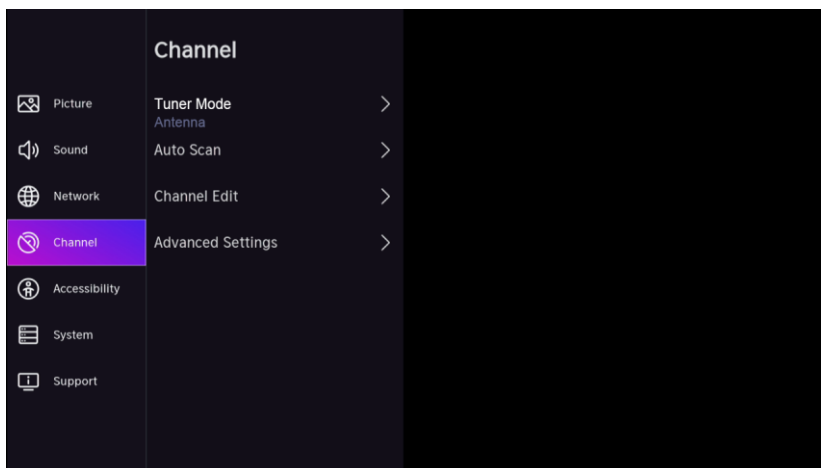

Tuner Mode

Select if you receive TV channel over the air(antenna) or trough a cable set top box.

Auto Scan

Automatic search can search for effective program channel automatically.

Channel Edit

Manually edit the channel list to your preference.

Advanced Settings

Adjust advanced settings for channel.

Accessibility

Press Navigation button to select Accessibility

 > Settings > Accessibility

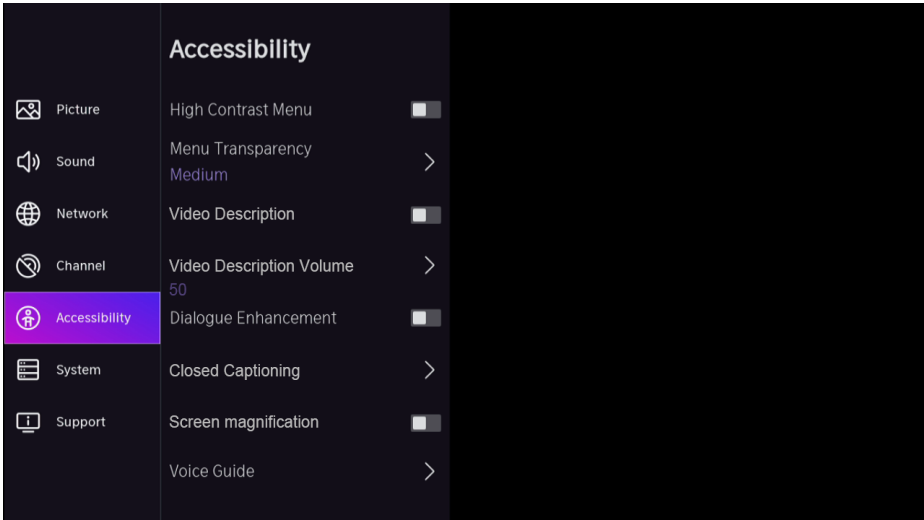

- **High Contrast Menu:** Turn High Contrast Menu On or Off.
- **Menu Transparency:** Set the transparency of menu. (Optional: Off/Medium/High)
- **Video Description:** Enables broadcasted descriptive audio for visually impaired.
- **Video Description Volume:** Independently adjust the volume of voice over.
- **Dialogue Enhancement:** Enable or disable dialogue enhancement.
- **Closed Captioning:** Allow customization of closed caption text display.
- **Screen Magnification:** Allow visually impaired/partially sighted viewers to magnify an area of the screen.
- **Voice Guide:** Allows customization of spoken menu language.

System and Support

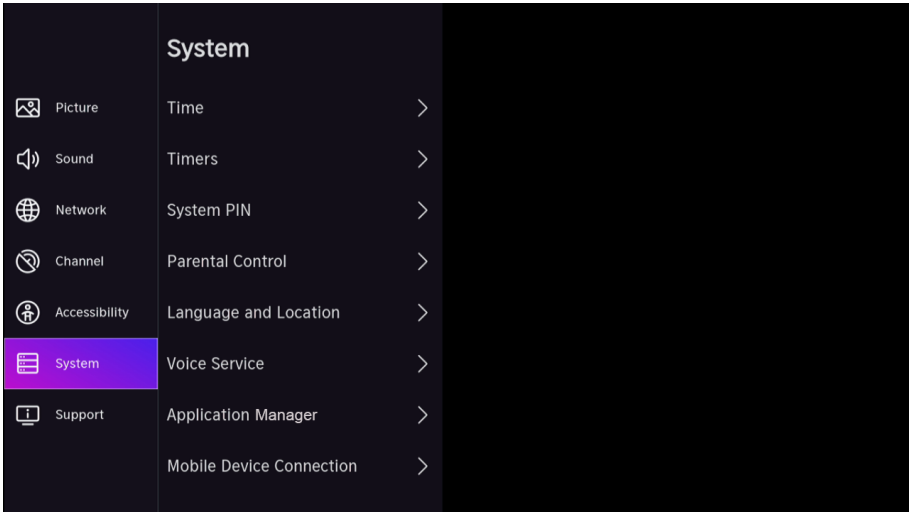

Setting Time

 > **Settings** > **System** > **Time**

Set the current time based on your location.

- **Time Format**

Set the time to display in a 12 or 24-hour format.

- **Date/Time**

Set the date and time.

- **Time Zone**

Set the time zone.

- **Daylight Savings**

Select whether to apply Daylight Savings Time to the TV.

Using the timers

 > **Settings** > **System** > **Timer**

Adjust the timer settings to suit your preference.

- **Sleep Timer**

Set the sleep timer to automatically turn the TV Off within a specified time: Off, 15 Minutes, 30 Minutes, 60 Minutes, 90 Minutes, 120 Minutes, User Defined.

- **Power On Timer**

Set the clock for the time you want the TV to turn on automatically. You can set the time only once or set the time in specified date weekly.

- **Power Off Timer**

Set the clock for the time you want the TV to turn off automatically. You can set the time only once or set the time in specified date weekly.

- **Menu Timeout**

Set the amount of time that you would like for the menu to display: Off, 10s, 20s, 30s, 60s.

- **Auto Sleep**

Set the amount of time that you'd like for TV auto power off without any activity: Off, 3H, 4H.

- **Auto Standby with No Signal**

TV will go to standby if there is no signal after the set time: Off, 15 minutes.

System PIN

 > **Settings > System > System PIN**

Change the PIN that you use to access Parental Control, Auto Channel Scan and Reset to Factory Default.

Parental Control

 > **Settings > System > Parental Control**

Turn on Parental Controls to prevent children from being able to view certain content.

Language and Location

 > **Settings > System > Language and Location**

Choose the language of the TV and your location.

Voice Service

 > **Settings > System > Voice Service**

Download the VIDAA APP on your mobile, then you can use your voice to control the TV, other smart home devices and more.

Application Manager

 > **Settings > System > Application Manager**

Set up Application preferences.

Mobile Device Connection

 > **Settings > System > Mobile Device Connection**

Connection management of a mobile device, smartphone, or personal computer.

HDMI & CEC

 > **Settings > System > HDMI & CEC**

Control your TV and CEC- enabled devices with one remote.

Advanced Settings

 > **Settings > System > Advanced settings**

Access the Advanced Settings menu.

Press  > **Settings > Support**

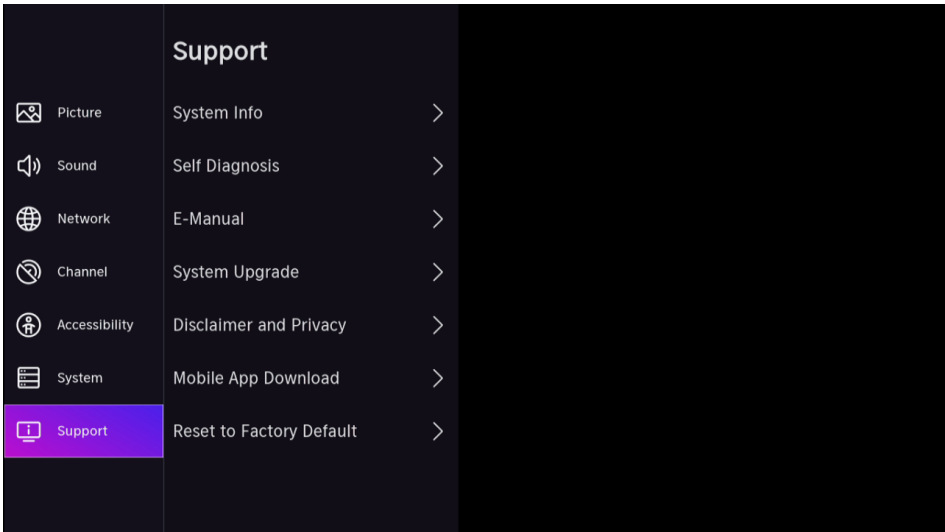

System Info

View System information.

Self Diagnosis

Perform self diagnosis to test sound, picture and connections.

E-Manual

Launch E-Manual and get to know more about your TV.

System Upgrade

Set your TV to receive the latest firmware.

Disclaimer and Privacy

Click to read our term and policy.

Mobile App Download

Install mobile app on your smartphone to control your TV. This app is available on both Android and iOS.

Reset to Factory Default

Reset your TV to the factory settings.

MAINTENANCE

- Be sure to press POWER button to set the player to the standby mode and disconnect the power plug before maintaining the player.
- Wipe the player with a dry, soft cloth.
- If the surface is extremely dirty, wipe clean with a cloth which has been dipped in a weak soap-water solution and wrung out thoroughly, and then wipe again with a dry cloth.
- Never use alcohol, benzene, thinner, cleaning fluid or other chemicals. And do not use compressed air to remove dust.

WALL MOUNTING

- Contact a professional for assistance when wall mounting your TV. We are not responsible for any damage to the product or injury to yourself, if you mount the TV on your own.
- Do not wall mount the TV while TV is turned on. It may cause personal injury due to electric shock.
- Use standard BM4*10mm screws (4 pieces, not included) to mount this TV.

Back of your TV

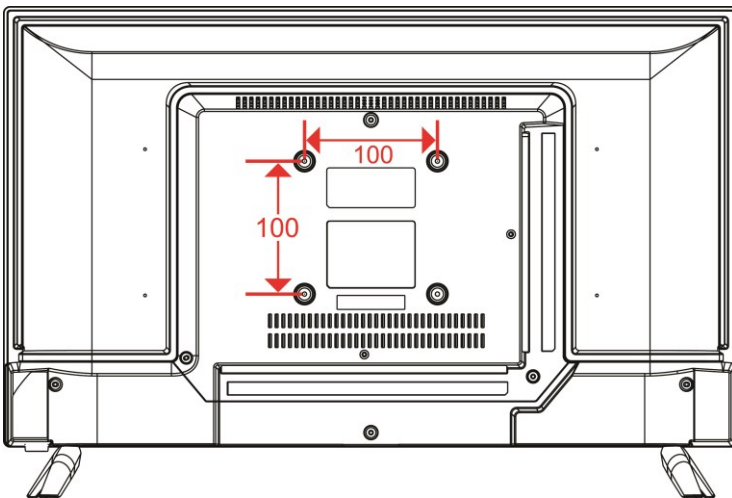

STAND INSTALLATION

Your TV is packaged with the Stand and the Cabinet separated. Before enjoying this TV, please carry out the Stand Installation according to the instructions below.

Step 1

Place the TV faced down on a soft cloth or cushion to prevent the panel from being damaged.

Step 2

Align the stand and the bottom of this TV.

Step 3

Tighten the included screws with a screw driver.

NOTES:

- Unplug the power plug first when installing or removing the TV Stand.
- To avoid any damage to this TV, contact one or more partner for assistance when installing or removing the TV stand.

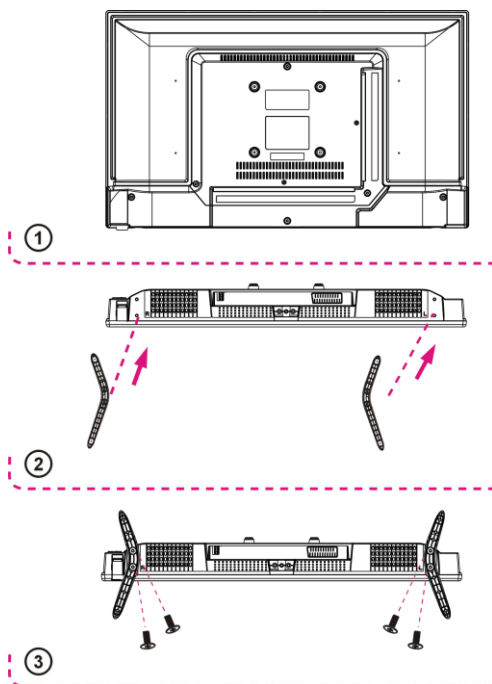

SPECIFICATIONS

Display Device	23.6 inch LED TV
Resolution	1366×768
Display Colors	16.7M
Contrast Ratio	3000:1 (Typ)
Aspect Ratio	16:9
Life Time	30,000 Hrs
Multimedia Playback	Music
	Photo
	Video
POWER SOURCE	AC 100-240V, 50/60Hz + DC 12V
POWER CONSUMPTION	Max.42W
OPERATION TEMPERATURE	-5°C to 35°C
MEASUREMENT	553 (W)×166(D)×370(H) mm
WEIGHT	Approx. 2.26 kg

USB 2.0/Max 128G

Medium	File Format
Video	.MP4, .MOV, .MPG, .MPEG, .FLV
Picture	.jpg, .BMP, .PNG, .GIF
Music	.MP3, .AAC, .WAV

Specifications are subject to change without notice.

GENERAL TROUBLESHOOTING

Check the following points before assuming malfunctions of this unit:

Symptom[COMMON]	Remedy
No power.	Insert the power plug securely into the power outlet.
No picture.	Ensure that the equipment is connected properly.
<ul style="list-style-type: none"> ● No sound. ● Distorted sound. 	<ul style="list-style-type: none"> ● Ensure that the equipment is connected properly. ● Ensure that the input setting for the TV and stereo system are correct. ● Adjust the master volume to a suitable volume by pressing VOL+/VOL- button.
No operations can be performed with the remote control unit.	<ul style="list-style-type: none"> ● Check the batteries are installed with the correct polarities. ● The batteries are exhausted: Replace them with new ones. ● Point remote control at the remote control sensor and operate it again. ● Operate the remote control unit at a distance of no more than 6m from the remote control sensor. ● Remove the obstacles between the remote control and remote control sensor.
No key operation (by the main unit and/or the remote control unit) is effective.	Disconnect the power plug from power source and then reconnect it. (This TV may not be operating properly due to lightning, static electricity or some other factors.)
Symptom[TV]	Remedy
No or poor picture.	<ul style="list-style-type: none"> ● Adjust antenna or use an external antenna. ● Relocate the unit near a window (if inside a building). ● Move units away from this product that causes interference. ● Do Auto Tuning again. ● Try another channel.
No sound or poor sound.	<ul style="list-style-type: none"> ● Check the audio settings. ● Press MUTE button on remote control to cancel mute function. ● Unplug the headphone.
Noise or other interface.	Electronic equipment near the unit is causing interface. Relocate the unit or move the equipment.

CHANNEL SCAN UNDRE “Antenna /Cable”

STEP 1

Press MENU key on remote control.
Press UP/DOWN arrow key to select Settings item, and press OK key to enter the sub-page.
Press Left/Right arrow key to select Channel item, and press OK key to enter the sub-page.

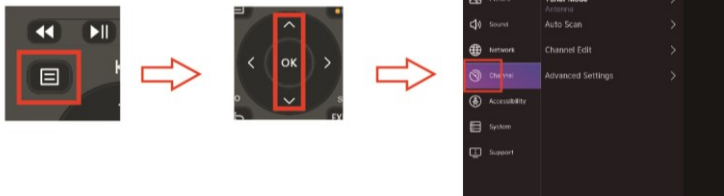

STEP 2

Highlight Tuner Mode item and press OK key to enter the sub-page. Press Up/Down arrow key to select Antenna or Cable, and press OK key to confirm. Press MENU key to return the previous page.

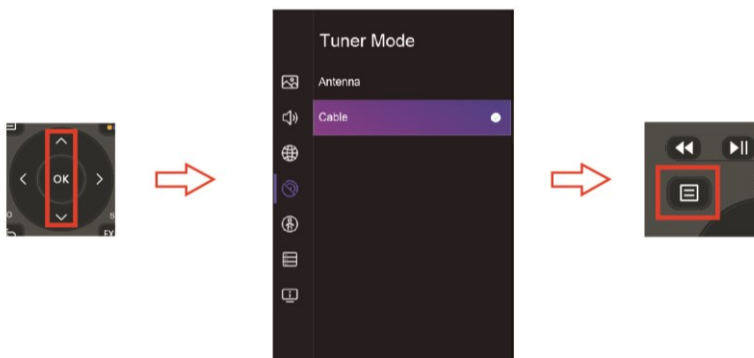

STEP 3

Press Up/Down arrow key to select Auto Scan and press OK key to start scanning.

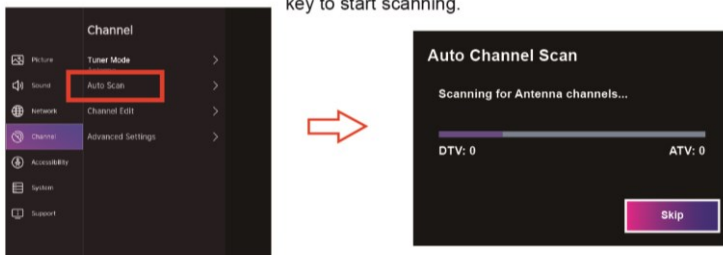

If you have your TV connected with a Cable box or Satellite Receiver box any other Video Input source you don't need to run a channel scan, please follow the procedure below to see the input source.

1. Power on TV and press "INPUT" button on remote control.
2. Press LEFT/RIGHT/UP/DOWN navigation key on remote control to select AV or HDMI input source and press OK key to enter it.

How to change "Input Source" signal

1. Power on TV and press "INPUT" key on remote control.



2. Press navigation key to select desired source.

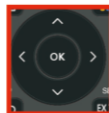

3. Press OK key on remote control to confirm, and input source will show on TV.



Warranty

Basic Warranty Statement

Supersonic Inc. ("Supersonic") warrants this product to the original purchaser ONLY, to be free from defects in materials and workmanship under normal use, for ninety (90) DAYS from the date of original purchase. Proof of purchase (receipt) required.

Please visit <http://www.supersonicinc.com/warranty> for additional information.