

# ViewSonic®



---

## **VA2756-mhd/VA2756-mh/ VA2756-h Display User Guide**

---

IMPORTANT: Please read this User Guide to obtain important information on installing and using your product in a safe manner, as well as registering your product for future service. Warranty information contained in this User Guide will describe your limited coverage from ViewSonic Corporation, which is also found on our web site at <http://www.viewsonic.com> in English, or in specific languages using the Regional selection box in the upper right corner of our website. "Antes de operar su equipo lea cuidadosamente las instrucciones en este manual"

---

**Model No. VS17296**

**P/N: VA2756-MHD/VA2756-MH/VA2756-H**

# Thank you for choosing ViewSonic

As a world leading provider of visual solutions, ViewSonic is dedicated to exceeding the world's expectations for technological evolution, innovation, and simplicity. At ViewSonic, we believe that our products have the potential to make a positive impact in the world, and we are confident that the ViewSonic product you have chosen will serve you well.

Once again, thank you for choosing ViewSonic !



# Contents

<b>1. Cautions and Warnings .....</b>	<b>1</b>
<b>2. Getting Started .....</b>	<b>4</b>
2-1. Package Contents .....	5
2-2. The Exterior of the Monitor .....	6
2-3. Hardware Installation .....	7
2-4. Quick Installation .....	10
2-5. Power On .....	13
2-6. Driver Installation (Windows 10 Setup) .....	14
<b>3. Adjusting the Screen Image .....</b>	<b>15</b>
3-1. Setting the Timing Mode .....	15
3-2. Using the Control Panel .....	16
<b>4. OSD Menu Introduction .....</b>	<b>18</b>
4-1. OSD Menu Tree .....	18
4-2. OSD Menu Explanation .....	22
4-3. Monitor Setting Management .....	27
<b>5. Specifications .....</b>	<b>28</b>
<b>6. Troubleshooting .....</b>	<b>30</b>
<b>7. Cleaning and Maintenance .....</b>	<b>31</b>
Safe Cleaning Practices .....	31
Product Upgradeability and Repairability .....	33

**8. Compliance Information ..... 34**

- 8-1. FCC Compliance Statement ..... 34
- 8-2. Industry Canada Statement ..... 35
- 8-3. CE Conformity for European Countries..... 35
- 8-4. Declaration of RoHS2 Compliance ..... 36
- 8-5. Indian Restriction of Hazardous Substances ..... 38
- 8-6. Product Disposal at End of Product Life ..... 38

**9. Copyright Information..... 39**

- Customer Service ..... 40
- Limited Warranty..... 42
- Mexico Limited Warranty ..... 47

# 1. Cautions and Warnings

1. Read these instructions completely before using the equipment.
2. Keep these instructions in a safe place.
3. Heed all warnings and follow all instructions.
4. Sit at least 18" / 45cm from the monitor.
5. When installing the monitor, please leave 10cm of open space around the monitor for ventilation safety purposes.
6. Always handle the display with care when moving it.
7. Exercise caution when removing the rear cover of the monitor. This monitor contains high-voltage parts.
8. Do not use this equipment near water. To reduce the risk of fire or electric shock, do not expose the monitor to rain or moisture.
9. Avoid exposing the monitor to direct sunlight or other sources of sustained heat. Do not install near any heat sources such as radiators, heat registers, stoves, or other devices (including amplifiers) that may increase the temperature of the monitor to dangerous levels.
10. Clean with a soft, dry cloth. If further cleaning is required, see "Cleaning the Display" in this guide for further instructions.
11. Avoid touching the screen. Skin oils are difficult to remove.
12. Do not touch, rub or apply pressure to the monitor screen, as it may permanently damage the screen.
13. Place the monitor in a well-ventilated area. Do not place anything on the display that prevents heat dissipation.
14. Do not place heavy objects on the display, video cable, or power cord.

15. If smoke appears, an abnormal noise, or a strange odor is present, immediately switch the display off and call your dealer or ViewSonic. It is dangerous to continue using the display.
16. Do not attempt to circumvent the safety provisions of the polarized or grounding-type plug. A polarized plug has two blades with one wider than the other. A grounding type plug has two blades and a third grounding prong. The wide blade and the third prong are provided for your safety. If the plug does not fit into your outlet, obtain an adaptor and do not attempt to force the plug into the outlet.
17. When connecting to a power outlet, DO NOT remove the ground prong. Please ensure grounding prongs are NEVER REMOVED.
18. Protect the power cord from being treaded upon or pinched, particularly at the plug, and at the point where it emerges from the equipment. Be sure that the power outlet is located near the equipment so that it is easily accessible.
19. Only use attachments/accessories specified by the manufacturer.
20. Use only with the cart, stand, tripod, bracket, or table specified by the manufacturer, or sold with the equipment. When a cart is used, use with caution when moving the cart/equipment combination to avoid injury from tipping over.
21. Unplug this equipment when it will be unused for long periods of time.



22. Refer all servicing to qualified service personnel. Service will be required when the unit has been damaged in any way, such as: if the power-supply cord or plug is damaged, if liquid is spilled onto or objects fall into the unit, if the unit is exposed to rain or moisture, or if the unit does not operate normally or has been dropped.
23. Excessive sound pressure from ear-/headphones can cause hearing damage /hearing loss.
24. Adjustment of the volume control as well as the equalizer may increase the ear-/ headphones output voltage and therefore, the sound volume level.
25. The factors influencing the ear-/headphones output other than those specified by the manufacturer (e.g. operating system, equalizer software, firmware, driver) may increase the ear-/ headphone output voltage and therefore, the sound volume level.

## 2. Getting Started

Should problems arise and the product you have purchased needs to be returned for any reason, please keep the original packaging, registration form, and receipt. Having these items will make it easier for you to verify your product and repair, refund and/or return your product to you.

If you have any problems with your product or questions that have not been addressed in the User Guide, please contact customer service for help.

Important! Save the original box and all packing material for your future shipping needs.

**NOTE:** The word “Windows” in this user guide refers to Microsoft Windows operating system.

## 2-1. Package Contents

Your monitor package includes:

- Monitor
- Power cord
- Video cable<sup>1</sup>
- Quick Start Guide

### **NOTE:**

<sup>1</sup> The video cables included in your package may vary depending on your country. Please contact your local reseller for more information.

## 2-2. The Exterior of the Monitor

### A. Front

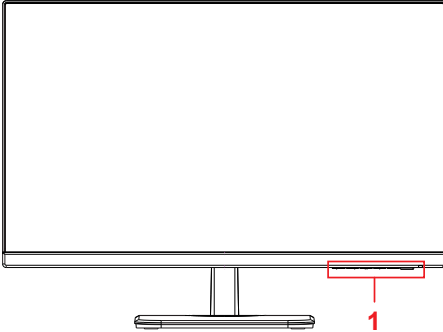

### B. Left and Right

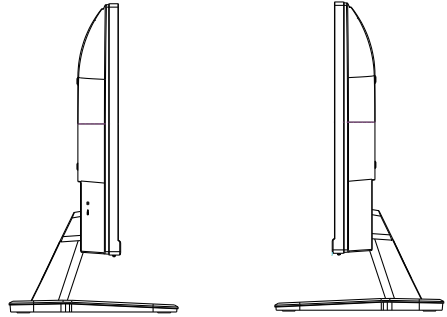

### C. Rear

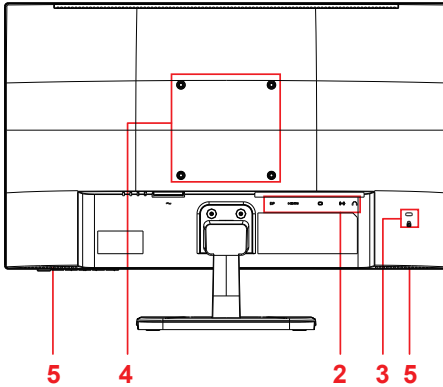

#### 1. Control panel

(Expanded in 3-1)

#### 2. I/O port (input/output)

This area should include all I/O connection options, as well as the power input connector (Expanded in 2-4)

#### 3. Kensington security slot

(Expanded in 2-3 section B)

#### 4. VESA wall mounting

This area on the back of the monitor\*. For the VESA wall mounting installation steps, please see 2-3 section A for additional instructions.

#### 5. Speaker

(for VA2756-mhd/VA2756-mh)

# 2-3. Hardware Installation

## A. Base Attachment Procedure

1

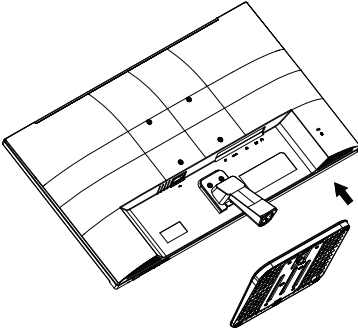

2

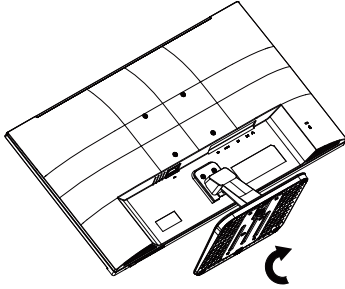

3

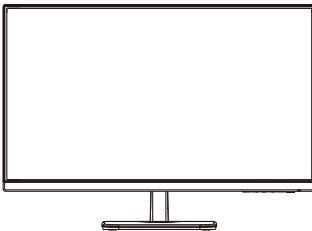

## B. Base Removal Procedure

1

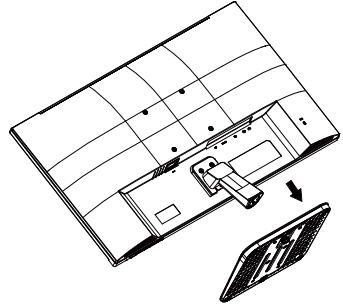

2

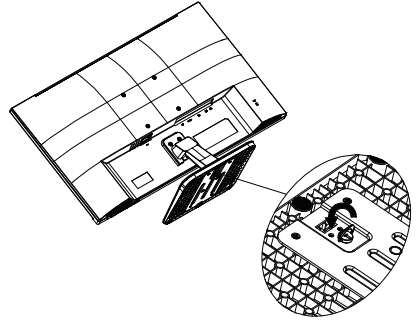

3

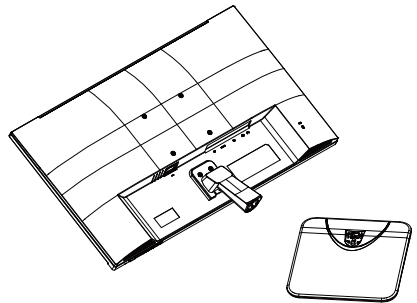

## C. Wall Mounting (Optional)

**NOTE:** For use only with a UL Listed Wall Mount Bracket.

To obtain a wall-mounting kit or height adjustment base, contact ViewSonic® or your local dealer. Refer to the instructions that come with the base mounting kit. To convert your display from a desk-mounted to a wall-mounted display, do the following:

1. Find VESA compatible wall-mounting kit which meets the quaternions in section "Specifications".
2. Verify that the power button is turned Off, then disconnect the power cord.
3. Lay the display face down on a towel or blanket.
4. Remove the base. (Screws removal might be required.)
5. Attach the mounting bracket from the wall mounting kit using screws of the appropriate length.
6. Attach the display to the wall, following the instructions in the wall-mounting kit.

## D. Using the Security Lock

The security connector is located on the back side of the monitor. For more information on installation and usage.

Below is an example of setting up the lock on a table for your reference.

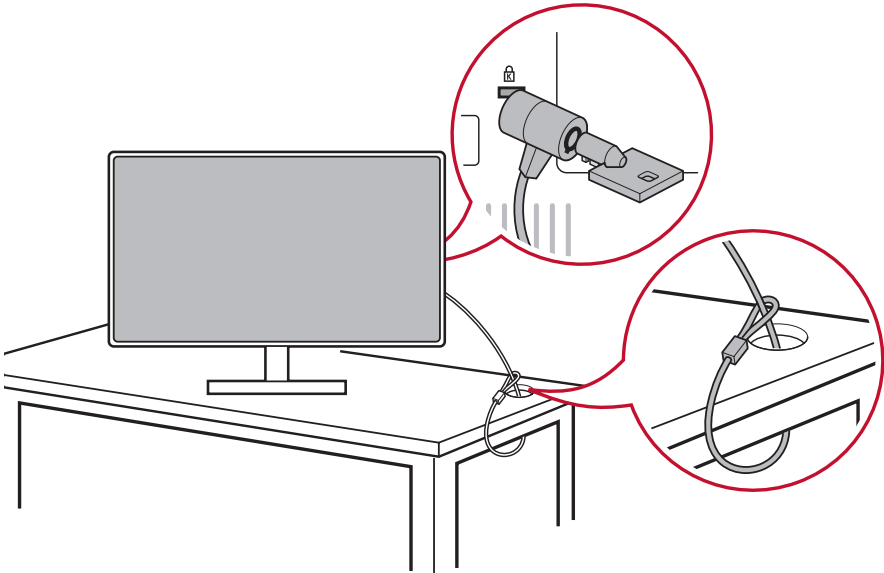

\*This picture is for reference only

## 2-4. Quick Installation

### Connect Signal Cables

1. Make sure both the LCD monitor and computer are turned OFF.
2. Remove rear panel covers if necessary.
3. Connect the signal cables from the LCD monitor to the computer.

### VA2756-mhd

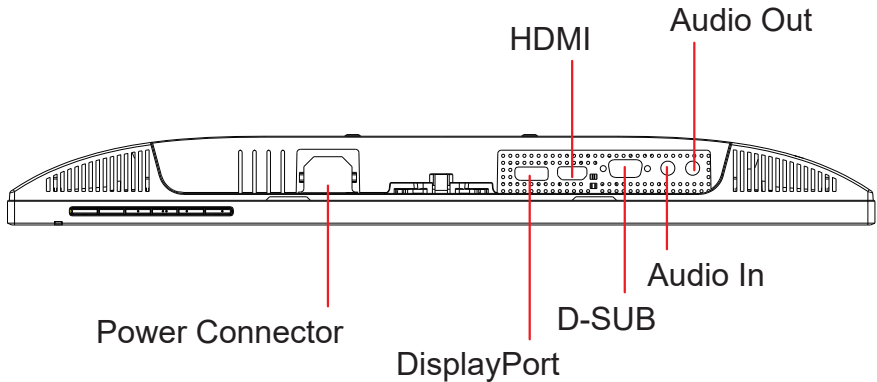

## VA2756-mh

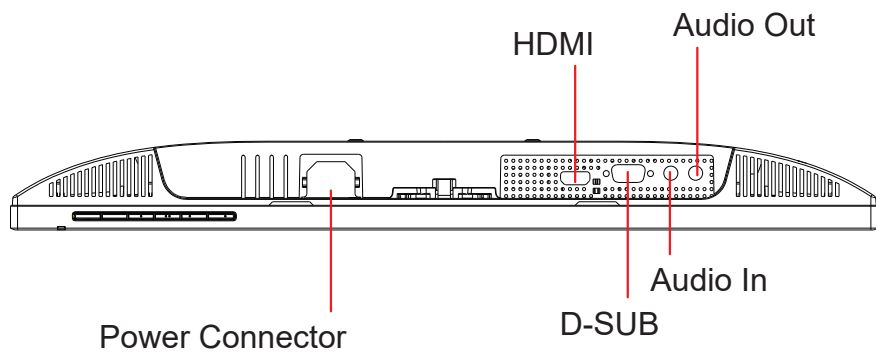

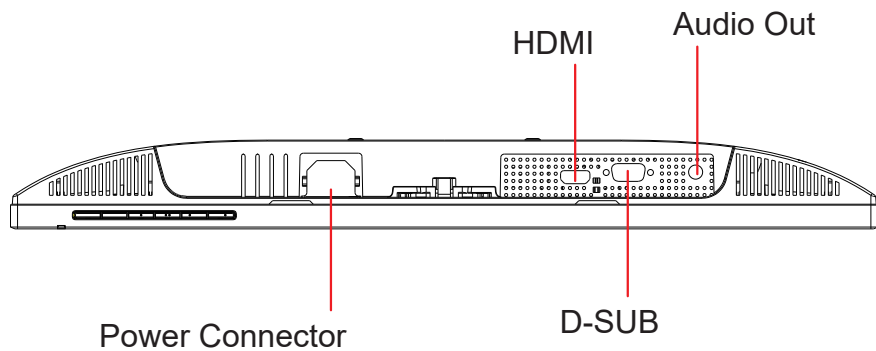

## VA2756-h

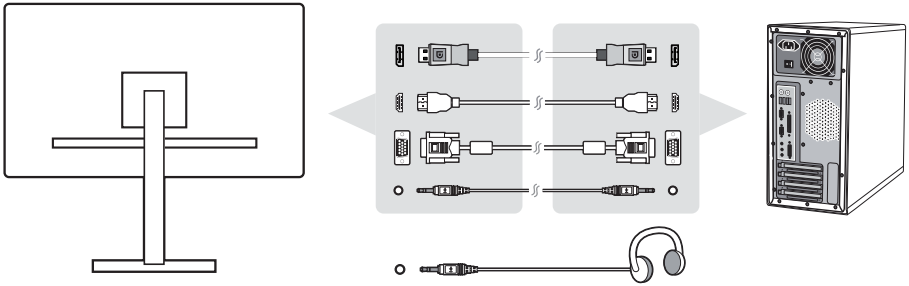

3.A. Please do not connect the DisplayPort out on the monitor to the DisplayPort or mini DP connector on the computer. DisplayPort out is used for daisy chain connection (Explained in section C)



		HDMI	DP		
VA2756-h	✓	✓			✓
VA2756-mhd	✓	✓	✓	✓	✓
VA2756-mh	✓	✓		✓	✓

### 3.B. Video and Audio Cable

For a MAC with Thunderbolt output, please connect the mini DP end of the “mini DP to DisplayPort cable” to the Thunderbolt output of MAC. And connect the other end of the cable to the DisplayPort connector on the rear of the monitor.

\*This picture is for reference only

### 3.C. Power Cable (and AC/DC adapter if required)

Connect the female connector of AC power cord to the power connector of monitor, and the AC plug of AC power cord to the AC outlet.

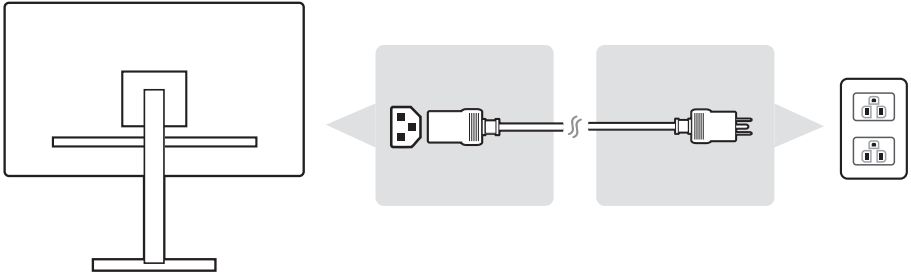

## 2-5. Power On

### Turn On LCD Monitor and Computer

Turn ON the LCD Monitor, then turn ON the computer. This particular order (LCD monitor before computer) is important.

## 2-6. Driver Installation (Windows 10 Setup)

In order to install the driver, first connect your monitor to your PC, boot up your PC (make sure to first turn on the monitor first) and make sure your internet is available. When the PC has finished booting up, your PC should auto- detect the monitor.

To ensure auto-detection is successful, go to ‘Advanced Display Settings’ under your system ‘Display Settings’ (screen resolution) window. There you can verify your ViewSonic monitor has been recognized by your PC in the ‘Color Management’ section of your advanced settings.

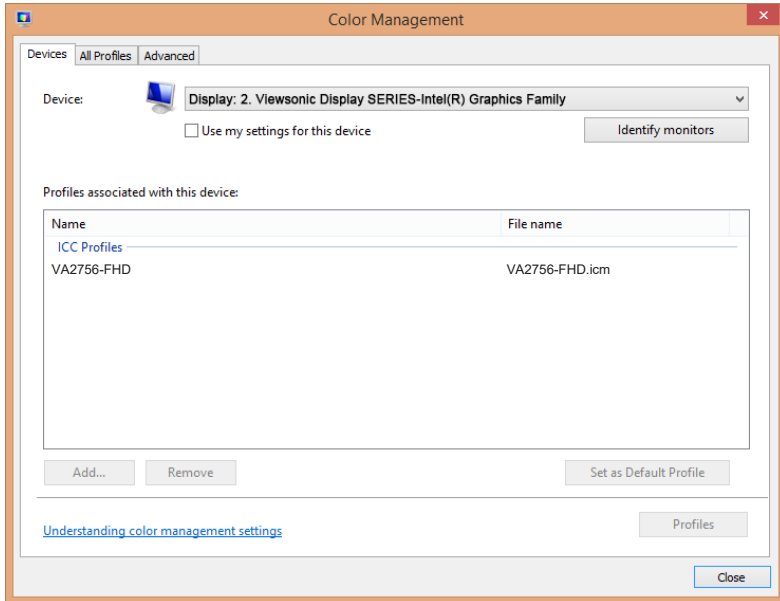

If your PC has not auto-detected the monitor, but is still functioning, you can download the driver from ViewSonic website and install it then restart your computer and follow the steps above again. It is not imperative for your computer to detect the monitor for normal use, but it is recommended.

If you encounter additional problems or have questions, please contact Customer Support.

# 3. Adjusting the Screen Image

## 3-1. Setting the Timing Mode

Set your monitor resolution to its recommended resolution (see section "specification") to get the best experience possible, with brilliant color and crisp text. Here is how:

1. Go to your display resolution settings window (each operating system will have a different process to get there).
2. Next, adjust the display resolution setting to match your monitor's native resolution. This will provide you with your best usage experience.

If you have difficulty setting the resolution or you do not see recommended resolution as an available option, you may need a newer video card driver. Contact your computer or video card manufacturer to obtain the latest driver.

- If necessary, make small adjustments using H. POSITION and V. POSITION until the screen image is completely visible. (\*for analog only). (The black border around the edge of the screen should barely touch the illuminated "active area" of the LCD monitor.)

## 3-2. Using the Control Panel





After setting the timing mode, use the buttons on the front or rear control panel to display and adjust OSD for screen image adjustment.



\* The position refer to section 2.2

### Bezel & OSD symbol explanation

The bezel symbol explanation is stated below:

	Standby Power On/Off
	<b>NOTE:</b> Power light Blue = ON Orange = Power Saving
	Short Cut icon that allows users to choose or Input Select Contrase/Brightness, View mode, Audio adjust setting they would like to activate for monitor use.
	Main menu icon that allows users to access the main menu.

## The OSD Menu and OSD Quick-Menu Symbol explanations and their functional uses are stated below.



Activation symbol to turn the various modes on when operating the menu system.



Activation symbol to exit, go back or deactivate the desired function that is selected.



Scrolls through menu options and adjusts the monitor controls.



Symbol used to go back or revert back to the previously selected menu



Information shortcut select button, which gives users access to the information of the monitor currently in use.



Main menu icon that allows users to access the main menu. Hold down the icon for a few seconds to turn off the main menu



Left and right icons toggle your selected choice horizontally.



The Energy Gauge displays the percentage of maximum energy output being consumed by the monitor in real time.

# 4. OSD Menu Introduction

## 4-1. OSD Menu Tree

For an explanation of the OSD tree and pertaining functions, please refer to the 4-2 OSD explanation below. The OSD tree visually represents the complete OSD menu that can be accessed by your monitor. If you aren't sure where an option/function is or cannot locate a specific feature, please utilize the OSD tree below.



**View Mode**



**Audio**



**Contrast / Brightness**



**Input Select**

Menu			
Shortcut Function	ViewMode	Standard	
		Game	
		Movie	
		Web	
		Text	
		MAC	
		Mono	
	Volume	On	0~100
		Mute	
	Contrast/Brightness	Contrast	0~100
Brightness		0~100	
Input Select	D-SUB		
	HDMI		
	DISPLAYPORT*	* for VA2756-mhd	
Main Menu	Input Select		
	Audio Adjust		
	ViewMode		
	Color Adjust		
	Manual Image Adjust		
	Setup Menu		



Menu			
Input Select	D-Sub		
	HDMI		
	DisplayPort*		* for VA2756-mhd
Audio Adjust	Volume	0~100	
	Audio Input	DISPLAYPORT*	* for VA2756-mhd
		HDMI	
	Audio In*		* for VA2756-mhd/VA2756-mh
ViewMode	Standard		
	Game		
	Movie		
	Web		
	Text		
	MAC		
	Mono		

**Menu**

<b>Color Adjust</b>	Contrast/Brightness	Contrast	0~100		
		Brightness	0~100		
	Color Temperature	SRGB			
		Bluish			
		Cool			
		Native			
		Warm			
		User Color	Red	0~100	
			Green	0~100	
	Blue		0~100		
	Color Space	Auto			
		RGB			
		YUV			
	Color Range	Auto			
Full Range					
Limited Range					
<b>Manual Image Adjust</b>	Auto Image Adjust				
	Horizontal Size	0~100			
	H./V. Position	Horizontal Position	0~100		
		Vertical Position	0~100		
	Fine Tune	0~100			
	Sharpness	0,25,50,75,100			
	Blue Light Filter	0~100			
	Aspect Ratio	4:3			
		5:4			
		16:9			
		16:10			
	Overscan	On			
		Off			
	Black Stabilization	0,10...50...90,100			
Advanced DCR	0, 25, 50, 75, 100				
Response Time	Standard				
	Advanced				
	Ultra Fast				

## Menu

### Setup Menu

Language	English
	Français
	Deutsch
	Español
	Italiano
	Suomi
	Svenska
	Русский
	Türkçe
	Češka
	日本語
	한국의
	繁體中文
	简体中文
Resolution Notice	On
	Off
Information	
OSD Timeout	5, 15, 30, 60
OSD Background	On
	Off
Power Indicator	On
	Off
Auto Power Off	On
	Off
Sleep	30 Minutes
	45 Minutes
	60 Minutes
	120 Minutes
	Off
ECO Mode	Standard
	Optimize
	Conserve
DisplayPort 1.1* * for VA2756-mhd	On
	Off
Auto Detect	On
	Off
DDC/CI	On
	Off
Memory Recall	

## 4-2. OSD Menu Explanation

**NOTE:** The OSD menu items listed in this section indicate the entire OSD items of all models. Some of these items may not exist in your product OSD. Please disregard OSD menu item explanations if they do not exist in your OSD Menu. Please refer to the 4-1 OSD Tree (above), for your monitor's available OSD menu items. Please refer to the OSD explanation below (in alphabetical order), for a clearer explanation of what each function does.

### **A** **Advanced DCR**

Advanced DCR technology automatically detects the image signal and intelligently controls the backlight brightness and color, to improve on the ability to make the black blacker in a dark scene, and make the white whiter in a bright environment.

### **Auto Detect**

If current input source is no signal, monitor will automatically switch to next input option. This function on some model is disabled by default.

### **Audio Adjust**

adjusts the volume, mutes the sound, or toggles between inputs if you have more than one source.

### **Auto Image Adjust**

automatically sizes, centers, and fine tunes the video signal to eliminate waviness and distortion. Press the [MENU] button to obtain a sharper image.

**NOTE:** Auto Image Adjust works with most common video cards. If this function does not work on your display, then lower the video refresh rate to 60 Hz and set the resolution to its pre-set value.

## **B** **Black stabilization**

ViewSonic's Black stabilization provides heightened visibility and detail by brightening dark scenes.

## **Blue light filter**

Adjusts the filter that blocks high-energy blue light for a safer experience for our users.

## **Brightness**

Adjusts background black levels of the screen image.

## **C** **Color adjust**

Provides several color adjustment modes, to help adjust the color settings to fit our users' needs.

## **Color range**

Adjusts the color range, allowing users to adjust the range in RGB and YUV color settings.

## **Color space**

Allows users to choose which color space they would like to use for monitor color output (RGB, YUV).

## C Color temperature

Allows users to select specific color temperature settings to further customize their viewing experience.

	Explanation
sRGB	Standard color space used for the windows system, digital cameras and the Internet.
NATIVE	Native is a default color temperature. Recommended for general graphic design and regular use.

## Contrast

Adjusts the difference between the image background (black level) and the foreground (white level).

## Custom

Providing even more support, three customizable 'Custom' settings are available to help match individual preferences and adapt to every type of game on the market. Select one of the 'Custom' options (Custom 1, Custom 2 etc. ) in the Menu and adjust the advanced options. After exiting the setting will automatically be saved under that particular 'Custom' setting or rename the setting to your liking by selecting 'Rename'. You can access your saved 'GAME MODE' settings with the Quick Menu as well.

## G Game mode

Integrating a gaming-oriented OSD design including pre-calibrated FPS, RTS and MOBA gaming settings, each mode is functionally customized with in-game testing and adjustments made for the best blend of color and technology. To access the game mode first open the Main Menu setting, then go to 'ViewMode', select 'Game' and change your 'GAMER' settings from there.

## **I** Information

Displays the timing mode (video signal input) coming from the graphics card in the computer, the LCD model number, the serial number, and the ViewSonic® website URL. See your graphics card's user guide for instructions on changing the resolution and refresh rate (vertical frequency).

**NOTE:** VESA 1024 x 768 @ 60Hz (example) means that the resolution is 1024 x 768 and the refresh rate is 60 Hertz.

## **Input select**

Toggles between the various input options that are available for that particular monitor.

## **L** Low input lag

ViewSonic offers low input lag, utilizing a monitor process reducer, which decreases signal latency. Under the low input lag submenu, you can select the appropriate speed for your desired use from the two options

## **M** Manual image adjust

Displays the Manual Image Adjust menu. You can manually set a variety of image quality adjustments.

## **Memory recall**

Returns the adjustments back to factory settings if the display is operating in a factory Preset Timing Mode listed in the Specifications of this manual.

**Exception:** This control does not affect changes made with the Language Select or Power Lock setting

## **O** Overscan

Can be used to adjust the aspect ratio of the input signal received by your monitor to adjust the image so it appears on the monitor.

## **R** **Response time**

Adjusts the response time, creating smooth images without streaking, blurring or ghosting. A low response time is perfect for the most graphic-intensive gaming, and provides amazing visual quality while watching sports or action movies. Setting the menu to 'Ultra Fast' is advised.

## **Resolution notice**

The notice tells users that the current viewing resolution is not the correct native resolution. This notice will appear in the display settings window, when setting up the display resolution.

## **Recall**

Resets the ViewMode monitor settings.

## **S** **Setup menu**

Adjusts On-screen Display (OSD) settings. Many of these settings can activate on-screen display notifications so users do not have to reopen the menu.

## **Sharpness**

Adjusts the sharpness and picture quality of the monitor.

## **V** **ViewMode**

ViewSonic's unique ViewMode feature offers "Game," "Movie," "Web," "Text," and "Mono" presets. These presets are specifically designed to deliver an optimized viewing experience for different screen applications.

## 4-3. Monitor Setting Management

### **OSD Timeout**

The OSD Timeout function, allows users to choose how long the OSD will reside on the screen after in-activity (number of seconds).

### **OSD Background**

The OSD Background function allows users to turn off the OSD background while selecting and adjusting OSD settings.

### **Power Indicator**

The power indicator is the light that displays whether the monitor is on or off.

### **Auto Power Off**

Selecting Auto Power Off, allows the monitor to shut its power off after a certain amount of time.

### **Sleep**

This setting allows users to adjust the time of inactivity before the monitor goes on a reduced power mode. The screen will be on 'sleep mode' during this time.

### **Eco Mode**

Allows users to choose between various modes, based on power consumption.

### **DDC/CI (Display Data Channel Command Interface)**

Activating this setting allows monitor control via the graphics card.

# 5. Specifications

---

<b>LCD</b>	Type	TFT (Thin Film Transistor), Active Matrix 1920X1080 LCD, 0.311 mm x 0.311 mm pixel pitch
	Display Size	Metric: 69 cm Imperial: 27" (27" viewable)
	Color Filter	RGB vertical stripe
	Glass Surface	Anti-Glare

---

<b>Input Signal</b>	Video Sync	RGB Analog (75 ohms, 0.7 / 1.0 Vp-p) Separate Sync HDMI (TMDS digital, 100 ohms) DP (TMDS digital, 100 ohms) (for VA2756-mhd only) $f_h$ :24-83 kHz, $f_v$ :50-75 Hz
---------------------	------------	---

---

<b>Compatibility</b>	PC	Up to 1920X1080 Non-interlaced
	Macintosh	Power Macintosh up to 1920X1080 (Supported by limited graphic cards)

---

<b>Resolution<sup>1</sup></b>	Recommended	1920X1080@60Hz
	Supported	1680 x 1050 @ 60 Hz 1440 x 900 @ 60 Hz 1280 x 1024 @ 60, 75 Hz 1280 x 720 @ 60 Hz 1024 x 768 @ 60, 70, 75 Hz 800 x 600 @ 56, 60, 72, 75 Hz 640 x 480 @ 60, 72, 75 Hz 720 x 400 @ 70 Hz

---

<b>Power Adaptor<sup>2</sup></b>	Input Voltage	100-240 VAC, 50/60 Hz (auto switch)
----------------------------------	---------------	-------------------------------------

---

<b>Display area</b>	Full Scan	598 mm (H) x 336 mm (V) 23.5" (H) x 13.2" (V)
<b>Operating conditions</b>	Temperature	+32 °F to +104 °F (0 °C to +40 °C)
	Humidity	10% to 90% (non-condensing)
	Altitude	To 16,000 feet
<b>Storage conditions</b>	Temperature	-4 °F to +140 °F (-20 °C to +60 °C)
	Humidity	5% to 90% (non-condensing)
	Altitude	To 40,000 feet
<b>Dimensions</b>	Physical	540 mm(W) x 390 mm(H) x 198 mm(D)) 21.3" (W) x 15.3" (H) x 7.8" (D)

### Wall Mount

Max Loading	Hole pattern (W x H; mm)	Interface Pad (W x H x D)	Pad Hole	Screw Q'ty & Specification
14kg	100mm x 100mm	115 mm x 115 mm x 2.6 mm	Ø 5mm	4 piece M4 x 10mm

Do not screw torque over 12 kgf, as it may damage the display.

<b>Weight</b>	Physical	10.8 lb (4.9 kg)
<b>Power saving modes</b>	On <sup>3</sup>	31W (Typical)
	Off	<0.5W

<sup>1</sup> Do not set the graphics card in your computer to exceed these timing mode; doing so may result in permanent damage to the display.

<sup>2</sup> Please use the power adaptor from ViewSonic® or authorized source only.

<sup>3</sup> The test condition follows EEL standard



The terms HDMI, HDMI High-Definition Multimedia Interface, HDMI trade dress and the HDMI Logos are trademarks or registered trademarks of HDMI Licensing Administrator, Inc.

# 6. Troubleshooting

## No power

- Make sure the power button (or switch) is ON.
- Make sure the A/C power cord is securely connected to the display.
- Plug another electrical device (like a radio) into the power outlet to verify that the outlet is supplying proper voltage.

## Power is ON but no screen image

- Make sure the video cable supplied with the display is properly secured to the video output port on the back of the computer. If the other end of the video cable is not attached permanently to the display, properly secure it to the display.
- Adjust brightness and contrast.
- If you are using an Macintosh older than G3, you need a Macintosh adapt

## Wrong or abnormal colors

- If any colors (red, green, or blue) are missing, check the video cable to make sure it is securely connected. Loose or broken pins in the cable connector could cause an improper connection.
- Connect the display to another computer.
- If you have an older graphics card, contact ViewSonic® for a non-DDC adapter.

## Control buttons do not work

- Press only one button at a time.

# 7. Cleaning and Maintenance

## Safe Cleaning Practices

- Make sure the display is turned off.
- Never spray or pour any liquid directly onto the screen or case.

### To clean the screen:

1. Wipe the screen with a clean, soft, lint-free cloth. This removes dust and other particles.
2. If the screen is still not clean, apply a small amount of non-ammonia, non-alcohol based glass cleaner onto a clean, soft, lint-free cloth, and wipe the screen.

### To clean the case:

1. Use a soft, dry cloth.
2. If the case is still not clean, apply a small amount of a non-ammonia, non-alcohol based, mild non-abrasive detergent onto a clean, soft, lint-free cloth, then wipe the surface.

## Disclaimer

- ViewSonic® does not recommend the use of any ammonia or alcohol-based cleaners on the display screen or case. Some chemical cleaners have been reported to damage the screen and/or case of the display.
- ViewSonic will not be liable for damage resulting from use of any ammonia or alcoholbased cleaners.

## Caution:

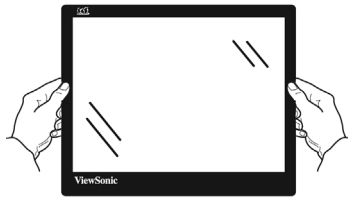

Handle the monitor on the edges only.

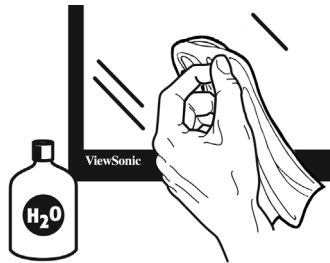

Clean with water on a soft cotton cloth only.

# Product Upgradeability and Repairability

The following is a list of hardware features available for at least 5 years after the sale of the product.	Upgradable	Repairable	Replaceable
Main Processor(s) or SOC	No	No	Yes
Memory	N/A	N/A	N/A
HDD	N/A	N/A	N/A
Wireless Networking Capability	N/A	N/A	N/A
Graphics Card	N/A	N/A	N/A
Rechargeable Battery	N/A	N/A	N/A
Fan Assembly	N/A	N/A	N/A
Camera	N/A	N/A	N/A
Fingerprint Reader	N/A	N/A	N/A
Display Assembly	No	No	Yes
Keyboard	N/A	N/A	N/A
Internal Power Supply	No	No	Yes

**Note:** \*N/A = Not applicable for the product.

# 8. Compliance Information

**NOTE:** This section addresses all connected requirements and statements regarding regulations. Confirmed corresponding applications shall refer to nameplate labels and relevant markings on unit.

## 8-1. FCC Compliance Statement

This device complies with part 15 of FCC Rules. Operation is subject to the following two conditions: (1) this device may not cause harmful interference, and (2) this device must accept any interference received, including interference that may cause undesired operation.

This equipment has been tested and found to comply with the limits for a Class B digital device, pursuant to part 15 of the FCC Rules. These limits are designed to provide reasonable protection against harmful interference in a residential installation. This equipment generates, uses, and can radiate radio frequency energy, and if not installed and used in accordance with the instructions, may cause harmful interference to radio communications. However, there is no guarantee that interference will not occur in a particular installation. If this equipment does cause harmful interference to radio or television reception, which can be determined by turning the equipment off and on, the user is encouraged to try to correct the interference by one or more of the following measures:

- Reorient or relocate the receiving antenna.
- Increase the separation between the equipment and receiver.
- Connect the equipment into an outlet on a circuit different from that to which the receiver is connected.
- Consult the dealer or an experienced radio/TV technician for help.

**Warning:** You are cautioned that changes or modifications not expressly approved by the party responsible for compliance could void your authority to operate the equipment.

## 8-2. Industry Canada Statement

CAN ICES-3 (B)/NMB-3(B)

## 8-3. CE Conformity for European Countries

**CE** The device complies with the EMC Directive 2014/30/EU and Low Voltage Directive 2014/35/EU.

### Following information is only for EU-member states:

The mark shown to the right is in compliance with the Waste Electrical and Electronic Equipment Directive 2012/19/EU (WEEE). The mark indicates the requirement NOT to dispose the equipment as unsorted municipal waste, but use the return and collection systems according to local law.



## 8-4. Declaration of RoHS2 Compliance

This product has been designed and manufactured in compliance with Directive 2011/65/EU of the European Parliament and the Council on restriction of the use of certain hazardous substances in electrical and electronic equipment (RoHS2 Directive) and is deemed to comply with the maximum concentration values issued by the European Technical Adaptation Committee (TAC) as shown below:

<b>Substance</b>	<b>Proposed Maximum Concentration</b>	<b>Actual Concentration</b>
Lead (Pb)	0.1%	< 0.1%
Mercury (Hg)	0.1%	< 0.1%
Cadmium (Cd)	0.01%	< 0.01%
Hexavalent Chromium (Cr <sup>6+</sup> )	0.1%	< 0.1%
Polybrominated biphenyls (PBB)	0.1%	< 0.1%
Polybrominated diphenyl ethers (PBDE)	0.1%	< 0.1%

**Certain components of products as stated above are exempted under the Annex III of the RoHS2 Directives as noted below:**

Examples of exempted components are:

1. Mercury in cold cathode fluorescent lamps and external electrode fluorescent lamps (CCFL and EEFL) for special purposes not exceeding (per lamp):
  - (1) Short length ( $\leq 500$  mm): maximum 3.5 mg per lamp.
  - (2) Medium length ( $> 500$  mm and  $\leq 1,500$  mm): maximum 5 mg per lamp.
  - (3) Long length ( $> 1,500$  mm): maximum 13 mg per lamp.
2. Lead in glass of cathode ray tubes.
3. Lead in glass of fluorescent tubes not exceeding 0.2% by weight.
4. Lead as an alloying element in aluminium containing up to 0.4% lead by weight.
5. Copper alloy containing up to 4% lead by weight.
6. Lead in high melting temperature type solders (i.e. lead-based alloys containing 85% by weight or more lead).
7. Electrical and electronic components containing lead in a glass or ceramic other than dielectric ceramic in capacitors, e.g. piezo-electronic devices, or in a glass or ceramic matrix compound.

## **8-5. Indian Restriction of Hazardous Substances**

Restriction on Hazardous Substances statement (India) This product complies with the “India E-waste Rule 2011” and prohibits use of lead, mercury, hexavalent chromium, polybrominated biphenyls or polybrominated diphenyl ethers in concentrations exceeding 0.1 weight % and 0.01 weight % for cadmium, except for the exemptions set in Schedule 2 of the Rule.

## **8-6. Product Disposal at End of Product Life**

ViewSonic respects the environment and is committed to working and living green. Thank you for being part of Smarter, Greener Computing.

Please visit ViewSonic website to learn more.

### **USA & Canada:**

<http://www.viewsonic.com/company/green/recycle-program/>

**Europe:** <http://www.viewsoniceurope.com/eu/support/call-desk/>

**Taiwan:** <https://recycle.epa.gov.tw/>

# 9. Copyright Information

Copyright ©ViewSonic® Corporation, 2022. All rights reserved.

Macintosh and Power Macintosh are registered trademarks of Apple Inc.

Microsoft, Windows, and the Windows logo are registered trademarks of Microsoft Corporation in the United States and other countries.

ViewSonic, the three birds logo, OnView, ViewMatch, and ViewMeter are registered trademarks of ViewSonic Corporation.

VESA is a registered trademark of the Video Electronics Standards Association. DPMS, DisplayPort, and DDC are trademarks of VESA.

ENERGY STAR® is a registered trademark of the U.S. Environmental Protection Agency (EPA).

As an ENERGY STAR® partner, ViewSonic Corporation has determined that this product meets the ENERGY STAR® guidelines for energy efficiency.

Disclaimer: ViewSonic Corporation shall not be liable for technical or editorial errors or omissions contained herein; nor for incidental or consequential damages resulting from furnishing this material, or the performance or use of this product.

In the interest of continuing product improvement, ViewSonic Corporation reserves the right to change product specifications without notice. Information in this document may change without notice.

No part of this document may be copied, reproduced, or transmitted by any means, for any purpose without prior written permission from ViewSonic Corporation.

# Customer Service

For technical support or product service, see the table below or contact your reseller.

**NOTE:** You will need the product serial number.

Country/ Region	Website	Country/ Region	Website
<b>Asia Pacific &amp; Africa</b>			
Australia	<a href="http://www.viewsonic.com/au/">www.viewsonic.com/au/</a>	Bangladesh	<a href="http://www.viewsonic.com/bd/">www.viewsonic.com/bd/</a>
中国 (China)	<a href="http://www.viewsonic.com.cn">www.viewsonic.com.cn</a>	香港 (繁體中文)	<a href="http://www.viewsonic.com/hk/">www.viewsonic.com/hk/</a>
Hong Kong (English)	<a href="http://www.viewsonic.com/hk-en/">www.viewsonic.com/hk-en/</a>	India	<a href="http://www.viewsonic.com/in/">www.viewsonic.com/in/</a>
Indonesia	<a href="http://www.viewsonic.com/id/">www.viewsonic.com/id/</a>	Israel	<a href="http://www.viewsonic.com/il/">www.viewsonic.com/il/</a>
日本 (Japan)	<a href="http://www.viewsonic.com/jp/">www.viewsonic.com/jp/</a>	Korea	<a href="http://www.viewsonic.com/kr/">www.viewsonic.com/kr/</a>
Malaysia	<a href="http://www.viewsonic.com/my/">www.viewsonic.com/my/</a>	Middle East	<a href="http://www.viewsonic.com/me/">www.viewsonic.com/me/</a>
Myanmar	<a href="http://www.viewsonic.com/mm/">www.viewsonic.com/mm/</a>	Nepal	<a href="http://www.viewsonic.com/np/">www.viewsonic.com/np/</a>
New Zealand	<a href="http://www.viewsonic.com/nz/">www.viewsonic.com/nz/</a>	Pakistan	<a href="http://www.viewsonic.com/pk/">www.viewsonic.com/pk/</a>
Philippines	<a href="http://www.viewsonic.com/ph/">www.viewsonic.com/ph/</a>	Singapore	<a href="http://www.viewsonic.com/sg/">www.viewsonic.com/sg/</a>
臺灣 (Taiwan)	<a href="http://www.viewsonic.com/tw/">www.viewsonic.com/tw/</a>	ประเทศไทย	<a href="http://www.viewsonic.com/th/">www.viewsonic.com/th/</a>
Việt Nam	<a href="http://www.viewsonic.com/vn/">www.viewsonic.com/vn/</a>	South Africa & Mauritius	<a href="http://www.viewsonic.com/za/">www.viewsonic.com/za/</a>
<b>Americas</b>			
United States	<a href="http://www.viewsonic.com/us">www.viewsonic.com/us</a>	Canada	<a href="http://www.viewsonic.com/us">www.viewsonic.com/us</a>
Latin America	<a href="http://www.viewsonic.com/la">www.viewsonic.com/la</a>		

Country/ Region	Website	Country/ Region	Website
<b>Europe</b>			
Europe	<a href="http://www.viewsonic.com/eu/">www.viewsonic.com/eu/</a>	France	<a href="http://www.viewsonic.com/fr/">www.viewsonic.com/fr/</a>
Deutschland	<a href="http://www.viewsonic.com/de/">www.viewsonic.com/de/</a>	Қазақстан	<a href="http://www.viewsonic.com/kz/">www.viewsonic.com/kz/</a>
Россия	<a href="http://www.viewsonic.com/ru/">www.viewsonic.com/ru/</a>	España	<a href="http://www.viewsonic.com/es/">www.viewsonic.com/es/</a>
Türkiye	<a href="http://www.viewsonic.com/tr/">www.viewsonic.com/tr/</a>	Україна	<a href="http://www.viewsonic.com/ua/">www.viewsonic.com/ua/</a>
United Kingdom	<a href="http://www.viewsonic.com/uk/">www.viewsonic.com/uk/</a>		

# Limited Warranty

## ViewSonic® Display

### **What the warranty covers:**

ViewSonic warrants its products to be free from defects in material and workmanship during the warranty period. If a product proves to be defective in material or workmanship during the warranty period, ViewSonic will, at its sole option, and as your sole remedy, repair or replace the product with a similar product. Replacement Product or parts may include remanufactured or refurbished parts or components. The repair or replacement unit or parts or components will be covered by the balance of the time remaining on the customer's original limited warranty and the warranty period will not be extended. ViewSonic provides no warranty for any third-party software whether included with the product or installed by the customer, installation of any unauthorized hardware parts or components (e.g. Projector Lamps). (Please refer to: "What the warranty does not cover" section)

### **How long the warranty is effective:**

ViewSonic displays are warranted for between 1 and 3 years, depending on your country of purchase, for all parts including the light source and for all labour from the date of the first consumer purchase.

Authorized service providers will offer replacement or repair for up to five (5) years from the date of the first consumer purchase. Should the display no longer be under warranty, the repair cost will be paid by the purchaser.

### **Who the warranty protects:**

This warranty is valid only for the first consumer purchaser.

## **What the warranty excludes and does not cover:**

Any product on which the serial number has been defaced, modified or removed.

Damage, deterioration or malfunction resulting from:

1. Accident, misuse, neglect, fire, water, lightning, or other acts of nature, unauthorized product modification, or failure to follow instructions supplied with the product.
2. Repair or attempted repair by anyone not authorized by ViewSonic.
3. Damage to or loss of any programs, data or removable storage media.
4. Software or data loss occurring during repair or replacement.
5. Any damage of the product due to shipment.
6. Removal or installation of the product.
7. Causes external to the product, such as electric power fluctuations or failure.
8. Use of supplies or parts not meeting ViewSonic's specifications.
9. Normal wear and tear.
10. Failure of owner to perform periodic product maintenance as stated in User Guide, such as cleaning of user-cleanable projector filters.
11. Any other cause which does not relate to a product defect.
12. Damage caused by static (non-moving) images displayed for lengthy periods of time (also referred to as image burn-in).
13. Software - Any third-party software included with the product or installed by the customer.

14. Hardware/Accessories/Parts/Components - Installation of any unauthorized hardware, accessories, consumable parts or components (e.g. Projector Lamps).
15. Damage to, or abuse of, the coating on the surface of the display through inappropriate cleaning as described in product User Guide.
16. Removal, installation, and set-up service charges, including wall-mounting of product.

### **How to get service:**

1. For information about receiving service under warranty, contact ViewSonic Customer Support (Please refer to Customer Support page). You will need to provide your product's serial number.
2. To obtain warranty service, you will be required to provide (a) the original dated sales slip, (b) your name, (c) your address, (d) a description of the problem, and (e) the serial number of the product.
3. Take or ship the product freight prepaid in the original container to an authorized ViewSonic service center or ViewSonic.
4. For additional information or the name of the nearest ViewSonic service center, contact ViewSonic.

### **Limitation of implied warranties:**

There are no warranties, express or implied, which extend beyond the description contained herein including the implied warranty of merchantability and fitness for a particular purpose.

**Exclusion of damages:**

ViewSonic's liability is limited to the cost of repair or replacement of the product. ViewSonic shall not be liable for:

1. Damage to other property caused by any defects in the product, damages based upon inconvenience, loss of use of the product, loss of time, loss of profits, loss of business opportunity, loss of goodwill, interference with business relationships, or other commercial loss, even if advised of the possibility of such damages.
2. Any other damages, whether incidental, consequential or otherwise.
3. Any claim against the customer by any other party.
4. Repair or attempted repair by anyone not authorized by ViewSonic.

**Effect of state law:**

This warranty gives you specific legal rights, and you may also have other rights which vary from state to state. Some states do not allow limitations on implied warranties and/or do not allow the exclusion of incidental or consequential damages, so the above limitations and exclusions may not apply to you.

**Sales outside the U.S.A. and Canada:**

For warranty information and service on ViewSonic products sold outside of the U.S.A. and Canada, contact ViewSonic or your local ViewSonic dealer.

The warranty period for this product in mainland China (Hong Kong, Macao and Taiwan Excluded) is subject to the terms and conditions of the Maintenance Guarantee Card.

For users in Europe and Russia, full details of warranty provided can be found in [www.viewsoniceurope.com](http://www.viewsoniceurope.com) under Support/Warranty Information.

# **Mexico Limited Warranty**

## **ViewSonic® Display**

### **What the warranty covers:**

ViewSonic warrants its products to be free from defects in material and workmanship, under normal use, during the warranty period. If a product proves to be defective in material or workmanship during the warranty period, ViewSonic will, at its sole option, repair or replace the product with a like product. Replacement product or parts may include remanufactured or refurbished parts or components & accessories.

### **How long the warranty is effective:**

ViewSonic LCD displays are warranted for between 1 and 3 years, depending on your country of purchase, for all parts including the light source and for all labour from the date of the first consumer purchase

### **Who the warranty protects:**

This warranty is valid only for the first consumer purchaser.

## **What the warranty does not cover:**

1. Any product on which the serial number has been defaced, modified or removed.
2. Damage, deterioration or malfunction resulting from:
  - a. Accident, misuse, neglect, fire, water, lightning, or other acts of nature, unauthorized product modification, unauthorized attempted repair, or failure to follow instructions supplied with the product.
  - b. Causes external to the product, such as electrical power fluctuations or failure.
  - c. Use of supplies or parts not meeting ViewSonic's specifications.
  - d. Normal wear and tear.
  - e. Any other cause which does not relate to a product defect.
3. Any product exhibiting a condition commonly known as "image burn-in" which results when a static image is displayed on the product for an extended period of time.
4. Removal, installation, insurance, and set-up service charges.

## How to get service:

For information about receiving service under warranty, contact ViewSonic Customer Support (Please refer to the attached Customer Support page). You will need to provide your product's serial number, so please record the product information in the space provided below on your purchase for your future use. Please retain your receipt of proof of purchase to support your warranty claim.

For Your Records

Product Name: \_\_\_\_\_ Model Number: \_\_\_\_\_

Document Number: \_\_\_\_\_ Serial Number: \_\_\_\_\_

Purchase Date: \_\_\_\_\_ Extended Warranty Purchase? \_\_ (Y/N)

If so, what date does warranty expire? \_\_\_\_\_

1. To obtain warranty service, you will be required to provide (a) the original dated sales slip, (b) your name, (c) your address, (d) a description of the problem, and (e) the serial number of the product.
2. Take or ship the product in the original container packaging to an authorized ViewSonic service center.
3. Round trip transportation costs for in-warranty products will be paid by ViewSonic.

**Limitation of implied warranties:**

There are no warranties, express or implied, which extend beyond the description contained herein including the implied warranty of merchantability and fitness for a particular purpose.

**Exclusion of damages:**

ViewSonic's liability is limited to the cost of repair or replacement of the product. ViewSonic shall not be liable for:

1. Damage to other property caused by any defects in the product, damages based upon inconvenience, loss of use of the product, loss of time, loss of profits, loss of business opportunity, loss of goodwill, interference with business relationships, or other commercial loss, even if advised of the possibility of such damages.
2. Any other damages, whether incidental, consequential or otherwise.
3. Any claim against the customer by any other party.
4. Repair or attempted repair by anyone not authorized by ViewSonic.

<b>Contact Information for Sales &amp; Authorized Service (Centro Autorizado de Servicio) within Mexico:</b>	
<b>Name, address, of manufacturer and importers:</b> México, Av. de la Palma #8 Piso 2 Despacho 203, Corporativo Interpalmas, Col. San Fernando Huixquilucan, Estado de México Tel: (55) 3605-1099 <a href="http://www.viewsonic.com/la/soporte/index.htm">http://www.viewsonic.com/la/soporte/index.htm</a>	
<b>NÚMERO GRATIS DE ASISTENCIA TÉCNICA PARA TODO MÉXICO: 001.866.823.2004</b>	
<b>Hermosillo:</b> Distribuciones y Servicios Computacionales SA de CV. Calle Juarez 284 local 2 Col. Bugambilias C.P: 83140 Tel: 01-66-22-14-9005 E-Mail: <a href="mailto:disc2@hmo.megared.net.mx">disc2@hmo.megared.net.mx</a>	<b>Villahermosa:</b> Compumantenimietnos Garantizados, S.A. de C.V. AV. GREGORIO MENDEZ #1504 COL, FLORIDA C.P. 86040 Tel: 01 (993) 3 52 00 47 / 3522074 / 3 52 20 09 E-Mail: <a href="mailto:compumantenimientos@prodigy.net.mx">compumantenimientos@prodigy.net.mx</a>
<b>Puebla, Pue. (Matriz):</b> RENTA Y DATOS, S.A. DE C.V. Domicilio: 29 SUR 721 COL. LA PAZ 72160 PUEBLA, PUE. Tel: 01(52).222.891.55.77 CON 10 LINEAS E-Mail: <a href="mailto:datos@puebla.megared.net.mx">datos@puebla.megared.net.mx</a>	<b>Veracruz, Ver.:</b> CONEXION Y DESARROLLO, S.A DE C.V. Av. Americas # 419 ENTRE PINZÓN Y ALVARADO Fracc. Reforma C.P. 91919 Tel: 01-22-91-00-31-67 E-Mail: <a href="mailto:gacosta@qplus.com.mx">gacosta@qplus.com.mx</a>
<b>Chihuahua</b> Soluciones Globales en Computación C. Magisterio # 3321 Col. Magisterial Chihuahua, Chih. Tel: 4136954 E-Mail: <a href="mailto:Cefeo@soluglobales.com">Cefeo@soluglobales.com</a>	<b>Cuernavaca</b> Compusupport de Cuernavaca SA de CV Francisco Leyva # 178 Col. Miguel Hidalgo C.P. 62040, Cuernavaca Morelos Tel: 01 777 3180579 / 01 777 3124014 E-Mail: <a href="mailto:aquevedo@compusupportcva.com">aquevedo@compusupportcva.com</a>
<b>Distrito Federal:</b> QPLUS, S.A. de C.V. Av. Coyoacán 931 Col. Del Valle 03100, México, D.F. Tel: 01(52)55-50-00-27-35 E-Mail : <a href="mailto:gacosta@qplus.com.mx">gacosta@qplus.com.mx</a>	<b>Guadalajara, Jal.:</b> SERVICRECE, S.A. de C.V. Av. Niños Héroe # 2281 Col. Arcos Sur, Sector Juárez 44170, Guadalajara, Jalisco Tel: 01(52)33-36-15-15-43 E-Mail: <a href="mailto:mmiranda@servicrece.com">mmiranda@servicrece.com</a>
<b>Guerrero Acapulco</b> GS Computación (Grupo Sesicomp) Progreso #6-A, Colo Centro 39300 Acapulco, Guerrero Tel: 744-48-32627	<b>Monterrey:</b> Global Product Services Mar Caribe # 1987, Esquina con Golfo Pérsico Fracc. Bernardo Reyes, CP 64280 Monterrey N.L. México Tel: 8129-5103 E-Mail: <a href="mailto:aydeem@gps1.com.mx">aydeem@gps1.com.mx</a>
<b>MERIDA:</b> ELECTROSER Av Reforma No. 403Gx39 y 41 Mérida, Yucatán, México CP97000 Tel: (52) 999-925-1916 E-Mail: <a href="mailto:rrrb@sureste.com">rrrb@sureste.com</a>	<b>Oaxaca, Oax.:</b> CENTRO DE DISTRIBUCION Y SERVICIO, S.A. de C.V. Murguía # 708 P.A., Col. Centro, 68000, Oaxaca Tel: 01(52)95-15-15-22-22 Fax: 01(52)95-15-13-67-00 E-Mail: <a href="mailto:gpotai2001@hotmail.com">gpotai2001@hotmail.com</a>
<b>Tijuana:</b> STD Av Ferrocarril Sonora #3780 L-C Col 20 de Noviembre Tijuana, Mexico	<b>FOR USA SUPPORT:</b> ViewSonic Corporation 381 Brea Canyon Road, Walnut, CA. 91789 USA Tel: 800-688-6688 (English); 866-323-8056 (Spanish); E-Mail: <a href="http://www.viewsonic.com">http://www.viewsonic.com</a>

LCD Mexico Warranty Term Template In UG

VSC\_TEMP\_2008



ViewSonic®