



HELDER®



H-UPM-100

Universal
Projector Mount

Thank you for choosing Helder

The Helder Universal Projector Mount provides an easy solution for attaching your projector to a flat or slanted ceiling with multiple angle adjustments. Preassembled parts make the installation process quick and simple. This mount offers 360° placement with adjustable sizing to fit most projectors, including portable units. Mount your projector at home, the conference room, or your classroom for overhead and unobstructed video viewing.

If you have safety concerns about installing this product, contact a qualified professional or installation contractor. If this product is missing hardware or there are defective parts, call Customer Service at 212-594-2353.



Safety Warnings

When installing this product, be sure to refer to the assembly instructions detailed in this manual; failure to abide by the assembly instructions may void the product's warranty.

Do not use this product for any projector other than what it is intended for; the exact specifications, size parameters, and weight limits are found both on the product box and in the instruction manual.

This product has been designed specifically for mounting directly on wooden joists or concrete ceilings; depending on the ceiling type and material, the use of additional appropriate mounting hardware and/or accessories such as heavy-duty anchors may be required.

The supplied mounting hardware is not intended for use on metal joists or cinder block ceilings and may not be appropriate for old or weak ceilings; it is best to consult with a qualified professional installer to determine whether your ceiling can support this mount.

Do not mount this product on structures that may be affected by vibrations or noticeable impacts; do not install near a heater, fireplace, or any other source of direct heat energy.

It is recommended that at least 2 people perform the installation process to prevent injury from mishandling or dropping the product and/or projector.

This product may contain small parts which can pose a choking hazard; keep out of reach of children and pets.

Excessive exposure to liquids may damage the finish of this product; when cleaning this product, use only a mild detergent solution, and quickly wipe dry with a soft cloth.

Helder takes no responsibility for any product damage or personal injury resulting from mishandling, incorrect mounting, faulty assembly, or improper use of this product.

All images are for illustrative purposes only.

Parts List

Required Tools



Drill

Stud finder



Wood drill bit
3/16 in. (4.5 mm)



Concrete drill bit
3/8 in. (10 mm)



Phillips
screwdriver



Hammer



Pencil



A. (x1)



B. (x1)



m-A (x4)

M3 x 8 mm



m-B (x4)

M4 x 10 mm



m-C (x4)

M5 x 10 mm



m-D (x4)

M6 x 10 mm



m-E (x4)

D3



m-F (x4)

D4



m-G (x4)

D5



m-H (x4)

D6



m-I (x2)

M5 x 12 mm



m-J (x2)

D5



m-K (x2)

D5



m-L (x1)

1/4-20 x 3/8



m-M (x1)

D6



m-N (x1)

Hex Key



m-O (x1)

Wrench



W-A (x4)



W-B (x4)



W-C (x4)



Cable Management

Determine the placement of the projector on your ceiling as well as how to run the power and A/V cables to your device. Cables can run down through the mount or from the side as shown.

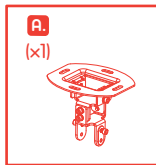

Side Through

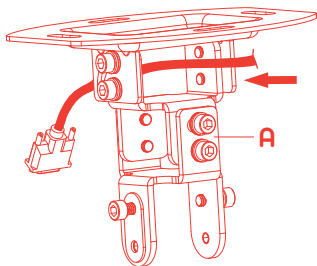

Down Through

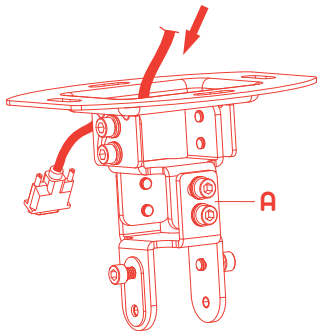

Attaching the Mount to Wooden Joists

Wooden joists run inside the ceiling, 16 inches apart, behind the drywall or plaster.

Important! The mount must be attached to a wooden joist, or it could fall out and damage your display or cause personal harm.

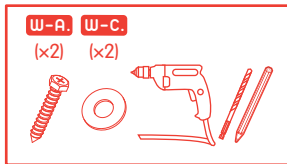

Flat or Slanted Ceiling

Mount your projector into a flat or slanted ceiling by adjusting the mount's pitch. This will depend on the size of the projector.

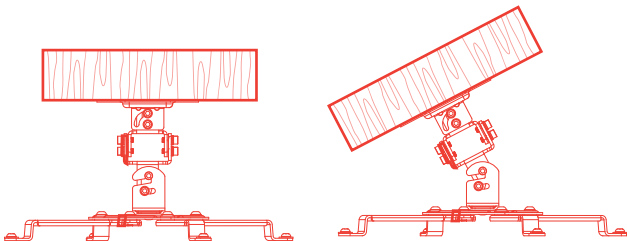

Attaching the Mount to Wooden Joists (cont.)

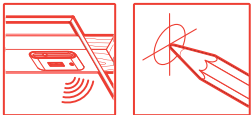

1. Use a stud finder to locate and mark the edges of the wooden joist for mounting and predrill the two mounting holes.

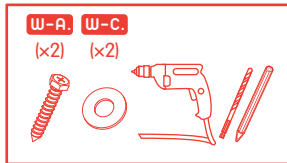
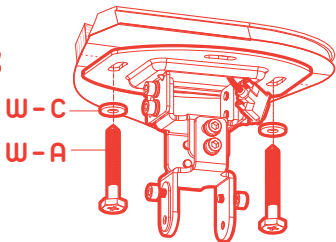
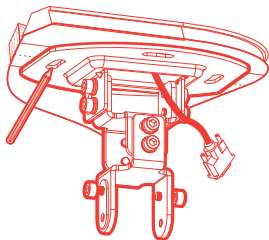

2. Secure the mount with the screws and washers.

Attaching the Mount to Concrete

Warning! Make sure the concrete ceiling is solid and at least 8 inches (20 cm) thick.

If the concrete exhibits cracks or other defects, this may result in failure of the anchors and serious personal injury or damage to your display.

Important: Do not drill mounting holes into mortar, such as between bricks or stones. Drill and install only into solid concrete or stone surfaces.

Flat or Slanted Ceiling

Mount your projector into a flat or slanted ceiling by adjusting the mount's pitch. This will depend on the size of the projector.

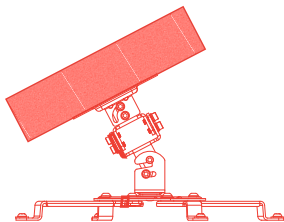
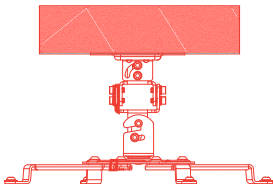
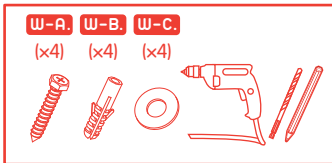

Attaching the Mount to Concrete (cont.)

W-A.

(x4)

W-B.

(x4)

W-C.

(x4)



1. Mark the location for mounting and predrill the four mounting holes.

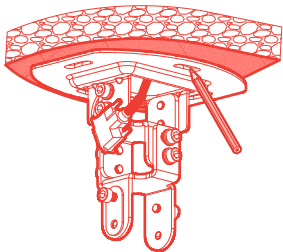

2. Insert the anchors and use a hammer to tap them flush with the ceiling. Secure the mount with the screws and washers.

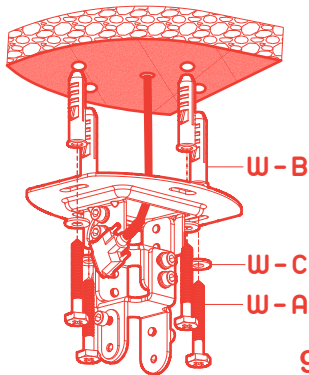

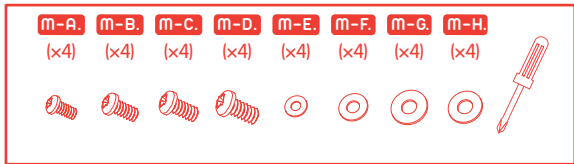

Attaching the Projector

Customize the mount's arms to fit your projector's mounting holes.

There is a max arm span of 12.5 inches, and you can use three or four arms with different configurations.

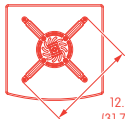
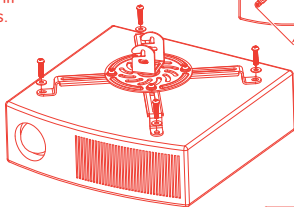
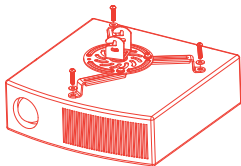

12.5 in.
(31.75 cm)

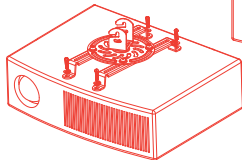

Note: Remove one of the arms for a three-arm configuration.

Attaching a Portable Projector

You can attach a portable projector with the 1/4-20 screw.

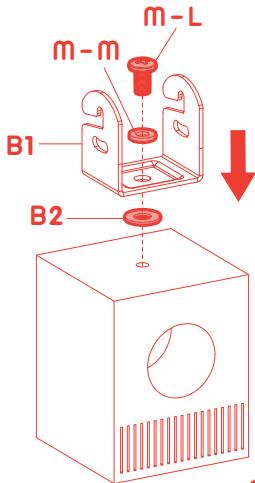
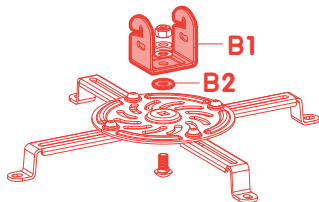
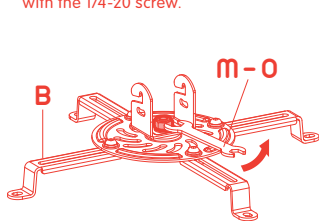
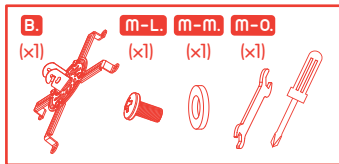

Mounting the Projector



m-l.	m-j.	m-k.	m-n.
(x2)	(x2)	(x2)	(x1)

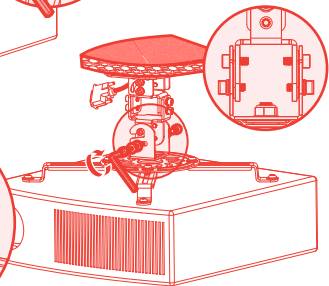
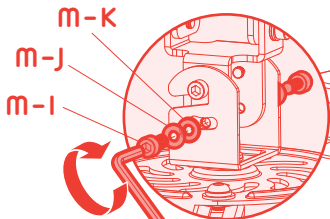
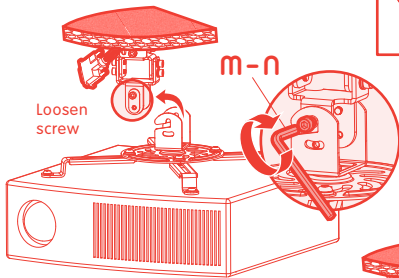

Adjusting the Projector

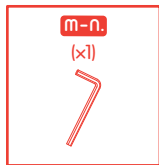
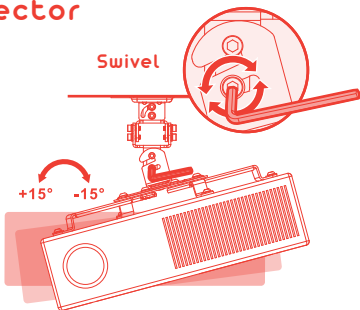

Rotation

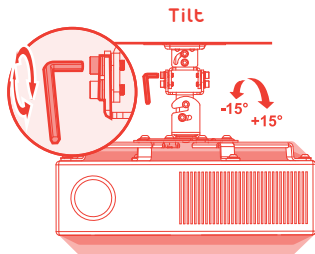
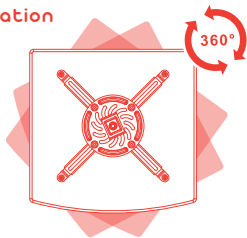

Product Specifications

Max Weight Capacity:

29.7 lb. (13.5 kg)

Mounting Hole Span:

5.25 to 12.5 in.
(13.3 to 31.75 cm)

Mounting Depth:

5.7 in. (14.6 cm)

Material:

Steel

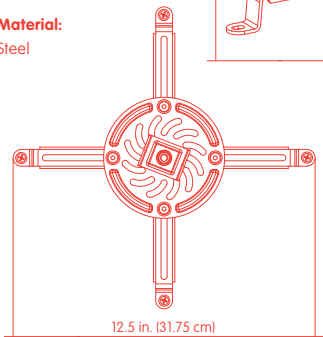
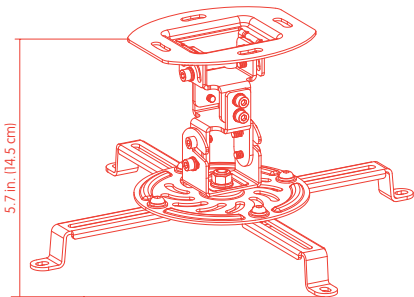

One-Year Limited Warranty

This Helder product is warranted to the original purchaser to be free from defects in materials and workmanship under normal consumer use for a period of one (1) year from the original purchase date or thirty (30) days after replacement, whichever occurs later. The warranty provider's responsibility with respect to this limited warranty shall be limited solely to repair or replacement, at the provider's discretion, of any product that fails during normal use of this product in its intended manner and in its intended environment. The inoperability of the product or part(s) shall be determined by the warranty provider. If the product has been discontinued, the warranty provider reserves the right to replace it with a model of equivalent quality and function.

This warranty does not cover damage or defect caused by misuse, neglect, accident, alteration, abuse, improper installation or maintenance. EXCEPT AS PROVIDED HEREIN, THE WARRANTY PROVIDER MAKES NEITHER ANY EXPRESS WARRANTIES NOR ANY IMPLIED WARRANTIES, INCLUDING BUT NOT LIMITED TO ANY IMPLIED WARRANTY OF MERCHANTABILITY OR FITNESS FOR A PARTICULAR PURPOSE. This warranty provides you with specific legal rights, and you may also have additional rights that vary from state to state.

To obtain warranty coverage, contact the Helder Customer Service Department to obtain a return merchandise authorization ("RMA") number, and return the defective product to Helder along with the RMA number and proof of purchase. Shipment of the defective product is at the purchaser's own risk and expense. For more information or to arrange service, call Customer Service at 212-594-2353.

Product warranty provided by the
Gradus Group.

www.gradusgroup.com

HELDER

Helder is a registered trademark of
the Gradus Group.

© 2025 Gradus Group LLC.

All Rights Reserved.

GG2

