

# marantz

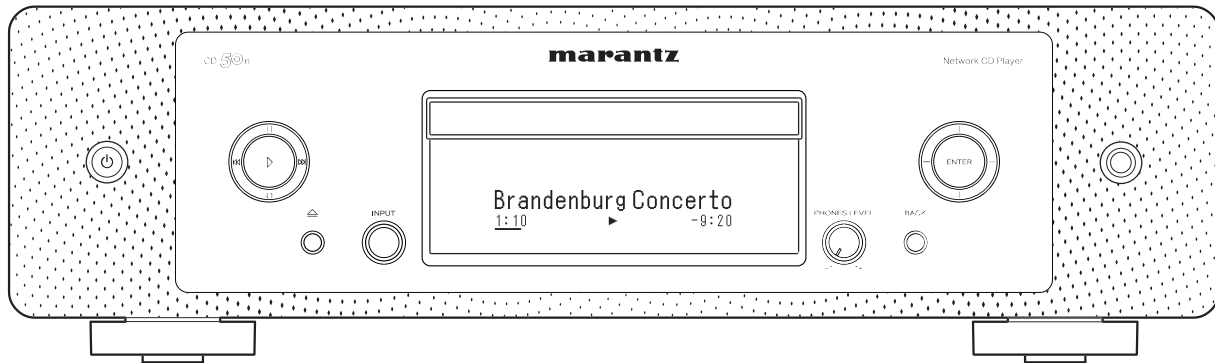

CD50n | Network CD Player

Owner's Manual

<b>Accessories</b>	7
Inserting the batteries	8
Operating range of the remote control unit	8
<b>Part names and functions</b>	9
Front panel	9
Rear panel	12
Remote control unit	15

## Connections

<b>Connecting an amplifier</b>	<b>21</b>
Connecting a Marantz amplifier	22
<b>Connecting a TV</b>	<b>27</b>
Connecting this unit to the HDMI ARC terminal on a TV	27
Connecting this unit to the Optical or Coaxial terminal on a TV	29
<b>Connecting to a device with digital audio input connectors</b>	<b>31</b>
<b>Connecting to a device with digital audio output connectors</b>	<b>32</b>
<b>Connecting a PC or Mac</b>	<b>33</b>
<b>Connecting a USB flash drive to the USB port</b>	<b>34</b>
<b>Connecting to a home network (LAN)</b>	<b>35</b>
Wired LAN	35
Wireless LAN	36
<b>Connecting an external control device</b>	<b>37</b>
FLASHER IN jack	37
REMOTE CONTROL connectors	38
<b>Connecting the power cord</b>	<b>40</b>



## Playback

<b>Basic operation</b>	<b>42</b>
Turning the power on	42
Switching the power to standby	42
Selecting the input source	43
<b>Listening to Internet Radio</b>	<b>44</b>
Listening to Internet Radio	45
<b>Playing back files stored on PC or NAS</b>	<b>46</b>
Playing back files stored on PC or NAS	47
<b>Playing a USB flash drive</b>	<b>49</b>
Playing files stored on USB flash drives	50
<b>Listening to music on a Bluetooth device</b>	<b>52</b>
Listening to music on a Bluetooth device	53
Pairing with other Bluetooth devices	54
Reconnecting to this unit from a Bluetooth device	55
<b>Listening to audio on Bluetooth headphones</b>	<b>56</b>
Listening to audio on Bluetooth headphones	57
Reconnecting to a Bluetooth headphones	58
Disconnecting Bluetooth headphones	58

<b>Getting the HEOS app</b>	<b>59</b>
Setting up the HEOS app for the first time with a HEOS Built-in device	60
Adding the registration of HEOS Built-in devices in the HEOS app	61
HEOS Account	62
Playing from streaming music services	63
Listening to the same music in multiple rooms	66
<b>Playing CDs</b>	<b>70</b>
Playing CDs	70
Playing tracks in a specific order (Program playback)	72
<b>Playing DATA CDs</b>	<b>73</b>
Playing files	74



<b>Playing digital input</b>	<b>76</b>
Connecting and playing back from a TV or digital device (HDMI/Coaxial/Optical)	76
Connecting and playing back from a computer (USB-DAC)	78
<b>AirPlay function</b>	<b>87</b>
Playing songs from your iPhone, iPod touch or iPad	88
Playing iTunes music with this unit	88
Play a song from your iPhone, iPod touch or iPad on multiple synced devices (AirPlay 2)	89
<b>Spotify Connect function</b>	<b>90</b>
Playing Spotify music with this unit	90
<b>Convenience functions</b>	<b>91</b>
Playing back HEOS Favorites	92
Adding to HEOS Favorites	92
Deleting a HEOS Favorites	93
Switching the display's brightness	93
Using the sleep timer	94

## Settings

<b>Menu map</b>	<b>95</b>
Menu operation	97
<b>Inputting characters</b>	<b>98</b>
Using the number buttons	98
Using the cursor buttons	99
<b>Audio</b>	<b>101</b>
Filter	101
Lock Range	101
Line Out Level	102
Variable Out	104
Volume Limit	105
Digital Out	105
H/P Amplifier Gain	106
<b>TV</b>	<b>107</b>
TV Input	107
HDMI Power Off Control	108
<b>General</b>	<b>109</b>
Language	109
Auto-Standby	109
Power Sync	110
Information	110
Reset	110



<b>Network</b>	<b>111</b>
Network Information	111
Network & USB-A	111
Wi-Fi	111
Bluetooth	112
Network Control	113
AirPlay Setup	113
<b>Connecting to the network by using the WPS button on the router</b>	<b>114</b>
<b>Switching the function of the volume buttons on the remote control</b>	<b>115</b>
Setting the remote control operation mode to network CD player operation mode	116
Setting the remote control operation mode to amplifier operation mode	116

## Tips

<b>Tips</b>	<b>118</b>
<b>Troubleshooting</b>	<b>120</b>
Power does not turn on / Power is turned off	121
Operations cannot be performed through the remote control unit	122
Display on this unit shows nothing	122
No sound comes out	123
Sound is interrupted or noise occurs	124
Desired sound does not come out	125
AirPlay cannot be played back	126
USB flash drives cannot be played back	127
Bluetooth cannot be played back	128



The Internet radio cannot be played back	130
Music files on PC or NAS cannot be played back (Music server)	131
Various online services cannot be played	132
Cannot connect to a wireless LAN network	132
Cannot playback Discs	133
Music files on PC or Mac cannot be played back (USB-DAC)	134
Audio from digital devices cannot be played back (HDMI ARC/Coaxial/Optical)	135
The input source switches to “HDMI”, “Optical” or “Coaxial”	135
The HDMI control function does not work	135
Update/upgrade error messages	136
<b>Resetting network settings</b>	<b>137</b>
<b>Factory Restore</b>	<b>138</b>

## Appendix

<b>Playing back Discs</b>	<b>139</b>
Files	139
<b>Playback order of music files</b>	<b>140</b>
<b>About discs and files</b>	<b>140</b>
<b>Playing back a USB flash drives</b>	<b>141</b>
<b>Cautions on using media</b>	<b>143</b>
Inserting a disc	143
How to handle media	144
Cleaning discs	144
<b>Digital input</b>	<b>145</b>
<b>Playing back a Bluetooth device</b>	<b>145</b>
<b>Playing back files stored on a PC and NAS</b>	<b>146</b>
<b>Playing back Internet Radio</b>	<b>147</b>
<b>Last function memory</b>	<b>147</b>
<b>About HDMI</b>	<b>148</b>
<b>Explanation of terms</b>	<b>149</b>
<b>Trademark information</b>	<b>153</b>
<b>Specifications</b>	<b>155</b>
<b>Index</b>	<b>160</b>







Thank you for purchasing this Marantz product.

To ensure proper operation, please read this owner's manual carefully before using the product.

After reading this manual, be sure to keep it for future reference.

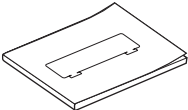
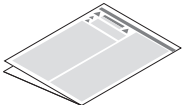
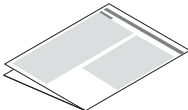
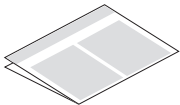
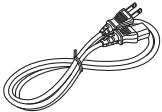
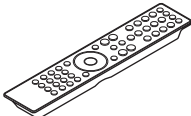
## Accessories

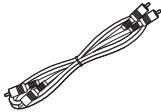
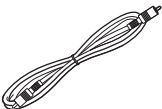
Check that the following parts are included with the product.

 <p>Quick Start Guide</p>	 <p>Safety Instructions</p>	 <p>Notes on radio</p>	 <p>Warranty (for North America model only)</p>
 <p>Power cord</p>	 <p>Remote control unit (RC003PMND)</p>	 <p>2x R03/AAA batteries</p>	 <p>Audio cable</p>
 <p>Remote connector cable</p>	 <p>External antennas for Bluetooth/wireless connectivity</p>		



## Inserting the batteries

- 1 Remove the rear lid in the direction of the arrow and remove it.

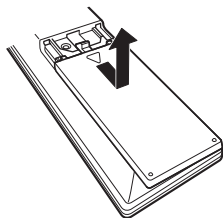

- 2 Insert two batteries correctly into the battery compartment as indicated.

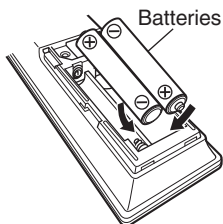

- 3 Put the rear lid back on.

### NOTE

- To prevent damage or leakage of battery fluid:
  - Do not use a new battery together with an old one.
  - Do not use two different types of batteries.
- Remove the batteries from the remote control unit if it will not be in use for long periods.
- If the battery fluid should leak, carefully wipe the fluid off the inside of the battery compartment and insert new batteries.

## Operating range of the remote control unit

Point the remote control unit at the remote sensor when operating it.

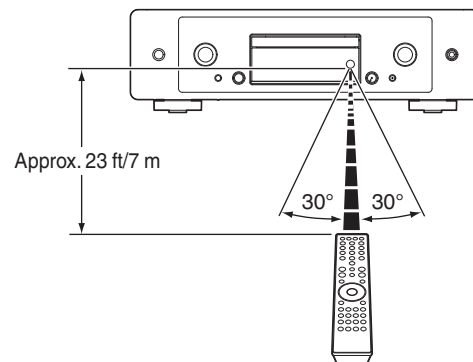

## Part names and functions

### Front panel

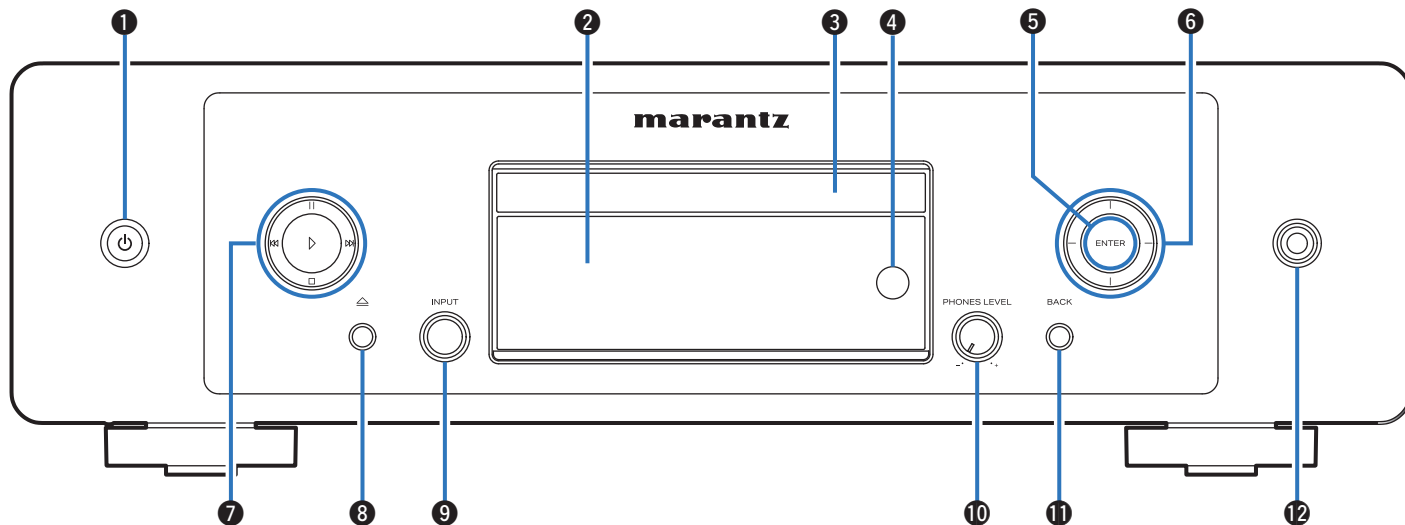

For details, see the next page.



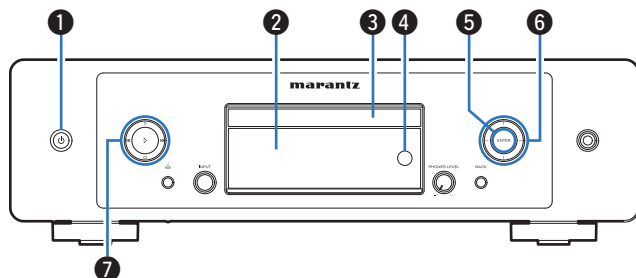

### 1 Power (⏻) button

This turns the power on/off (standby). (👉 p. 42)

### 2 Display

This displays various pieces of information.

### 3 Disc tray

Used to insert a disc. (👉 p. 143)

### 4 Remote control sensor

This receives signals from the remote control unit. (👉 p. 8)

### 5 ENTER button

Plays back and pauses tracks, and enters the selected content.

### 6 Cursor buttons

These select items.

### 7 System buttons

These perform playback related operations.

- Play button (▶)
- If pressed while paused or stopped, resumes playback from the last track played.
- Pause button (⏸)
- Press this button to pause during playback.
- Forward-skip button (⏭)
- Press this button during playback to play the next track.
- Reverse-skip button (⏮)
- Press this button during playback to restart the current track or play the previous track.
- Stop button (⏹)
- Press this button to stop during playback.



- Depending on the input source and online service, the operation cannot be performed.

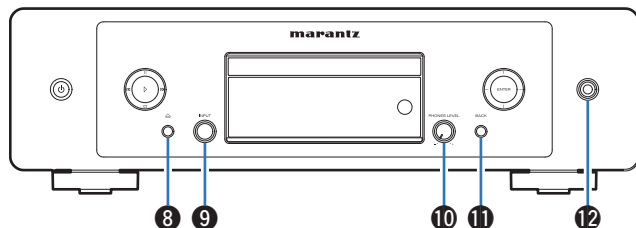

**8 Disc tray open/close button (▲)**

Opens and closes the disc tray. (☞ p. 70)

**9 INPUT selector knob**

This selects the input source.

**10 Headphone volume control knob (PHONES LEVEL)**

Adjusts the headphone volume.

**11 BACK button**

Returns to the previous item.

**12 Headphones jack**

Used to connect headphones.

**NOTE**

- To prevent hearing loss, do not raise the volume level excessively when using headphones.



## Rear panel

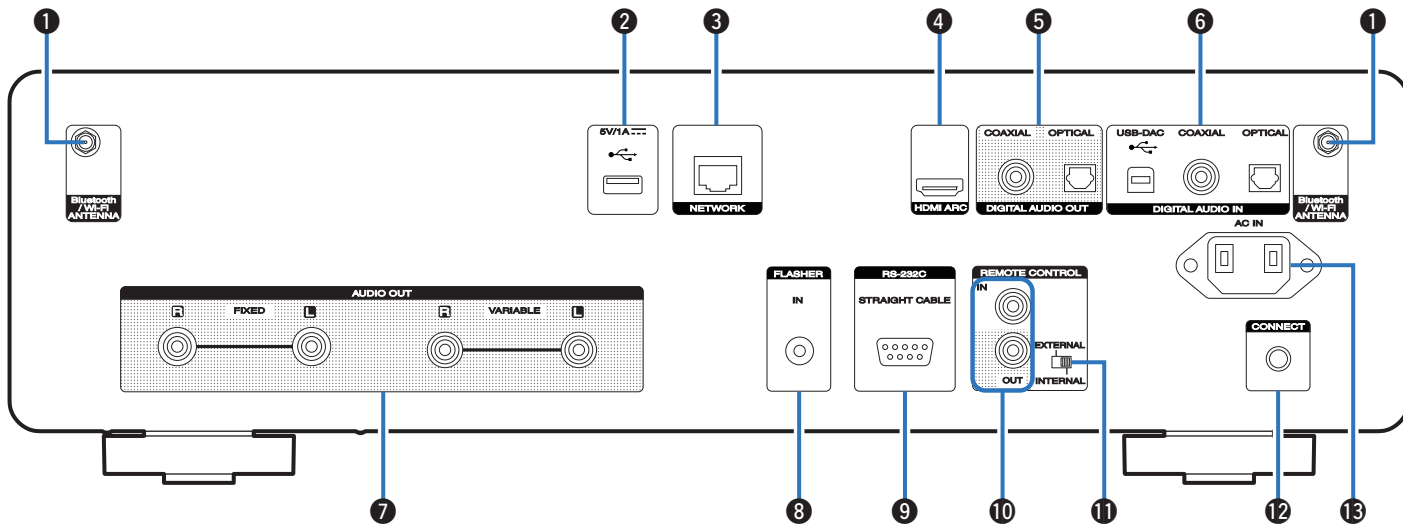

For details, see the next page.



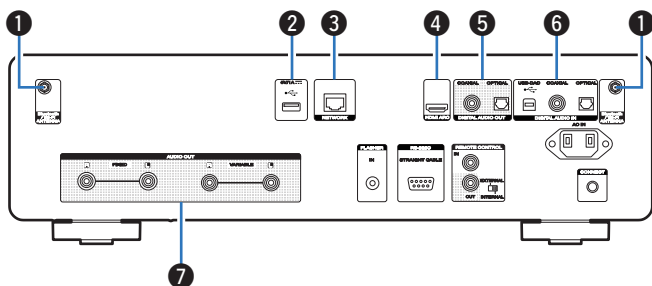

### 1 Bluetooth/wireless LAN antenna connectors

Used to connect the included external antennas for Bluetooth/wireless connectivity when connecting to a network via wireless LAN, or when connecting to a handheld device via Bluetooth. (☞ p. 36)

- ① Place the external antennas for Bluetooth/wireless connectivity evenly over the screw terminal of rear.
- ② Turn clockwise until the antennas is fully connected.
- ③ Rotate the antenna upwards for best reception.

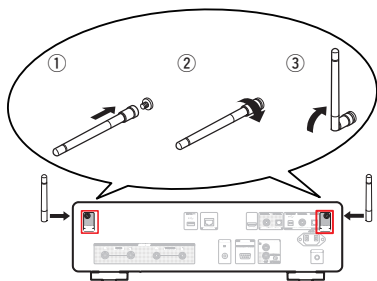

### 2 USB port (☞)

This is used to connect USB storages (such as USB flash drives). (☞ p. 34)

### 3 NETWORK connector

Used to connect to a LAN cable when connecting to a wired LAN network. (☞ p. 35)

### 4 HDMI connector (HDMI ARC)

Used to connect an ARC function-compatible TV. (☞ p. 27)

### 5 DIGITAL AUDIO OUT connectors

Used to connect an amplifier or D/A converter that has a digital input connectors. (☞ p. 31)

### 6 DIGITAL AUDIO IN connectors

- Used to connect a TV with an optical or coaxial digital terminal. (☞ p. 29)
- Used to connect devices equipped with digital audio output connectors. (☞ p. 32)
- Used to connect a computer. (☞ p. 33)

### 7 AUDIO OUT connectors

Used to connect devices equipped with analog audio inputs connectors or an external power amplifier. (☞ p. 21)



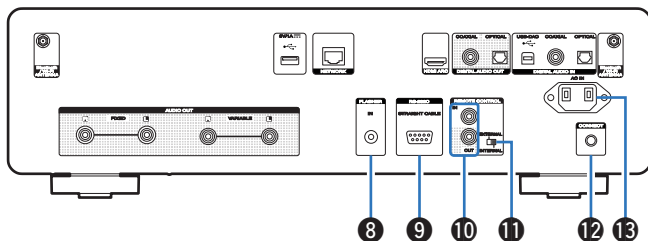

### 8 FLASHER IN jack

Used to connect a control box, etc. (☞ p. 37)

### 9 RS-232C connector

Used to connect home automation controller devices fitted with RS-232C connectors. Consult the owner's manual of the home automation controller for more information about serial control of this unit.

Perform the operation below beforehand.

- ① Turn on the power of this unit.
- ② Turn off the power of this unit from the external controller.
- ③ Check that the unit is in the standby mode.

### 10 REMOTE CONTROL connectors

Used to connect to a Marantz audio device that is compatible with the remote control function. (☞ p. 38)

### 11 EXTERNAL/INTERNAL switch

Turn this switch to "EXTERNAL" to operate the unit by pointing the remote control at the amplifier connected to this unit using the remote control connection. (☞ p. 38)

### 12 CONNECT button

Used for Wi-Fi setup. (☞ p. 114)

### 13 AC inlet (AC IN)

Used to connect the power cord. (☞ p. 40)



## Remote control unit

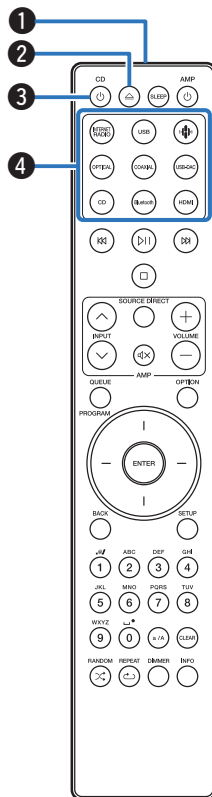

The remote control provided with this unit can control a Marantz amplifier.

- “Amplifier operations” (👉 p. 19)

### ■ Operating this unit

#### 1 Remote control signal transmitter

This transmits signals from the remote control unit. (👉 p. 8)

#### 2 Disc tray open/close button (△)

Opens and closes the disc tray. (👉 p. 70)

#### 3 Power (CD) button

This turns the power on/off (standby). (👉 p. 42)

#### 4 Input source select buttons

These select the input source. (👉 p. 43)



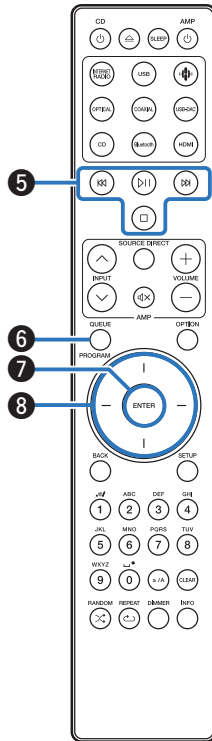

## 5 System buttons

These perform playback related operations.

- **Play/Pause button** (⏮)
 

Press this button to pause during playback. If pressed while paused or stopped, resumes playback from the last track played.
- **Forward-skip button** (⏭)
 

Press this button during playback to play the next track.
- **Reverse-skip button** (⏪)
 

Press this button during playback to restart the current track or play the previous track.
- **Stop button** (⏹)
 

Press this button to stop during playback.



- Depending on the input source and online service, the operation cannot be performed.

## 6 QUEUE button

This displays the queue.

- “Listening to Internet Radio” (👉 p. 44)
- “Playing back files stored on PC or NAS” (👉 p. 46)
- “Playing a USB flash drive” (👉 p. 49)

## PROGRAM button

This sets program playback. (👉 p. 72)

## 7 ENTER button

This determines the selection.

## 8 Cursor buttons

These select items.



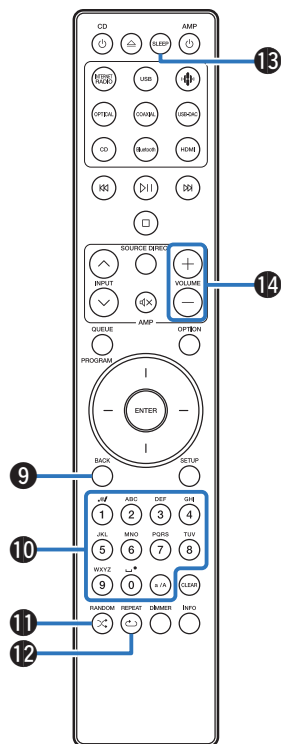

### 9 BACK button

Returns to the previous item.

### 10 Number/letter buttons (0 – 9, a/A)

These enter letters or numbers into the unit. (👉 p. 98)

### 11 RANDOM button (X)

Switches the random playback.

### 12 REPEAT button (↺)

Switches the repeat playback.

### 13 SLEEP button

This sets the sleep timer. (👉 p. 94)

### 14 VOLUME buttons (+/-)

These adjust the volume of the audio signal output from the analog audio output terminals (VARIABLE) of this unit. This function is enabled when the volume control mode of the remote control is network CD player control mode. (👉 p. 115)



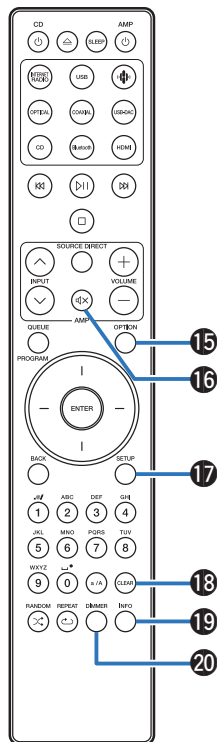

### 15 OPTION button

- This displays the option menu on the display.



- An option menu is not displayed for some input sources.

- This switches the playback range on a data CD. (👉 p. 75)

### 16 MUTE button (M)

This mutes the audio signal output from the analog audio output terminals (VARIABLE) of this unit. This function is enabled when the volume control mode of the remote control is network CD player control mode. (👉 p. 115)

### 17 SETUP button

The setting menu is displayed on the display. (👉 p. 97)

### 18 CLEAR button

This cancels the settings.

### 19 Information button (INFO)

This switches the track information shown in the display during playback.

### 20 DIMMER button

Adjust the display brightness of this unit. (👉 p. 93)



## ■ Amplifier operations

A Marantz amplifier can be operated.

- ① INPUT buttons (^∨)
- ② MUTE button (M)
- ③ Power (AMP ⏻) button
- ④ SOURCE DIRECT button
- ⑤ VOLUME buttons (+-)



- The remote control may not operate some products.
- ② and ⑤ can be operated when the remote control operation mode is set to amplifier operation mode (factory default setting). (👉 p. 115)

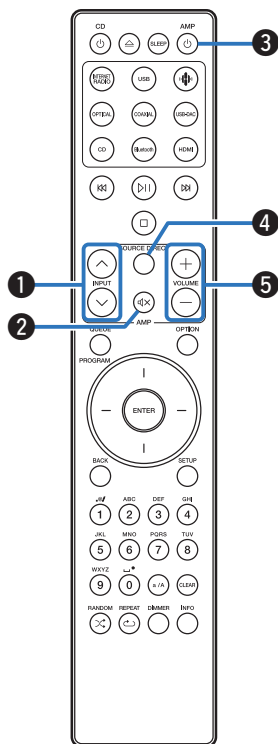

## ■ Contents









Connecting an amplifier	21
Connecting a TV	27
Connecting to a device with digital audio input connectors	31
Connecting to a device with digital audio output connectors	32
Connecting a PC or Mac	33
Connecting a USB flash drive to the USB port	34
Connecting to a home network (LAN)	35
Connecting an external control device	37
Connecting the power cord	40

### NOTE

- Do not plug in the power cord until all connections have been completed.
- Do not bundle power cords with connection cables. Doing so can result in humming or noise.

## ■ Cables used for connections

Provide necessary cables according to the devices you want to connect.

Audio cable (included)	
Remote connector cable (included)	
HDMI cable (not included)	
Optical cable (not included)	
Coaxial digital cable (not included)	
USB cable (not included)	
LAN cable (not included)	
Monaural mini-plug cable (not included)	



## Connecting an amplifier

In addition to the normal analog audio output connectors (FIXED) this unit has analog audio output connectors (VARIABLE) that allow you to adjust the volume of the audio signal output from this unit. Connect the power amplifier to the analog audio output connectors (VARIABLE) and press the VOLUME  $\pm$  buttons on the remote control to adjust the volume of the audio signal output from this unit.

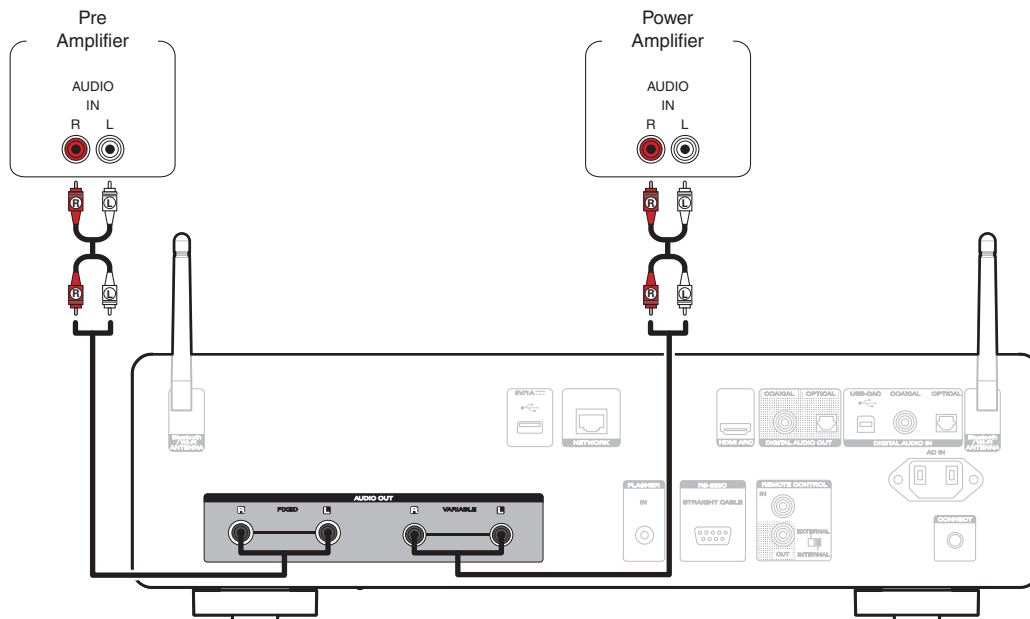

### NOTE

- Do not connect a power amplifier to the analog audio output connectors (FIXED). Connecting a power amplifier may cause damage to the speakers.
- In the settings menu, set the audio output terminal for "Line Out Level" to "Variable" or "Fixed". (☞ p. 102)
- To adjust the volume of the audio signal output from the analog audio output connectors (VARIABLE) of this unit using the remote control, set the remote control operation mode of the volume buttons to network CD player operation mode. (☞ p. 115)
- While using HDMI ARC for TV connection it is highly recommended for the best volume control experience to use the variable output from this unit to connect to the amplifier.



## Connecting a Marantz amplifier

When the unit is connected in combination with a Marantz amplifier, the amplifier can be controlled from the unit. (👉 p. 38)



- Some operations may not be possible on some Marantz amplifiers.
- Use the remote connection cable provided with the unit to connect the REMOTE CONTROL IN terminal of the unit and the REMOTE CONTROL OUT terminal of the amplifier. (👉 p. 38)



## ■ Connect to the CD input terminal of the amplifier

Connect the analog audio output terminal (FIXED) of the unit to the CD input terminal of the amplifier. The volume of the amplifier can be adjusted by pressing the VOLUME + and – buttons on the remote control.

If you have an HDMI ARC connection between the unit and the TV, we recommend that you connect the amplifier to the analog audio output terminal (VARIABLE) of the unit for comfortable volume adjustment. (👉 p. 24)

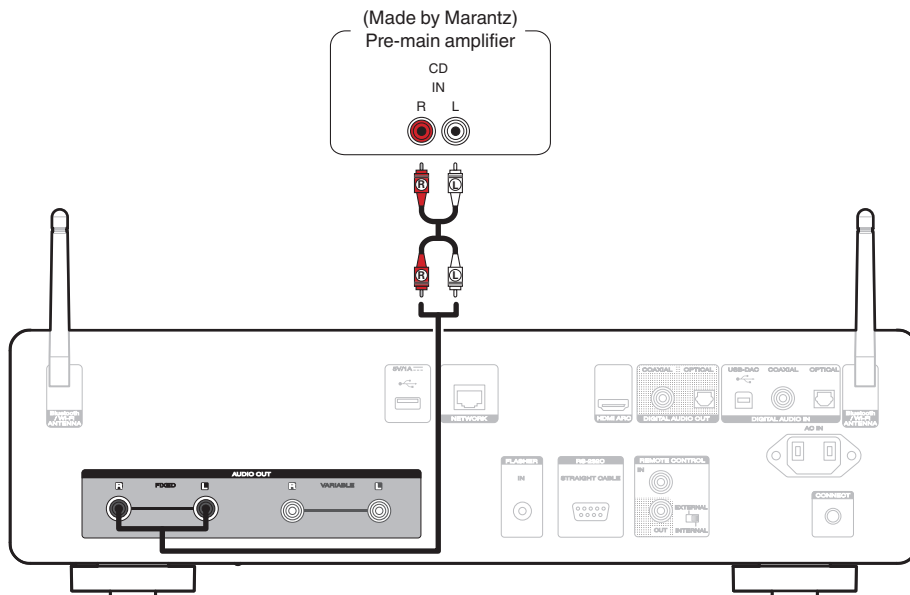

### NOTE

- To adjust the volume of the amplifier with the remote control, set the operation mode of the volume adjustment button of the remote control to the amplifier operation mode (factory settings). (👉 p. 116)
- To adjust the amplifier volume in the HEOS app, select “Line Out Level” in the settings menu to set the audio output terminal to “Fixed”. (👉 p. 102)
- It may not be possible to control the volume with the TV remote control (HDMI control function) depending on the Marantz amplifier and TV connected to this unit.





## ■ Switch the connection for each input source of the unit

When the analog audio output terminal (FIXED) of the unit is connected to the CD input terminal of the amplifier and the analog audio output terminal (VARIABLE) is connected to the power amplifier input terminal of the amplifier, the analog audio output terminal (VARIABLE/FIXED) used for each input source of the unit can be set.

For example, the audio of the CD can be input to the CD input terminal of the amplifier, and the audio of the HDMI ARC can be input to the power amplifier input terminal of the amplifier.

When listening to CDs, the volume of the amplifier can be adjusted with the VOLUME + and – buttons on the remote control, and when watching TV via HDMI ARC, the volume of the audio signal output from the unit can be adjusted with the TV remote control.

In addition to the analog audio input terminal of the Marantz amplifier, we recommend this connection if you will use the power amplifier input terminal.

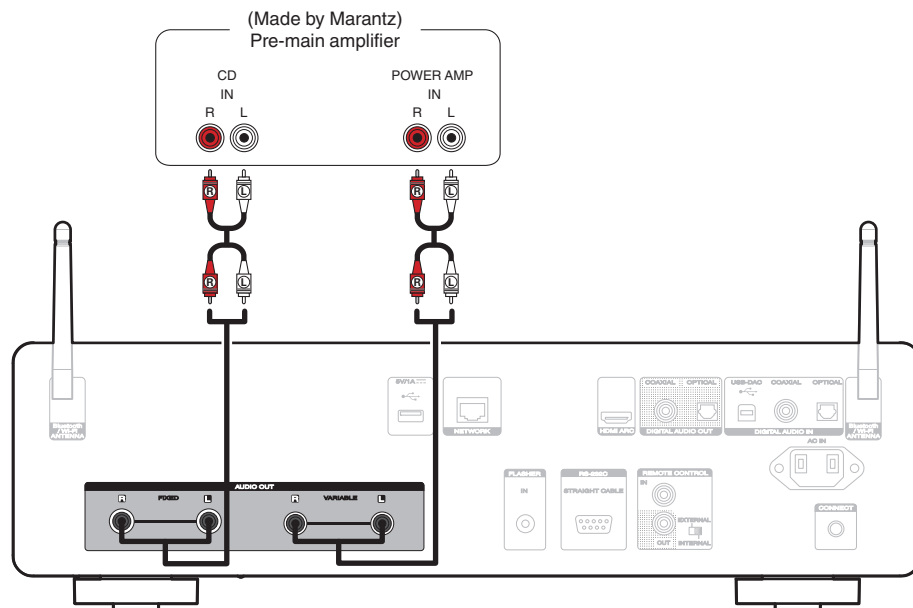

**NOTE**

- Select “Line Out Level” in the settings menu to set the audio output terminal to “Custom”. (🔗 p. 102)
- The input sources that can be set by selecting “Custom” in the settings menu are “HDMI”, “HEOS”, and “Bluetooth”. Other input sources are set to “Fixed”. (🔗 p. 102)
- If you have an HDMI ARC connection with the TV, it is recommended that you set the audio output terminal to “Variable” by selecting “Custom” - “HDMI” in the settings menu for comfortable volume adjustment. (🔗 p. 102)
- To adjust the volume of the audio signal output from the analog audio output terminal (VARIABLE) of the unit on the remote control, set the operation mode of the volume adjustment button on the remote control to the network CD player operation mode. (🔗 p. 116)
- A Marantz amplifier with a power amplifier input terminal is required.



## Connecting a TV

This unit can be connected to a TV for high-quality playback of the TV audio.

### Connecting this unit to the HDMI ARC terminal on a TV

If the HDMI terminal on your TV supports ARC, connect with HDMI.

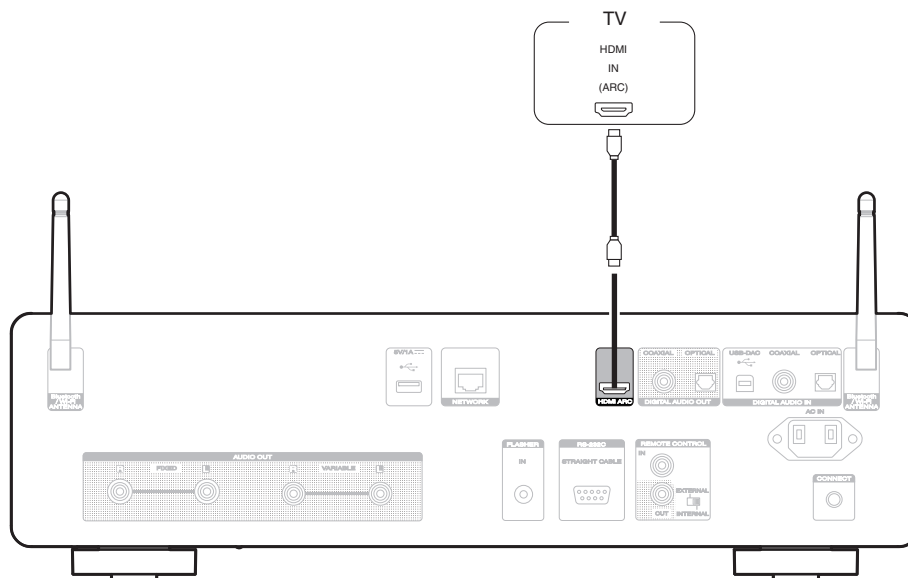



- When connecting a TV to this unit, turn off the audio output of the TV's internal speakers. See the owner's manual of your TV for details.
- When connecting the HDMI ARC terminal of this device to your TV, connect it to the HDMI input terminal of your TV that supports the ARC function.
- When connecting to a TV that does not support the ARC function, use an Optical connection or a Coaxial connection to play the TV audio. (👉 p. 29)
- While using HDMI ARC for TV connection it is highly recommended for the best volume control experience to use the variable output from this unit to connect to the amplifier. (👉 p. 21)

**NOTE**

- Only the PCM 2-channel setting can be used to play sound from a TV via the HDMI ARC function. Set "PCM 2ch" as the audio format in the TV settings.
- Linear PCM signals with a sampling frequency of 32 kHz, 44.1 kHz, 48 kHz, 88.2 kHz, 96 kHz, 176.4 kHz, or 192 kHz can be input into this unit.
- Do not input non-PCM signals, such as Dolby Digital, DTS and AAC. This causes noise and could damage the speakers.

**■ Specifications of supported audio formats**

See "Digital input" (👉 p. 145).



## Connecting this unit to the Optical or Coaxial terminal on a TV

If the HDMI terminal on your TV does not support ARC or your TV does not have any HDMI terminals, connect with an optical cable or a coaxial digital cable.

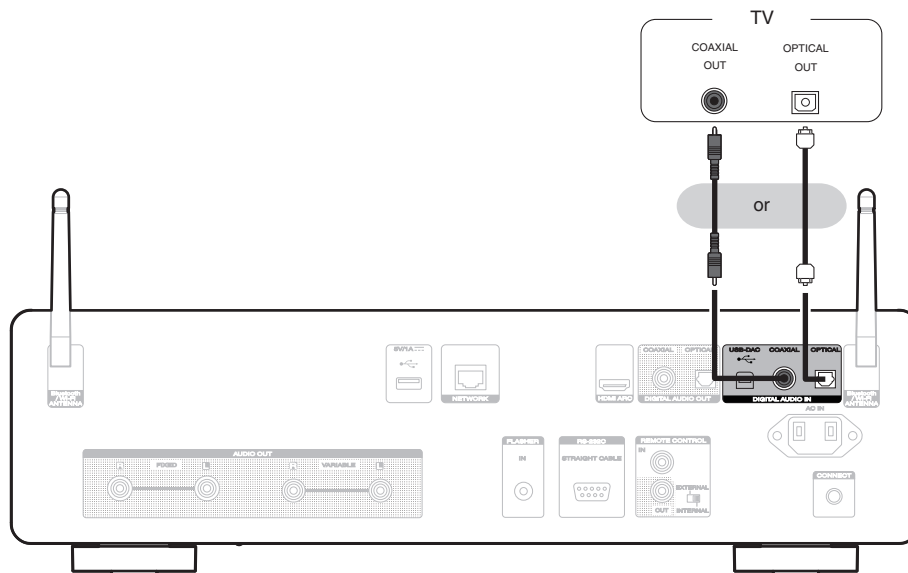



- When connecting a TV to this unit, turn off the audio output of the TV's internal speakers. See the owner's manual of your TV for details.

**NOTE**

- Linear PCM signals with a sampling frequency of 32 kHz, 44.1 kHz, 48 kHz, 88.2 kHz, 96 kHz, 176.4 kHz, or 192 kHz can be input into this unit.
- Do not input non-PCM signals, such as Dolby Digital, DTS and AAC. This causes noise and could damage the speakers.

## ■ Specifications of supported audio formats

See "Digital input" (🔍 p. 145).



## Connecting to a device with digital audio input connectors

You can enjoy digital audio playback by connecting an amplifier or D/A converter that has a digital audio connector to this unit.

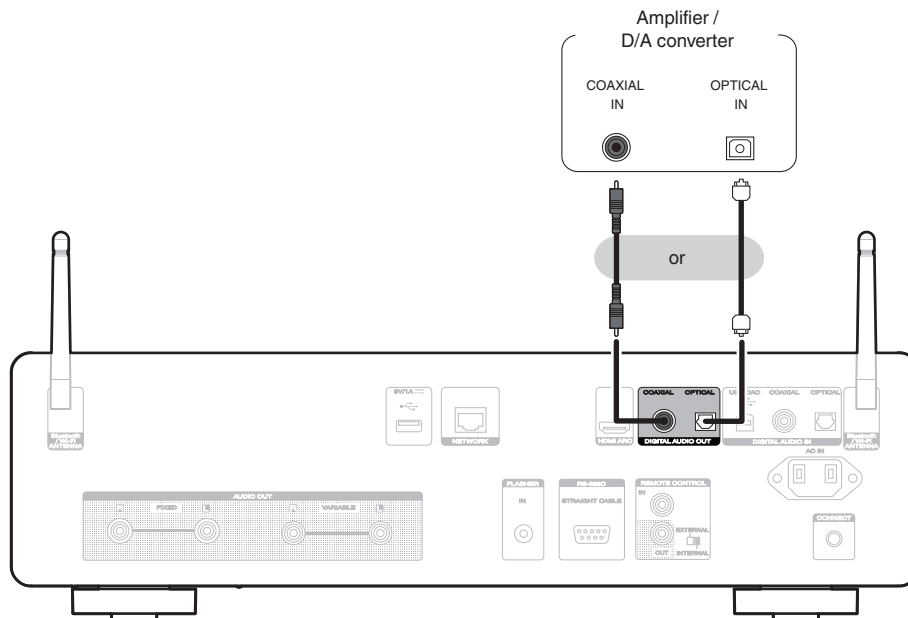

### NOTE

- Digital audio output stops during playback of the DSD signals and linear PCM signals with a sampling frequency of 352.8/384 kHz using this unit's USB-DAC.
- Digital audio output stops during playback of the DSD files via USB and networks.
- Digital audio output can be set on/off using "Digital Out" in the setup menu. (🔧 p. 105)



## Connecting to a device with digital audio output connectors

Use this connection to input digital audio signals to this unit, and convert the signals for playback using the D/A converter of this unit. (🔗 p. 76)

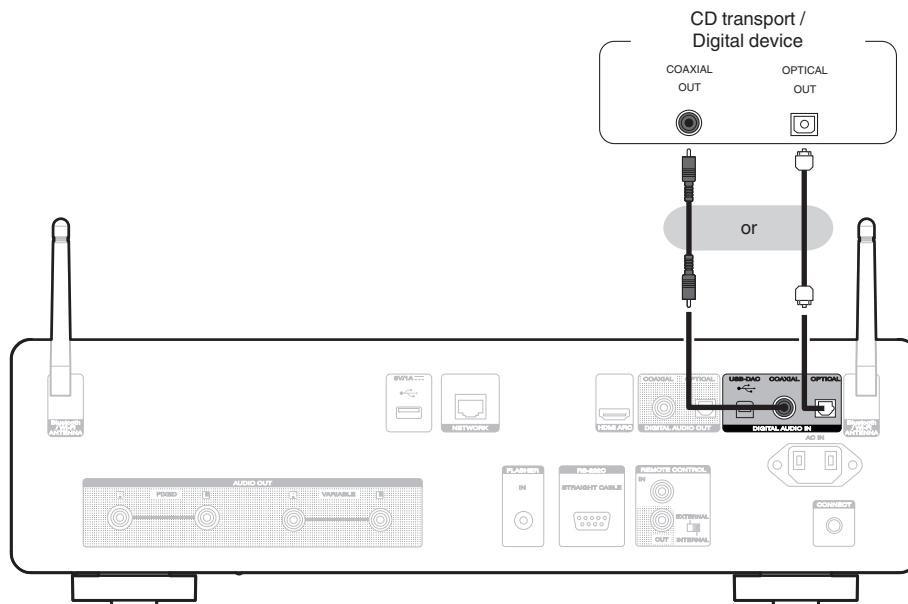

### ■ Specifications of supported audio formats

See "Digital input" (🔗 p. 145).



## Connecting a PC or Mac

By connecting a computer to the USB-DAC port on the rear panel of this unit using a commercially available USB connecting cable, this unit can be used as a D/A converter. (🔗 p. 78)

### NOTE

- Before USB connecting this unit to your computer, install the driver software in your computer. (🔗 p. 78)
- Download the driver software from the CD 50n page of the Marantz website.
- Use a cable that is 10 ft (3 m) or less to connect to the computer.

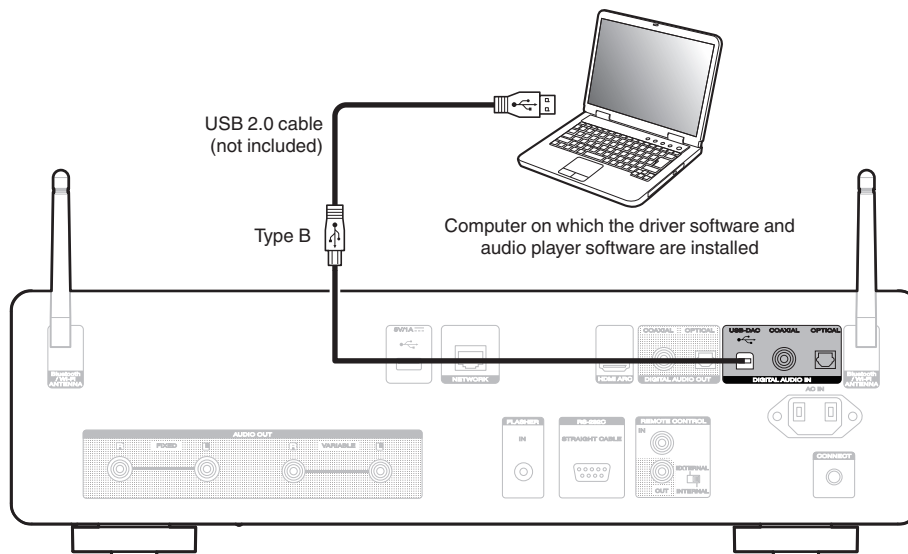

## Connecting a USB flash drive to the USB port

For operating instructions see “Playing a USB flash drive” (🔗 p. 49).

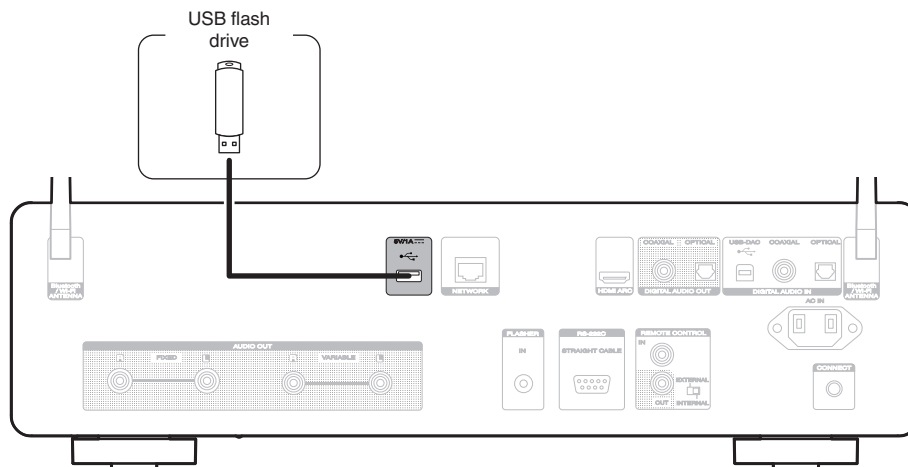

- Marantz does not guarantee that all USB flash drives will operate or receive power. When using a portable USB hard disk drive (HDD) which came with an AC adapter, use that device's included AC adapter.

### NOTE

- USB flash drives will not work via a USB hub.
- It is not possible to use this unit by connecting the rear panel's USB port to a computer via a USB cable. Connection to a computer is possible via the digital input USB-DAC port (Type B) on the rear panel.
- Do not use an extension cable when connecting a USB flash drive. This may cause radio interference with other devices.



## Connecting to a home network (LAN)

This unit can connect to a network using a wired LAN or wireless LAN. You can connect this unit to your home network (LAN) to enable various types of playback and operations as described below.

- Playback of network audio such as Internet Radio and from your media server(s)
- Playback of streaming music services
- Using the Apple AirPlay function
- Operation on this unit via the network
- Operation with the HEOS wireless multi-room sound system
- Firmware Update

**For connections to the Internet, contact an ISP (Internet Service Provider) or a computer shop.**



- When  is displayed on the display of this unit, this unit is not connected to a network.

### Wired LAN

To make connections via wired LAN, use a LAN cable to connect the router to this unit as shown in the figure below.

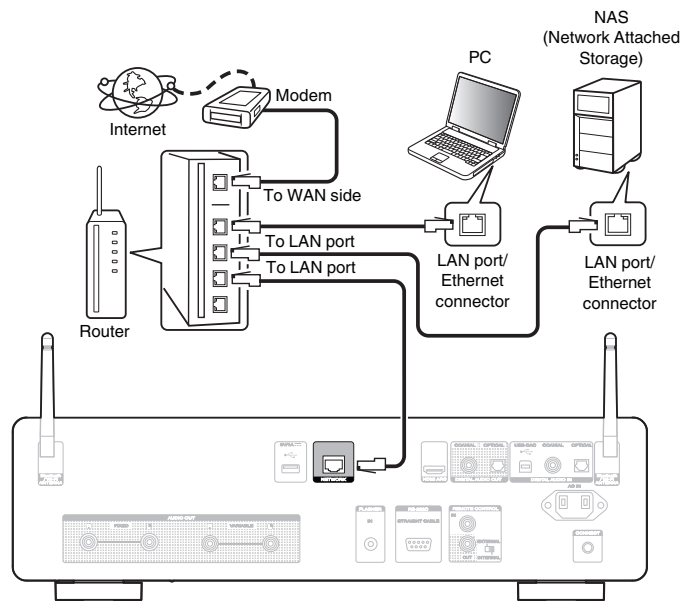

## Wireless LAN

When connecting to the network via wireless LAN, connect the external antennas for Bluetooth/wireless connectivity connection to the rear panel and stand them upright.

To connect to a wireless LAN router, download the HEOS app to your smartphone, and set up this unit. (☞ p. 59)

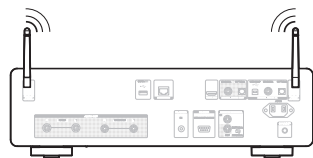
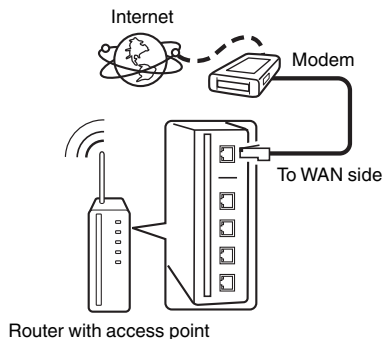

- When using this unit, we recommend you use a router equipped with the following functions:
  - Built-in DHCP server  
This function automatically assigns IP addresses on the LAN.
  - Built-in 100BASE-TX switch  
When connecting multiple devices, we recommend a switching hub with a speed of 100 Mbps or greater.
- Only use a shielded STP or ScTP LAN cable (readily available at electronics stores). (CAT-5 or greater recommended)
- The normal shielded-type LAN cable is recommended. If a flat-type cable or unshielded-type cable is used, other devices could be affected by noise.

### NOTE

- The types of routers that can be used depend on the ISP. Contact your ISP or a computer shop for details.
- This unit is not compatible with PPPoE. A PPPoE compatible router is required if your contracted line is not set using PPPoE.
- Do not connect a NETWORK connector directly to the LAN port/ Ethernet connector on your computer.
- Various online services may be discontinued without prior notice.



## Connecting an external control device

### FLASHER IN jack

This unit can be controlled by connecting a control box or other control device to this unit.

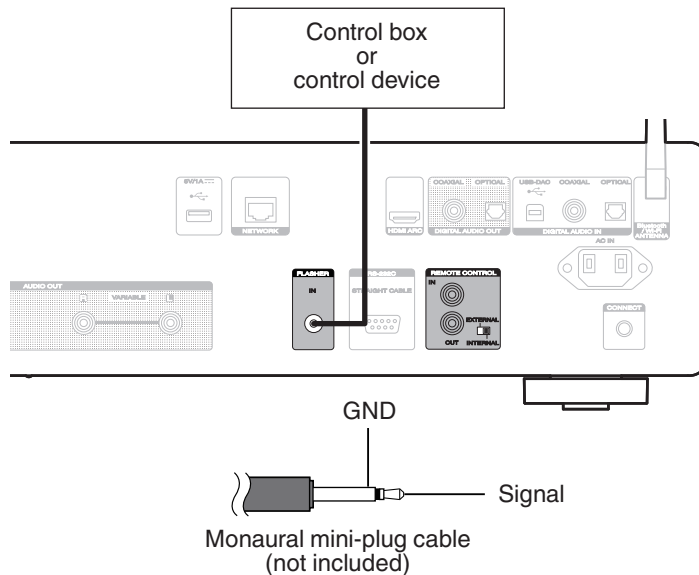

- To use the FLASHER IN jack, set the EXTERNAL/INTERNAL switch to "INTERNAL".



## REMOTE CONTROL connectors

The following functions can be used when this unit is connected to a Marantz amplifier.

- Controlling the amplifier through this unit using the HEOS app.
- Controlling the amplifier through this unit, using the TV remote control (HDMI control function).
- Synchronizing the power operations of this unit and the amplifier
  - Turning on the power to this unit turns on the power to the amplifier and switches the amplifier input source to “POWER AMP” or “CD”.
  - Switching this unit to standby mode also switches the amplifier to standby mode.



- When “Line Out Level” is set to “Variable” in the setup menu, the amplifier input source will switch to “POWER AMP”. When “Fixed” is set, the amplifier input source will switch to “CD”. (🔧 p. 102)
- When “Line Out Level” in the settings menu is set to “Custom”, switching the input source of the unit will switch the input source of the amplifier to “POWER AMP” or “CD” according to the settings. (🔧 p. 102)
- When “Power Sync” is set to “Off” in the setup menu, the amplifier power will not turn on automatically even when this unit is turned on. (🔧 p. 110)

Next, configure the “Connection” and “Setting”.



- Some operations may not be possible on some Marantz amplifiers.
- It may not be possible to control the volume with the TV remote control (HDMI control function) depending on the Marantz amplifier and TV connected to this unit.

### ■ Connection

Use the supplied remote connector cable to connect the REMOTE CONTROL IN connector of this unit to REMOTE CONTROL OUT connector of the amplifier.

### ■ Setting

Turn the EXTERNAL/INTERNAL switch on the unit to “EXTERNAL”.

- This setting will disable remote sensor reception of this unit.
- To operate the unit, point the remote control at the remote sensor of the amplifier.



- To use this unit by itself without connecting an amplifier, turn the switch to “INTERNAL”.



This unit

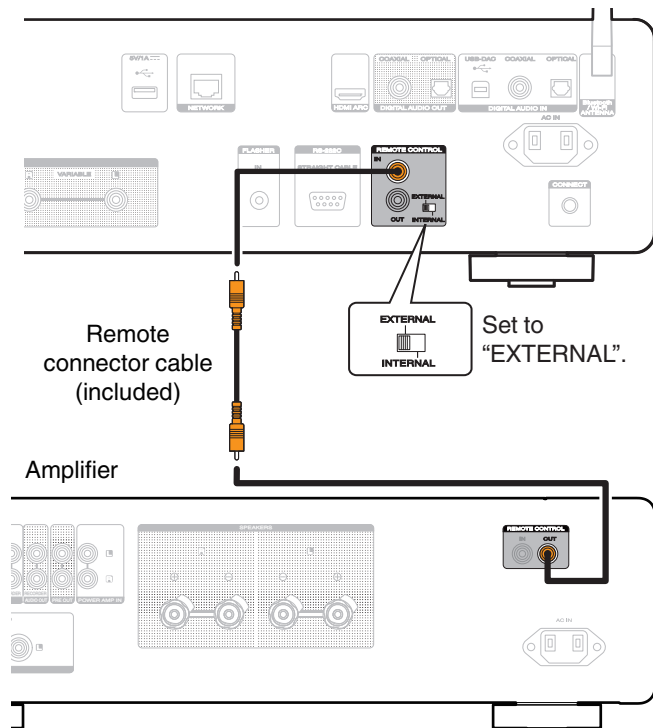

#### NOTE

- When connecting some Marantz amplifiers, it may be necessary to configure the following settings to easily adjust the volume using the HDMI ARC function of your TV.
  - If there is an EXTERNAL/INTERNAL switch on the rear panel of your amplifier.
    - Turn the EXTERNAL/INTERNAL switch on this unit to "INTERNAL".
    - Turn the EXTERNAL/INTERNAL switch on this amplifier to "EXTERNAL".
    - This setting will disable remote sensor reception of this amplifier.
    - To operate the unit, point the remote control at the remote sensor of this unit.
  - If your amplifier's remote sensor reception function can be set to "Disable".
    - Turn the EXTERNAL/INTERNAL switch on this unit to "INTERNAL".
    - Set the remote sensor reception function to "Disable".
    - This setting will disable remote sensor reception of this amplifier.
    - To operate the unit, point the remote control at the remote sensor of this unit.



## Connecting the power cord

After completing all the connections, insert the power plug into the power outlet.

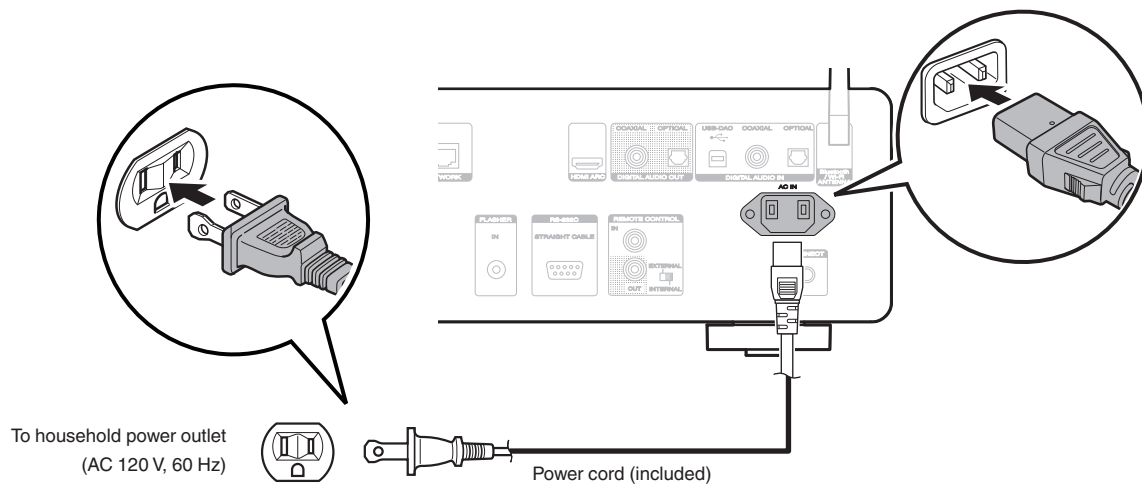

## ■ Contents

### Basic operation

Turning the power on	42
Switching the power to standby	42
Selecting the input source	43

### Playback network audio/service

Listening to Internet Radio	44
Playing back files stored on PC or NAS	46
Getting the HEOS app	59
AirPlay function	87
Spotify Connect function	90

### Playback a device

Playing a USB flash drive	49
Listening to music on a Bluetooth device	52
Listening to audio on Bluetooth headphones	56
Playing CDs	70
Playing DATA CDs	73
Playing digital input	76

### Convenience functions

Playing back HEOS Favorites	92
Adding to HEOS Favorites	92
Deleting a HEOS Favorites	93
Switching the display's brightness	93
Using the sleep timer	94



## Basic operation

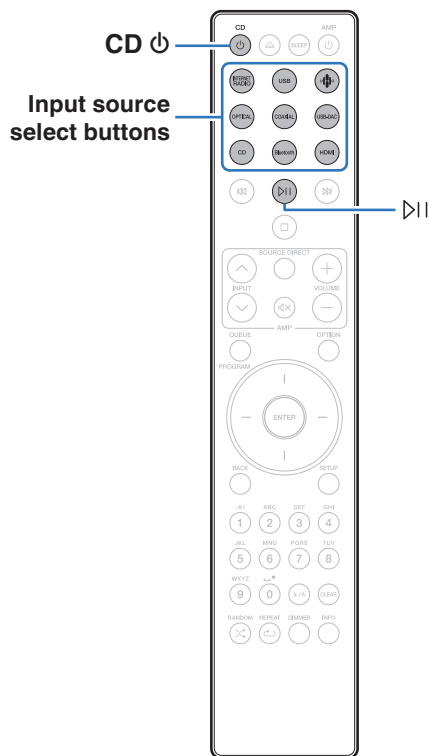

### Turning the power on

#### 1 Press CD ⏻ to turn on power to the unit.



- You can also press ⏻ on the main unit to turn on power from standby mode.
- You can also press DII to turn on power from standby mode.

### Switching the power to standby

#### 1 Press CD ⏻.

The unit switches to standby mode.



- You can also switch the power to standby by pressing ⏻ on the main unit.

#### NOTE

- Power continues to be supplied to some of the circuitry even when the power is in the standby mode. When leaving home for long periods of time or when going on vacation, unplug the power cord from the power outlet.



## Selecting the input source

### 1 Press the input source select button to be played back.

The selected input source appears on the display.



- You can also select the input source by turning INPUT selector on the main unit.



# Listening to Internet Radio

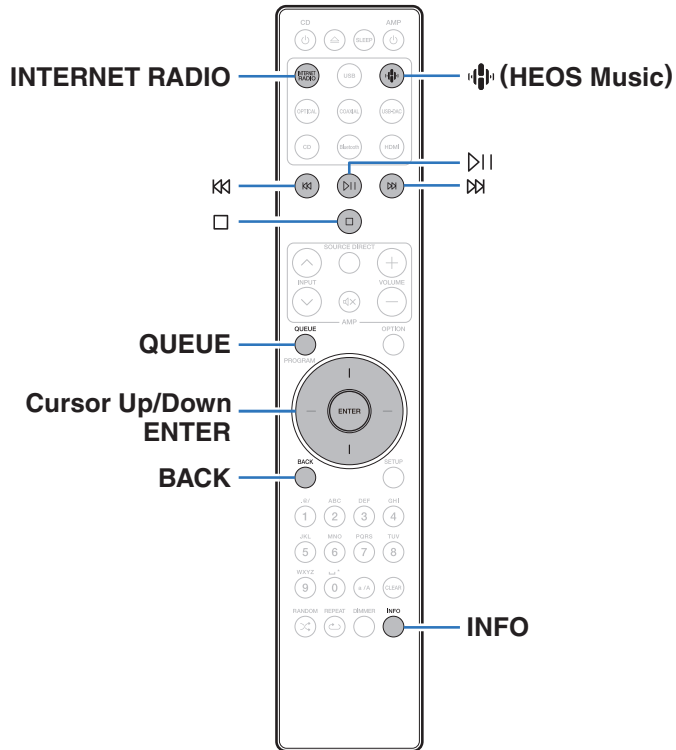

- Internet Radio refers to radio broadcasts distributed over the Internet. Internet Radio stations from around the world can be received.
- The Internet Radio station list on this unit the database service provided by TuneIn Radio service.
- The audio format types and specifications supported by this unit for playback are as follows.  
See “Playing back Internet Radio” (p. 147) for details.

- WMA
- MP3
- MPEG-4 AAC





## Listening to Internet Radio

### 1 Press INTERNET RADIO.

- You can also press  (HEOS Music). Use Cursor Up/Down buttons to select "Internet Radio", then press ENTER.

### 2 Select the station you want to play.

Operation buttons	Function
 *	Playback / Pause
	Stop
 *	Skip to previous track / Skip to next track
<b>Cursor Up/Down</b>	Select the item
<b>ENTER</b>	Enter the selected item / Playback
<b>BACK</b>	Moving up a level in the hierarchy
<b>INFO</b>	Switching the song name - artist name, radio station name and file format
<b>QUEUE</b>	This displays the queue

\* Enabled when playing Podcasts.



- Any characters that cannot be displayed are replaced with "." (period).

#### NOTE

- The radio station database service may be suspended or be otherwise unavailable without notice.



## Playing back files stored on PC or NAS

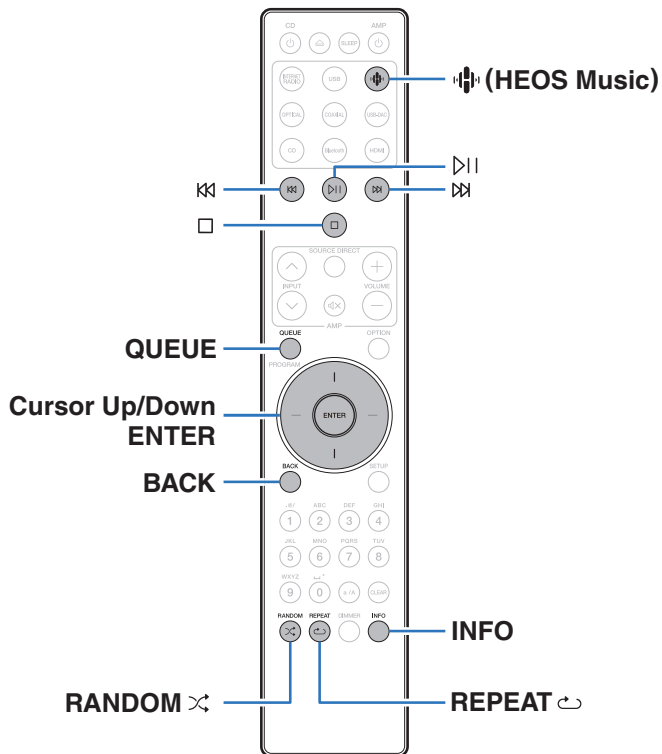

- This unit can play back music files and playlists (m3u, wpl) from DLNA compatible servers including PCs and NAS devices on your network.
- The audio format types and specifications supported by this unit for playback are as follows.  
See “Playing back files stored on a PC and NAS” (p. 146) for details.

- WMA
- MP3
- WAV
- MPEG-4 AAC
- FLAC
- Apple Lossless
- DSD



## Playing back files stored on PC or NAS

Use this procedure to play music files or playlists stored on DLNA files servers on your local network.

### 1 Press (HEOS Music).

If a playback history is present, the last Internet radio station or song played is played back. Pressing  (HEOS Music) again displays the HEOS Music top menu.

### 2 Use Cursor Up/Down buttons to select “Music Servers”, then press ENTER.

### 3 Select the name of your networked PC or NAS (Network Attached Storage) server.

## 4 Browse the music on your PC/NAS and select something to play.



- When you select something to play you will be asked how you want to queue up your music.

<b>Play Now:</b>	Inserts the item into the queue after the currently playing track and plays the selected item immediately.
<b>Play Now &amp; Replace Queue:</b>	Clears the queue and plays the selected item immediately.
<b>Play Next:</b>	Inserts the item into the queue after the currently playing track and plays it when the currently playing track ends.
<b>Add to End of Queue:</b>	Adds the item to the end of the queue.



## 5 Use Cursor Up/Down buttons to select the “Play Now” or “Play Now & Replace Queue”, then press ENTER.

Playback starts.

Operation buttons	Function
▷	Playback / Pause
□	Stop
⏮ ⏭	Skip to previous track / Skip to next track
<b>Cursor Up/Down</b>	Select the item
<b>ENTER</b>	Enter the selected item
<b>BACK</b>	Moving up a level in the hierarchy
<b>REPEAT</b> ↺	Repeat playback <ul style="list-style-type: none"> <li>Switching between Single-track repeat and All-track repeat</li> </ul>
<b>RANDOM</b> ✂	Random playback
<b>INFO</b>	Switching the song name - artist name, album name and file format
<b>QUEUE</b>	This displays the queue

### NOTE

- When playing back music files with your PC or NAS connected through wireless LAN, audio may be interrupted depending on your wireless LAN environment. In this case, connect using a wired LAN.
- The order in which the tracks/files are displayed depends on the server specifications. If the tracks/files are not displayed in alphabetical order due to the server specifications, searching by the first letter may not work properly.





## Playing files stored on USB flash drives

- 1 Insert the USB flash drive into the USB port.
- 2 Press **USB** to switch the input source to “USB Music”.
  - You can also press  (HEOS Music). Use Cursor Up/Down buttons to select “USB Music”, then press ENTER.
- 3 Select the name of this unit.

- 4 Browse the music on your USB flash drive and select something to play.



- When you select something to play you will be asked how you want to queue up your music.

<b>Play Now:</b>	Inserts the item into the queue after the currently playing track and plays the selected item immediately.
<b>Play Now &amp; Replace Queue:</b>	Clears the queue and plays the selected item immediately.
<b>Play Next:</b>	Inserts the item into the queue after the currently playing track and plays it when the currently playing track ends.
<b>Add to End of Queue:</b>	Adds the item to the end of the queue.

- 5 Use Cursor Up/Down buttons to select the “Play Now” or “Play Now & Replace Queue”, then press ENTER. Playback starts.



Operation buttons	Function
▶	Playback / Pause
□	Stop
⏮ ⏭	Skip to previous track / Skip to next track
<b>Cursor Up/Down</b>	Select the item
<b>ENTER</b>	Enter the selected item / Playback
<b>BACK</b>	Moving up a level in the hierarchy
<b>REPEAT</b> ↺	Repeat playback <ul style="list-style-type: none"> <li>• Switching between Single-track repeat and All-track repeat</li> </ul>
<b>RANDOM</b> ✂	Random playback
<b>INFO</b>	Switching the song name - artist name, album name and file format
<b>QUEUE</b>	This displays the queue

**NOTE**

- Note that Marantz will accept no responsibility whatsoever for any problems arising with the data on a USB flash drive when using this unit in conjunction with the USB flash drive.
- When a USB flash drive is connected to this unit, the unit loads all of the files on the USB flash drive. Loading may take a while if the USB flash drive contains a large number of folders and/or files.





## Listening to music on a Bluetooth device

In order to enjoy music from a Bluetooth device on this unit, the Bluetooth device must first be paired with this unit.

Once the Bluetooth device has been paired, it does not need to be paired again.

### 1 Prepare for playback.

- ① Connect the supplied external antennas for Bluetooth/wireless connectivity to the Bluetooth/wireless LAN antenna connectors on the rear panel. (👉 p. 12)
- ② Press CD  to turn on power to the unit.

### 2 Press Bluetooth.

When playing content via Bluetooth on this unit for the first time, the unit will go into the pairing mode automatically.



### 3 Activate the Bluetooth settings on your Bluetooth device.

### 4 Select this unit when its name appears in the list of devices displayed on the screen of the Bluetooth device.

Perform the connection with the Bluetooth device close to the unit (about 3.3 ft/1 m).

### 5 Play music using any app on your Bluetooth device.

- The Bluetooth device can also be operated with the remote control of this unit.
- The next time the Bluetooth button is pressed on the remote control unit, this unit automatically connects to the last Bluetooth device that was connected.

Operation buttons	Function
	Playback / Pause
	Skip to previous track / Skip to next track
INFO	Switching the song name - artist name, Bluetooth device name and album name.



## Pairing with other Bluetooth devices

Pair a Bluetooth device with this unit.

- 1 Activate the Bluetooth settings on your Bluetooth device.**
- 2 Press and hold Bluetooth on the remote control unit for at least 3 seconds.**

This unit will go into the pairing mode.
- 3 Select this unit when its name appears in the list of devices displayed on the screen of the Bluetooth device.**



- This unit can be paired with a maximum of 8 Bluetooth devices. When a 9th Bluetooth device is paired, it will be registered in place of the oldest registered device.
- You can also enter pairing mode by pressing the OPTION button when the Bluetooth playback screen is displayed and selecting "Pairing Mode" from the displayed option menu.

### NOTE

- To operate the Bluetooth device with the remote control of this unit, the Bluetooth device needs to support the AVRCP profile.
- The remote control of this unit is not guaranteed to work with all Bluetooth devices.
- For some Bluetooth devices, the volume set on the Bluetooth device is linked with that of the audio signal output from the analog audio output terminals (VARIABLE) of this unit.



## Reconnecting to this unit from a Bluetooth device

After pairing is completed, the Bluetooth device can be connected without performing any operations on this unit.

This operation also needs to be performed when switching the Bluetooth device for playback.

- 1 If a Bluetooth device is currently connected, deactivate the Bluetooth setting of that device to disconnect it.**
- 2 Activate the Bluetooth setting of the Bluetooth device to be connected.**
- 3 Select this unit from the Bluetooth device list on your Bluetooth device.**
- 4 Play music using any app on your Bluetooth device.**



- When the power of this unit and the Bluetooth function of this unit are turned on, the input source will be automatically switched to “Bluetooth” if a Bluetooth device is connected.
- When the “Network Control” setting of this unit is set to “On” and a Bluetooth device is connected and is played with the unit in the standby state, the power of the unit will be turned on automatically. (📖 p. 113)



## Listening to audio on Bluetooth headphones

---

You can listen to the sounds that are played back in this device from Bluetooth headphones.

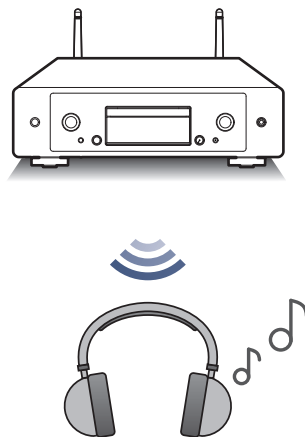

## Listening to audio on Bluetooth headphones

- 1** Set “Headphone” to “On” from the “Network” - “Bluetooth” setting in the setup menu. (👉 p. 112)
- 2** Enter pairing mode on the Bluetooth headphones you want to connect to this unit.
- 3** Select “Devices” and select the name of the Bluetooth headphones from the device list.
- 4** Adjust the volume of connected Bluetooth headphones after the connection is completed.



- A2DP profile-compatible Bluetooth speakers can be connected following the same steps used to connect Bluetooth headphones.

### NOTE

- Bluetooth headphones volume cannot be adjusted from this unit. Adjust volume of your Bluetooth headphones.
- Audio may be delayed when sent over Bluetooth.
- AirPlay and Roon Ready audio cannot be transmitted.
- Bluetooth headphones cannot be connected when use a Bluetooth input source. Furthermore, selecting a Bluetooth input source will terminate the connection between this unit and Bluetooth headphones.
- Bluetooth headphones cannot be connected when this unit is grouped in the HEOS app.
- Bluetooth headphones cannot be connected if a HEOS Built-in device is playing an input source from this unit.

### CAUTION:

#### Using Bluetooth headphones without a volume adjustment function

- In order to avoid hearing loss, do not connect Bluetooth headphones that lack volume adjustment functionality.
- Bluetooth headphone volume may be unexpectedly loud when this unit connects to Bluetooth headphones.
- Bluetooth headphone volume cannot be adjusted from this unit.



## Reconnecting to a Bluetooth headphones

Follow any of the steps below to reconnect the most recently used Bluetooth headphones:

- Reconnect to this unit with Bluetooth headphone's reconnect function.
- Select the device you wish to connect from the "Devices" under "Bluetooth" in the setup menu. (🔗 p. 112)

## Disconnecting Bluetooth headphones

Complete any of the following steps to disconnect your Bluetooth headphones:

- Turn off your Bluetooth headphones.
- In the setup menu, go to "Network" - "Bluetooth", and set "Headphone" to "Off". (🔗 p. 112)



## Getting the HEOS app

You can use many online music streaming services from the HEOS app. Depending upon your geographical location, there are several options to choose from.

Download the HEOS app for iOS or Android by searching App Store, Google Play store or Amazon Appstore for “HEOS”.



- Specifications of the HEOS app may be changed without prior notice for improvement purposes.



## Setting up the HEOS app for the first time with a HEOS Built-in device

Once you have placed this unit in your listening room and have downloaded the HEOS app, you are ready to configure this unit for music playback. This involves following a few simple steps to get this unit connected to your existing home network:



- DO NOT connect the Ethernet cable if you are connecting this unit to a wireless network. If you are connecting this unit to a wired network, use an Ethernet cable (not included) to connect this unit to your network or router.

### 1 Make sure your mobile device is connected to your wireless network (the network you want to connect to this device).

You can check this in the “Settings” - “Wi-Fi” menu of your iOS or Android device.



- Activate the Bluetooth setting on your mobile device.
- If your wireless network is secure, make sure you know the password to join your network.

### 2 Launch the HEOS app on your mobile device.

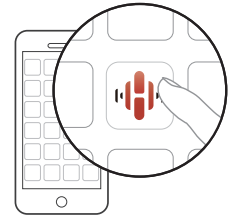

### 3 Tap the “Setup Now” button at the top of the screen.

### 4 Follow the instructions to add this unit to your wireless network and to select an input on this unit.



## Adding the registration of HEOS Built-in devices in the HEOS app

The HEOS system is a true multiroom audio system that automatically synchronizes audio playback between multiple HEOS Built-in devices so that the audio coming from different rooms is perfectly in sync and always sounds amazing! You can easily add up to 32 HEOS Built-in devices to your HEOS system.

### ■ Adding wired HEOS Built-in devices

Just connect the HEOS Built-in devices to your home network using an Ethernet cable and the HEOS Built-in device will appear on your HEOS app as a new room in the Rooms screen. For information about wired LAN connections, refer to “Connecting to a home network (LAN)” (🔗 p. 35).

At your convenience, you can assign a name to the HEOS Built-in device to indicate which room you have it placed in.

### ■ Adding wireless HEOS Built-in devices

You can add additional wireless HEOS Built-in devices to your HEOS system by selecting “Add Device” from the HEOS app’s settings menu and follow the instructions:

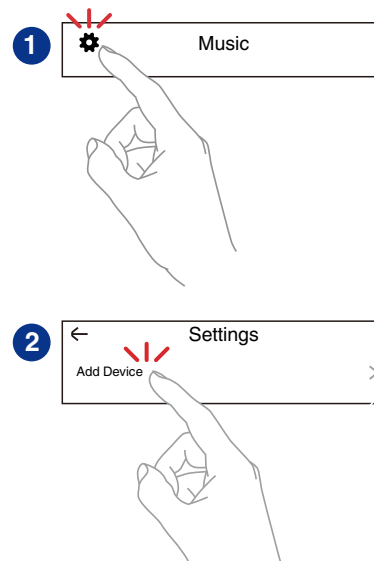

## HEOS Account

HEOS Accounts can be registered by tapping “Music” tab - “Settings” icon  in the HEOS app.

Once you create or sign into your HEOS Account, you can use the HEOS Favorites feature to save and recall your favorite streaming radio stations using this unit.

### ■ What is a HEOS Account?

A HEOS Account is master account or “keychain” for managing all of your HEOS music services with one single username and password.

### ■ Why do I need a HEOS Account?

With the HEOS Account you just have to enter your music services login names and passwords one time. This allows you to easily and quickly use multiple controller apps on different devices.

You just log into your HEOS Account on any device and you will have access to all of your associated music services, play history and custom playlists, even if you are at a friend's house listening to music on their HEOS system.

### ■ Signing up for a HEOS Account

You will be instructed to sign up for a HEOS Account the first time you try to access any music service from the main “Music” menu of the HEOS app. Follow the instructions in the HEOS app to complete the operation.



- This unit's HEOS Account setting information is synced with the HEOS app. Change settings and sign out of your account through the HEOS app.

### ■ Changing your HEOS Account

- 1 Tap the “Music” tab.
- 2 Select the Settings icon  in the upper left corner of the screen.
- 3 Select “HEOS Account”.
- 4 Change your location, change your password, delete your account or sign out of your account.



- This unit automatically syncs when you change your account settings or sign out through the HEOS app. To switch HEOS accounts, play back music from an HEOS app signed in to the account you wish to sync to this unit. The “HEOS Account” switches automatically.



## Playing from streaming music services

A music service is an online music company that provides access to vast music collections via free and/or paid subscriptions. Depending upon your geographical location, there are several options to choose from.

### NOTE

- The HEOS app and brand is not affiliated with any manufacturer of any mobile device. Availability of music services may vary by region. Not all services may be available at time of purchase. Some services may be added or discontinued from time to time based on decisions of the music service providers or others.

## ■ Selecting a room/device

- 1 Tap the “Rooms” tab. Select “Marantz CD 50n” if there are multiple products with HEOS Built-in.



- Tap the Pencil icon  at the top right to switch edit mode. You can change the displayed name.

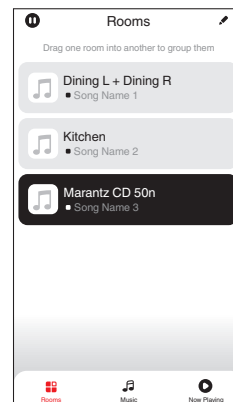

## ■ Selecting the music track or station from music sources

### 1 Tap the “Music” tab and select a music source.



- All music services displayed may not be available in your location.

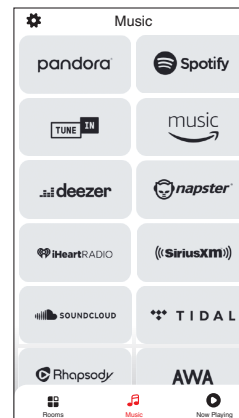

## 2 Browse the music to play.

After selecting a music track or radio station the app will automatically change to the “Now Playing” screen.



- When you select a music track to play you will be asked how you want to queue up your music.

<b>Play Now:</b>	Inserts the item into the queue after the currently playing track and plays the selected item immediately.
<b>Play Now &amp; Replace Queue:</b>	Clears the queue and plays the selected item immediately.
<b>Play Next:</b>	Inserts the item into the queue after the currently playing track and plays it when the currently playing track ends.
<b>Add to End of Queue:</b>	Adds the item to the end of the queue.



- When you select a radio station the following items are displayed.

<b>Play Now:</b>	Plays the selected item immediately.
<b>Add to HEOS Favorites:</b>	Adds to HEOS Favorites.



- Set “Network Control” of the setup menu to “On” so that when you are playing back from the HEOS app while this device is in standby, this device turns on automatically. (“Network Control” (🔧 p. 113))

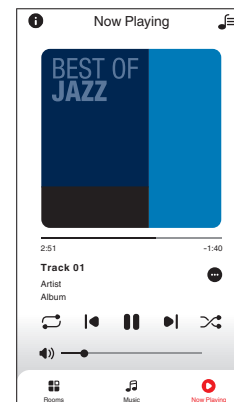
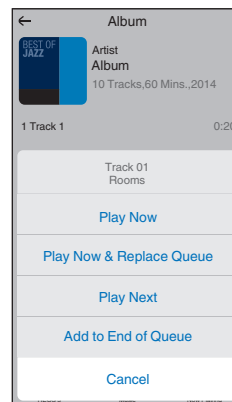

## Listening to the same music in multiple rooms

This system is a true multi-room audio system. You can create one or more HEOS groups to automatically synchronize audio playback between multiple products with HEOS Built-in so that the music playing different rooms is perfectly in sync and always sounds amazing! You can easily add up to 32 products to your system in total. You can group up to 16 individual products to have them play the same song fully synchronized.

### ■ Grouping rooms

- 1** Press and hold your finger on room that is not playing music.
- 2** Drag it into the room that is playing music and lift your finger.
- 3** The two rooms will be grouped together into a single device group and both rooms will be playing the same music in perfect sync.

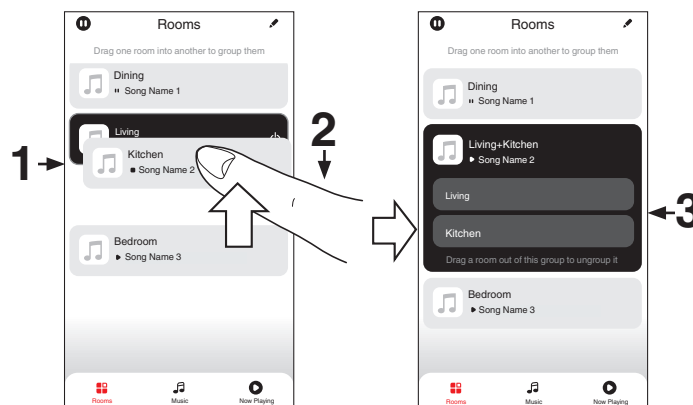

## ■ Ungrouping rooms

- 1 Press and hold your finger on room that you want to remove from the group.**
- 2 Drag it out of the group and lift your finger.**

### NOTE

- You can not remove the first room that started playing the music before grouping.

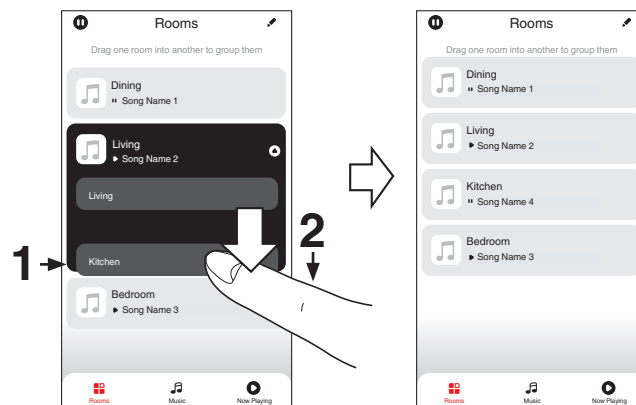

## ■ Grouping all rooms (party mode)

You can easily group 16 rooms together into Party Mode by using a “pinch” gesture.

- 1** Place two fingers on the screen over the list of rooms.
- 2** Quickly pinch your two fingers together and release.
- 3** All of your rooms will be joined together and begin playing the same music in perfect sync.

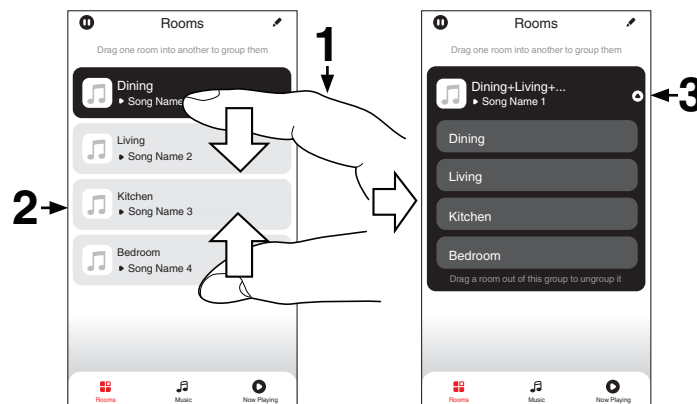

## ■ Ungrouping all rooms

You can easily ungroup all of your rooms and exit Party Mode by using a “spread” gesture.

- 1 Place two fingers close together on the screen over list of rooms.**
- 2 Quickly spread your two fingers apart from each other and release.**
- 3 All of your rooms will be ungrouped.**

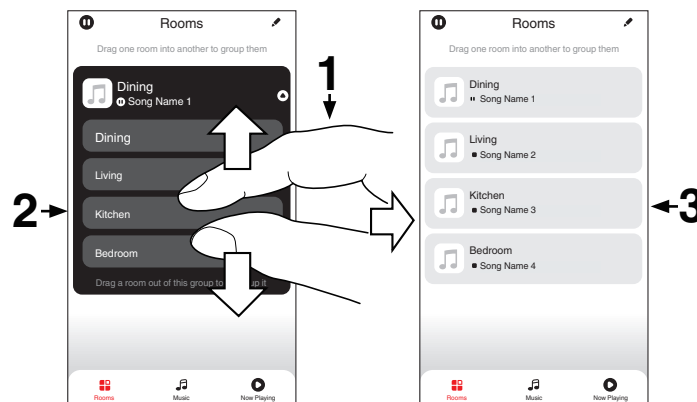

# Playing CDs

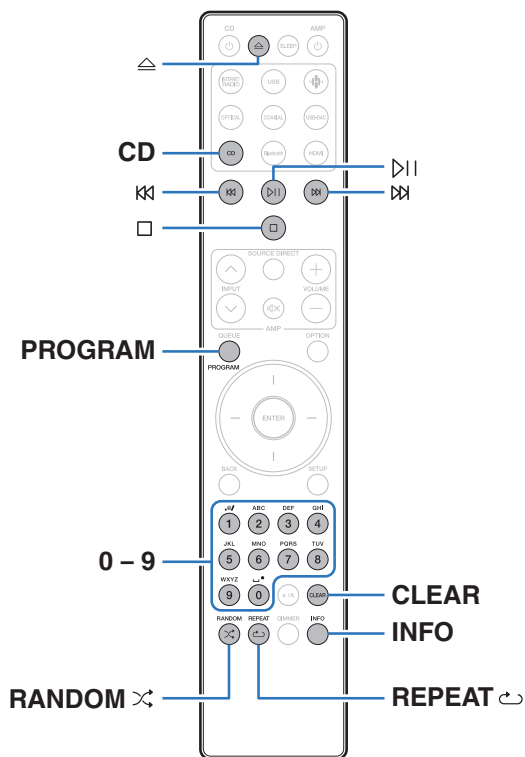

## Playing CDs

**1** Press **CD** to switch the input source to “CD”.

**2** Press **△** to insert a disc.



- You can also open/close the disc tray by pressing **△** on the main unit.
- You can also close the disc tray by pressing **⏪**. This automatically starts playback.





**3** Press **⏪**.

The **▶** indicator lights on the display. Playback starts.

### NOTE

- Do not place any foreign objects in the disc tray. Doing so could damage the set.
- Do not push the disc tray in by hand when the power is turned off. Doing so could damage the set.



Operation buttons	Function
	Playback / Pause
	Stop
	Skip to previous track / Skip to next track (Press and hold) Fast-reverse / Fast-forward
<b>0 - 9</b>	Select the track
<b>RANDOM</b> 	Random playback
<b>REPEAT</b> 	Repeat playback <ul style="list-style-type: none"> <li>Switching between All-track repeat and Single-track repeat.</li> </ul>
<b>INFO</b>	Time display switching <ul style="list-style-type: none"> <li>Switching between elapsed time of the current track and remaining time of the current track.</li> </ul>

## ■ Playing a specific track (Direct searching)

### 1 Use 0 – 9 to select the tracks.

#### [Example]

Track 4 : Press number 4 to select track 4.

Track 12 : Press numbers 1 and 2 consecutively to select track 12.

- The number you enter is set about 1.5 seconds after you press the number buttons. To enter a two-digit number, be sure to press the two number buttons, one immediately after the other.



## Playing tracks in a specific order (Program playback)

Up to 25 tracks can be programmed.

### 1 In the stop mode, press PROGRAM.

“Program” is displayed on the display.

### 2 Use 0 – 9 to select the tracks.

[Example]

Track 4 : Press number 4 to select track 4.

Track 12 : Press numbers 1 and 2 consecutively to select track 12.

- The number you enter is set about 1.5 seconds after you press the number buttons. To enter a two-digit number, be sure to press the two number buttons, one immediately after the other.

### 3 Press ▶II.

Playback starts in the programmed order.



- The program is cleared when the disc tray is opened or the power is turned off.
- Press RANDOM >X while program playback to enter random playback mode. When ▶II is pressed during random playback mode, the programmed tracks are played in random order.
- When REPEAT ↺ is pressed during program playback, the tracks are played repeatedly in the programmed order.

### ■ Checking the order of the programmed tracks

In the stop mode, press ▶II.

The tracks are shown in the programmed order in the display each time ▶II is pressed.

### ■ Clears the programmed tracks

In the stop mode, press CLEAR.

The last track programmed is cleared each time the button is pressed.



- You can also select a track to be cleared by pressing ▶II.

### ■ Clearing the all programmed track

In the stop mode, press PROGRAM.





## Playing files

- 1 Press **CD** to switch the input source to “CD”.
- 2 Load a CD-R or CD-RW containing music files into the disc tray. (👉 p. 143)
  - Press  $\triangle$  on the unit to open/close the disc tray.
- 3 Use **Cursor Up/Down** and **BACK** buttons to select the folder to be played, then press **ENTER**.
- 4 Use **Cursor Up/Down** buttons to select the file to be played, then press **ENTER**.  
Playback starts.

Operation buttons	Function
$\triangleright  $	Playback / Pause
$\square$	Stop
$\ll \gg$	Skip to previous track / Skip to next track (Press and hold) Fast-reverse / Fast-forward
<b>BACK</b>	Moving up a level in the hierarchy
<b>Cursor Up/Down</b>	Select the item
<b>ENTER</b>	Enter the selected item / Playback
<b>RANDOM</b> $\times$	Random playback
<b>REPEAT</b> $\hookrightarrow$	Repeat playback <ul style="list-style-type: none"> <li>• Switching between All-track repeat and Single-track repeat.</li> </ul>
<b>INFO</b>	Switches the display between Title name / Artist name, Title name / Album name and File name.
<b>OPTION</b>	Select the playback range



- To start playing another file during playback of a CD-R/CD-RW, first press **BACK** to display the file tree. Next, use **Cursor Up/Down** buttons to select the file to be played and press **ENTER**.



## ■ Switching the display

During playback, press INFO.

- Switches the display between Title name / Artist name, Title name / Album name and File name.
- If a file does not support text information or no track information is recorded, the file name is displayed.
- The player can display the following characters:

ABCDEFGHIJKLMNOPQRSTUVWXYZ

abcdefghijklmnopqrstuvwxyz

0123456789

! " # \$ % & ; : < > ? @ \ [ ] \_ ` | { } ~ ^ ' ( ) \* + , - . / = space

- Any characters that cannot be displayed are replaced with "." (period).

## ■ Files that can be played back

- See "Specifications of supported files" (📖 p. 139).

## ■ Switching the playback range

Press OPTION.

- The playback range of a track can be set.

**Folder mode:**

All the files in the selected folder are played.  is displayed on the display at this time.

**All mode:**

All the files in the disc are played.



## Playing digital input

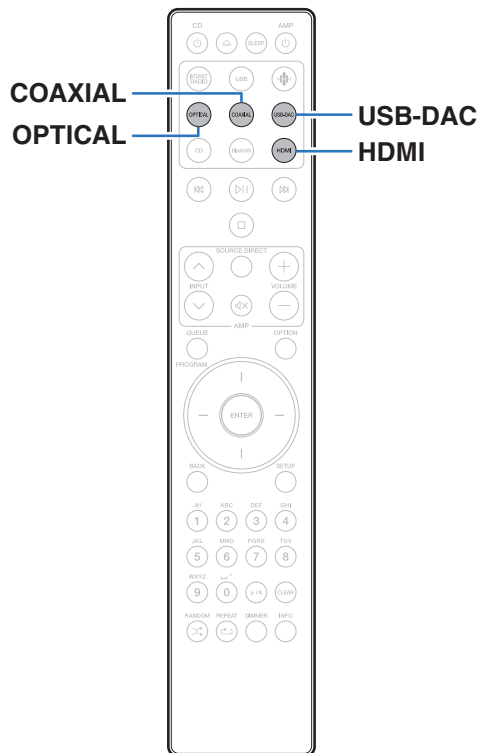

### Connecting and playing back from a TV or digital device (HDMI/Coaxial/Optical)

- 1 Prepare for playback.**  
Check the connection, then turn on this units. (“Connecting a TV” (🔗 p. 27), “Connecting to a device with digital audio output connectors” (🔗 p. 32))
- 2 Press HDMI, COAXIAL or OPTICAL to switch the input source to “HDMI”, “Coaxial” or “Optical”.**
- 3 Play the component connected to this unit.**
  - If the sampling frequency cannot be detected, “Signal Unlock” will be displayed.
  - “Unsupported” is displayed when audio signals that are not supported by this unit are input.





- When “TV Input” is set in the setup menu, this unit automatically turns on when the TV connected to the unit is turned on, and the input source switches to “HDMI”, “Coaxial” or “Optical”. (🔗 p. 107)
- If you connect your TV via the Optical or Coaxial connection, this unit cannot be put to standby when you turn off your TV. If you want to automatically put this device on standby, set “Auto-Standby” in the setup menu. (🔗 p. 109)

#### NOTE

- Do not input non-PCM signals, such as Dolby Digital, DTS and AAC. This causes noise and could damage the speakers.
- Only the PCM 2-channel setting can be used to play sound from a TV via the ARC function. Set “PCM 2ch” as the audio format in the TV settings.

## ■ Specifications of supported audio formats

See “Digital input” (🔗 p. 145).

## ■ HDMI control function

Connect this unit to a TV that supports the HDMI control function with an HDMI cable and enable the HDMI control setting on the TV to perform basic operations on this unit (changing the input source, turning the power on and off, adjusting the volume) with the remote control of the TV.

Refer to “About HDMI” (🔗 p. 148) for more information about the HDMI control function.



## Connecting and playing back from a computer (USB-DAC)

You can enjoy high-quality audio playback from the D/A converter built in to this unit by inputting music files into this unit from a computer via USB connection.

- Before USB connecting this unit to your computer, install the driver software in your computer.
- Drivers do not need to be installed for macOS.
- Also, you can use whichever commercially available or downloadable player software you like to playback files on your computer.

### ■ Computer (system requirements)

#### OS

- Windows 10 or Windows 11
- macOS 12 or 13

#### USB

- USB 2.0: USB High speed/USB Audio Class Ver. 2.0

#### NOTE

- This unit was checked the operation using the system requirements by us, but it does not guarantee the operation of all systems.

- DSD is a registered trademark.
- Microsoft, Windows 10 and Windows 11 are either registered trademarks or trademarks of Microsoft Corporation in the United States and/or other countries.
- ASIO is a trademark of Steinberg Media Technologies GmbH.
- Apple, Macintosh and macOS are trademarks of Apple Inc., registered in the U.S. and other countries.

**Windows OS** Installing the dedicated driver (👉 p. 79)

**macOS** Audio Device Settings (👉 p. 85)



## ■ Installing the dedicated driver (Windows OS only)

### □ Installing the driver software

- 1 Disconnect the USB cable between your PC and the unit.**
  - The driver software cannot be installed correctly if your PC is connected to the unit by a USB cable.
  - If the unit and your computer are connected by a USB cable and the computer is switched on before installation, disconnect the USB and restart the computer.
- 2 Download the dedicated driver from the “Download” section of the CD 50n page of the Marantz website onto your PC.**
- 3 Unzip the downloaded file, and double-click the exe file.**

## 4 Install the driver.

- ① Select the language to use for the installation.
- ② Click “OK”.

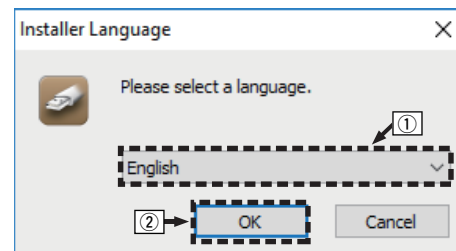

- ③ The wizard menu is displayed. Click “Next”.

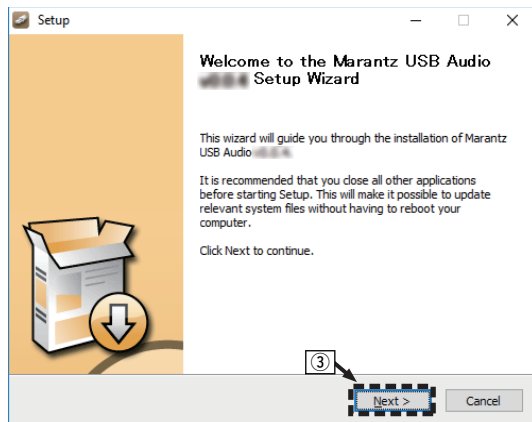

- ④ Read the Software Licensing Agreement, and click “I accept the terms of the License Agreement”.
- ⑤ Click “Next”.

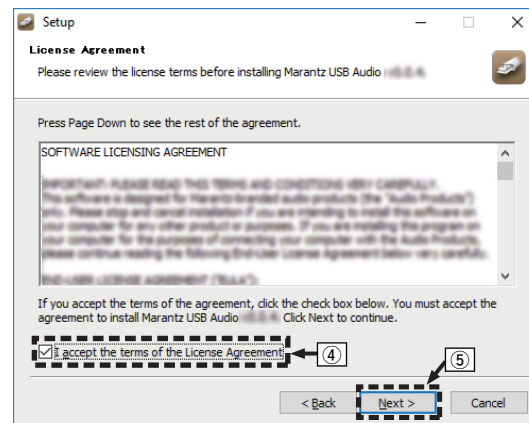

- ⑥ Click “Install” on the installation start dialog.
- The installation starts. Do not perform any operation on the PC until the installation is completed.

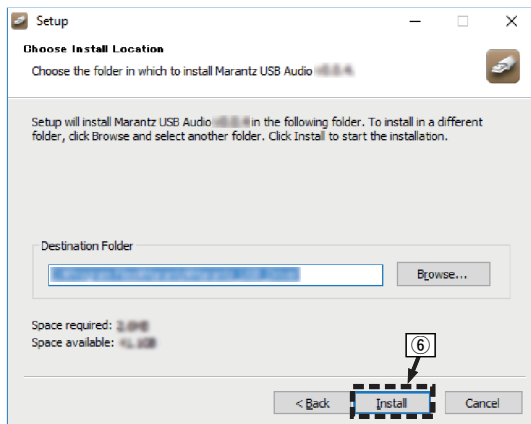

- ⑦ Click “Next”.

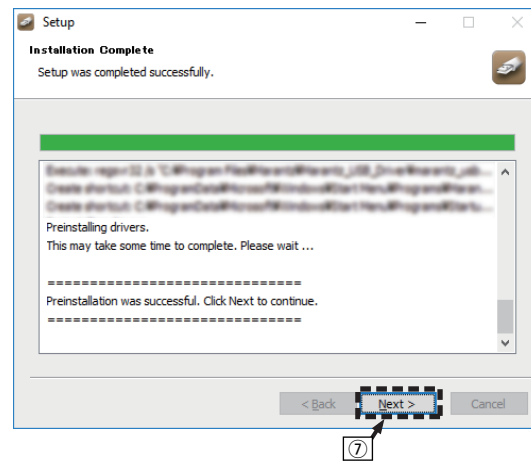

⑧ When the installation is completed, click “Finish”.

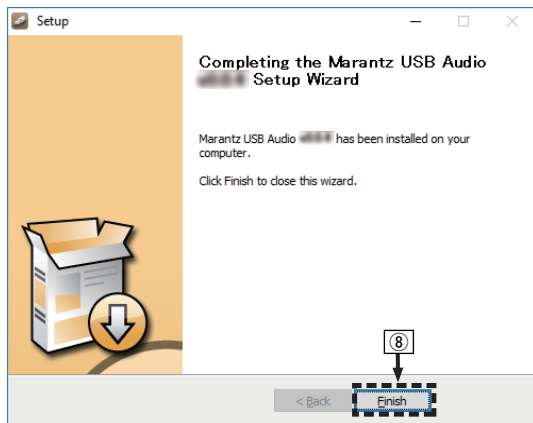

⑨ Click “Yes”.



## 5 With the unit power off, connect the unit and PC using a USB cable (not included).

- For details on connections, see “Connecting a PC or Mac” (📖 p. 33).



## 6 Press CD $\phi$ .

- When the unit power is turned on, the PC automatically finds and connects to the unit.

## 7 Press USB-DAC to switch the input source to “USB-DAC”.

## 8 Checking the installed driver.

- ① Open the “Control Panel” on the PC.
  - The control panel setting list is displayed.
- ② Click “Sound”.
  - The sound menu window is displayed.
- ③ Check that there is a checkmark next to “Default Device” under in “CD 50n” of the “Playback” tab.
  - When there is a checkmark for a different device, click “CD 50n” and “Set Default”.

## 9 Checking audio output.

Outputs a TEST signal from the PC and checks the audio output from the USB-DAC function.

- ① Select “CD 50n” and click “Properties”.
  - The Properties window is displayed.

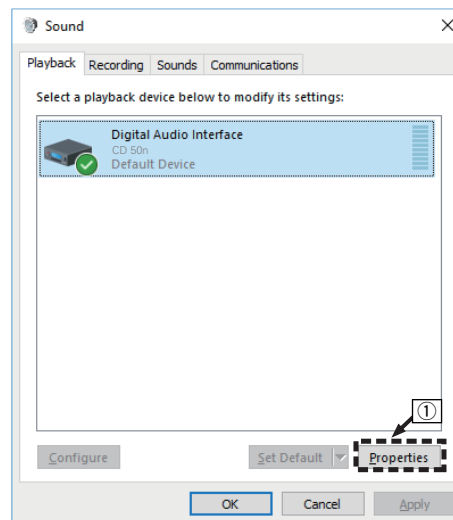

- ② Click the “Advanced” tab.
  - ③ Select the sampling rate and bit rate to be applied to the D/A converter.
    - It is recommended that “2 channel, 32 bit, 192000 Hz (Studio Quality)” is selected.
  - ④ Click “Apply”.
  - ⑤ Click “Test”.
- Check that audio from this unit is output from the PC.

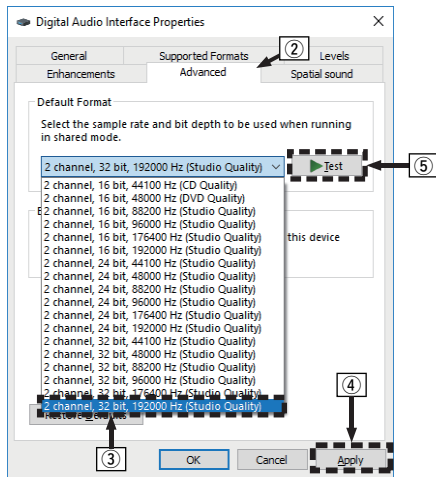

- The dedicated driver must be installed in the PC before this unit is connected to a PC. Operation will not occur correctly if connected to the PC before the dedicated driver has been installed.
- Operation may fail in some PC hardware and software configurations.
- Player software supporting the Audio Stream Input Output (ASIO) driver is required to play files with a sampling frequency of 352.8 kHz/384 kHz without downsampling. Check your player software before playing files with the ASIO driver.
- Please see the FAQ at [www.marantz.com](http://www.marantz.com) if you experience any issues getting audio to play from your computer through this unit. You may also want to check the support pages for your audio player application.



## ■ Audio Device Settings (macOS only)

- ① With the unit power off, connect the unit and Mac using a USB cable (not included).
  - For the connection procedure, refer to the “Connecting a PC or Mac” section. (👉 p. 33)
- ② Press CD  $\phi$ .
- ③ Press USB-DAC to switch the input source to “USB-DAC”.
- ④ Move the cursor to “Go” on the computer screen, and then click “Utilities”.
  - The utility list is displayed.
- ⑤ Double-click “Audio MIDI Setup”.
  - The “Audio Devices” window is displayed.
- ⑥ Secondary click on “CD 50n”, and then check that “Use This Device For Sound Output” is checked.
  - If a different device is checked, select and secondary click on “CD 50n”, and then select “Use This Device For Sound Output”.

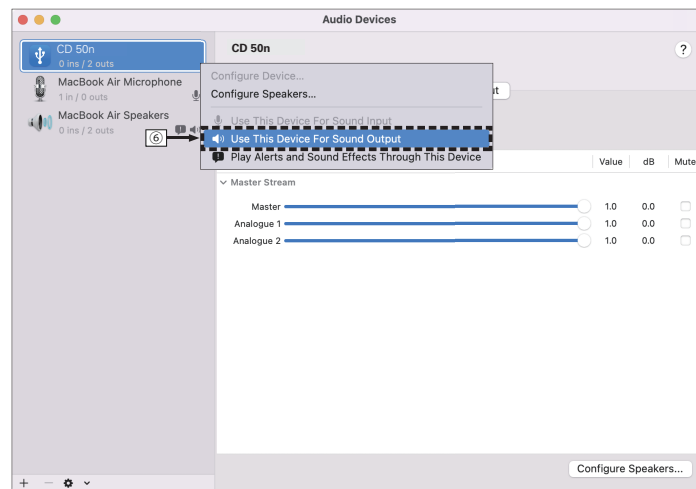



## AirPlay function

Music files stored on your iPhone, iPod touch, iPad or iTunes can be played on this unit via the network.



- Input source will be switched to “AirPlay” when AirPlay playback is started.
- You can stop AirPlay playback by choosing other input source.
- For information about how to use iTunes, also see the Help for iTunes.
- The screen may differ depending on the OS and software versions.

### NOTE

- In playback using the AirPlay function, the sound is output at the iPhone, iPod touch, iPad or iTunes volume setting level.  
You should turn down the iPhone, iPod touch, iPad or iTunes volume prior to playback and then adjust it to a suitable level.

### This device supports AirPlay 2.

Sync multiple AirPlay 2 compatible devices/speakers for simultaneous playback.



- This unit supports AirPlay 2 and requires iOS 11.4 or later.

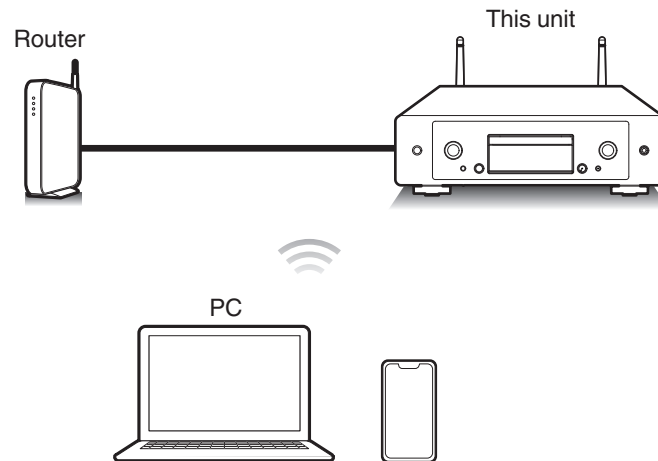

## Playing songs from your iPhone, iPod touch or iPad

If you update your “iPhone/iPod touch/iPad” to iOS 10.0.2 or later, you can stream music stored in your “iPhone/iPod touch/iPad” directly to this unit.

### 1 Connect your iPhone, iPod touch or iPad Wi-Fi to the same network as this unit.

- For details, see your device’s manual.

### 2 Play the song on your iPhone, iPod touch or iPad.

AirPlay icon is displayed on the iPhone, iPod touch or iPad screen.

### 3 Tap the AirPlay icon and select this unit.

[Example] iOS 15

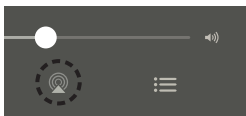

[Example] iOS 10



## Playing iTunes music with this unit

### 1 Install iTunes 10, or later, on a Mac or Windows PC that is connected to the same network as this unit.

### 2 Start iTunes and click the AirPlay icon to select this unit.

[Example] iTunes

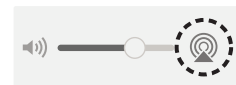

### 3 Choose a song and click play in iTunes.

The music will stream to this unit.



- When “Network Control” is set to “On”, you can turn on this unit by operating iTunes. (☞ p. 113)



## Play a song from your iPhone, iPod touch or iPad on multiple synced devices (AirPlay 2)

Songs from an iPhone, iPod touch or iPad operating iOS 11.4 or later can be synced with multiple AirPlay 2 supported devices for simultaneous playback.

### 1 Play the song on your iPhone, iPod touch or iPad.

AirPlay icon is displayed on the iPhone, iPod touch or iPad screen.

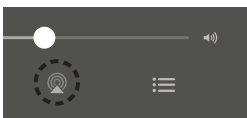

### 2 Tap the AirPlay icon and select this unit.

Displays a list of devices/speakers that can be played back on the same network.

- A circle is displayed to the right of AirPlay 2 compatible devices.

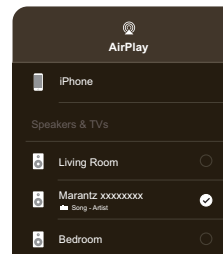

### 3 Tap the devices/speakers you want to use.

- Multiple AirPlay 2 compatible devices can be selected.

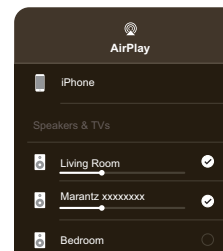

## Spotify Connect function

Spotify is all the music you'll ever need. Millions of songs available instantly. Just search for the music you love, or let Spotify play you something great. Spotify works on your phone, tablet, computer and home speakers. So you'll always have the perfect soundtrack for whatever you're doing. Now you can enjoy Spotify with your free account as well as Premium account.

Use your phone, tablet or computer as a remote control for Spotify.

Go to [www.spotify.com/connect](http://www.spotify.com/connect) to learn how.

The Spotify software is subject to third party licenses found here:

[www.spotify.com/connect/third-party-licenses](http://www.spotify.com/connect/third-party-licenses)

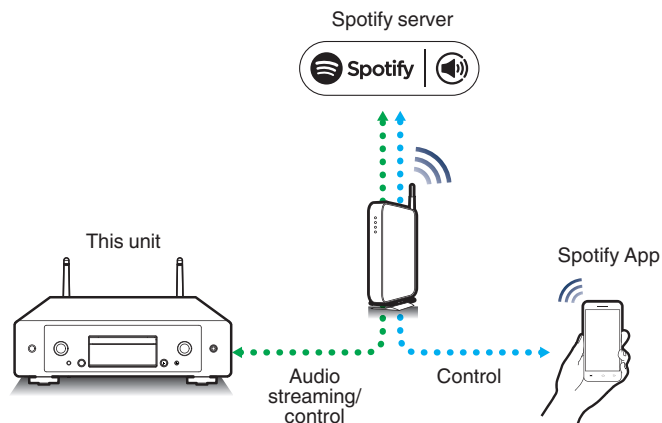

### Playing Spotify music with this unit

Download the "Spotify App" onto your iOS or Android device beforehand.

- 1** Connect the Wi-Fi settings of the iOS or Android device in the same network as this unit.
- 2** Launch the Spotify App.
- 3** Play back the Spotify track.
- 4** Tap the Spotify icon  to select the unit.

The music will stream to this unit.



## Convenience functions

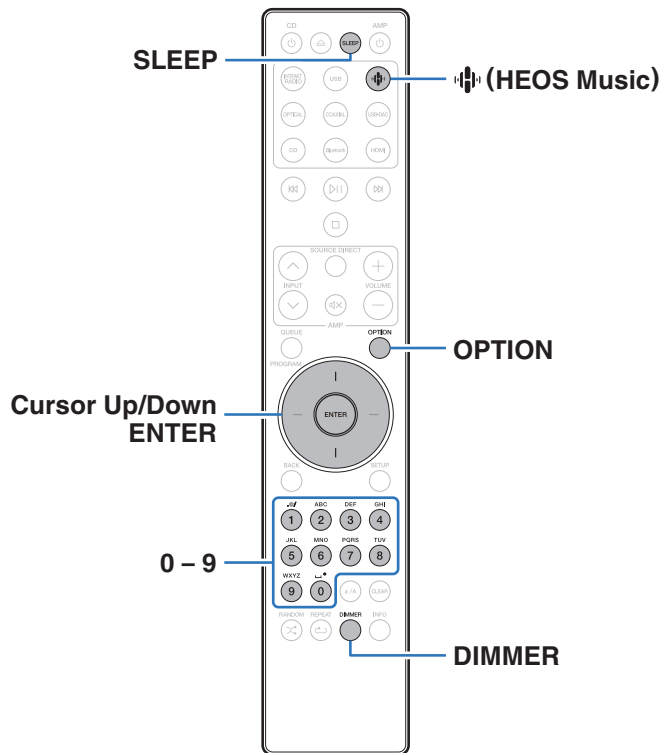

- This section explains how to use convenient functions that can be used for each input source.
- Control of “HEOS Favorites” operations is optimized for the app. For more information on acquiring the app, see “Getting the HEOS app” (📖 p. 59).



## Playing back HEOS Favorites

When using the HEOS Favorites function for the first time on this unit, create a HEOS Account on the HEOS app or sign in to your account. Once you create or sign into your HEOS Account, you can use the HEOS Favorites feature to save and recall your favorite streaming radio stations using this unit.

### 1 Press **0** (HEOS Music).

If a playback history is present, the last Internet radio station or song played is played back. Pressing **0** (HEOS Music) again displays the HEOS Music top menu.

### 2 Use Cursor Up/Down buttons to select “Favorites”, then press ENTER.

### 3 Use Cursor Up/Down buttons to select the content you would like to playback, then press ENTER.

### 4 Use Cursor Up/Down buttons to select “Play Now”, then press ENTER.



- You can select content you would like to playback from your HEOS Favorites by pressing 0-9.
- You can no longer select Favorites from the HEOS Music top menu when this unit is not synced with a HEOS Account in the HEOS app.

## Adding to HEOS Favorites

This function only works for streamed content.

### 1 While content is playing, press **OPTION**.



The option menu screen is displayed.

### 2 Use Cursor Up/Down buttons to select “Add to HEOS Favorites”, then press ENTER.

### 3 Use Cursor Up/Down buttons to select the “HEOS Favorites” number you would like to save your contents to, then press ENTER.



## Deleting a HEOS Favorites

- 1 Press  (HEOS Music).**  
If a playback history is present, the last Internet radio station or song played is played back. Pressing  (HEOS Music) again displays the HEOS Music top menu.
- 2 Use Cursor Up/Down buttons to select “Favorites”, then press ENTER.**
- 3 While the HEOS Favorites content list is displayed, use Cursor Up/Down buttons to select the item you want to remove from HEOS Favorites, then press ENTER.**
- 4 Use Cursor Up/Down buttons to select “Remove from HEOS Favorites”, then press ENTER.**

## Switching the display's brightness

The display brightness can be adjusted between four levels. Switching the display off reduces a source of noise that affects sound quality, enabling higher sound quality playback.

- 1 Press DIMMER.**
  - The brightness of the display switches each time the button is pressed.



- If buttons are operated when the display is off, information is temporarily displayed at the brightest setting.
- The display brightness is set to most brightly by default.
- DIMMER also works with the Marantz amplifier MODEL 50 (not included) and the brightness can be adjusted simultaneously when used in conjunction with this unit. If the brightness settings differ, set the brightness of each to the brightest setting by pressing DIMMER for 5 seconds or more before adjusting.



## Using the sleep timer

You can have the power automatically switched to standby once a set time has elapsed. This is convenient for listening while going to sleep.

### 1 Press SLEEP during playback and select the setting time.

- The  indicator on the display lights.
- The sleep timer can be set to up to 90 minutes, in steps of 10 minutes.
- After about 5 seconds, the setting is entered and the display returns to as it was before.

### ■ To cancel the sleep timer

#### 1 Press SLEEP to set “Sleep ► Off”.

The  indicator on the display turns off.



- The sleep timer setting is canceled when the unit switches to standby mode.
- To check the time remaining until the sleep timer is activated, press SLEEP.



## Menu map

For menu operations, see the following page.

By default, this unit has recommended settings defined. You can customize this unit based on your existing system and your preferences.

Setting items	Detailed items	Description	Page
Audio	<b>Filter</b>	This unit is equipped with a sound quality adjusting function which allows users to enjoy the desired playback sound quality.	101
	<b>Lock Range</b>	Narrowing down the “Lock Range” setting reduces jittering, providing clearer sound.	101
	<b>Line Out Level</b>	Set according to the terminal (VARIABLE or FIXED) where the amplifier is connected.	102
	<b>Variable Out</b>	You can stop the circuit that outputs audio from the analog audio output terminals (VARIABLE) of this unit. This prevents the audio signal output from the analog audio output terminals (FIXED) from being affected.	104
	<b>Volume Limit</b>	Make a setting for maximum volume. The volume cannot be increased above this setting.	105
	<b>Digital Out</b>	Stopping digital audio output reduces a source of noise that affects sound quality, enabling higher sound quality playback.	105
	<b>H/P Amplifier Gain</b>	Set the gain of the headphone amplifier. By setting according to the impedance of your headphone, you can enjoy playing headphones at an appropriate volume.	106
TV	<b>TV Input</b>	Set this when playing audio from a TV on this unit.	107
	<b>HDMI Power Off Control</b>	Set the “HDMI Power Off Control” function that is keyed to the power off operation of your TV to turn the device’s power to standby.	108



Setting items	Detailed items	Description/Detailed items	Page
General	<b>Language</b>	Sets the language for display the menu.	109
	<b>Auto-Standby</b>	Sets the unit power to standby when the unit is not in use.	109
	<b>Power Sync</b>	Sets the "Power Sync" function, which links the powering on of Marantz amplifiers connected to this unit to the powering on of this unit, turning them on when power on operations are performed on this unit.	110
	<b>Information</b>	Displays notifications. Also, sets whether or not to display the notification when the power is turned on.	110
		<b>Notification Alerts</b>	110
		<b>Check for Notifications</b>	110
	<b>Reset</b>	Various settings are reset to the factory default values.	110
Network	<b>Network Information</b>	Displays various information about the network.	111
	<b>Network &amp; USB-A</b>	The network and USB flash drive playback (USB-A) functions can be stopped to prevent noise that affects the sound quality.	111
	<b>Wi-Fi</b>	The Wi-Fi function can be stopped to prevent noise that affects the sound quality.	111
	<b>Bluetooth</b>	Stopping Bluetooth function reduces a source of noise that affects sound quality, enabling higher sound quality playback. It also sets the Bluetooth transmitter settings.	112
	<b>Network Control</b>	Performs the on/off settings for the network function when in standby mode.	113
	<b>AirPlay Setup</b>	Set this unit to WAC mode. Perform this setup when connecting to a network using an iOS device.	113



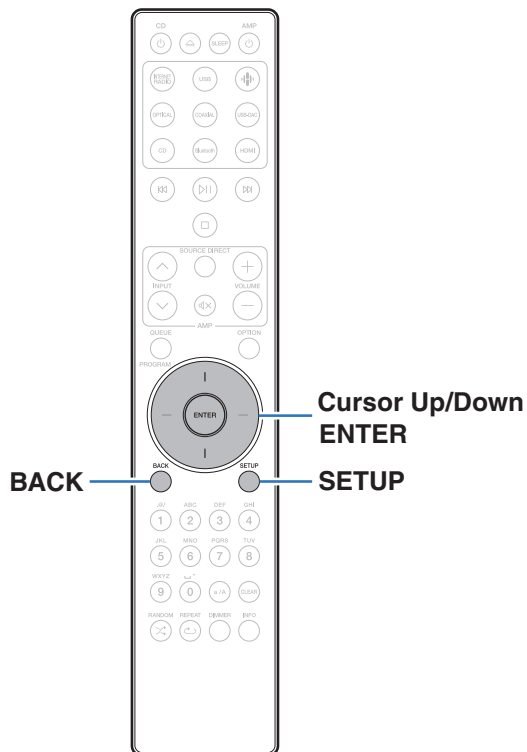

## Menu operation

- 1 Press SETUP.**  
The setup menu is displayed on the display.
- 2 Use Cursor Up/Down buttons to select the setup menu to be set or operated, then press ENTER.**
- 3 Use Cursor Up/Down buttons to change to desired setting.**
- 4 Press ENTER to enter the setting.**
  - To return to the previous item, press BACK.
  - Exiting the setup menu, press SETUP while the setup menu is displayed. The display returns to the normal display.



# Inputting characters

## Using the number buttons

- 1 **Display the screen for inputting characters.**
  - To change a character, use Cursor Left/Right buttons to align the cursor with the character that you want to change.
- 2 **Press a/A to select the character type (upper case, lower case, characters with diacritical marks or numeric characters).**

### 3 Use 0 – 9 until the desired character is displayed.

- The types of characters that can be input are as shown in the following table.

1 ●	1 . @ - _ / :
2 ABC	a b c A B C 2 ä à á â ã ä å æ ç ç Ä Å Á Â Ã Ä Æ É Ç Ć
3 DEF	d e f D E F 3 ð ë è é ê Ë Ì Í Î Ï
4 GHI	g h i G H I 4 ï ï ï ï ï ï ï
5 JKL	j k l J K L 5
6 MNO	m n o M N O 6 ñ õ ö ó ô õ ø Ñ Ò Ó Ô Õ Ö Ø
7 PQRS	p q r s P Q R S 7 B ř ŕ ś š ŝ ß Ŕ Ŗ Ś Ŝ Š
8 TUV	t u v T U V 8 ü ú ú ú Ü Û Ú Û
9 WXYZ	w x y z W X Y Z 9 ý ź ż þ Þ Ý Ž Ž Þ
0 ◌	0 (Space) ! " # \$ % & ' ( ) * + , ; < = > ? [ \ ] ^ _ {   } ¡ ¢ £ ¤ ¥ © « ¬ ° ± » ¿





### 3 Repeat step 2 to input characters then press ENTER to register it.



- Press CLEAR to erase the character that is currently selected.
- Press and hold CLEAR for 3 seconds or more to erase all characters.
- Press  $\text{N}$  to insert a space.



# Audio

Make audio-related settings.

## Filter

This unit is equipped with a sound quality adjusting function which allows users to enjoy the desired playback sound quality. The unit supports PCM signal.

### Filter 1 (Default):

Offers a short impulse response for both pre-echo and post-echo. Large amount of audio information clearly reproduces deep stereo imaging and the relative position of the sound source.

### Filter 2:

This characteristic is known as asymmetrical impulse response. The post echo is slightly longer than the pre-echo. The sound characteristics is more analog like.

## Lock Range

Narrowing down the “Lock Range” setting reduces jittering, providing clearer sound. However, if the “Lock Range” is set too narrow, it may cause intermittent sounds and noise during playback or when switching to a song with a different sampling frequency. If this occurs, broaden the “Lock Range” setting until the music you are listening to sounds normal.

### Narrow / Medium / Wide



- The factory default setting for “Lock Range” differs depending on the input source. Below are the factory default settings for each input source.

Default	Input source
Narrow	CD
Wide	HEOS Music / Bluetooth / USB flash drive playback (USB-A) / USB-DAC / HDMI / Coaxial / Optical

- A separate “Lock Range” setting is recorded for each input source, except for “HEOS Music”, USB flash drive and Bluetooth, which have a common setting.



## Line Out Level

Set according to the terminal (VARIABLE or FIXED) where the amplifier is connected. Use this setting when connecting a Marantz amplifier to this unit using remote control connection. (🔗 p. 38)

### Variable:

When the “Power Sync” function is used, the input source of the Marantz amplifier switches to “POWER AMP”. Control the volume of the audio signal output from this unit’s analog audio output terminals (VARIABLE) with the HEOS app or TV remote control unit (HDMI control function).

### Fixed (Default):

When the “Power Sync” function is used, the input source of the Marantz amplifier switches to “CD”. Control the volume of the Marantz amplifier connected to this unit with the HEOS app or TV remote control unit (HDMI control function).

### Custom:

You can set “Variable” or “Fixed” for each input source (HDMI/HEOS/Bluetooth). Other input sources are set to “Fixed”.

## ■ Custom

Set the terminal (VARIABLE or FIXED) to which the amplifier will connect for each input source (HDMI/HEOS/Bluetooth). If the input source is a CD, USB-DAC, Coaxial, or Optical, the analog audio output terminal (FIXED) will be used.

For example, if you set “HDMI” to “Variable”, when listening to CDs, the volume of the amplifier can be adjusted with the VOLUME + and – buttons on the remote control, and when watching TV via HDMI ARC, the volume of the unit can be comfortably adjusted with the TV remote control.



## ❑ HDMI

Set the analog audio output terminal to be used when playing the input source of the unit to HDMI.

### Variable (Default):

When the “Power Sync” function is used, the input source of the Marantz amplifier switches to “POWER AMP” when the input source is started with HDMI or when the input source of the unit is switched to HDMI. Adjust the volume of the audio signal output from the unit’s analog audio output terminal (VARIABLE) with the HEOS app or TV remote control (HDMI control function).

### Fixed:

When the “Power Sync” function is used, the input source of the Marantz amplifier switches to “CD” when the input source is started with HDMI or when the input source of the unit is switched to HDMI. Adjust the volume of the Marantz amplifier connected to the unit with the HEOS app or TV remote control (HDMI control function).

## ❑ HEOS

Set the analog audio output terminal to be used when playing the input source of the unit to HEOS.

### Variable:

When the “Power Sync” function is used, the input source of the Marantz amplifier switches to “POWER AMP” when the input source is started with HEOS or when the input source of the unit is switched to HEOS. Adjust the volume of the audio signal output from the unit’s analog audio output terminal (VARIABLE) with the HEOS app or TV remote control (HDMI control function).

### Fixed (Default):

When the “Power Sync” function is used, the input source of the Marantz amplifier switches to “CD” when the input source is started with HEOS or when the input source of the unit is switched to HEOS. Adjust the volume of the Marantz amplifier connected to the unit with the HEOS app or TV remote control (HDMI control function).



## Bluetooth

Set the analog audio output terminal to be used when playing the input source of the unit to Bluetooth.

**Variable:** When the “Power Sync” function is used, the input source of the Marantz amplifier switches to “POWER AMP” when the input source is started with Bluetooth or when the input source of the unit is switched to Bluetooth. Adjust the volume of the audio signal output from the unit’s analog audio output terminal (VARIABLE) with the HEOS app or TV remote control (HDMI control function).

**Fixed (Default):** When the “Power Sync” function is used, the input source of the Marantz amplifier switches to “CD” when the input source is started with Bluetooth or when the input source of the unit is switched to Bluetooth. Adjust the volume of the Marantz amplifier connected to the unit with the HEOS app or TV remote control (HDMI control function).



- Some operations may not be possible on some Marantz amplifiers.
- It may not be possible to control the volume with the TV remote control (HDMI control function) depending on the Marantz amplifier and TV connected to this unit.

## Variable Out

You can stop the circuit that outputs audio from the analog audio output terminals (VARIABLE) of this unit. This prevents the audio signal output from the analog audio output terminals (FIXED) from being affected. If you will not use the analog audio output terminals (VARIABLE), turning this setting off enables a higher quality of sound.

**On**  
(Default): Enables variable audio output.

**Off:** Disables variable audio output.



## Volume Limit

Make a setting for maximum volume. The volume cannot be increased above this setting.

<b>Off</b> (Default):	Do not set a maximum volume. (100 (+6dB))
--------------------------	--

**40 - 95 (-54 dB - +1 dB)**

## Digital Out

Stopping digital audio output reduces a source of noise that affects sound quality, enabling higher sound quality playback.

<b>On</b> (Default):	Digital audio output is enabled.
-------------------------	----------------------------------

<b>Off:</b>	Digital audio output is disabled.
-------------	-----------------------------------



## H/P Amplifier Gain

Set the gain of the headphone amplifier. Set this according to the impedance of the connected headphones. It is recommended that this is set on the “Low” side if the headphones have low impedance and on the “High” side if they have high impedance.

<b>High:</b>	Set the gain of the headphone amplifier to “High”. Set this if the volume is too low at the factory default setting.
<b>Mid (Default):</b>	Set the gain of the headphone amplifier to “Mid”.
<b>Low:</b>	Set the gain of the headphone amplifier to “Low”. Set this if the volume is too high at the factory default setting.

### NOTE

- The headphone volume varies depending on the H/P Amplifier Gain setting. Decrease the volume or mute the audio first if changing this setting while listening to audio.



# TV

## TV Input

Set this when playing audio from a TV on this unit. When the TV is turned on, this unit turns on and the input source is automatically switched to "HDMI", "Optical" or "Coaxial" so that the audio from the TV can be played through this unit.

### ■ Default Input

Set the input source to be used when playing audio from the TV through this unit. Set this according to the jack on this unit being used to connect to the TV (HDMI ARC, OPTICAL input or COAXIAL input).

**None / HDMI Out (ARC) / Optical In / Coaxial In**  
(Default: HDMI Out (ARC))

### ■ Auto-Play

When a TV audio source is input to this unit, the unit automatically switches to the input source set in "Default Input" and the Auto-Play function for playing TV audio on this unit is set.

---

**On**  
(Default): Enables the Auto-Play function.

---

**Off:** Disables the Auto-Play function.

---



- The Auto-Play function does not work when "Default Input" is set to "None". Set "Default Input" in advance.
- The Auto-Play function will not work if the sampling frequency of the audio signal input from this unit's OPTICAL input terminal and COAXIAL input terminal is 88.2 kHz or more. TVs normally output 48 kHz audio signals and the Auto-Play function will work, but if you connect a device that outputs an audio signal of 88.2 kHz or more and try to use it, the Auto-Play function may not work.



## HDMI Power Off Control

Set the “HDMI Power Off Control” function that is keyed to the power off operation of your HDMI connected TV to turn the device's power to standby.

<b>All</b> (Default) :	Regardless of the input source of this device, if the power of the TV is turned off, the power of this device automatically becomes standby.
<b>HDMI ARC:</b>	If the input source is HDMI and you power off the TV, the power of this device automatically becomes standby.
<b>Off:</b>	This unit is not linked to the power of the TV.



## General

---

### Language

Sets the language for display the menu.

**English / Français / Español** (Default : English)

### Auto-Standby

Sets the amount of time that must elapse without unit operation or an input signal before the unit goes into standby automatically.

<b>Off</b> (Default):	The unit does not go into standby automatically.
<b>1min:</b>	The unit goes into standby after 1 minutes.
<b>5min:</b>	The unit goes into standby after 5 minutes.
<b>15min:</b>	The unit goes into standby after 15 minutes.
<b>Other:</b>	Sets the minutes (between 1 and 99) before the unit automatically goes into standby. After setting the amount of time with 0 – 9 buttons, press ENTER to confirm the setting.



## Power Sync

Sets the “Power Sync” function, which synchronizes the powering on of Marantz amplifiers connected to this unit to the powering on of this unit, turning them on when power on operations are performed on this unit.

<b>On</b> (Default):	Power on is synchronized.
<b>Off:</b>	Power on is not synchronized.

## Information

### ■ Notification Alerts

Sets whether or not to display the notification when the power is turned on.

<b>On</b> (Default):	Notification messages are displayed.
<b>Off:</b>	Notification messages are not displayed.

### ■ Check for Notifications

Displays notifications.

## Reset

Perform this procedure if the display is abnormal or if operations cannot be performed. Restores the contents of each setting to the factory settings. Make settings again.

<b>Reset factory defaults:</b>	Unit is initialized.
<b>Cancel:</b>	Unit is not initialized.



# Network

## Network Information

Displays network information.

---

**Friendly Name / Connection / SSID / DHCP / IP Address / MAC Address (Ethernet) / MAC Address (Wi-Fi)**

---

## Network & USB-A

The network and USB flash drive playback (USB-A) functions can be stopped to prevent noise that affects the sound quality. This enables playback with a high sound quality when using the CD playback and D/A converter functions.

---

**On**  
(Default): Enables the network and USB flash drive playback (USB-A) function.

---

**Off:** Disables the network and USB flash drive playback (USB-A) function.

---

## Wi-Fi

The Wi-Fi function can be stopped to prevent noise that affects the sound quality. Using a wired LAN to connect this unit to the network enables playback with a high sound quality.

---

**On**  
(Default): Enables the Wi-Fi function.

---

**Off:** Disables the Wi-Fi function.

---



## Bluetooth

### Bluetooth

Stopping Bluetooth receiver and transmitter functions reduces a source of noise that affects sound quality, enabling higher sound quality playback.

<b>On</b> (Default):	Enables the Bluetooth function.
<b>Off:</b>	Disables the Bluetooth function.

### Headphone

Enables or disables the Bluetooth headphones transmitter. Perform these settings when you are listening to audio playback of this unit with Bluetooth headphones.

<b>On</b>	Enables the Bluetooth headphones transmitter feature.
<b>Off</b> (Default):	Disables the Bluetooth headphones transmitter feature.

### Devices

- Available devices are displayed in the list once you start pairing mode on the Bluetooth headphones you want to connect. Select your Bluetooth headphones from the list to pair them.
- This unit can only pair with one Bluetooth headphone at a time. However, up to 8 Bluetooth headphones can be registered. Switch between registered devices from “Devices” in the “Bluetooth” setup menu.
- To remove a saved Bluetooth device from the list, use the cursor Up/Down buttons to select it, then press the OPTION button and select “Forget This Device”.



- A2DP profile-compatible Bluetooth speakers can be connected following the same steps used to connect Bluetooth headphones.

#### NOTE

- Bluetooth transmitter and Bluetooth receiver function cannot be used at the same time. Bluetooth transmitter function is not available when listening to music on a Bluetooth device.
- Even when “Headphone” is set to “On”, press Bluetooth on the remote control to select the “Bluetooth” source and enable the Bluetooth receiver function. To listen to music stored on Bluetooth devices such as smartphones on this unit, press Bluetooth on the remote control to switch the input source to Bluetooth, then reconnect the Bluetooth device.
- Menu settings for Bluetooth headphones transmitter are not available when this unit is grouped within the HEOS app.
- Bluetooth headphones cannot be connected if a HEOS Built-in device is playing an input source from this unit.



## Network Control

Enables network communication in standby power mode.

<b>On</b> (Default):	Network is on during standby. Main unit operable with a network compatible controller.
<b>Off:</b>	Suspend network function during standby.



- When using the HEOS app, use with the “Network Control” setting set to “On”.

### NOTE

- When “Network Control” is set to “On”, the unit consumes more standby power.

## AirPlay Setup

This unit supports the “WAC (Wireless Accessory Configuration)” setup mode of Apple Inc. In the WAC setup mode, use your iOS device (iPhone/iPod/iPad) to connect to the network. By connecting your iOS device with this unit, this unit can be automatically connected to the same network.

1. Select “AirPlay Setup” and press ENTER.
  - This unit switches to the WAC setup mode.
2. At the bottom of the Wi-Fi setup screen for iOS devices, select “Marantz CD 50n” from “SET UP NEW AIRPLAY SPEAKER...”.
  - Make sure the iOS device is connected to the wireless LAN (Wi-Fi) router.
3. Select a network to connect this device and press “Next”.
4. Follow the on-screen instructions to complete the connection.
  - When connected, “Connected” is shown on the display.

### NOTE

- The firmware version of your iOS device must support iOS 10.0.2 or later.
- The WAC setup mode lasts approximately 15 minutes. If the setup is not completed within 15 minutes, the WAC setup mode is canceled automatically. If you cancel the WAC setup mode manually, press the BACK button.



## Connecting to the network by using the WPS button on the router

---

If you are using a wireless router that supports WPS (Wi-Fi Protected Setup™), connect to the network with the “push button method”. (Wi-Fi Protected Setup™ is trademarks of Wi-Fi Alliance.)

- 1 Press the WPS button on your router.**
- 2 Within 2 minutes, press and hold the CONNECT button on the rear panel for 5 seconds.**

“WPS Connecting” is shown on the display and the connection is started.

- When connected, “WPS Connected” is shown on the display.



- You can also press and hold  (HEOS Music) on the remote control for 5 seconds to enter WPS setup mode.



## Switching the function of the volume buttons on the remote control

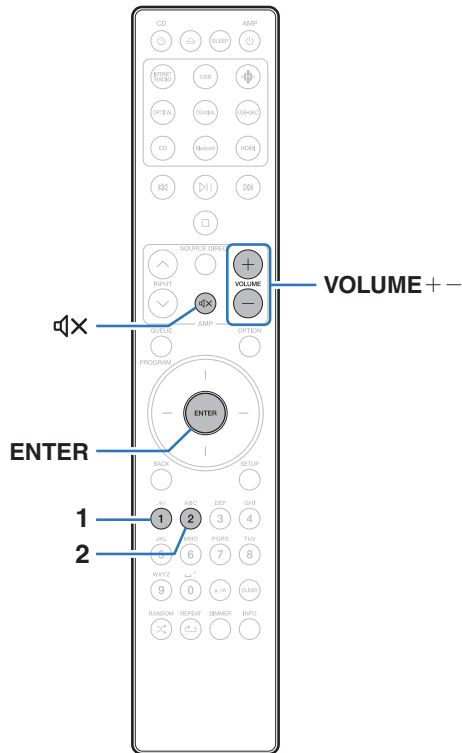

If connecting a power amplifier to the analog audio output terminals (VARIABLE) of this unit, you can change the operation mode of the included remote control so that the volume of the power amplifier can be adjusted from this unit. There are two remote control operation modes: amplifier operation mode and network CD player operation mode. Amplifier operation mode adjusts the volume of a Marantz amplifier and network CD player operation mode adjusts the volume of the audio signal output from the analog audio output terminals (VARIABLE) of this unit. The factory default setting for the remote control operation mode is the amplifier operation mode.



- Be sure to check the operation of each unit after setting the remote control operation modes.
- Switch between the remote control operation mode settings by pressing the VOLUME + - and MUTE buttons.
- The remote control operation modes returns to the default settings when the batteries are removed. Set the remote control operation modes again after replacing the batteries.



## Setting the remote control operation mode to network CD player operation mode

- 1 Press and hold the ENTER and number 2 button on the remote control unit down together for more than 5 seconds.



- “Variable Out” in the menu must also be set to “On” to adjust the volume of the audio signal output from the analog audio output connectors (VARIABLE). (☞ p. 104)

## Setting the remote control operation mode to amplifier operation mode

- 1 Press and hold the ENTER and number 1 button on the remote control unit down together for more than 5 seconds.



## ■ Contents

### Tips

I want to switch the filter to change the desired sound quality	118
I want to enjoy analog output audio at higher quality	118
I want to listen to high sound performance playback	118
I want to play TV audio at higher quality	118
I want to prevent this unit from going into standby by linking to the power off operation of an HDMI connected TV	119
Simple operations in the power off state	119
I want to connect a power amplifier to this unit	119
I want the volume not to become too loud by mistake	119

### Troubleshooting

Power does not turn on/Power is turned off	121
Operations cannot be performed through the remote control unit	122
Display on this unit shows nothing	122
No sound comes out	123
Sound is interrupted or noise occurs	124
Desired sound does not come out	125
AirPlay cannot be played back	126
USB flash drives cannot be played back	127
Bluetooth cannot be played back	128
The Internet radio cannot be played back	130
Music files on PC or NAS cannot be played back (Music server)	131
Various online services cannot be played	132
Cannot connect to a wireless LAN network	132
Cannot playback Discs	133
Music files on PC or Mac cannot be played back (USB-DAC)	134
Audio from digital devices cannot be played back (HDMI ARC/Coaxial/Optical)	135
The input source switches to "HDMI", "Optical" or "Coaxial"	135
The HDMI control function does not work	135
Update/upgrade error messages	136



# Tips

---

## I want to switch the filter to change the desired sound quality

- Switch the filter characteristics. (👉 p. 101)

## I want to enjoy analog output audio at higher quality

- Set “Digital Out” on the setup menu to “Off”. (👉 p. 105)
- Press the DIMMER button to turn the display off. (👉 p. 93)

## I want to listen to high sound performance playback

- The network and USB flash drive playback (USB-A) functions can be stopped to prevent noise that affects the sound quality. Set “Network & USB-A” to “Off” in the menu. (👉 p. 111)
- The Wi-Fi function can be stopped to prevent noise that affects the sound quality. Set “Wi-Fi” to “Off” in the setup menu. (👉 p. 111)
- Stopping Bluetooth function reduces a source of noise that affects sound quality, enabling higher sound quality playback. Set “Bluetooth” to “Off” in the setup menu. (👉 p. 112)
- You can stop the circuit that outputs audio from the analog audio output terminals (VARIABLE) of this unit. This prevents the audio signal output from the analog audio output terminals (FIXED) from being affected. Set “Variable Out” to “Off” in the setup menu. (👉 p. 104)

## I want to play TV audio at higher quality

- Connect the HDMI terminal of your TV that supports the ARC function to the HDMI ARC terminal of this unit and switch the input source to HDMI. (👉 p. 27)
- If you are using a TV that does not support the ARC function or a TV that does not have an HDMI terminal, the TV audio can be played by this unit using an Optical or Coaxial connection. (👉 p. 29)
- Only 2-channel linear PCM can be input as the digital audio signal to this unit.



**I want to prevent this unit from going into standby by linking to the power off operation of an HDMI connected TV**

- Change the “HDMI Power Off Control” setting to “Off”. (👉 p. 108)

**Simple operations in the power off state**

- Press the **▶||** button to automatically turn the unit’s power supply on and start playback of the last selected input source.
- When the “Network Control” function is set to “On”, you can perform playback, or other operations through AirPlay or HEOS app. (👉 p. 113)

**I want to connect a power amplifier to this unit**

- A power amplifier can be connected to the analog audio output connectors (VARIABLE) on the rear panel. Set “Variable Out” to “On” in the setup menu. (👉 p. 104)
- Set the remote control operation mode of the volume buttons on the remote control to network CD player operation mode to adjust the volume of the audio signal output from the analog audio output connectors (VARIABLE) using the remote control. (👉 p. 115)
- Set “Line Out Level” to “Variable” or “Custom” in the setup menu to adjust the volume of the audio signal output from the analog audio output connectors (VARIABLE) using the TV remote control (HDMI control function) and HEOS app. (👉 p. 102)

**I want the volume not to become too loud by mistake**

- Set the volume upper limit for “Volume Limit” in the menu beforehand. This prevents children or others from increasing the volume too much by mistake. (👉 p. 105)



## Troubleshooting

---

If a problem should arise, first check the following:

1. Are the connections correct?
2. Is the set being operated as described in the owner's manual?
3. Are the other devices operating properly?



- If steps 1 to 3 above do not improve the problem, restarting the device may improve the problem.  
Continue pressing the  button on the unit until "Restart" appears in the display, or remove and re-insert the power cord of the unit.



If this unit does not operate properly, check the corresponding symptoms in this section.

If the symptoms do not match any of those described here, consult your dealer as it could be due to a fault in this unit. In this case, disconnect the power immediately and contact the store where you purchased this unit.



## Power does not turn on / Power is turned off

### Power is not turned on.

- Check whether the power plug is correctly inserted into the power outlet. (👉 p. 40)
- This unit is in standby mode. Press the  button on the main unit or the CD  button on the remote control. (👉 p. 42)

### Power automatically turns off.

- The sleep timer is set. Turn on the power again. (👉 p. 94)
- “Auto-Standby” is set. “Auto-Standby” is triggered when there is no operation for a set amount of time. To disable “Auto-Standby”, set “Auto-Standby” on the menu to “Off”. (👉 p. 109)
- “HDMI Power Off Control” is set. The power of this unit turns off (standby) by linking to the power off operation of an HDMI connected TV. To disable “HDMI Power Off Control”, set “HDMI Power Off Control” on the setup menu to “Off”. (👉 p. 108)

### When the power is turned on, the protection circuit indicator flashes in orange.

- The protection circuit has been activated due to an error in the internal power supply. Unplug the power cord and contact our customer service center.



## Operations cannot be performed through the remote control unit

### Operations cannot be performed through the remote control unit.

- Batteries are worn out. Replace with new batteries. (🔍 p. 8)
- Operate the remote control unit within a distance of about 23 ft/7 m from this unit and at an angle of within 30°. (🔍 p. 8)
- Remove any obstacle between this unit and the remote control unit.
- Insert the batteries in the proper direction, checking the ⊕ and ⊖ marks. (🔍 p. 8)
- The unit's remote control sensor is exposed to strong light (direct sunlight, inverter type fluorescent bulb light, etc.). Move the set to a place in which the remote control sensor will not be exposed to strong light.
- When using a 3D video device, the remote control unit of this unit may not function due to effects of infrared communications between units (such as TV and glasses for 3D viewing). In this case, adjust the direction of units with the 3D communications function and their distance to ensure they do not affect operations from the remote control unit of this unit.
- When using this unit independently, set the switch to INTERNAL. (🔍 p. 38)
- In the "Line Out Level" setting, select "Custom" and if the target input source (HDMI/HEOS/Bluetooth) is "Fixed", change it to "Variable". (🔍 p. 102)
- To adjust the volume of the audio signal that is output from the analog audio output terminal (VARIABLE) of the unit, set the remote control to network CD player operation mode. (🔍 p. 115)

## Display on this unit shows nothing

### Display is off.

- Press the DIMMER button, and change the setting to anything other than off. (🔍 p. 93)



## No sound comes out

### No sound is produced. Or sound is distorted.

- Check the connections for all devices. (👉 p. 20)
- Insert connection cables all the way in.
- Check that input connectors and output connectors are not reversely connected.
- Check cables for damage.
- Check the amplifier's functions and controls and adjust as necessary.
- When connecting to a device with digital audio input connectors, set "Digital Out" to "On". (👉 p. 105)
- Digital audio output stops when playing a file with a DSD signal or a linear PCM signal with a sampling frequency of 352.8 kHz or higher.
- Set "Variable Out" to "On" in the menu when connecting a power amplifier to the analog audio output connectors (VARIABLE). (👉 p. 104)



## Sound is interrupted or noise occurs

### **During playback from the Internet radio or USB flash drive, sound is occasionally interrupted.**

- When the transfer speed of the USB flash drive is slow, sound may occasionally be interrupted.
- The network communication speed is slow or the radio station is busy.

### **Sound is interrupted during playback of tracks saved on a computer.**

- Do not start applications other than the player software while playing music on your computer.
- The sound may be interrupted depending on the hardware or software configuration of the computer being used.

### **When making a call on mobile phone, noise occurs in audio output on this unit.**

- When making a call, keep a distance of 0.7 ft/20 cm or longer between mobile phone and this unit.

### **During playback from the CD-R/CD-RW, sound is occasionally interrupted.**

- The sound may skip during playback of a CD-R/CD-RW containing a high-resolution audio source.
- This may be caused by poor recording conditions, or the disc itself may be of poor quality. Use a correctly recorded disc.



**Sound cuts out when using Wi-Fi connection.**

- The frequency band used by the wireless LAN is also used by microwave ovens, cordless telephones, wireless game controllers and other wireless LAN devices. Using such devices at the same time as this unit may cause sound to cut out due to electronic interference. Sound cut out can be improved using the following methods. (👉 p. 35)
  - Install devices that cause interference away from this unit.
  - Turn off the power supply to devices that cause interference.
  - Change the settings of the router channel to which this unit is connected to. (See the instruction manual of the wireless router for details on how to change the channel.)
  - Switch to a wired LAN connection.
- Particularly when you play back large music files, depending on your wireless LAN environment, the playback sound may be interrupted. In this case, make the wired LAN connection. (👉 p. 111)

**Sound is interrupted or noise occurs.**

- The “Lock Range” setting in the menu is too narrow. Broaden the “Lock Range” setting while listening to music until the music sounds normal. (👉 p. 101)

## Desired sound does not come out

**The volume does not increase.**

- The maximum volume of the audio signal output from the analog audio output terminals (VARIABLE) is set too low. Set the maximum volume using “Volume Limit” on the menu. (👉 p. 105)

**Headphone volume is low.**

- Switch “H/P Amplifier Gain” to “High” if using headphones with high impedance or low sensitivity. (👉 p. 106)



## AirPlay cannot be played back

### The AirPlay icon is not displayed on iTunes / iPhone / iPod touch / iPad.

- This unit and PC / iPhone / iPod touch / iPad are not connected to the same network (LAN). Connect it to the same LAN as this unit. (👉 p. 35)
- The firmware on iTunes / iPhone / iPod touch / iPad is not compatible with AirPlay. Update the firmware to the latest version.
- Set “Network & USB-A” in the menu to “On”. The AirPlay function does not work when “Network & USB-A” is “Off”. (👉 p. 111)

### Audio is not output.

- The volume on iTunes / iPhone / iPod touch / iPad is set to the minimum level. The volume of the audio output from the analog audio output connectors (VARIABLE) is linked to the volume of your iTunes / iPhone / iPod touch / iPad. Set a proper volume level.
- The AirPlay playback is not performed, or this unit is not selected. Click the AirPlay icon on the iTunes / iPhone / iPod touch / iPad screen and select this unit. (👉 p. 88)

### Audio is interrupted during the AirPlay playback on iPhone / iPod touch / iPad.

- Quit the application running in the background of the iPhone/iPod touch/iPad, and then play using AirPlay.
- Some external factors may be affecting the wireless connection. Modify the network environment by taking measures such as shortening the distance from the wireless LAN access point.

### iTunes cannot be played back through the remote control unit.

- Enable the “Allow iTunes audio control from remote speakers” setting on iTunes. Then, you can perform playback, pause, and skip operations through the remote control unit.



## USB flash drives cannot be played back

### USB flash drive is not recognized.

- Disconnect and reconnect the USB flash drive. (👉 p. 34)
- Mass storage class compatible USB flash drives are supported.
- This unit does not support a connection through a USB hub. Connect the USB flash drive directly to the USB port.
- The USB flash drive must be formatted to FAT32 or NTFS.
- Not all USB flash drives are guaranteed to work. Some USB flash drives are not recognized. When using a type of portable hard disc drive compatible with the USB connection that requires power from an AC adapter, use the AC adapter that came with the drive.
- Set “Network & USB-A” in the menu to “On”. The USB flash drive playback function does not work when “Network & USB-A” is “Off”. (👉 p. 111)

### Files on the USB flash drive are not displayed.

- Files of a type not supported by this unit are not displayed. (👉 p. 49)
- This unit is able to display files in a maximum of eight folder layers. A maximum of 5000 files (folders) can also be displayed for each layer. Modify the folder structure of the USB flash drive.
- When multiple partitions exist on the USB flash drive, only files on the first partition are displayed.

### iOS and Android devices are not recognized.

- The USB port of this unit does not support playback from iOS and Android devices.

### Files on a USB flash drive cannot be played.

- Files are created in a format that is not supported by this unit. Check the formats supported by this unit. (👉 p. 141)
- You are attempting to play a file that is copyright protected. Files that are copyright protected cannot be played on this unit.
- Playback may not be possible if the album art file size exceeds 2 MB.



## Bluetooth cannot be played back

### Bluetooth devices cannot be connected to this unit.

- The Bluetooth function in the Bluetooth device has not been enabled. See the Owner's Manual of the Bluetooth device to enable the Bluetooth function.
- Bring the Bluetooth device near to this unit.
- The Bluetooth device cannot connect with this unit if it is not compatible with the A2DP profile.
- Turn the power of the Bluetooth device off and on again, and then try again.
- Set "Bluetooth" in the setup menu to "On". The Bluetooth function does not work when "Bluetooth" is "Off". (🔧 p. 112)
- Set "Network & USB-A" in the setup menu to "On". The Bluetooth function does not work when "Network & USB-A" is "Off". (🔧 p. 111)

### Smartphones and other Bluetooth devices cannot be connected.

- Smartphones and other Bluetooth devices cannot be connected when "Headphone" is set to "On". Press Bluetooth on the remote control to switch the input source to Bluetooth, then connect the device. (🔧 p. 112)

### Cannot connect Bluetooth headphones.

- Bring the Bluetooth headphones near to this unit.
- Turn the power of the Bluetooth headphones off and on again, and then try again.
- Go to "Network" - "Bluetooth", and set "Headphone" to "On" within the setup menu. (🔧 p. 112)
- Make sure this unit is not already connected to another pair of Bluetooth headphones. Check the currently connected Bluetooth headphones in the "Devices" menu. (🔧 p. 112)  
Disconnect the connected Bluetooth headphones before connecting the ones you want to use.
- Bluetooth headphones cannot be connected if Bluetooth is being used as an input source.
- Bluetooth headphones cannot be connected if this unit is grouped in the HEOS app. Remove this unit from the group to enable Bluetooth headphones connection.
- Bluetooth headphones cannot be connected if a HEOS Built-in device is playing an input source from this unit.
- The Bluetooth headphones cannot connect with this unit if it is not compatible with the A2DP profile.
- Connection and operation are not guaranteed for all Bluetooth-enabled devices.
- This unit can only connect to one Bluetooth headphone at a time. However, up to 8 Bluetooth headphones can be registered. You can switch between registered devices from "Devices" in the "Bluetooth" menu. (🔧 p. 112)



**The sound is cut off.**

- Bring the Bluetooth device near to this unit.
- Remove obstructions between the Bluetooth device and this unit.
- To prevent electromagnetic interference, locate this unit away from microwave ovens, wireless LAN devices and other Bluetooth devices.
- Reconnect the Bluetooth device.

**The sound is cut off or noise occurs when using Bluetooth headphones.**

- Move the Bluetooth headphones closer to this unit.
- Remove obstructions between the Bluetooth headphones and this unit.
- Reconnect the Bluetooth headphones.
- To prevent electromagnetic interference, locate this unit away from microwave ovens, wireless LAN devices and other Bluetooth devices.
- We recommend using wired LAN to connect this unit and other devices.
- Bluetooth transmits on the 2.4 GHz band which may interfere with Wi-Fi transmitted on this band. Connect this unit and other devices to Wi-Fi network on a 5 GHz band if available on your Wi-Fi router.

**Audio is delayed on my Bluetooth headphones.**

- This unit cannot adjust audio delay on Bluetooth headphones.



## The Internet radio cannot be played back

### A list of broadcasting stations is not displayed.

- The LAN cable is not properly connected, or the network is disconnected. Check the connection status. (👉 p. 35)

### Internet Radio cannot be played.

- The selected radio station is broadcasting in a format that is not supported by this unit. Formats that can be played back in this unit are WMA, MP3 and MPEG-4 AAC. (👉 p. 147)
- The firewall function is enabled on the router. Check the firewall setting.
- Check the power of the router is on.
- Some radio stations broadcast silently during some time period. In this case, no audio is output. Wait for a while and select the same radio station, or select another radio station. (👉 p. 45)
- The selected radio station is not in service. Select a radio station in service.

### Cannot connect to favorite radio stations.

- Radio station is not currently in service. Register radio stations in service.



## Music files on PC or NAS cannot be played back (Music server)

### Files stored on a computer cannot be played.

- Files are stored in a non-compatible format. Record in a compatible format. (👉 p. 146)
- Files that are copyright protected cannot be played on this unit.
- Even if PC is connected to the USB port on this unit, music files on it cannot be played back. Connect PC to this unit through the network. (👉 p. 35)
- Media sharing settings on the server or NAS do not allow this unit. Change the settings to allow this unit. For details, see the owner's manual of the server or NAS.

### Server is not found, or it is not possible to connect to the server.

- The computer's or router's firewall is activated. Check the computer's or router's firewall settings.
- Computer's power is not turned on. Turn on the power.
- Server is not running. Launch the server.

### Files on PC or NAS are not displayed.

- Files of a type not supported by this unit are not displayed. (👉 p. 146)

### Music stored on a NAS cannot be played.

- If you use a NAS in conformity with the DLNA standard, enable the DLNA server function in the NAS setting.
- If you use a NAS that does not conform with the DLNA standard, play the music via a PC. Set Windows Media Player's media sharing function and add NAS to the selected play folder.
- If connection is restricted, set audio equipment as the connection target.



## Various online services cannot be played

### Various online services cannot be played.

- The online service may have been discontinued.

## Cannot connect to a wireless LAN network

### Cannot connect to the network.

- Make sure your mobile device is connected to your wireless network before setting up this unit. (🔍 p. 60)
- You can connect this unit to your network router using an Ethernet cable sold separately. Once connected via Ethernet, the HEOS app should recognize this unit and you can manually move it to your wireless network using “Settings” - “My Devices” - (“Device Name”) - “Network”.
- Shorten the distance from the wireless LAN access point and remove any obstructions to improve access first before re-connecting again. Place the unit away from microwave ovens and other network access points.
- Configure the access point channel settings away from channels that are being used by other networks.
- This unit is not compatible with WEP (TSN).

### Cannot connect to a WPS Router.

- Check that the WPS mode of the router is operating.
- After you press the WPS button on the router, within two minutes, press and hold the CONNECT button on the rear panel for 5 seconds. (🔍 p. 114)
- A router/settings that are compatible with WPS 2.0 standards are required. Set the encryption time to “None”, WPA-PSK (AES) or WPA2-PSK (AES).
- If the router encryption method is WEP/WPA-TKIP/WPA2-TKIP, you cannot connect by using the WPS button on the router. In this case, connect using the HEOS app or connect by sharing the Wi-Fi setting of your iOS device. (🔍 p. 114)

### Cannot connect to the network using iPhone/iPod touch/iPad.

- Update the iPhone/iPod touch/iPad firmware to the latest version.
- When configuring the settings via a wireless connection, iOS 10.0.2 or later needs to be supported.

### Cannot connect to the network during standby.

- Set “Network Control” of the settings menu to “On”. If “Network Control” is set to “Off”, the network function is suspended during standby. (🔍 p. 113)



## Cannot playback Discs

### **Cannot playback when the play button is pressed, or cannot correctly play back a specific part of the disc.**

- The disc is dirty or scratched. Either clean the disc, or insert a different disc. (👉 p. 144)

### **Cannot playback CD-R/CD-RW.**

- Discs cannot be played back unless they have been finalized. Use a finalized disc. (👉 p. 139)
- This may be caused by poor recording conditions, or the disc itself may be of poor quality. Use a correctly recorded disc.
- Files are created in a format that is not supported by this unit. Check the formats supported by this unit. (👉 p. 139)

### **“No Disc” is displayed.**

- “No Disc” is displayed if the disc is loaded upside-down or if no disc is loaded.

### **“System Error” is displayed.**

- “System Error” is displayed when an error not caused by disc, format, etc., occurs. Contact our customer service center.

### **“Can’t Read Disc” is displayed.**

- “Can’t Read Disc” is displayed when the inserted disc cannot be read because it is not compatible with this unit or is dirty or scratched. Check the disc.

### **“Wrong Format” is displayed.**

- “Wrong Format” is displayed for files created in a format that is not supported by this unit. Check the formats supported by this unit. (👉 p. 139)



## Music files on PC or Mac cannot be played back (USB-DAC)

### **This unit is not recognized on the computer.**

- Reconnect the USB cable to the USB port on your computer. When this unit is still not recognized after reconnection, connect to a different USB port. (👉 p. 33)
- Restart your computer.
- Check the OS of your computer. (👉 p. 78)
- When your computer is running on Windows, a dedicated driver software should be installed. (👉 p. 79)

### **This unit is not selected as the playback device.**

- Select this unit as the playback device in the sound settings on the computer. (👉 p. 78)

### **“Signal Unlock” is displayed.**

- When digital audio signals cannot be detected properly, “Signal Unlock” is displayed. (👉 p. 86)

### **“Unsupported” is displayed.**

- “Unsupported” is displayed when audio signals that are not supported by this unit are input. Check the settings on your computer or player software. (👉 p. 86)
- If the computer you use is macOS, please check if the CD 50n format is set below 384.0 kHz using the Audio MIDI Setup. (👉 p. 85)



## Audio from digital devices cannot be played back (HDMI ARC/Coaxial/Optical)

### “Signal Unlock” is displayed.

- When digital audio signals cannot be detected properly, “Signal Unlock” is displayed. (🔍 p. 76)

### “Unsupported” is displayed.

- “Unsupported” is displayed when audio signals that are not supported by this unit are input. Check the audio output signal format from your digital device. (🔍 p. 76)
- Only the PCM 2-channel setting can be used to play sound from a TV via the HDMI ARC function. Set “PCM 2ch” as the audio format in the TV settings.

## The input source switches to “HDMI”, “Optical” or “Coaxial”

### The input source automatically switches to “HDMI”, “Optical” or “Coaxial” when the TV connected to this unit is turned on.

- Set “Off” to “Auto-Play”. (🔍 p. 107)

## The HDMI control function does not work

### The HDMI control function does not work.

- You cannot operate devices that are not compatible with the HDMI control function. In addition, depending on the connected device or the settings, the HDMI control function may not work. In this case, operate the external device directly.
- Check that the HDMI control function setting is enabled on TV connected to this unit.



## Update/upgrade error messages

If an update/upgrade is interrupted or fails, an error message appears.

Display	Description
<b>Connection failed. Please check your network, then try again.</b>	The network connection is unstable. Connection to the server failed. Check your network environment and try the update again.
<b>Update failed. Please check your network, then try again.</b>	The download of the firmware failed. Check your network environment and try the update again.
<b>Upgrade failed. Please check your network, then try again.</b>	The download of the firmware failed. Check your network environment and try the upgrade again.
<b>Please check your network, unplug and reconnect the power cord, and try again.</b>	The update failed. Press and hold the  on the main unit for more than 5 seconds, or remove and re-insert the power cord. The update restarts automatically.
<b>Please contact customer service in your area.</b>	This unit may be broken. Contact our Customer Service Center in your area.



## Resetting network settings

If network contents cannot be played or the unit cannot connect to the network, restarting the unit may improve the problem. We recommend restarting the unit before returning the settings to the default settings. (☞ p. 120)

If the operations are not improved by restarting the unit, follow the steps below.

Network settings are reset to the factory default values. Make settings again.

However, the menu “Audio” settings are not reset.

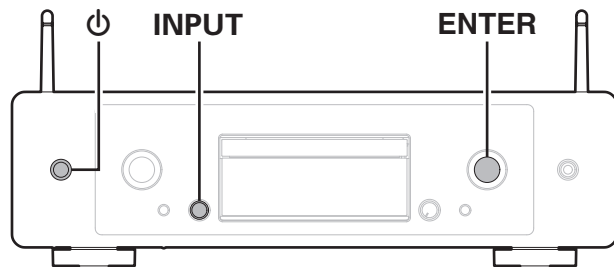

- 1** Press **POWER** on the main unit to turn on power to the unit.
- 2** Turn the **INPUT** selector to select “HEOS”, then press **ENTER**.
- 3** Turn the **INPUT** selector to select “Internet Radio”, “Music Servers” or “USB Music”.
- 4** When the power to this unit is on, press and hold **POWER** for 3 seconds or more while pressing **ENTER** on the main unit.
- 5** Remove your fingers from the two buttons when “Please wait” appears on the display.
- 6** “Completed” is shown in the display when reset is complete.

### NOTE

- Do not turn the power off until reset is complete.



# Factory Restore

When the unit or the network functions do not work properly, operation may be improved by restoring the firmware to the factory defaults.

Perform this operation if it does not work after attempting “General” - “Reset” of the settings menu. (☞ p. 110)

After performing the Factory Restore, various settings are reset to the default settings. Configure the network settings and update the firmware again.

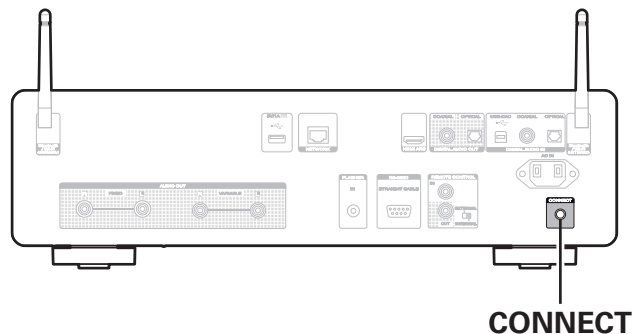

- 1 Unplug the power cord from the power outlet.**
- 2 Plug in the power cord while holding down CONNECT.**
- 3 When “Factory Restore” appears on the display, release the buttons.**

When the Factory Restore is complete, “Factory Restore Completed” appears on the display for about 5 seconds, and the unit automatically restarts.



- This operation takes time because it requires reconnecting to the network, restoring and updating the firmware.
- If this operation does not improve the problem, contact our customer service center.

#### NOTE



- Do not turn off the power until the Factory Restore is complete.

#### WARNING

By initiating Factory Restore mode, you will be installing limited recovery firmware on this unit. Functionality will remain limited until a firmware update is performed over the Internet. Do not perform a Factory Restore if you do not have this unit connected to your home network.



## Playing back Discs

Playable media	
CD	
CD-R	
CD-RW	

### NOTE

- Some discs and some recording formats cannot be played.
- Non-finalized discs cannot be played.

## Files

### ■ Specifications of supported files

	Sampling frequency	Bit rate	Extension
<b>MP3</b>	32/44.1/48 kHz	48 – 320 kbps	.mp3
<b>WMA</b>	32/44.1/48 kHz	48 – 320 kbps	.wma

### ■ Maximum number of playable files and folders

Maximum number of folders : 256

Total number of folders and files : 512

### NOTE

- Be sure to give files the extension. Files with any other extensions or files with no extensions cannot be played.
- Recordings you have made should only be used for your personal enjoyment, and as per copyright laws may not be used in other ways without permission of the copyright holder.



- Only music files that are not copyright-protected can be played on this unit.
  - Content downloaded from pay sites on the Internet are copyright protected. Also, files encoded in WMA format when ripped from a CD, etc. on a computer may be copyright protected, depending on the computer's settings.
- The maximum number of files and folders that can be played differs depending on conditions such as the length of the file name or folder name or the number of levels in the folder hierarchy.



## Playback order of music files

When there are multiple folders containing music files, the playback order of folders is automatically set when this unit reads the media. Files in each folder are played in alphabetical order of file name.

### CD-R/CD-RW

For playback of files on CD-R or CD-RW, files in all folders on the first layer are played first, next on the second layer, then next on the third layer, and so on in this order.



- The playback order displayed on a PC may differ from the actual playback order.
- The playback order with a CD-R/CD-RW may differ, depending on the writing software.

## About discs and files

Music files recorded on CD-R/CD-RW are divided into large segments (folders) and small segments (files). Files are stored in folders, and folders can be placed for storage in a hierarchy. The unit can recognize up to 16 levels of folders.

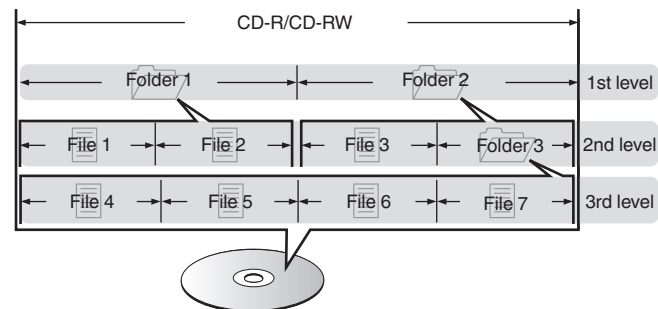

- When writing music files on a CD-R/CD-RW disc, set the writing software's format to "ISO9660". The files may not play properly if they are recorded in other formats. For details, refer to the instructions of your writing software.



## Playing back a USB flash drives

- This unit is compatible with MP3 ID3-Tag (Ver. 2) standard.
- This unit is compatible with WMA META tags.
- If the image size (pixels) of an album artwork exceeds 500 × 500 (WMA/MP3/Apple Lossless/DSD) or 349 × 349 (MPEG-4 AAC), then music may not be played back properly.

### ■ Specifications of supported files

	Sampling frequency	Bit rate	Extension
WMA*1	32/44.1/48 kHz	48 – 192 kbps	.wma
MP3	32/44.1/48 kHz	32 – 320 kbps	.mp3
WAV	32/44.1/48/88.2/96/ 176.4/192/352.8/384 kHz	–	.wav
MPEG-4 AAC*1	32/44.1/48 kHz	48 – 320 kbps	.aac/.m4a
FLAC	44.1/48/88.2/96/ 176.4/192/352.8/384 kHz	–	.flac
Apple Lossless*2	44.1/48/88.2/96/ 176.4/192/352.8/384 kHz	–	.m4a
DSD	2.8/5.6/11.2 MHz	–	.dsf/.dff

\*1 Only files that are not protected by copyright can be played on this unit.  
Content downloaded from pay sites on the Internet are copyright protected. Also, files encoded in WMA format when ripped from a CD, etc. on a computer may be copyright protected, depending on the computer's settings.

\*2 The Apple Lossless Audio Codec (ALAC) decoder is distributed under the Apache License, Version 2.0 (<http://www.apache.org/licenses/LICENSE-2.0>).



## ■ Maximum number of playable files and folder

The limits on the number of folders and files that can be displayed by this unit are as follows.

Item	Media	USB flash drive
Number of folder directory levels *1		8 levels
Number of folders		500
Number of files*2		5000
Maximum file size of one audio file		2 GB

\*1 The limited number includes the root folder.

\*2 The allowable number of files may differ according to the USB flash drive capacity and the file size.

### NOTE

- Digital audio output stops during playback of the DSD files.



## Cautions on using media

### Inserting a disc

- Set the disc in the tray label side up.
- Make sure the disc tray is fully open when inserting the disc.
- Place the discs flatly, 5 inch/12 cm discs in the outer tray guide (Figure 1), 3 inch/8 cm discs in the inner tray guide (Figure 2).

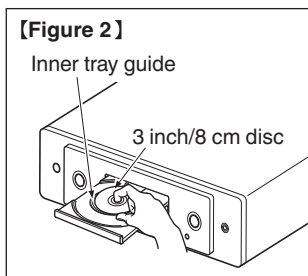
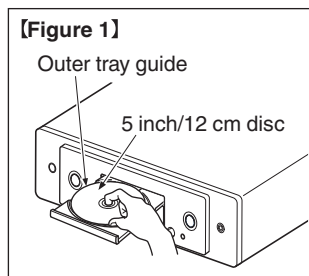

- Place 3 inch/8 cm discs in the inner tray guide without using an adapter.

#### NOTE

- Only load one disc at a time. Loading two or more discs can damage the unit or scratch the discs.
- Do not use cracked or warped discs or discs that have been repaired with adhesive, etc.
- Do not use discs on which the sticky part of cellophane tape or labels is exposed or on which there are traces of where labels have been removed. Such discs can get caught inside the player and damage it.
- Do not use discs in special shapes, as they may damage the unit.



- Do not push the disc tray in by hand when the power is off. Doing so could damage the unit.
- Do not place any foreign objects in the disc tray. Doing so could result in damage.
- If the unit is left in a room full of smoke from cigarettes, etc., for long periods of time, the surface of the optical pickup may get dirty, preventing it from receiving signals properly.



## How to handle media

- Do not get fingerprints, oil or dirt on discs.
- Take special care not to scratch discs when removing them from their cases.
- Do not bend or heat discs.
- Do not enlarge the hole in the center.
- Do not write on the labeled (printed) surface with ball-point pens, pencils, etc., or stick new labels on discs.
- Condensation may form on discs if they are moved suddenly from a cold place (outdoors for example) to a warm place, but do not try to dry discs with a hairdryer, etc.
- Do not eject a USB flash drive or turn off the unit while a USB flash drive is being played. This may result in malfunction or loss of the USB flash drive's data.
- Do not attempt to open or modify a USB flash drive.
- USB flash drive and files can be damaged by static electricity. Do not touch the metal contacts of a USB flash drive with your fingers.
- Do not use warped USB flash drive.
- After use, be sure to remove any disc or USB flash drive, and store it in its proper case, to avoid dust, scratches and deformation.
- Do not store discs in the following places:
  1. Places exposed to direct sunlight for long periods of time
  2. Dusty or humid places
  3. Places exposed to heat from heaters, etc.

## Cleaning discs

- If there are fingerprints or dirt on a disc, wipe them off before using the disc.
- Use a commercially available disc cleaning set or a soft cloth to clean discs.



Gently wipe the disc from the inside towards the outside.

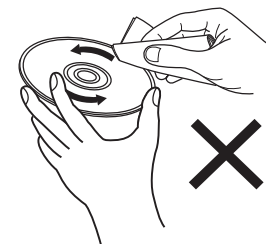

Do not wipe with a circular motion.

### NOTE

- Do not use record spray, antistatic agents, benzene, thinner or other solvents.



## Digital input

### ■ Specifications of supported audio formats

#### □ USB-DAC

	Sampling frequency	Bit length
DSD (2-channel)	2.8/5.6/ 11.2 MHz	1 bit
Linear PCM (2-channel)	44.1/48/88.2/96/ 176.4/192/352.8/ 384 kHz	16/24/32 bits



- Digital audio output stops during playback of the DSD files and linear PCM signals with a sampling frequency of 352.8/384 kHz.

#### □ HDMI ARC/Coaxial/Optical

	Sampling frequency	Bit length
Linear PCM (2-channel)	32/44.1/48/88.2/96/ 176.4/192 kHz	16/24 bits

## Playing back a Bluetooth device

This unit supports the following Bluetooth profile.

- A2DP (Advanced Audio Distribution Profile):  
When a Bluetooth device that supports this standard is connected, monaural and stereo sound data can be streamed at a high quality.
- AVRCP (Audio/Video Remote Control Profile):  
When a Bluetooth device that supports this standard is connected, the Bluetooth device can be operated from this unit.

### ■ About Bluetooth communications

Radio waves broadcast from this unit may interfere with the operation of medical devices. Make sure you turn off the power of this unit and Bluetooth device in the following locations as radio wave interference may cause malfunctions.

- Hospitals, trains, aircraft, petrol kiosks and places where flammable gases are generated
- Near automatic doors and fire alarms



## Playing back files stored on a PC and NAS

- This unit is compatible with MP3 ID3-Tag (Ver. 2) standard.
- This unit is compatible with WMA META tags.
- If the image size (pixels) of an album artwork exceeds 500 × 500 (WMA/MP3/WAV/FLAC) or 349 × 349 (MPEG-4 AAC), then music may not be played back properly.
- A server or server software compatible with distribution in the corresponding formats is required to play music files via a network.
- The maximum size of audio file that can be played on this unit is 2 GB per file.

For playing mentioned audio formats via a network a server software, for example Twonky Media Server or jRiver Media Server, needs to be installed on your computer or NAS for full support. There are other server software available too. Please check supported formats.

### ■ Specifications of supported files

	Sampling frequency	Bit rate	Extension
WMA*1	32/44.1/48 kHz	48 – 192 kbps	.wma
MP3	32/44.1/48 kHz	32 – 320 kbps	.mp3
WAV	32/44.1/48/88.2/96/ 176.4/192/352.8/384 kHz	–	.wav
MPEG-4 AAC*1	32/44.1/48 kHz	48 – 320 kbps	.aac/.m4a
FLAC	44.1/48/88.2/96/ 176.4/192/352.8/384 kHz	–	.flac
Apple Lossless*2	44.1/48/88.2/96/ 176.4/192/352.8/384 kHz	–	.m4a
DSD	2.8/5.6/11.2 MHz	–	.dsf/.dff

\*1 Only files that are not protected by copyright can be played on this unit.

Content downloaded from pay sites on the Internet are copyright protected. Also, files encoded in WMA format when ripped from a CD, etc., on a computer may be copyright protected, depending on the computer's settings.

\*2 The Apple Lossless Audio Codec (ALAC) decoder is distributed under the Apache License, Version 2.0 (<http://www.apache.org/licenses/LICENSE-2.0>).

#### NOTE

- Digital audio output stops during playback of the DSD files.



## Playing back Internet Radio

---

### ■ Playable broadcast station specifications

	Sampling frequency	Bit rate	Extension
WMA	32/44.1/48 kHz	48 – 192 kbps	.wma
MP3	32/44.1/48 kHz	32 – 320 kbps	.mp3
MPEG-4 AAC	32/44.1/48 kHz	48 – 320 kbps	.aac/ .m4a

## Last function memory

---

This function stores the settings which were made before going into the standby mode.



## About HDMI

---

This unit supports the following HDMI functions.

- **ARC (Audio Return Channel) function**

Enjoy movies, music, etc., on your TV simply by connecting an ARC function-compatible TV to this unit via HDMI.

- **HDMI control function**

Connect an HDMI control-compatible TV and this unit via HDMI and enable the HDMI control to enable linked control from either device.

- Input source switching

If the TV is turned on, this unit automatically powers on and switches the input source.

- Power off link

The TV power off operation is linked so this unit also turns off.

- Volume adjustment

Use the remote control unit to adjust the volume for the audio signal output from the analog audio output terminals (VARIABLE) of this unit.

- Audio output destination switching

If this unit is turned on, TV audio is output from this unit. If this unit is turned off, TV audio is output from the speakers of the TV.



- Some functions may not operate depending on the connected TV.



## Explanation of terms

---

### ■ Audio

#### **AIFF (Audio Interchange File Format)**

This is an uncompressed and lossless format for digital audio. Use AIFF files to burn high-quality audio CDs from imported songs. AIFF files use approximately 10 MB of disk space per minute.

#### **Apple Lossless Audio Codec**

This is a codec for lossless audio compression method developed by Apple Inc. This codec can be played back on iTunes, iPod or iPhone. Data compressed to approximately 60 – 70 % can be decompressed to exactly the same original data.

#### **DSD (Direct-Stream Digital)**

One of the audio data recording methods, it is the signal aspect used to store audio signals on a super audio CD, and is  $\Delta$ - $\Sigma$  modulated digital audio.

#### **FLAC (Free Lossless Audio Codec)**

FLAC stands for Free lossless Audio Codec, and is a lossless free audio file format. Lossless means that the audio is compressed without any loss in quality.

The FLAC license is as shown below.

Copyright (C) 2000,2001,2002,2003,2004,2005,2006,2007,2008,2009  
Josh Coalson

Redistribution and use in source and binary forms, with or without modification, are permitted provided that the following conditions are met:

- Redistributions of source code must retain the above copyright notice, this list of conditions and the following disclaimer.
- Redistributions in binary form must reproduce the above copyright notice, this list of conditions and the following disclaimer in the documentation and/or other materials provided with the distribution.
- Neither the name of the Xiph.org Foundation nor the names of its contributors may be used to endorse or promote products derived from this software without specific prior written permission.



THIS SOFTWARE IS PROVIDED BY THE COPYRIGHT HOLDERS AND CONTRIBUTORS "AS IS" AND ANY EXPRESS OR IMPLIED WARRANTIES, INCLUDING, BUT NOT LIMITED TO, THE IMPLIED WARRANTIES OF MERCHANTABILITY AND FITNESS FOR A PARTICULAR PURPOSE ARE DISCLAIMED. IN NO EVENT SHALL THE FOUNDATION OR CONTRIBUTORS BE LIABLE FOR ANY DIRECT, INDIRECT, INCIDENTAL, SPECIAL, EXEMPLARY, OR CONSEQUENTIAL DAMAGES (INCLUDING, BUT NOT LIMITED TO, PROCUREMENT OF SUBSTITUTE GOODS OR SERVICES; LOSS OF USE, DATA, OR PROFITS; OR BUSINESS INTERRUPTION) HOWEVER CAUSED AND ON ANY THEORY OF LIABILITY, WHETHER IN CONTRACT, STRICT LIABILITY, OR TORT (INCLUDING NEGLIGENCE OR OTHERWISE) ARISING IN ANY WAY OUT OF THE USE OF THIS SOFTWARE, EVEN IF ADVISED OF THE POSSIBILITY OF SUCH DAMAGE.

#### **Linear PCM**

This is an uncompressed PCM (Pulse Code Modulation) signal. Unlike lossy compression audio sources such as MP3, no audio quality or dynamic range deteriorates.

#### **MP3 (MPEG Audio Layer-3)**

This is an internationally standardized audio data compression scheme, using the "MPEG-1" video compression standard. It compresses the data volume to about one eleventh its original size while maintaining sound quality equivalent to a music CD.

#### **MPEG (Moving Picture Experts Group), MPEG-2, MPEG-4**

These are the names for digital compression format standards used for the encoding of video and audio. Video standards include "MPEG-1 Video", "MPEG-2 Video", "MPEG-4 Visual", "MPEG-4 AVC". Audio standards include "MPEG-1 Audio", "MPEG-2 Audio", "MPEG-4 AAC".

#### **WMA (Windows Media Audio)**

This is the audio compression technology developed by Microsoft Corporation.

WMA data can be encoded using Windows Media® Player.

To encode WMA files, only use applications authorized by Microsoft Corporation. If you use an unauthorized application, the file may not work properly.



### Sampling frequency

Sampling involves taking a reading of a sound wave (analog signal) at regular intervals and expressing the height of the wave at each reading in digitized format (producing a digital signal).

The number of readings taken in one second is called the “sampling frequency”. The larger the value, the closer the reproduced sound is to the original.

### Dynamic range

The difference between the maximum undistorted sound level and the minimum discernible level above the noise emitted by the device.

### Bit rate

This expresses the read amount per 1 second of video/audio data recorded in a disc. A larger number means higher sound quality, but also means a larger file size.

## ■ Network

### AirPlay

AirPlay sends (plays) contents recorded in iTunes or on an iPhone/iPod touch to a compatible device via the network.

### WEP Key (network key)

This is key information used for encrypting data when conducting data transfer. On this unit, the same WEP key is used for data encryption and decryption, so the same WEP key must be set on both devices in order for communications to be established between them.

### Wi-Fi®

Wi-Fi Certification assures tested and proven interoperability by the Wi-Fi Alliance, a group certifying interoperability among wireless LAN devices.

### WPA (Wi-Fi Protected Access)

This is a security standard established by the Wi-Fi Alliance. In addition to the conventional SSID (network name) and WEP key (network key), it also uses a user identification function and encrypting protocol for stronger security.

### WPA2 (Wi-Fi Protected Access 2)

This is a new version of the WPA established by the Wi-Fi Alliance, compatible with more secure AES encryption.



### WPA/WPA2-Personal

This is a simple authentication system for mutual authentication when a preset character string matches on the wireless LAN access point and client.

### WPA2/WPA3-Personal

WPA2/WPA3-Personal Mode was defined by Wi-Fi Alliance® to minimize user disruption and provide a gradual migration path to WPA3-Personal while maintaining interoperability with WPA2-Personal only devices.

### WPA3-Personal

WPA3-Personal replaces the WPA2-Personal Pre-Shared Key (PSK) authentication with Simultaneous authentication of equals (SAE). Unlike PSK, SAE is resistant to offline dictionary attacks.

### Network Names (SSID: Service Set Identifier)

When forming wireless LAN networks, groups are formed to prevent interference, data theft, etc. These groups are based on “SSID (network names)”. For enhanced security, a WEP key is set so that communication is unavailable unless both the “SSID” and the WEP key match. This is suitable for constructing a simplified network.

## ■ Other

### Finalizing

This process enables DVD/CD recorded with a recorder to be played by other players.

### Pairing

Pairing (registration) is an operation that is required in order to connect a Bluetooth device to this unit using Bluetooth. When paired, the devices authenticate each other and can connect without mistaken connections occurring.

When using Bluetooth connection for the first time, you need to pair this unit and the Bluetooth device to be connected.

### Protection circuit

This is a function to prevent damage to devices within the power supply when an abnormality such as an overload, excess voltage occurs or over temperature for any reason.



## Trademark information



Apple, AirPlay, iPad, iPad Air, iPad Pro and iPhone are trademarks of Apple Inc., registered in the U.S. and other countries.

The trademark "iPhone" is used in Japan with a license from Aiphone K.K.

Use of the Works with Apple badge means that an accessory has been designed to work specifically with the technology identified in the badge and has been certified by the developer to meet Apple performance standards.



The Bluetooth® word mark and logos are registered trademarks owned by the Bluetooth SIG, Inc. and any use of such marks by DEI Sales, Inc. is under license. Other trademarks and trade names are those of their respective owners.



The Wi-Fi CERTIFIED logo is a registered trademark of the Wi-Fi Alliance.

Wi-Fi Certification provides assurance that the device has passed the interoperability test conducted by the Wi-Fi Alliance, a group that certifies interoperability among wireless LAN devices.



The terms HDMI, HDMI High-Definition Multimedia Interface, HDMI trade dress and the HDMI Logos are trademarks or registered trademarks of HDMI Licensing Administrator, Inc.



App Store® is registered in the U.S. and other countries.





Google Play and the Google Play logo are trademarks of Google LLC.

## ROON READY

Being Roon Ready means that Marantz uses Roon streaming technology, for an incredible user interface, simple setup, rock-solid daily reliability, and the highest levels of audio performance, without compromise.



# Specifications

## ■ Audio section

### • Analog output

**Channels:**

**Playable frequency range:**

**Playable frequency response:**

**S/N:**

**Dynamic range:**

**Harmonic distortion:**

### • Output level

**Unbalanced (fixed):**

**Unbalanced (variable):**

**Headphone output:**

**[PCM]**

2-channels

2 Hz – 96 kHz  
(sampling frequency: 192 kHz)

2 Hz – 20 kHz  
(sampling frequency: 44.1 kHz)

2 Hz – 50 kHz (-3 dB)  
(sampling frequency: 192 kHz)

2 Hz – 20 kHz ( $\pm 1$ dB)  
(sampling frequency: 44.1 kHz)

112 dB (Audible range)

112 dB (24 bit, Audible range)

100 dB (16 bit, Audible range)

0.0010 % (24 bits)

0.0016 % (16 bits)

**[DSD]**

2-channels

2 Hz – 100 kHz

2 Hz – 50 kHz (-3 dB)

112 dB (Audible range)

106 dB (Audible range)

0.0010 %

2.2 V (10 k $\Omega$ /kohms)

4.4 V (10 k $\Omega$ /kohms, variable maximum)

200 mW

(GAIN: HIGH, 32  $\Omega$ /ohms, THD 0.7 % or below)

120 mW

(GAIN: MID, 32  $\Omega$ /ohms, THD 0.7 % or below)

16 mW

(GAIN: LOW, 32  $\Omega$ /ohms, THD 0.7 % or below)



- **Optical readout system**

<b>Laser:</b>	AlGaAs
<b>Wave length:</b>	780 nm
<b>Signal type:</b>	16-bit linear PCM
<b>Sampling frequency:</b>	44.1 kHz

- **Digital output**

<b>Coaxial:</b>	0.5 Vp-p / 75 Ω/ohms
<b>Optical :</b>	-19 dBm

- **Digital input**

<b>Coaxial:</b>	0.5 Vp-p / 75 Ω/ohms
<b>Optical :</b>	-27 dBm or later
<b>USB:</b>	USB Type A (USB 2.0 High speed) USB Type B (USB 2.0 High speed)



## ■ Wireless LAN section

<b>Network type (wireless LAN standard):</b>	Conforming to IEEE 802.11a/b/g/n/ac (Wi-Fi® compliant) *1
<b>Security:</b>	WEP 64 bit, WEP 128 bit WPA/WPA2-PSK (AES) WPA/WPA2-PSK (TKIP) WPA3-SAE (AES)
<b>Used frequency range:</b>	2.4 GHz, 5 GHz

\*1 The Wi-Fi® CERTIFIED Logo and the Wi-Fi CERTIFIED On-Product Logo are registered trademarks of the Wi-Fi Alliance.

## ■ Bluetooth section

<b>Communications system:</b>	Bluetooth Specification Version 5.4
<b>Transmission power:</b>	Bluetooth Specification Power Class 1
<b>Maximum communication range:</b>	Approx. 98.4 ft/30 m in line of sight *2
<b>Used frequency range:</b>	2.4 GHz
<b>Modulation scheme:</b>	FHSS (Frequency-Hopping Spread Spectrum)
<b>Supported profiles:</b>	Receiver function A2DP (Advanced Audio Distribution Profile) 1.4 AVRCP (Audio Video Remote Control Profile) 1.5 Transmitter function A2DP (Advanced Audio Distribution Profile) 1.4
<b>Corresponding codec:</b>	SBC
<b>Transmission range (A2DP):</b>	20 Hz – 20,000 Hz

\*2 The actual communication range varies depending on the influence of such factors as obstructions between devices, electromagnetic waves from microwave ovens, static electricity, cordless phones, reception sensitivity, antenna performance, operating system, application software etc.



## ■ General

<b>Operating temperature:</b>	41 °F - 95 °F (5 °C - 35 °C)
<b>Power supply:</b>	AC 120 V, 60 Hz
<b>Power consumption:</b>	35 W
<b>Power consumption in standby mode :</b>	0.2 W
<b>Power consumption in “Network Control” – “On” mode:</b>	2 W

For the purpose of improvement, the specifications and design are subject to change without notice.



## ■ Dimensions (Unit : in. (mm))

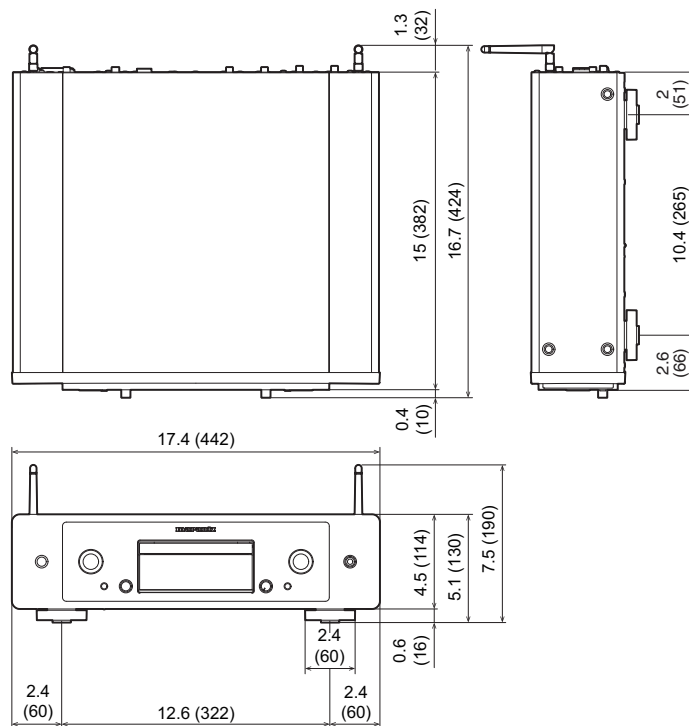

## ■ Weight : 22 lbs 11 oz (10.3 kg)

# Index

<b>A</b>			
AirPlay .....	87		
Amplifier .....	21		
Auto Standby .....	109		
<b>B</b>			
Bluetooth device .....	52		
<b>C</b>			
CD .....	70		
<b>D</b>			
D/A converter function .....	76, 145		
DATA CD .....	73		
Display's brightness .....	93		
<b>E</b>			
External control device .....	37		
<b>F</b>			
Front panel .....	9		
<b>H</b>			
HEOS Account .....	62		
		HEOS Favorites .....	92
<b>I</b>			
Input source .....	43		
Inputting characters .....	98		
Internet Radio .....	44		
<b>M</b>			
Menu map .....	95		
<b>N</b>			
NAS .....	46, 146		
Network settings .....	111		
<b>P</b>			
Pairing .....	52		
PC .....	35, 46, 146		
Program playback .....	72		
<b>Q</b>			
Queue .....	47, 50, 65		
<b>R</b>			
Rear panel .....	12		
Remote control unit .....	15		
Resetting network settings .....	137		
<b>S</b>			
Sleep timer .....	94		
Spotify .....	90		
<b>T</b>			
Tips .....	118		
Troubleshooting .....	120		
<b>U</b>			
USB flash drive .....	34, 49		
USB-DAC .....	33, 78, 145		
<b>W</b>			
Wired LAN .....	35		
Wireless LAN .....	36		



**marantz**

3520 10946 00ASE

© 2023 DEI Sales, Inc. All Rights Reserved.