

# T25

Instructional Audio System



## User Manual





# Table of Contents

## OVERVIEW

- 3** Important Safety Instructions
- 5** System Components and Unpacking
- 6** Optional Components
- 7** Optional Speakers
- 8** T25 Controls and Indicators
- 10** Clearmike Controls and Connections
- 13** Microphone Cradle Charger

## SET-UP & OPERATION

- 14** Connecting the Power Supply
- 15** Charging the Clearmike
- 16** Setting Up the Clearmike
- 18** Pairing your Clearmike
- 19** Output Audio to Assistive Listening Device (ALD)
- 20** Using Your Microphone as a Wireless Audio Link
- 21** Audio Integration
- 22** Analog Control Features

## OPTIONAL ACCESSORIES

- 24** Sharemike Controls and Connections
- 27** Pairing your Sharemike
- 28** Media Connector Controls and Indicators
- 30** Media Connector Set Up and Operation
- 31** Connecting Media Connector to Audio
- 32** Pairing T25 to Media Connector

## MAINTENANCE & TROUBLESHOOTING

- 33** Clearmike Battery Replacement
- 34** Sharemike Battery Replacement
- 35** Troubleshooting
- 36** Tips for Optimum Audio Performance

## WARRANTY, SAFETY & SPECIFICATIONS

- 37** Five-Year Limited Warranty
- 38** Safety Warnings and Certifications
- 45** System Components
- 46** System Specifications



## OVERVIEW

# Important Safety Instructions

1. Do not use the apparatus near water.
2. Clean only with dry cloth.
3. Do not block any ventilation openings.
4. Do not install near any heat sources such as radiators, heat registers, stoves, or other apparatus (including amplifiers) that produce heat.
5. Do not defeat the safety purpose of the polarized or grounding-type plug. A polarized plug has two blades with one wider than the other. A grounding-type plug has two blades and a third grounding prong. The wide blade or the third prong is provided for your safety. If the provided plug does not fit into your outlet, consult an electrician for replacement of the outlet.
6. **WARNING:** Battery pack shall not be exposed to excessive heat such as sunshine, fire or the like. (1) The battery pack is not serviceable. Do not open, disassemble, or service any battery pack. (2) Do not crush or cut or puncture the internal battery cell. (3) Do not short-circuit the battery, or expose it to water or other liquids. (4) Do not touch the internal battery cell for any reason. (5) Keep the battery away from fire or a hot oven. Do not dispose of the battery into fire or a hot oven. (6) Keep the product with battery away from extremely low air pressure or high temperature surrounding environment. Battery subjected to extremely low air pressure may result in an explosion or the leakage of flammable liquid or gas. (7) Stop using the battery pack if it is damaged, or if you notice any discharge or the buildup of foreign materials on the battery contacts. (8) Do not put the battery in trash that is disposed of in landfills. When disposing of the battery pack, comply with local ordinances or regulations.
7. **CAUTION:** Risk of explosion if battery is replaced by any battery other than Lightspeed Part # L3.7V



## OVERVIEW

### Consignes de sécurité importantes

1. N'utilisez pas l'appareil près de l'eau.
2. Nettoyer uniquement avec un chiffon sec.
3. Ne bloquez aucune bouche d'aération.
4. Ne l'installez pas à proximité de sources de chaleur telles que des radiateurs, des registres de chaleur, des cuisinières ou d'autres appareils (y compris des amplificateurs) produisant de la chaleur.
5. N'annulez pas l'objectif de sécurité de la fiche polarisée ou de mise à la terre. Une fiche polarisée a deux lames dont l'une est plus large que l'autre. Une fiche de type mise à la terre a deux lames et une troisième broche de mise à la terre. La lame large ou la troisième dent est prévue pour votre sécurité. Si la fiche fournie ne rentre pas dans votre prise, consultez un électricien pour remplacer la prise.
6. Avertissement: La batterie ne doit pas être exposée à une chaleur excessive telle que le soleil, le feu ou similaire. (1) La batterie n'est pas réparable. N'ouvrez, ne démontez et n'entretenez aucun bloc-piles. (2) Ne pas écraser, couper ou percer la cellule de batterie interne. (3) Ne court-circuitez pas la batterie et ne l'exposez pas à l'eau ou à d'autres liquides. (4) Ne touchez pas la cellule de la batterie interne pour quelque raison que ce soit. (5) Gardez la batterie à l'écart du feu ou d'un four chaud. Ne jetez pas la batterie au feu ou dans un four chaud. (6) Gardez le produit avec la batterie à l'écart d'une pression d'air extrêmement basse ou d'un environnement à haute température. Une batterie soumise à une pression d'air extrêmement faible peut provoquer une explosion ou une fuite de liquide ou de gaz inflammable. (7) Arrêtez d'utiliser la batterie si elle est endommagée ou si vous remarquez une décharge ou l'accumulation de corps étrangers sur les contacts de la batterie. (8) Ne jetez pas la batterie dans des ordures qui sont jetées dans des décharges. Lors de la mise au rebut de la batterie, respectez les ordonnances ou réglementations locales.
7. Mise en garde: Risque d'explosion si la batterie est remplacée par une batterie autre que Lightspeed partie #L3.7V.



# System Components and Unpacking

The standard configuration of the T25 system includes:

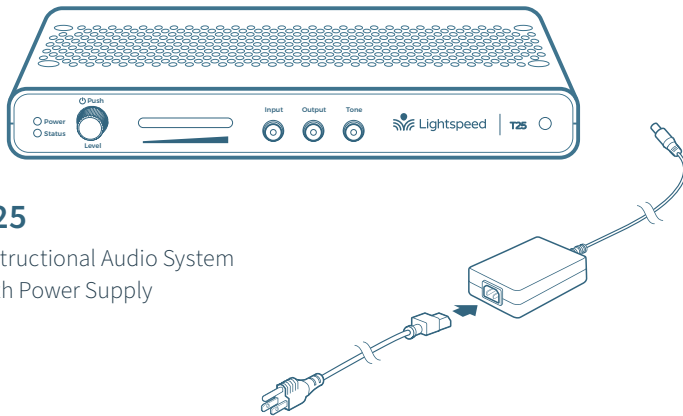

**T25**  
Instructional Audio System  
with Power Supply



**Clearmike**  
Teacher Microphone

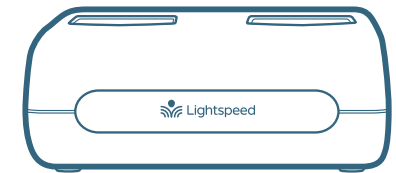

**Microphone Cradle Charger**  
and Power Supply

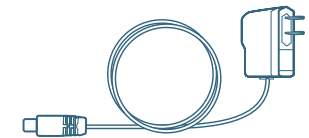

**TIP:** The T25 and wireless microphones are paired together at the factory. Please keep all components together as a system. Moving them from one system or room to another will result in the need to re-pair them to function.



# Optional Components

Optional equipment which may be part of your T25 system.



## SHAREMIKE

Student Microphone *(Optional)*

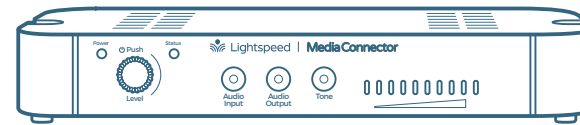

## MEDIA CONNECTOR

and Power Adapter

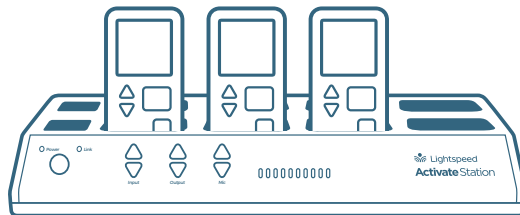
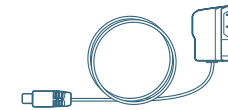

## ACTIVATE SYSTEM

Group Learning Pods

*For further information on Activate,  
please visit [www.lightspeed-tek.com](http://www.lightspeed-tek.com)*



# Optional Speakers

SYSTEMS CAN BE CONFIGURED WITH A VARIETY OF CEILING OR WALL-MOUNTED SPEAKERS, INCLUDING THESE LIGHTSPEED MODELS.

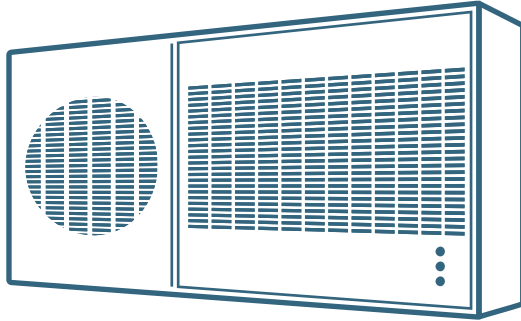

**TCQ** (x 1)  
Hybrid Ceiling Speaker

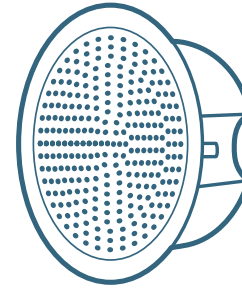

**DRQ** (x 4)  
Ceiling Speaker

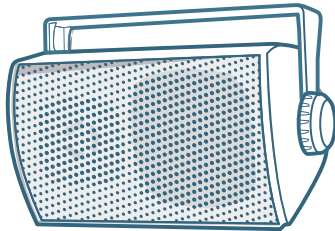

**WMQ** (x 4)  
Wall Speaker  
Available in U.S. and Canada only

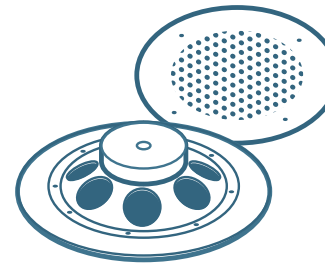

**4JCS** (4 per room)  
Plenum Ceiling Speaker  
Available in U.S. only



# T25 Controls and Indicators

## FRONT PANEL

1. **POWER LIGHT**  
**White light:** Power on
2. **STATUS LIGHT:** Microphone link and pair indicators.  
**Green light:** Microphone(s) is/are connected to the system  
**Off:** Microphone(s) is/are not connected to the system
3. **POWER BUTTON / VOLUME ADJUSTMENT:** Press and hold this button for one second to turn the system power on or off. This also functions as an adjustment knob for the volume and tone depending on the mode selected (see 4,5,6 below).
4. **AUDIO INPUT VOLUME SELECTOR:** Selects Audio Input as the mode for the adjustment knob (3) for the audio sources connected to the audio inputs on the back of the T25.
5. **AUDIO OUTPUT VOLUME SELECTOR:** Selects Audio Output as the mode for the adjustment knob (3) for the audio device connected to the audio output jack on the back of the T25.
6. **TONE SELECTOR:** Selects Tone as the mode for the adjustment knob (3) for the microphone. This adjusts the bass or treble that is heard through the speaker output.
7. **IR RECEIVER:** For pairing to microphone.

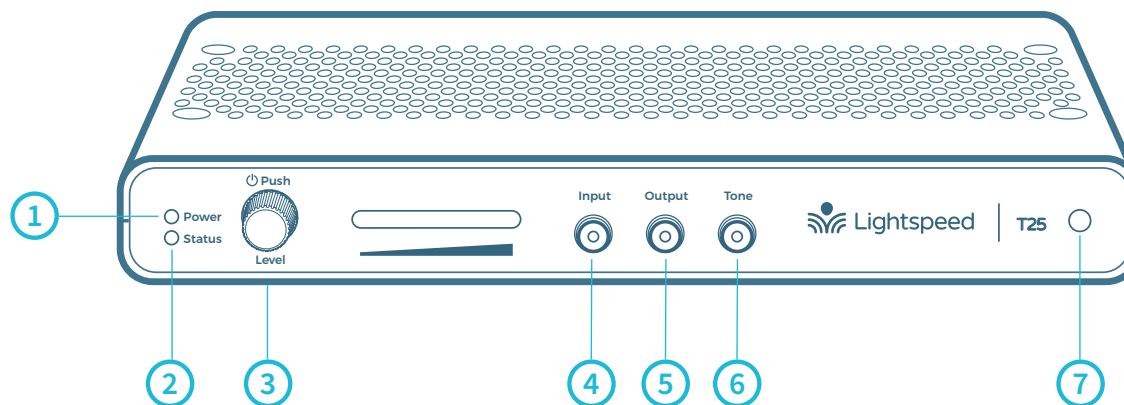



# T25 Controls and Connections

## BACK PANEL

1. **SPEAKER OUTPUTS:** This Euroblock connector is used to connect the T25 to the loudspeaker(s). Up to two 8-ohm speakers can be connected to each output.  
**NOTE:** *Wiring to these terminals should follow the Class 2 wiring methods as outlined in the National Electric Code.*
2. **RJ45 for Wallplate**
3. **AUDIO INPUTS:** 3.5mm stereo connectors for connecting classroom audio sources to be played through audio system.
4. **INPUT PRIORITY:** Additional 3.5 mm stereo connector that automatically mutes other audio inputs when a signal is detected.
5. **AUDIO OUTPUT:** 3.5mm stereo connector for connecting to an assisted listening device (ALD) or to a computer for recording.
6. **S/PDIF RCA:** Digital Audio Input to connect one T25 to another.
7. **PAGEFIRST INPUT:** Connect the input from the optional PageFirst sensor here when interfacing with a building's paging system to mute the T25 during a page.
8. **RELAY INPUT:** Senses external relay closure to mute T25 audio when a signal from a fire alarm, paging system or other device is detected.
9. **CONTACT CLOSURE:** Internal relay contact closure to provide signal to notify external system based on user input.
10. **DC POWER:** Plug the power supply (24V/2.5A) into this jack.

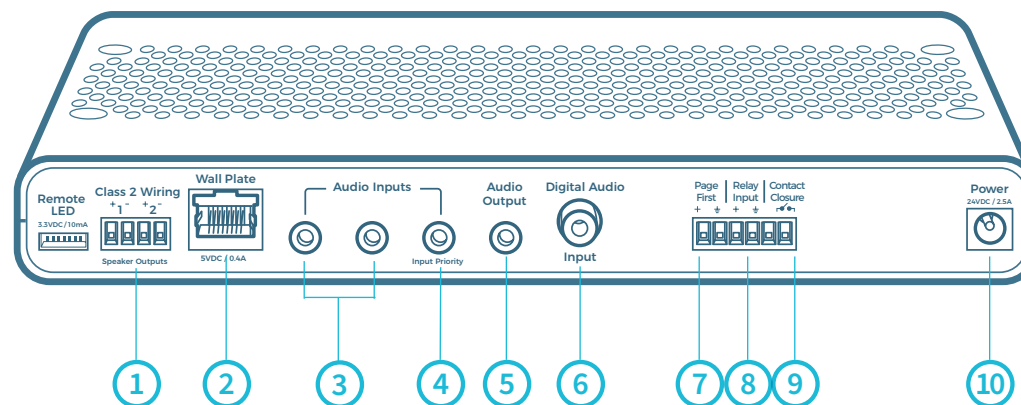



# Clearmike Controls and Connections

1. **POWER/MUTE BUTTON:** Press and hold 1 second to power on. Press and hold for 2 seconds to power off. Tap to mute or talk. Press and hold for 5 seconds to initiate pairing.
2. **IR TRANSMITTER:** For pairing to base unit.
3. **TALK/MUTE LIGHT:** See page 10 for light color descriptions.
4. **POWER STATUS LIGHT:** See page 10 for light color descriptions.
5. **EMERGENCY ALERT BUTTON:** Press and hold 2 seconds to activate alert.
6. **MICROPHONE VOLUME UP/DOWN**
7. **EARBUD/MIC CONNECTION:** For use with optional EMA (earset) or LMA (lapel) microphones..
8. **LANYARD INTERFACE:** Insert the lanyard into this hook to wear the Clearmike.
9. **BATTERY:** Rechargeable battery pack can be replaced by the user.
10. **USB INPUT:** Connect audio source to send to T25. USB input can also be used for charging.

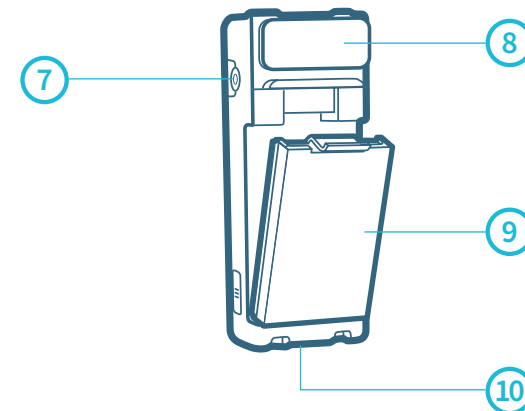
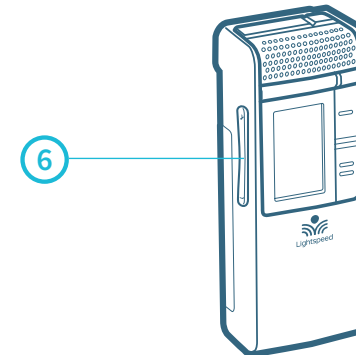
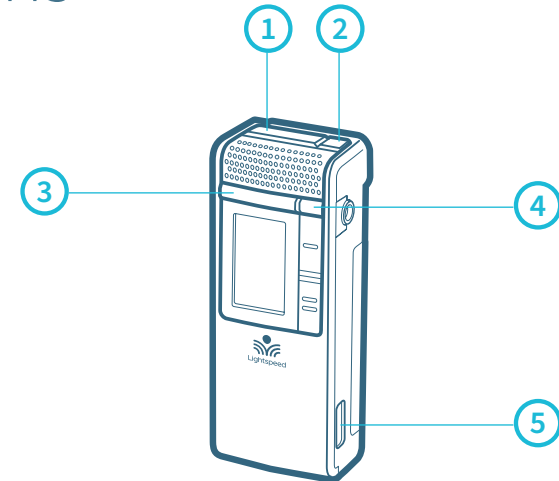



# Microphone Lights

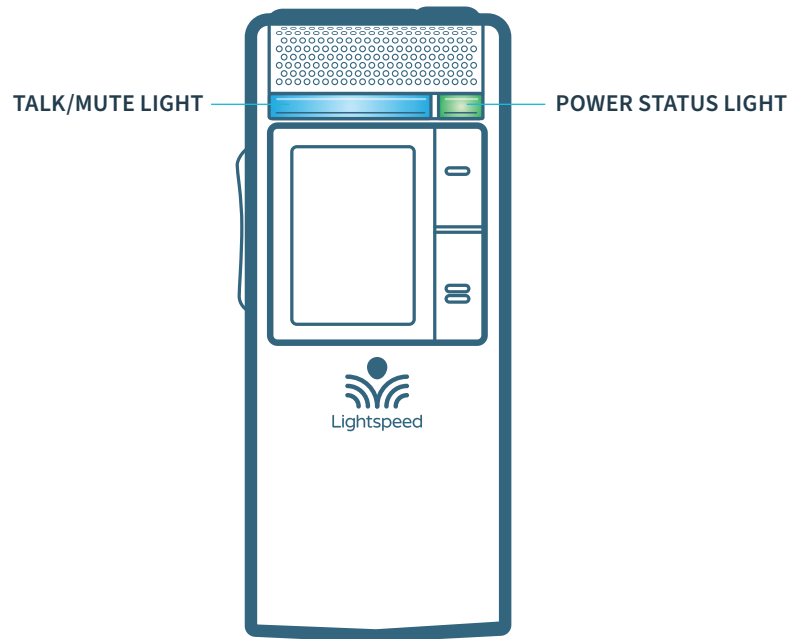

LEFT LIGHT / RIGHT LIGHT



**OFF / OFF:** Mic off or no live link with base



**SOLID WHITE / OFF:** Mute, live link with base



**SOLID BLUE / OFF:** Talk



**ANY COLOR / BLINKING RED:** Low Battery



**BLUE/WHITE ALTERNATING / OFF:** Pairing



**OFF / BLINKING ORANGE:** Firmware update in progress

In Charger:



**OFF / SOLID RED:** Charging



**OFF / SOLID GREEN:** Charged

Plugged into USB:



**SOLID BLUE / SOLID RED:** Charging



**SOLID BLUE / SOLID GREEN:** Charged



# Clearmike Display

## BATTERY INDICATOR

(Full, half, empty)

## MUTE INDICATOR/ VOLUME

## MIC NUMBER (M1 OR M2)

## EXTERNAL MIC DETECTION

The 3.5mm audio jack on the microphone can be used with an earbud or an external microphone.

Plugging in an external mic will disable the internal microphone on the Clearmike

## DEFAULT SCREEN





# Microphone Cradle Charger

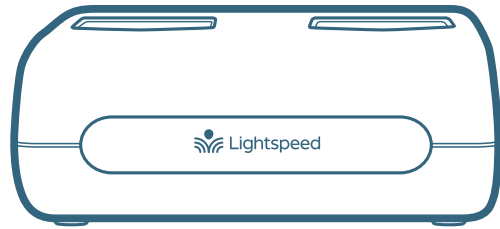

---

**DC POWER PORT:** Connect the 5V/1.0A DC power cord

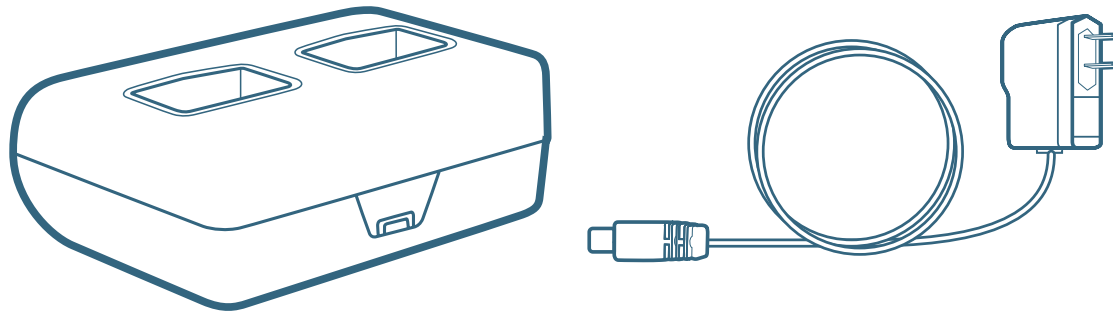



## SET-UP & OPERATION

### Connecting the Power Supply

- Locate the power supply and AC power cord.
- Connect the AC power cord into the DC power supply.
- Insert the DC connector into the “Power” port on T25 and plug the other end to an electrical outlet.
- The T25 automatically powers on and the white Power light on the front panel will turn on.
- A network connection is required for network communication when using the DC power supply.

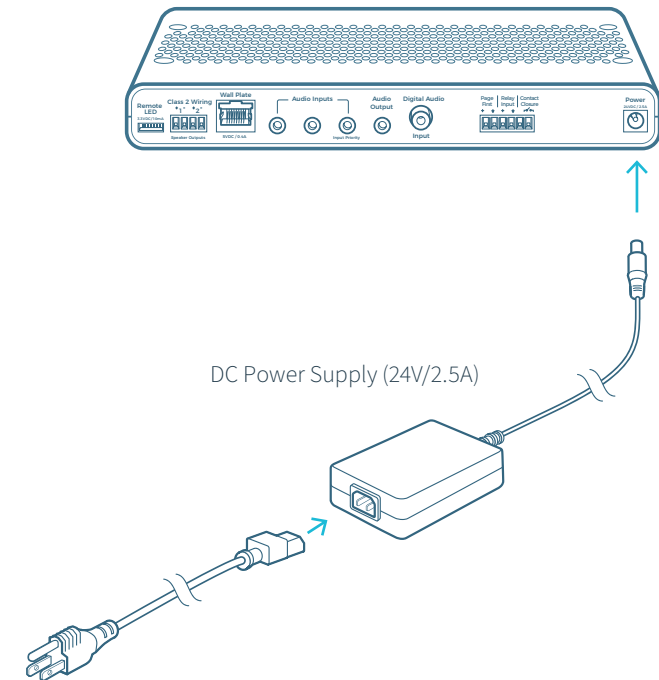



# Charging the Clearmike

## BEFORE USE, THE CLEARMIKE SHOULD BE CHARGED

It will take 5-6 hours for the Clearmike to obtain a full charge. A fully charged Clearmike will last for up to 8 hours of use. If microphones are used daily, they should be charged each night.

Replacement lithium polymer battery packs may only be purchased through Lightspeed (part # L3.7V).

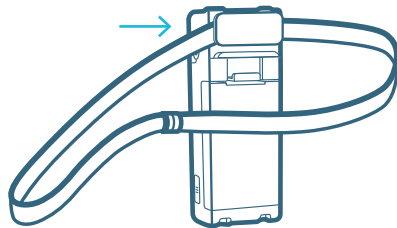

### ATTACH LANYARD

Hang the Clearmike on the lanyard opposite the magnetic clasp.

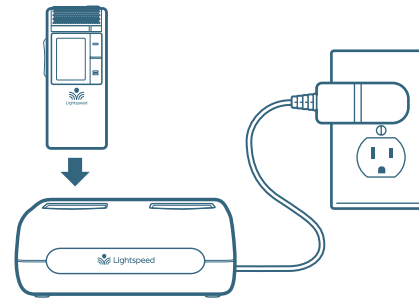

### CONNECT CRADLE CHARGER

Plug power cord into the cradle charger and then plug the AC end into an electrical outlet.

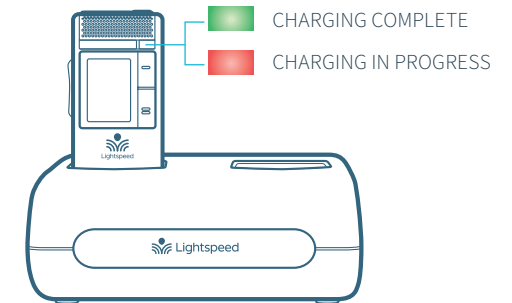

### CHARGE CLEARMIKE

Place the microphones into the cradle charger. The power status light will glow red when it is charging. When charging is complete, the power status light will glow green.

It takes about 5-6 hours to fully charge the microphone battery.



# Setting Up the Clearmike

Once the Clearmike is charged, follow these steps for use.

1. Remove the Clearmike from the charger and put it on by connecting the magnetic clasps behind your neck. Adjust the lanyard so that the top of the Clearmike aligns with the collarbone.
2. The Clearmike will automatically power on and mute when it is removed from the charger.
3. The microphone volume on the Clearmike is set at the factory to the midpoint. It is adjusted by the up/ down buttons on the side of the mic. The volume can only be adjusted while the microphone is in talk mode.
4. While speaking in a normal voice, fine tune the microphone volume. Proper volume level should be as follows:
  - Your voice should be clearly heard by another person on the other side of the room.
  - You should barely be able to hear your own voice.
  - There should not be any audio “feedback” or squealing unless you are too close to a speaker (2-3 feet). If there is, turn the volume down slightly.

**REMEMBER:** This equipment supplements the user’s voice so they are able to speak in a conversational tone. Having the volume set too high will result in feedback and listener fatigue.

- Once initial volume level is set, walk around the room and listen for overall audio quality.
- If further fine tuning is required, you may need to adjust the Tone Control on the front of the T25.

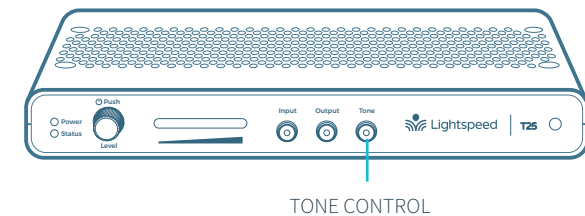
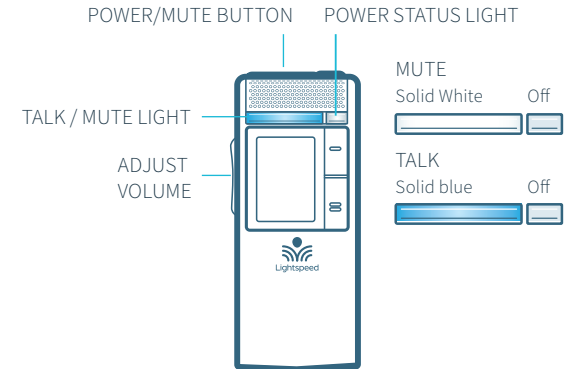
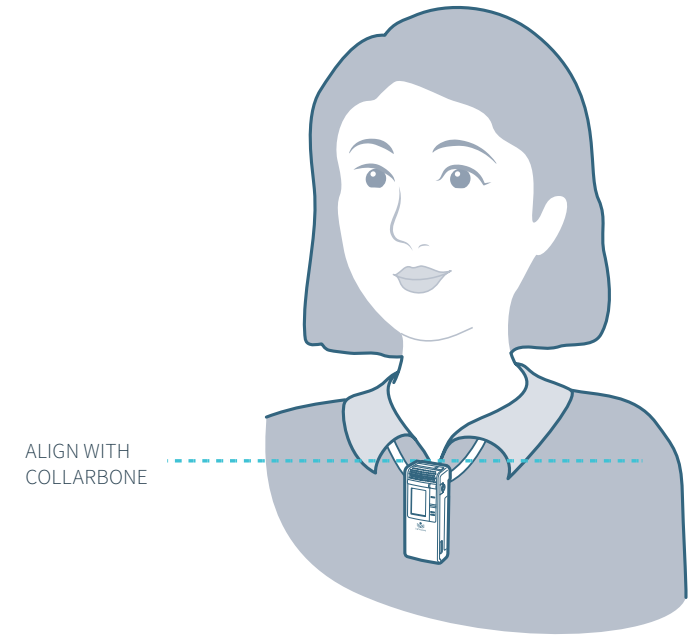



# Daily Use of the Clearmike

## 1. AT THE START OF THE DAY, REMOVE CLEARMIKE FROM THE CHARGER

- The microphone will default to the Mute state, the Talk/Mute light will turn to white.
- Place the microphone around your neck.
- Press the power/mute button. The Talk/Mute light will turn blue, indicating the microphone is active and ready to use.
- Adjust volume with the UP/DOWN buttons if necessary. The volume can only be changed when the microphone is in the Talk state.
- If Clearmike needs to be powered down for some time, press and hold the power button for 2 seconds and release. To power Clearmike again, press and hold the power button until the Talk/Mute light turns white.

## 2. PRIVATE CONVERSATIONS

- Mute the Clearmike during private conversations by momentarily pressing the power button. When muted, the blue light turns white.
- When conversation is over, momentarily press the power button again to unmute the Clearmike.

## 3. END OF DAY

- Place the Clearmike into the cradle charger and make sure the power supply is plugged in to an electrical outlet.
- The T25 will not power down if it has a live link to a microphone. After 60 minutes of audio inactivity, the T25 will automatically power down.
- When Clearmike is removed from charging cradle the next day, it will automatically power on the T25.

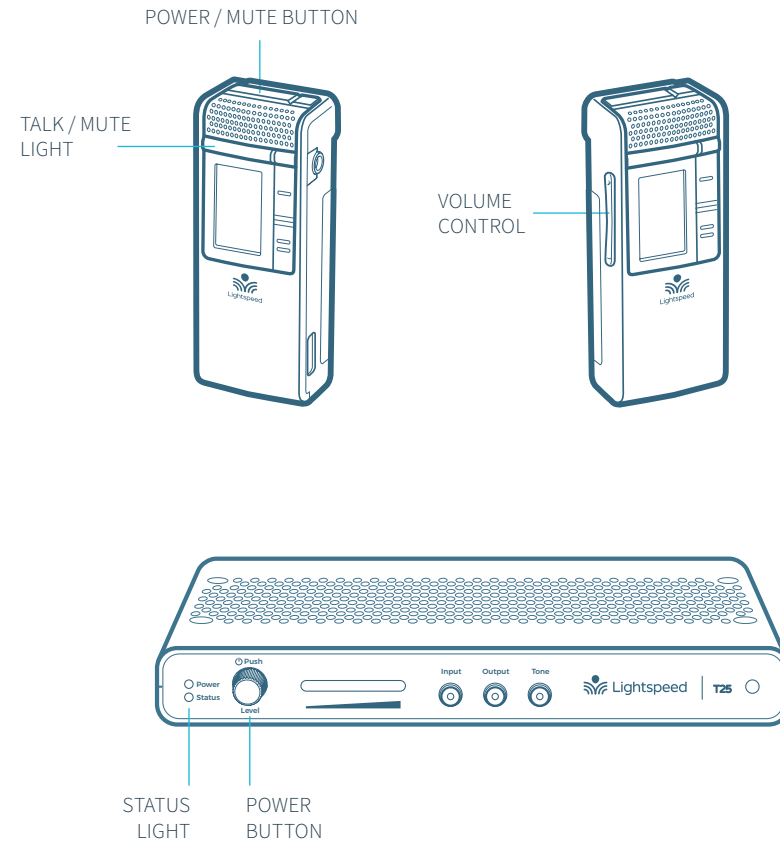



# Pairing your Clearmike



Your system is shipped with microphones and base units pre-paired for quick and easy use.

If for any reason you need to pair new components, follow this pairing process:

**PLEASE NOTE:** All microphones must be out of the charger while pairing.

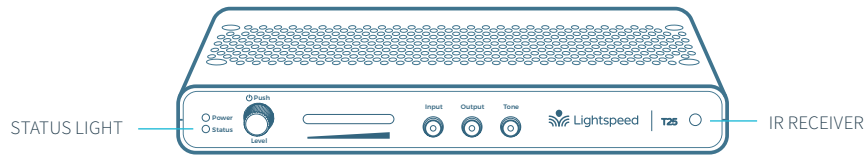

1

With the Clearmike powered off, point the IR transmitter lens toward the T25.

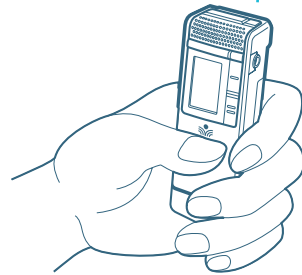

2

Press and hold the Power/Mute button for 5 seconds until the Talk/Mute light starts flashing green and white. The Status light on the T25 will also start flashing green and white.

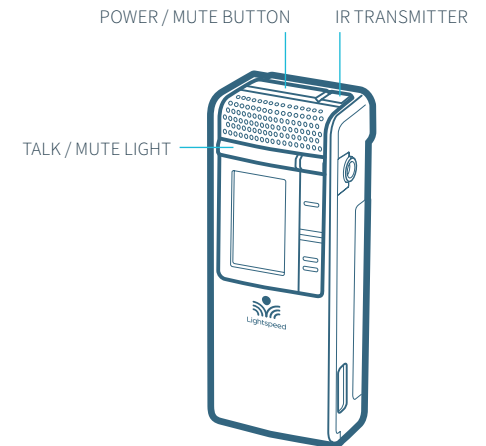

3

When complete, the Status light on the T25 will turn green, the Talk/Mute light on the microphone will be white, and the display on the microphone will say "Pair Success".



# Output Audio to Assistive Listening Device (ALD)

1. Press the Audio Output Selector first, then turn the volume control on the front panel all the way down (fully counterclockwise).
2. Determine the type of audio input jack on the ALD as manufacturers' products differ in connector size and shape. Many require a 3.5 mm to 3.5 mm patch cable (part# MSC3535, not included).
3. Connect a patch cable from the ALD microphone jack or AUX input to AUDIO OUT jack on the back of the T25.
4. With the T25 and ALD turned on, speak into the Flexmike and slowly adjust the corresponding volume control on the T25 until the appropriate audio level is obtained in the ALD.
5. It may be necessary to adjust the volume on the ALD to achieve appropriate volume level.

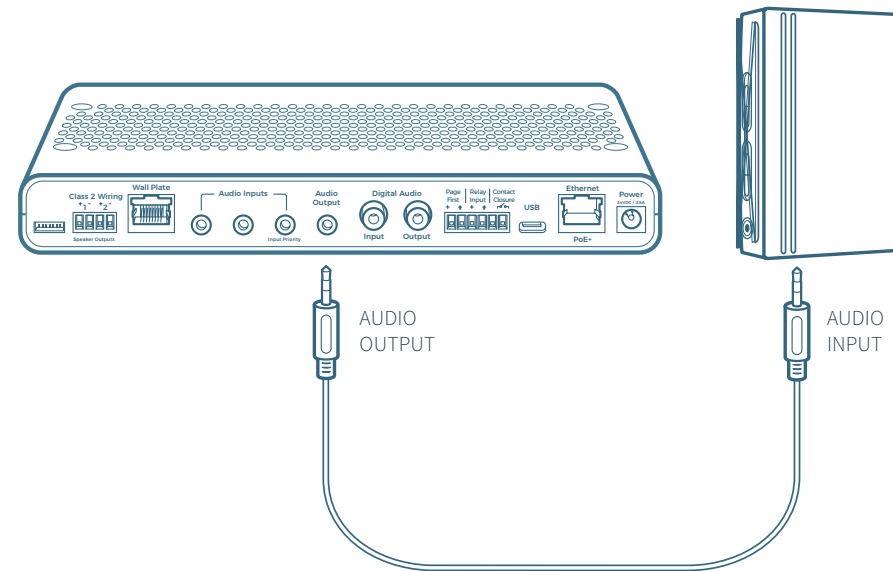



# Using Your Microphone as a Wireless Audio Link

You can connect your 2nd microphone to your computer's USB port to enable a wireless 2-way audio link.

**SEND AUDIO FROM THE COMPUTER** to the T25 to ensure all audio from the computer (videos, video conferencing, audio books, music, etc) can be played through the Lightspeed T25 system and speakers.

**SEND AUDIO TO THE COMPUTER** from the T25 to ensure the teacher's Clearmike and any student microphones are clearly picked up by a video conferencing solution.

1. With a USB-C cable connect your microphone to your computer's USB port.  
This will also power/charge your microphone.
2. Open sound settings on your computer:
  - Select Lightspeed Audio as the Output source to send all computer audio to the T25 system
  - Select Lightspeed Audio as the Input source to use the Lightspeed microphones as the computer microphone audio for video conferencing and recording applications.
3. You may also need to select Lightspeed Audio as the speaker and microphone audio in your video conferencing application the first time you use it.

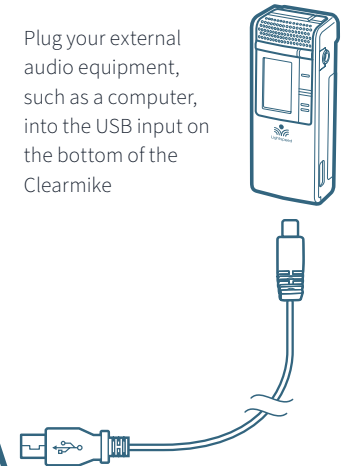
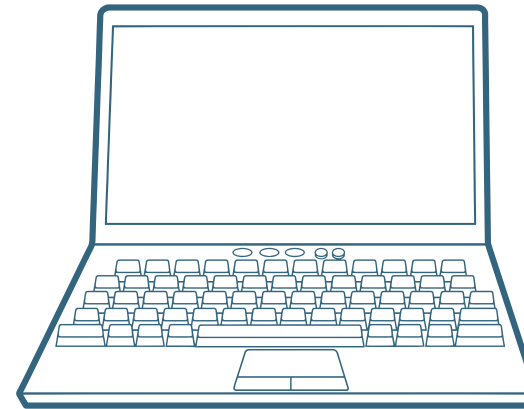

Plug your external audio equipment, such as a computer, into the USB input on the bottom of the Clearmike

USB cable sold separately. Lightspeed offers a USB-A to USB-C cable for sale (part #USBC)



**TIP:** If your system includes two Clearmikes, you can use one mic for instruction and the second mic to transmit audio through the system.



# Audio Integration

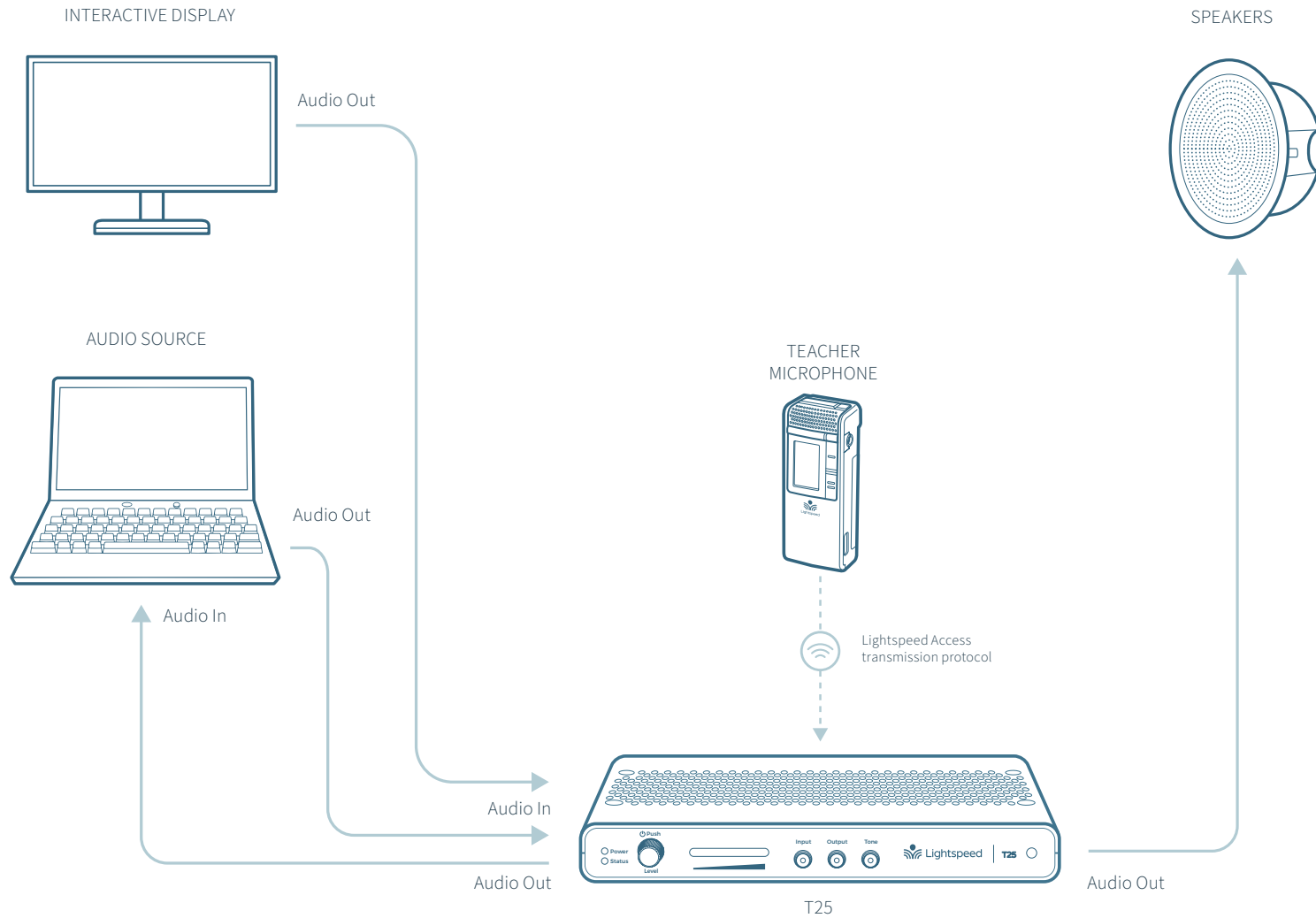



# Analog Control Features

The T25 connects and responds to several important third-party life safety solutions.



## 1. INPUT PRIORITY

MUTES CLASSROOM AUDIO SYSTEM

When an audio source is connected to the Input Priority jack, an audio signal from that source will automatically mute all other audio inputs to allow it to be heard without interference. The T25 is shipped with a removable plug inserted into the Input Priority jack to ensure that the connection to an audio source is intentional.



## 2. PAGEFIRST

MUTES CLASSROOM AUDIO SYSTEM

When the PageFirst sensor clip is connected to an external paging source, all audio signals are muted to ensure paging is heard clearly.

*See page 34 for installation details*



## 3. RELAY INPUT

MUTES CLASSROOM AUDIO SYSTEM

When the T25 is connected to a fire alarm, audio signals going through the unit are muted when the fire alarm is activated to minimize distractions from the sound of the alarm.



## 4. ALERT NOTIFICATION

INITIATES ALERT WITH CLEARMIKE

If your building is equipped with an alert notification system, the T25 and Clearmike can be programmed to initiate a contact closure function. Press and hold the emergency alert button on the side of the Clearmike for two seconds to activate the contact closure. External systems sense this contact closure to perform a prescribed action, notifying the appropriate parties of a classroom alert.

*See page 23 for details*

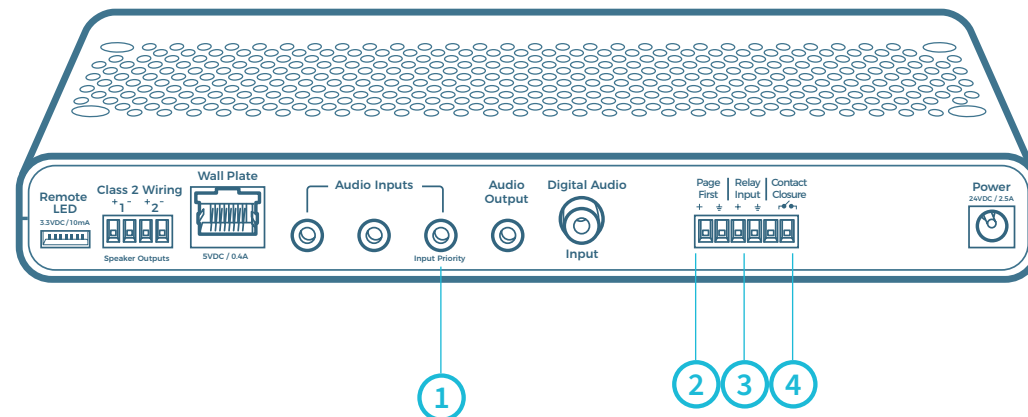



# Installing PageFirst Sensor *(optional)*

This T25 can interface with an independent classroom paging system.

When a page is broadcast, all audio from the system is muted, ensuring important school-wide messages are not missed. Please note that PageFirst is not compatible with telephone or IP-based paging systems.

How it works:

1. PageFirst sensor clip is hung around a lead wire attached to the classroom paging speaker.
2. The clip is hard-wired to the T25.
3. As a page is broadcast, the sensor clip detects the audio signal through induction and immediately mutes the amplifier.
4. When the page is over, the audio from the amplifier returns to normal volume level.

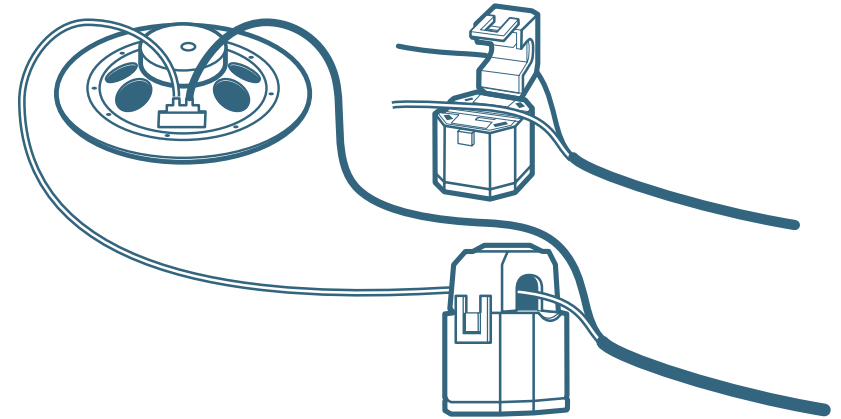

## USING ALERT NOTIFICATION

If your building is equipped with an alert notification system, you can use the Clearmike to send an alert. This activates the contact closure function on the T25, which external systems use to perform a prescribed action, such as notifying the appropriate parties of a classroom alert.



Press and hold the emergency alert button on the side of the Clearmike for two seconds to activate the contact closure.



## OPTIONAL ACCESSORIES

# ShareMike Controls and Connections

- POWER BUTTON**
- POWER STATUS LIGHT**  
**Red light:** During operation, turns red to indicate low battery  
**White light:** Normal operation  
  
When charging in Cradle Charger:  
**Red light:** Charging  
**Green light:** Charging complete
- MIC 1 STATUS:** Lighted to indicate microphone is registered as Mic 1  
**White: solid** = Normal operation  
**White: flashing** = Pairing in process
- MIC 2 STATUS:** Lighted to indicate microphone is registered as Mic 2  
**White: solid** = Normal operation  
**White: flashing** = Pairing in process
- MUTE/TALK STATUS LIGHT**  
**Blue: solid** = Talk  
**White: solid** = Mute
- MICROPHONE VOLUME UP/DOWN**
- USB INPUT:** Connect audio source to send to T25. USB input can also be used for charging.
- IR TRANSMITTER:** For pairing to base unit
- AUDIO INPUT:** Plug a laptop or other audio device into this jack to wirelessly transmit the audio signal to be played through the system.
- VOLUME LOCK:** Disables volume controls.

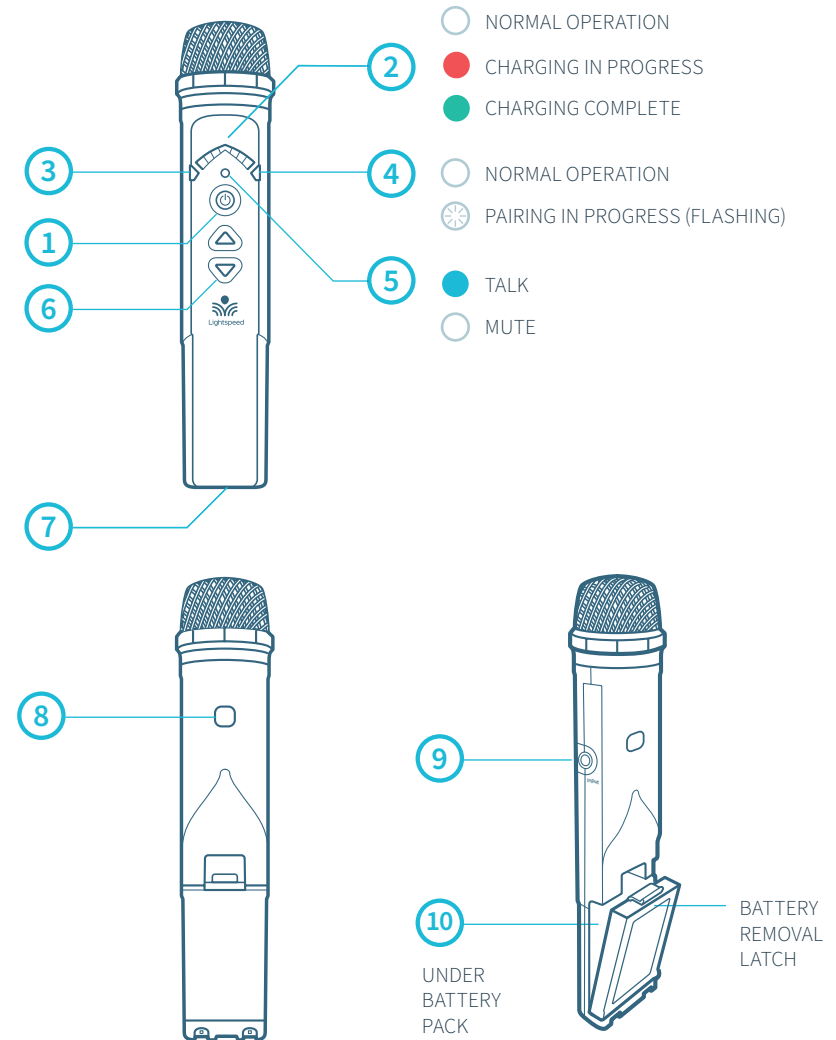



# ShareMike: Charging

1. Make sure the charger is plugged into a wall outlet.
2. The power status light on the microphone will glow red to indicate charging.
3. Leave the ShareMike in the charger overnight to obtain a full charge. It takes about 5-6 hours to fully charge the battery. The light will turn green when charging is complete.

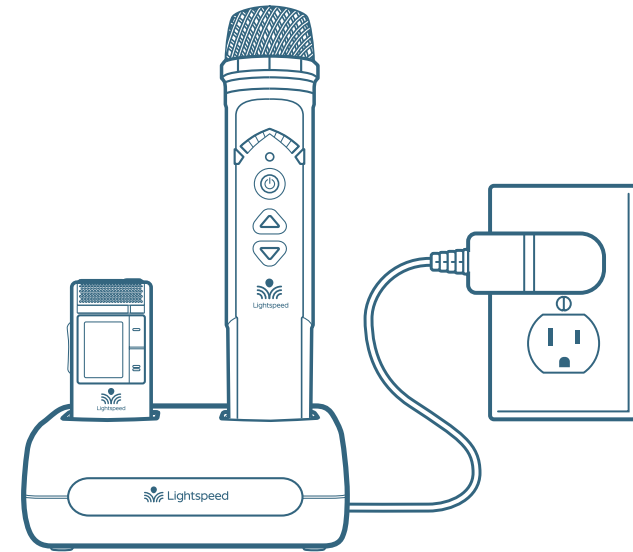
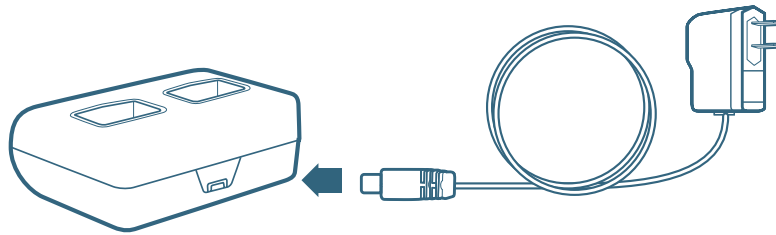

**PLEASE NOTE:** The T25 and microphone(s) are paired together at the factory and all components should be kept together as a system. Moving them from one system, or room, to another will result in the need to re-pair.



# ShareMike: Initial Set-Up

1. Ensure the T25 is on. The white power light will glow.
2. Turn on the ShareMike by pressing and holding the power button until the LED lights.
3. Tap the power button to unmute the microphone. The Mute/Talk light will turn from white to blue.
4. Grip the barrel in the center section.
5. While speaking in a normal voice, increase the volume with the ShareMike until your voice is barely audible.

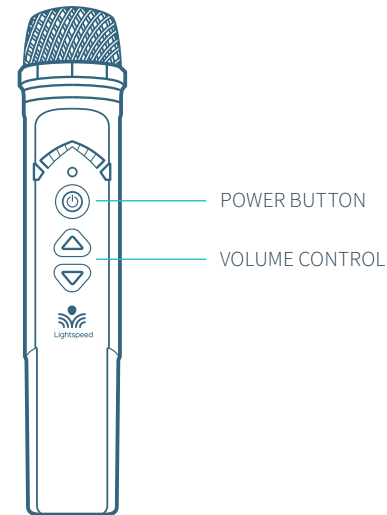
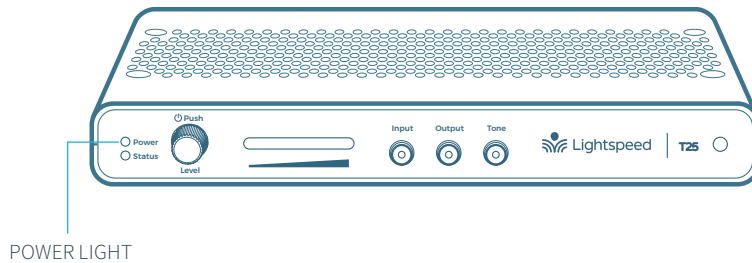

**PLEASE NOTE:** This equipment is designed to supplement and distribute the user's voice so they are able to speak in a conversational tone. Having the volume set too high will result in feedback and listener fatigue.



# Pairing your ShareMike



Your system is shipped with microphones and base units pre-paired for quick and easy use.

If for any reason you need to pair new components, follow this pairing process:

**PLEASE NOTE:** All microphones should be out of the charger while pairing.

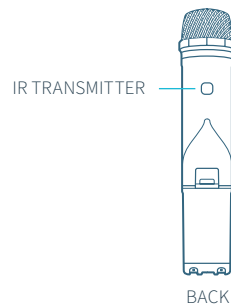
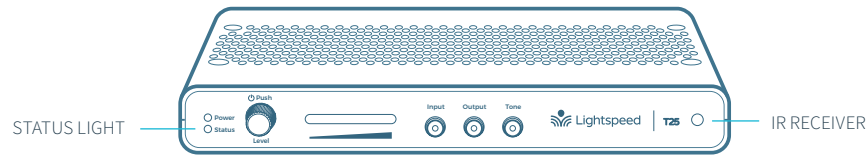

1

From a powered off state, point the IR transmitter lens, located on the back of the microphone, toward the T25.



2

Press and hold the power button for 5 seconds until the mic 1 and mic 2 lights start flashing, then release the button and let the pairing process finish.

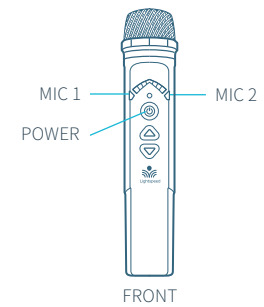

3

The Status light on the T25 will light up indicating the pairing process is complete. The mic 1 or mic 2 light on the microphone will stay illuminated.



# Media Connector Controls and Indicators

## FRONT PANEL

1. **POWER LIGHT**  
**White light:** Power on
2. **POWER BUTTON / VOLUME ADJUSTMENT:** Press and hold this button to turn the system power on or off. This also functions as an adjustment knob for the volume and tone of the paired T25 depending on the mode selected (see 4, 5, 6 below).
3. **STATUS LIGHT:** Media Connector link and pair indicators.  
**Solid white:** Media Connector is paired to the system  
**Off:** Media Connector is not paired to the system
4. **AUDIO INPUT VOLUME SELECTOR:** Selects Audio Input as the mode for the adjustment knob (2) for the audio sources connected to the audio inputs on the back of the Media Connector.
5. **AUDIO OUTPUT VOLUME SELECTOR:** Selects Audio Output as the mode for the adjustment knob (2) for the audio devices connected to the audio outputs on the back of the Media Connector.
6. **tone SELECTOR:** Selects Tone as the mode for the adjustment knob (2) for the microphone. This adjusts the bass or treble that is heard through the classroom speaker.

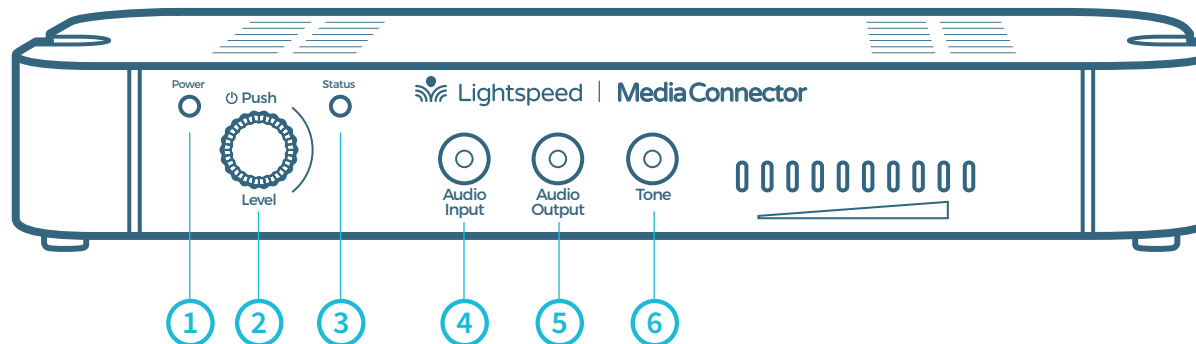



# Media Connector Controls and Indicators

## BACK PANEL

1. **AUDIO INPUTS:** 3.5mm stereo connectors for connecting classroom audio sources to be played through audio system.
2. **AUDIO OUTPUTS:** 3.5mm stereo connectors for connecting to an assisted listening device (ALD) or to a computer for recording.
3. **USB INPUT:** Plug the USB-C end of the power cable into this USB port on the Media Connector.
  - The USB port supplies power to Media Connector when connected to the Media Connector power supply, or from a laptop.
  - It also acts as an input for a digital audio when connected to an audio source. Note that when the USB is used for audio input, the other four audio input jacks are not operational.

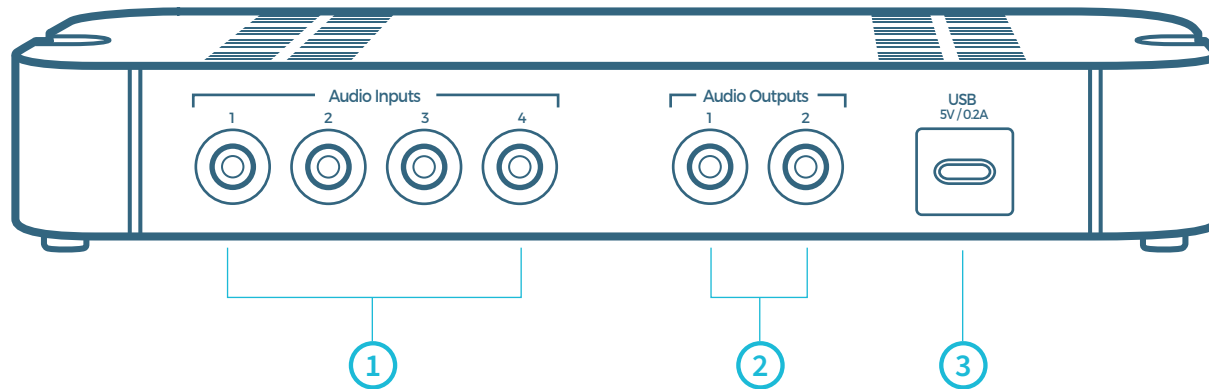



# Media Connector Set Up and Operation

## DETERMINE LOCATION

Media Connector is designed to be connected to the primary media source in the classroom, usually the computer or display panel.

### WALL MOUNT OR DESKTOP

The Media Connector can be placed on a table surface or wall-mounted.

- Choose a location that is convenient to the classroom audio sources and power supply.
- It should be located 3-6 feet off of the floor to allow for good transmission.
- Do not enclose in a metal cabinet or in a location where the signal will be obstructed.

**NOTE:** The Media Connector does not require a direct line of sight to the T25. However it functions best when no obstructions are between the two devices.



## CONNECT TO POWER

Connect the USB power cord to a computer. Plug the USB cable into the USB input on the back of the Media Connector.

OR

Use the USB power adapter to plug into a wall outlet.

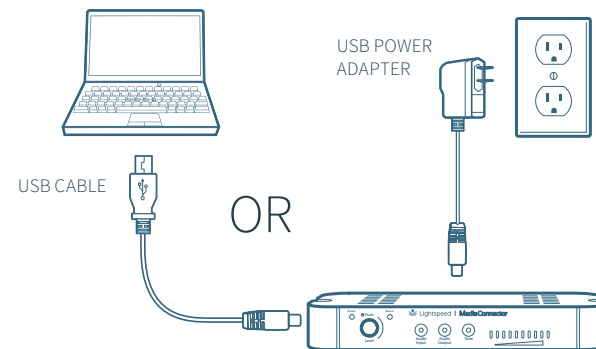



# Connecting Media Connector to Audio

Audio can be connected using either a digital 2-way USB audio or analog audio:

## USB AUDIO

If locating and connecting to computer USB, Media Connector will default to digital USB audio (3.5mm analog audio ports will be disabled). USB audio enables a 2-way audio link to:

**Send audio from the computer to the T25** to ensure all audio can be played through the Topcat speaker.

**Send audio to the computer from the T25** to ensure the teacher's Clearmike and any student microphones are clearly picked up by a video conferencing solution.

## DISABLE/ENABLE USB AUDIO

### TO DISABLE USB AUDIO AND USE COMPUTER USB FOR POWER ONLY

- Unplug USB cable from Media Connector
- Press and hold Audio Output button
- Plug USB cable back to Media Connector
- Status light turns white to indicate USB disabled
- Release Audio Output button and system will reboot with disabled USB-C audio
- Analog Audio Inputs are now active

### TO ENABLE USB AUDIO ON YOUR MEDIA CONNECTOR

- Unplug USB cable from Media Connector
- Press and hold Audio Out button
- Plug USB cable back to Media Connector
- Status light turns blue to indicate USB-C is enabled
- Release Audio Out button and system will reboot with enabled USB-C audio
- Analog Audio Inputs are now inactive

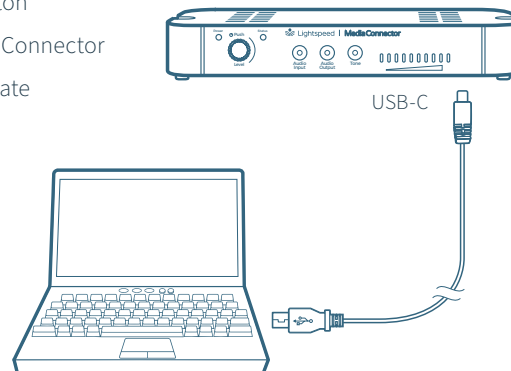

## ANALOG AUDIO

Plug your external audio equipment (e.g., video display) into one of the Audio input jacks.

Adjust the volume as needed by pressing the Audio Input selector and adjusting the level knob as needed.

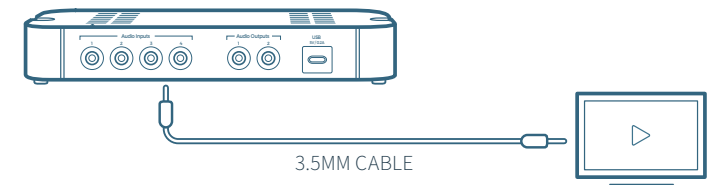

## COMPUTER SETTINGS

Once connected, open computer sound setting to select "Lightspeed Audio" as the microphone and speaker.



## SETTING THE VOLUME LEVELS

For recording, or to interface with an Assistive Listening Device, connect a 3.5mm cable to the Audio Output of the Media Connector to the microphone input on the device. Press the button for the desired level adjustment.

- Turn the knob to adjust volumes up or down for Audio Input/Output
- To adjust the Tone (bass/treble) of the speaker, press Tone and use the adjustment knob to turn the bass up and down



# Pairing T25 to Media Connector



Your system is shipped with microphones and base units pre-paired for quick and easy use. If for any reason you need to pair new components, follow this pairing process:

**PLEASE NOTE:** Microphones should be out of the charger while pairing.

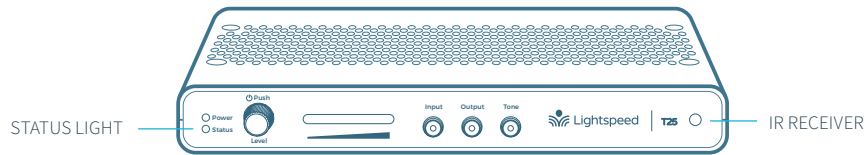

1

With the microphone turned on, point the IR transmitter lens toward the T25 (for ShareMike, the transmitter lens is located on the back of the microphone).

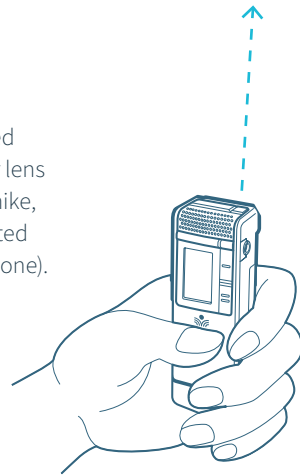

2

Press and hold the Clearmike power button for 5 seconds until the status light on the T25 starts flashing, then release the button. At this point, the status light on T25 will blink for 30 seconds.

If after 30 seconds the status light blinks rapidly, you will need to start the pairing process again.

POWER IR TRANSMITTER



CLEARMIKE

3

On the Media Connector, press and hold the Tone Selector button for 5 seconds to put it into pairing mode.

When the status lights are solid on both the T25 and Media Connector, pairing is successful.

MEDIA CONNECTOR

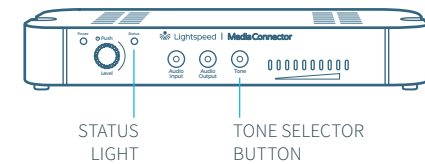



## MAINTENANCE & TROUBLESHOOTING

# Clearmike Battery Replacement

### BATTERY PART #L3.7V

1. Push down on the latch and carefully pull the battery pack away from the Clearmike.
2. Insert new battery pack as shown and make sure the latch is secure.
3. Place the Clearmike in a cradle charger to charge the battery pack.

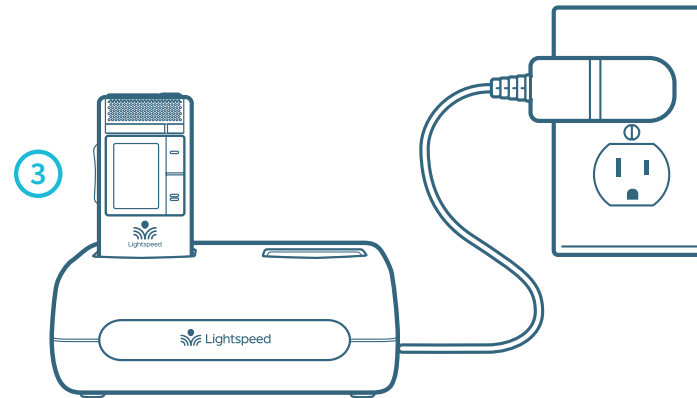
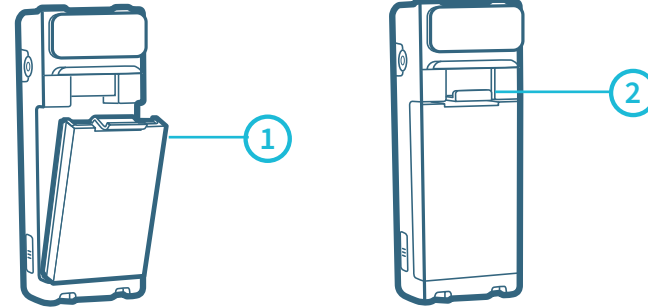

**PLEASE NOTE:** Lithium-ion batteries should not go in household garbage or recycling bins. Lithium-ion batteries should be taken to separate recycling or household hazardous waste collection points.



# ShareMike Battery Replacement

## BATTERY PART #L3.7V

1. Push down on the latch and carefully pull the battery pack away from the ShareMike.
2. Insert new battery pack as shown and make sure the latch is secure.
3. Place the ShareMike in a cradle charger to charge the battery pack.

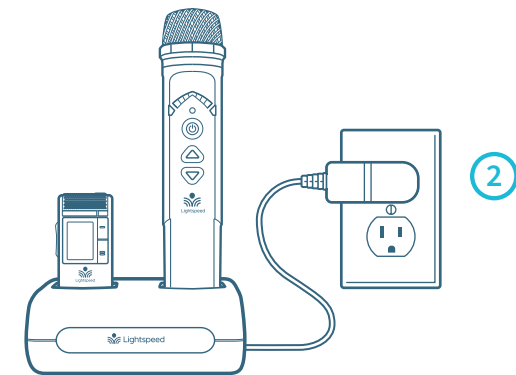
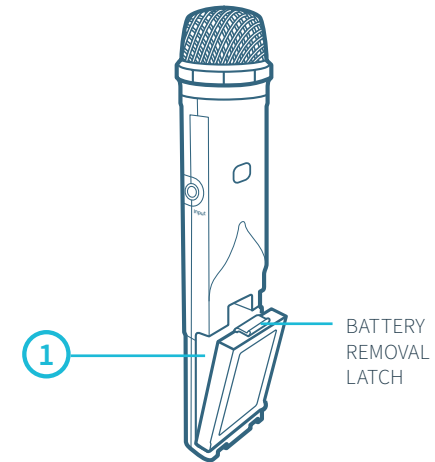

**PLEASE NOTE:** Lithium-ion batteries should not go in household garbage or recycling bins. Lithium-ion batteries should be taken to separate recycling or household hazardous waste collection points .



# Troubleshooting

**PROBLEM: Low battery indication:** Most problems are directly related to low battery power. Please run through the “Battery Check” items first. For remaining troubleshooting, use known good, fully-charged batteries.

**SOLUTION:** Battery Check

- Confirm batteries are charged each night. A blinking red status light on the Clearmike and a solid red status light on the Sharemike indicates a low battery.
- Confirm proper batteries are used: Clearmike and Sharemike require the Lightspeed #L3.7V rechargeable battery pack.
- Make sure the microphones obtain a full charge. A full charge takes 5-6 hours.
- When charging the transmitter, the red charging light is solid. The green light will be solid when a full charge is reached.

**PROBLEM: Microphone doesn’t indicate a “Ready” signal (solid white light)**

**SOLUTION:** Follow these steps to ensure the system is ready to use.

- Power cycle the microphone using either the Power/Mute button or by placing in a charger and then removing it. Wait for up to 30 seconds for the white light to turn solid, indicating READY for operation.

**PROBLEM: Low volume or feedback**

**SOLUTION:** Follow these steps to eliminate low volume or feedback:

- If the volume is too high, feedback will occur. Adjust accordingly.
- Adjust the volume level on the Clearmike or move the microphone further from the audio system speakers.

**PROBLEM: No sound from speaker and wireless components**

**SOLUTION:** Follow these steps to produce sound from T25:

- Confirm that the white POWER light located on the front panel of the T25 is on.
- Confirm the microphone is powered on and linked to the T25. The Talk/Mute light will be white indicating the microphone is linked.
- Tap the Power/Mute button to confirm that microphone is not muted. The Talk/Mute light on the front of the microphone will be solid blue indicating microphone is not muted.
- Check speaker connections on the T25. Make sure the cables are properly connected (see page 8 of this manual or the Installation Guide for more information).
- Slowly turn up the volume level while talking into the microphone.

**If you still have questions after reviewing these instructions, call Lightspeed Technical Services at 800.732.8999, 5am–5pm, PST.**

Customers outside the U.S. should contact their local reseller.



# Tips for Optimum Audio Performance

- **Speak in a natural voice.** A normal conversational speech level will provide an adequate signal. It is not necessary to increase the intensity of your voice the audio system provides adequate amplification (approximately 5–10 dB) above ambient room noises.
- Avoid **wearing jewelry** that may rub or bump against the microphone.
- **Mute the microphone** during private conversations with a student, parent, or other classroom visitor. You can tell the mic is muted when the light turns white.
- **Recharge microphones each night.** When recharged nightly, operating time (actual usage) for the microphones will last through a typical school day.



## WARRANTY, SAFETY & SPECIFICATIONS

### Five-Year Limited Warranty

Lightspeed Classroom Audio Systems are guaranteed against malfunction due to defects in materials and workmanship for a period of five (5) years, beginning at the date of the purchase invoice. If such malfunction occurs, the product will be repaired or replaced (at Lightspeed's option) without charge during the warranty period.

Lightspeed's Warranty Exchange Program applies to all classroom audio systems within the five (5) year warranty period. If a classroom audio product or component has an issue that requires service, a refurbished replacement will immediately be sent to the customer to minimize downtime. Customers will receive the exchange product(s) or component(s) within 2-3 days. A prepaid return label will be included with exchanged products so original malfunctioned equipment can be returned to Lightspeed. Any exchanged equipment will remain covered under the original five-year warranty.

1. Warranty for T25 is five (5) years.
2. Warranty on Lightspeed NiMH and Lithium Polymer rechargeable batteries is one (1) year.
3. Warranty on microphones and components that support discontinued systems (FMA, SMA and FMCA) is one (1) year.
4. A prepaid shipping label will be provided by Lightspeed for warranty repairs within the United States. Customers outside the U.S. should refer to the Lightspeed website ([www.lightspeed-tek.com](http://www.lightspeed-tek.com)) for warranty repair instructions.
5. Warranty does not extend to finish, appearance items, or malfunctions due to abuse or operation other than specified conditions, nor does it extend to incidental or consequential damages. Repair by other than Lightspeed or its authorized service agencies will void this warranty. Information on authorized service agencies is available from Lightspeed Technologies, Inc.

**Our Service Department (800.732.8999, 5am–5pm, PST) will handle your repair or replacement needs.**

Customers outside the U.S. should contact their local reseller.



# Safety Warnings and Certifications *(Pending Approval)*

**CAUTION**

**RISK OF ELECTRICAL SHOCK**

**DO NOT OPEN**

**THIS PRODUCT MUST BE INSTALLED IN ACCORDANCE WITH THE APPLICABLE INSTALLATION CODE BY A PERSON FAMILIAR WITH THE CONSTRUCTION AND OPERATION OF THE PRODUCT AND THE HAZARDS INVOLVED.**

**The lightning flash** with arrowhead symbol inside an equilateral triangle is intended to alert the user to the presence of non insulated “hazardous voltage” within the product’s enclosure, which may be of sufficient magnitude to induce a risk of electric shock to persons.

**The exclamation mark** inside an equilateral triangle is intended to alert the user to the presence of important operating and maintenance (servicing) instruction in the literature accompanying this product.

- USE A LIGHTSPEED SUPPLIED BATTERY ONLY**
- CAUTION: Risk of explosion if battery is replaced by an incorrect type. Dispose of used batteries according to the instructions.
- Battery subjected to extremely low air pressure that may result in an explosion or the leakage of flammable liquid or gas.
- Wall mount using #8 screws with a minimum head diameter of 0.3 inches, in all four mounting holes.
- Use only with one of these power supplies:

<b>Manufacturer</b>	<b>Model</b>
Dee Van Enterprise Co Ltd (Lightspeed)	DSA-60PFG-24 1 240250
GlobTek, Inc.	GTM96600-6024-T3
GlobTek, Inc.	GTM96600-6524-T3

## CERTIFICATIONS



This product is listed to UL standards and requirements for electrical safety by Underwriters Laboratories Inc.



This product conforms with the essential requirements of the following European Union Directives: 2004/108/EC Electromagnetic Compatibility (EMC) and 2006/95/EC Low Voltage Directive (LVD).



Lightspeed Technologies launched a formal product recycle program in Europe that complies with the European Union Directive 2002/96/EC on Waste Electrical and Electronic Equipment (“WEEE Directive”). Please visit [www.lightspeed-tek.com](http://www.lightspeed-tek.com) for more information.



This product is manufactured using lead-free processes and is free of other materials harmful to the environment. It conforms to the most stringent new European guidelines for consumer products (RoHS).



# Précautions De Sécurité et Certifications



**ATTENTION**

**RISQUE D'ÉLECTROCUTION**

**NE PAS OUVRIR**



CONFORMÉMENT AUX NORMES D'INSTALLATION APPLICABLES, CE PRODUIT DOIT ÊTRE INSTALLÉ PAR UNE PERSONNE FAMILIARISÉE AVEC LA CONCEPTION ET LE FONCTIONNEMENT DU PRODUIT ET CONSCIENTE DES RISQUE ENCOURUS.



**L'éclair flèche** dans un triangle équilatéral avertit l'utilisateur de la présence d'une "tension dangereuse" non isolée à l'intérieur de l'appareil, qui peut être d'une ampleur suffisante pour constituer un risque d'électrocution.



**Le point d'exclamation** contenu dans un triangle équilatéral avertit l'utilisateur de la présence d'importantes instructions d'exploitation et de maintenance dans la documentation qui accompagne ce produit.



UTILISEZ UNIQUEMENT LA BATTERIE LIGHTSPEED FOURNIE



ATTENTION: Risque d'explosion si la batterie est remplacée par un type incorrect. Mettre au rebut les batteries usagées selon les instructions.



Batterie soumise à une pression d'air extrêmement faible pouvant entraîner une explosion ou une fuite de liquide ou de gaz inflammable.



Montage mural à l'aide de #8 vis avec un diamètre de tête minimum de 0.3 pouces, dans les quatre trous de montage.



À utiliser uniquement avec l'une de ces alimentations :

**Fabricant**

Dee Van Enterprise Co Ltd (Lightspeed)  
 GlobTek, Inc.  
 GlobTek, Inc.

**Modèle**

DSA-60PFG-24 1 240250  
 GTM96600-6024-T3  
 GTM96600-6524-T3

## CERTIFICATIONS



Ce produit est certifié conforme aux normes et aux exigences UL en matière de sécurité électrique par Underwriters Laboratories Inc.



Ce produit est conforme aux principales exigences des directives de l'Union Européenne suivantes : 2004/108/EC Electromagnetic Compatibility (EMC) and 2006/95/EC Low Voltage Directive (LVD).



Lightspeed Technologies a lancé un programme de recyclage de produits en Europe conformément à la directive de l'Union Européenne 2002/96/CE relative aux déchets d'équipements électriques et électroniques (directive « DEEE »). Veuillez visiter notre page Web [www.Lightspeed-tek.com](http://www.Lightspeed-tek.com) pour plus de renseignements.



Ce produit est fabriqué en utilisant des processus sans plomb ni aucune autre matière nuisible à l'environnement. Il est conforme aux nouvelles règles européennes les plus strictes en matière de biens de consommation (RoHS).



# FCC Statements

## FCC STATEMENTS

**NOTE:** This device complies with part 15 of the FCC Rules. Operation is subject to the following two conditions: (1) This device may not cause harmful interference, and (2) this device must accept any interference received, including interference that may cause undesired operation.

**NOTE:** LightSpeed Technologies is not responsible for any changes or modifications not expressly approved by the party responsible for compliance. Such modifications could void the user's authority to operate the equipment.

**NOTE:** This equipment has been tested and found to comply with the limits for a Class B digital device, pursuant to part 15 of the FCC Rules. These limits are designed to provide reasonable protection against harmful interference in a residential installation. This equipment generates, uses and can radiate radio frequency energy and, if not installed and used in accordance with the instructions, may cause harmful interference to radio communications. However, there is no guarantee that interference will not occur in a particular installation. If this equipment does cause harmful interference to radio or television reception, which can be determined by turning the equipment off and on, the user is encouraged to try to correct the interference by one or more of the following measures:

- Reorient or relocate the receiving antenna.
- Increase the separation between the equipment and receiver.
- Connect the equipment into an outlet on a circuit different from that to which the receiver is connected.
- Consult the dealer or an experienced radio/TV technician for help.

**NOTE:** This equipment complies with FCC radiation exposure limits set forth for an uncontrolled environment. This equipment should be installed and operated with minimum distance 20cm (8") between the radiator & your body



# Canada, Industry Canada (IC) Notices

This device complies with Industry Canada license exempt RSS standard(s). This Class B digital apparatus complies with Canadian ICES-003 and CAN ICES-3(B)/NMB-3(B). Operation is subject to the following two conditions: (1) this device may not cause interference, and (2) this device must accept any interference, including interference that may cause undesired operation of the device. The IC number for this device is 1732B-LST25. This includes accessories such as the Clearmike (IC 1732B-LSCMT), Sharemike (IC 1732B-LSSMN) and Media Connector (IC 1732B-LSMCN).

This equipment complies with IC radiation exposure limits set forth for an uncontrolled environment. This equipment should be installed and operated with a minimum distance of 20 cm between the radiation source and your body.

## **RF RADIATION EXPOSURE STATEMENT**

Your microphone is a radio transmitter and receiver. It is designed not to exceed the limits for exposure to radio waves (radio frequency electromagnetic fields) recommended by international guidelines. The guidelines were developed by Health Canada and include a substantial safety margin designed to assure the safety of all persons, regardless of age and health.

# Canada, Avis d'Industrie Canada (IC)

Cet appareil numérique de classe B est conforme aux normes canadiennes ICES-003 et RSS-247. Son fonctionnement est soumis aux deux conditions suivantes: (1) cet appareil ne doit pas causer d'interférence et (2) cet appareil doit accepter toute interférence, notamment les interférences qui peuvent affecter son fonctionnement. Le numéro IC de cet appareil est 1732B-LST25. Ceci inclus les accessoires comme le Clearmike (IC 1732B-LSCMT), Sharemike (IC 1732B-LSSMN) et un Media Connector (IC 1732B-LSMCN).

Cet équipement est conforme aux limites d'exposition aux rayonnements IC établies pour un environnement non contrôlé. Cet équipement doit être installé et utilisé avec un minimum de 20 cm de distance entre la source de rayonnement et votre corps.

## **DÉCLARATION D'EXPOSITION AUX RAYONNEMENTS RF**

Votre pied de micro est un émetteur-récepteur radio. Il est conçu pour ne pas dépasser les limites d'exposition aux ondes radio (champs électromagnétiques de fréquence radio) recommandées par les directives internationales. Les lignes directrices ont été élaborées par Santé Canada et comprennent une marge de sécurité importante destinée à assurer la sécurité de toutes les personnes, indépendamment de l'âge et de la santé.



# EU Declaration of Conformity

According to EU Directives EMC 2014/30/EU, LVD 2014/35/EU, RED 2014/53/EU, RoHS 2011/65/EU

**Manufacturer:** Lightspeed Technologies, Inc.

**Address:** 11509 SW Herman Rd.  
Tualatin, Oregon 97062

*We herewith declare that the following systems comply with the appropriate basic safety and health requirements of the Directive based on its design and type, as brought into circulation by us. In case of alteration of the system, not agreed upon by us, this declaration will lose its validity.*

**Products:** Redcat, Topcat, 975, Access Link, Flexmike, Sharemike, Pod, Activate Station, Media Connector, Mobile PA

**Model Numbers:** RCN, TCN, 975, ALN, FMN, SMN, POD, ACT, MCN, MPA

As applicable, products conform to the standards listed below:

EN 62368-1:2014

IEC 62133:2012

EN 50385:2017

EN 50566:2017

EN 50663:2017

EN 62479:2010

ETSI EN 301 406 V2.2.2 (2016-09)

ETSI EN 301 489-1 V2.2.3 (2019-11)

ETSI EN 301 489-6 V2.2.1 (2019-04)

EN IEC 63000:2018

The Technical Construction File is available to proper authorities and the product is CE marked.

Lightspeed Representative

Date: December 6, 2022

Michael Frost, Compliance Engineer



# EU Declaration of Conformity

In accordance with EU Directive and Regulations

**Manufacturer:** Lightspeed Technologies, Inc.  
**Address:** 11509 SW Herman Rd.  
Tualatin, Oregon 97062

*As the manufacturer hereby declares under our sole responsibility that the*

**Product(s):** *Wireless Audio Hub and Microphone*

**Model:** *Cascadia C25 and T25*

*is in conformity with the essential requirements of the RE Directive 2014/53/EU:*

**Radio Article:** FCC 47 CFR Part 15D  
FCC 47 CFR Part 15C  
FCC 47 CFR Part 15B  
RSS-213, Issue 3, 2015-03  
RSS-Gen, Issue 5, 2018-04  
ANSI C63.17 :2013  
ANSI C63.4 :2014

**Safety Article:** IEC 62368-1: 2018

We hereby declare that [all essential radio test suites have been carried out and that] the above-named product is in conformity to all the essential requirement of Directive 2014/53/EU.

Lightspeed Representative

Date: April 11, 2025

Zachary Heise, Technical Program Manager

503.218.1216

zach.heise@lightspeed-tek.com

11509 SW HERMAN RD

Tualatin OR 97062, USA



# FCC Suppliers Declaration of Conformity (Sdoc)

**Manufacturer:** Lightspeed Technologies, Inc.

**Address:** 11509 SW Herman Rd.  
Tualatin, Oregon 97062

*We declare that the SDoC is issued under our sole responsibility and belongs to the following the products:*

**Model Number:** TCC

**Intended Use:** Instructional Audio

The object of the declaration described above is in conformity with the relevant code of Federal Regulations:

Title 47 CFR Part 15 Radio Frequency Devices

**FCC Compliance Statement:**

This device complies with part 15 of the FCC Rules. Operation is subject to the following two conditions:

- (1) This device may not cause harmful interference, and
- (2) this device must accept any interference received, including interference that may cause undesired operation.

Lightspeed Representative

A handwritten signature in black ink, appearing to read "Michael Frost".

Michael Frost, Compliance Engineer

Date: December 6, 2024



# System Components

## STANDARD COMPONENTS

<b>T25</b>	Wireless audio base station
<b>24V-2.5A-NA</b>	24V/2.5A power supply for T25
<b>FSCC</b>	Transceiver cradle charger, power supply
<b>5V1C</b>	5V power supply for FSCC
<b>CMT</b>	Clearmike classroom transceiver with battery pack and lanyard
<b>L3.7V</b>	Lithium Polymer rechargeable battery pack for Clearmike, one per Flexmike
<b>FL</b>	Microphone lavalier cord
<b>SPEAKERS</b>	As ordered

## STANDARD COMPONENTS (OUTSIDE U.S. AND CANADA)

<b>T25G</b>	Wireless audio base station
<b>24V-2.5A</b>	24V/2.5A power supply for T25, specify country
<b>FSCC -INT</b>	Transceiver cradle charger, power supply
<b>5V1C -INT</b>	International 5V power supply for FSCC
<b>CMTG</b>	Clearmike classroom transceiver with battery pack and lanyard
<b>L3.7V</b>	Lithium Polymer rechargeable battery pack for Clearmike, one per Clearmike
<b>FL</b>	Microphone lavalier cord
<b>SPEAKERS</b>	As ordered

## OPTIONAL ACCESSORIES

<b>SMN</b>	Sharemike handheld transceiver with battery pack
<b>L3.7V</b>	Lithium Polymer rechargeable battery pack for Sharemike
<b>USB C</b>	Charging cable for Sharemike
<b>EMA</b>	Earsset microphone with TRRS connector for Clearmike
<b>LMA</b>	Lapel microphone with TRRS connector for Clearmike
<b>MCN</b>	Media Connector with Access Technology, power adapter and power cord.



# System Specifications

## T25

<b>Description</b>	Wireless audio hub
<b>Wireless Communication</b>	Access Technology (1.9 GHz)
<b>Frequency Response</b>	20 Hz - 20 kHz Power Amp, 150 Hz - 6.5 kHz Wireless
<b>Power Supply Options</b>	24VDC/2.5A
<b>Power Output</b>	40 WRMS total (20 WRMS/channel) with 24VDC supply
<b>Tone Control</b>	Bass/Treble control
<b>Audio Inputs</b>	Three (3) 3.5mm inputs, one S/PDIF coaxial digital input
<b>Audio Output</b>	One (1) 3.5mm output
<b>Max Input/Output Level</b>	1.4VRMS / 1.4VRMS
<b>Total Harmonic Distortion</b>	<1%
<b>Analog Control Signals</b>	Inputs: PageFirst (25/70V page mute), Relay Input Output: Contact closure (initiated from microphone)
<b>Dimensions (W x H x D)</b>	9.0" x 6.1" x 1.2" (229mm x 155mm x 30mm)
<b>Weight</b>	17.5 oz (496g)

## CLEARMIKE

<b>Description</b>	Pendant-style transceiver
<b>Earbud Lanyard</b>	Magnetic clasp with integrated earbud
<b>Wireless Communication</b>	Access Technology (1.9 GHz)
<b>Integrated Microphone</b>	Uni-directional electret
<b>Analog Audio I/O</b>	3.5mm TRRS
<b>Digital Audio I/O</b>	USB-C
<b>Control Buttons</b>	Power/mute, volume up/down, alert
<b>Volume Control</b>	+/- 12dB
<b>Total Harmonic Distortion</b>	<1%
<b>Display</b>	E-paper display
<b>Battery Power</b>	3.7V LiPo battery pack
<b>Battery Life</b>	8 hours (fully charged)
<b>Charging</b>	Cradle charger or USB-C
<b>Dimensions (L x W x H)</b>	3.0" x 1.2" x 0.9" (76mm x 30mm x 23mm)
<b>Weight</b>	1.3 oz (37g)

## SHAREMIKE

<b>Description</b>	Handheld transceiver
<b>Wireless Communication</b>	Access Technology (1.9 GHz)
<b>Total Harmonic Distortion</b>	<1%
<b>Integrated Microphone</b>	Uni-directional electret
<b>Audio input</b>	3.5mm TRS
<b>Battery Power</b>	3.7V LiPo battery pack
<b>Battery Life</b>	8 hours (fully charged)
<b>Charging</b>	2 contacts for cradle charging
<b>Power</b>	On/off button
<b>Registration</b>	Push button for registration with Access Link
<b>Dimensions (L x W x H)</b>	6.0" x 1.1" x 1.1" (153 x 28 x 28mm)
<b>Weight</b>	2.6 oz (73g)

## MEDIA CONNECTOR

<b>Description</b>	Wireless audio transceiver
<b>USB power</b>	5V USB-C connector
<b>Wireless communication</b>	Access Technology (1.9 GHz)
<b>Tone control</b>	1 bass/treble control
<b>Audio input</b>	Four (4) 3.5mm inputs
<b>Audio output</b>	Two (2) 3.5mm outputs
<b>Audio Link indicator</b>	1 LED on front panel
<b>Device registration</b>	Push button for Access Link
<b>Dimensions (W x H x D)</b>	7.6" x 5" x 1.13" (193 x 127 x 29mm)
<b>Weight</b>	9.6 oz. (272g)



## Dedicated to Access for All

We strive to make a remarkable difference for teachers and students by creating Access to powerful in-the-moment insights to the learning process. Our audio and video solutions improve student engagement, enable teachers to activate small groups, and encourage collaboration.

11509 SW Herman Road  
Tualatin, Oregon 97062  
Toll Free: 800.732.8999  
Phone: 503.684.5538  
Fax: 503.684.3197  
[lightspeed-tek.com](http://lightspeed-tek.com)

