



USER MANUAL



Applied Acoustics Systems

Information in this manual is subject to change without notice and does not represent a commitment on the part of Applied Acoustics Systems DVM Inc. The software described in this manual is furnished under a license agreement. The software may be used only in accordance of the terms of this license agreement. It is against the law to copy this software on any medium except as specifically allowed in the license agreement. No part of this manual may be copied, photocopied, reproduced, translated, distributed or converted to any electronic or machine-readable form in whole or in part without prior written approval of Applied Acoustics Systems DVM Inc.

Copyright ©2015 Applied Acoustics Systems DVM Inc. All rights reserved. Printed in Canada.

Program Copyright ©2008-2015 Applied Acoustics Systems, Inc. All right reserved.

Strum GS is a Trademark of Applied Acoustics Systems DVM Inc. Windows and Windows Vista are registered trademarks of Microsoft Corporation in the United States and other countries. Mac OS and Audio Units are registered trademarks of Apple Corporation. VST Instruments and ASIO are trademarks of Steinberg Soft Und Hardware GmbH. RTAS and AAX are registered trademarks of Avid Technology Inc. All other product and company names are either trademarks or registered trademarks of their respective owner. Unauthorized copying, renting or lending of the software is strictly prohibited.

Visit Applied Acoustics Systems DVM Inc. on the World Wide Web at

www.applied-acoustics.com

Contents

1	Introduction	7
1.1	System Requirements	7
1.2	Installation and Authorization	8
1.3	Getting Started	9
1.3.1	Using <i>Strum GS</i> in Standalone Mode	9
1.3.2	Exploring the Factory Sounds	9
1.3.3	Using <i>Strum GS</i> as a Plug-in	10
1.4	Getting Help	10
1.5	About this Manual	10
2	An Overview of <i>Strum GS</i>	11
2.1	Playing Mode	11
2.2	Chord Detection and Voicing	11
2.3	Strumming	12
2.4	Signal Flow	12
2.5	Interface	14
2.5.1	The Play View	14
2.5.2	The Edit View	15
2.5.3	The Effects View	16
3	Playing Strum GS-2	18
3.1	Keyboard Mode	18
3.1.1	Hammer-On and Pull-Off	18
3.2	Guitar Mode	18
3.2.1	Chord Keys	19
3.2.2	Strumming Keys	19
3.2.3	Guitar Mode with Auto-Strum	22
3.2.4	Chord Change	23
3.3	Loop Mode	24
3.3.1	Adding Expressivity to Loops	25
3.3.2	Creating MIDI Loops	25

3.3.3	Organisation of MIDI Loops on disk	26
3.4	Chord Voicing	26
3.5	Specific Techniques	28
3.5.1	Arpeggios	28
3.5.2	Trills	29
3.5.3	Muted Strum	29
3.5.4	Partial Strumming	29
3.5.5	Bass & Chords	30
3.5.6	Stationary Bend	30
4	Bank and Program Management	32
4.1	Banks and Programs	32
4.2	Saving Programs	32
4.3	The Bank Manager	32
4.4	Using MIDI Bank and Program Changes	34
4.5	Backups of Banks and Programs	34
4.6	Exchanging Banks and Programs	34
4.7	Restoring the Factory Library	35
5	Parameters	36
5.1	General Functioning of the Interface	36
5.1.1	Knobs	36
5.1.2	Switches	36
5.1.3	Drop-down Menus	36
5.1.4	Modulation Signals	36
5.1.5	Synchronisation	37
5.2	The Play View	37
5.2.1	The Play Mode	38
5.2.2	Pitch and Modulation Wheel	38
5.2.3	The Pickups Module	38
5.2.4	The Clock Module	39
5.2.5	Strumming	39
5.2.6	Chord Display	39

5.2.7	Chord Voicing	40
5.2.8	Loops Module	40
5.2.9	Keyboard	41
5.3	The Edit View	42
5.3.1	The String Module	42
5.3.2	The Pick Module	43
5.3.3	The Hammer-On module	45
5.3.4	The Mute Module	45
5.3.5	The Palm Module	46
5.3.6	The Body Module	46
5.3.7	The Pickups Module	47
5.4	The Effects View	47
5.4.1	EQ	48
5.4.2	Compressor	49
5.4.3	Amplifier	51
5.4.4	Delay	52
5.4.5	Distortion	53
5.4.6	Chorus	53
5.4.7	Flanger	55
5.4.8	Phaser	57
5.4.9	Wah	59
5.4.10	Notch Filter	59
5.4.11	Reverb	60
6	Utility Section	63
6.1	The MIDI LED and MIDI configuration	63
6.2	Tuning	64
6.3	History and Compare	64
6.4	Volume	64
6.5	Level Meter	64
6.6	The About Box	65

7	Audio and MIDI Settings	66
7.1	Audio Configuration	66
7.1.1	Selecting an Audio Device	66
7.1.2	Latency	66
7.2	MIDI Configuration	67
7.2.1	Selecting a MIDI Device	67
7.2.2	Creating MIDI Links	67
7.2.3	Creating a default MIDI Map	67
7.2.4	MIDI Program Changes	68
7.2.5	MIDI Bank Changes	68
7.2.6	Pitch bend	68
7.2.7	Aftertouch	68
7.2.8	Live MIDI Loop Control	69
7.2.9	Modulation wheel	69
8	Using <i>Strum GS</i> as a Plug-In	70
8.1	Audio and MIDI Configuration	70
8.2	Automation	70
8.3	Multiple Instances	70
8.4	Saving Projects	70
8.5	Performance	70
9	Appendix - Lists of Chords Detected by <i>Strum GS</i>	71
10	License Agreement	78

1 Introduction

Strum GS is a synthesizer dedicated to the emulation of acoustic and electric guitars. The synthesizer is entirely based on the AAS physical modeling technology and uses no sampling nor wave tables. Instead it produces sound by solving, on the fly, mathematical equations modeling the different components of a guitar and how they interact. This elaborate synthesis engine responds dynamically to the control signals it receives while you play thereby reproducing the richness and responsiveness of real instruments.

Strum GS features elaborate modeling of the vibrations of the strings, pick or finger action, the body of the guitar, pickups, a two-channel amplifier, speaker cabinet, spring reverb and various effects. *Strum GS* also includes many functionalities which make it easy to reproduce the playing techniques of a guitarist on a keyboard. *Strum GS* includes a chord detection module and performs automatic voicing of chords. In other words, you play the chords you know on the keyboard and *Strum GS* will voice them automatically, for different musical styles, as a guitarist would have played them. The picking-hand technique of a guitarist is reproduced by an auto-strum function, special strumming keys or using standard MIDI loops.

Before discussing the synthesizer in more detail, we would like to take this opportunity to thank you for choosing an AAS product. We sincerely hope that this product will bring you inspiration, pleasure and fulfill your creative needs.

1.1 System Requirements

The following minimum computer configuration is necessary to run *Strum GS*:

Mac OS

- Mac OS X 10.7 or later
- Intel Core processor or later
- 512 MB of RAM
- 70 MB of free hard drive space
- 1024 x 768 screen resolution
- Built-in audio interface

Windows

- Windows 7 or later 32-bit/64-bit
- Intel Core or equivalent processor

- 512 MB of RAM
- 70 MB of free hard drive space
- 1024 x 768 screen resolution
- Windows-compatible audio interface
- Windows-compatible MIDI interface/keyboard

Keep in mind that the computational power required by *Strum GS* depends on the number of voices of polyphony and the sampling rate used. These computer configurations will enable you to play the factory sounds with a reasonable number of voices but performances will vary depending on your specific computer configuration.

1.2 Installation and Authorization

Installation and authorization of *Strum GS* is quick and easy. For the installation of our different products we use so-called *custom installers* which include both the program itself and your licence information. Installation and authorization can therefore be carried out automatically in a single step and from a single file when your computer is online. AAS products use a copy protection system based on a proprietary challenge/response key exchange and therefore their authorization does not rely on other third party software and/or hardware.

In order to start the installation process, simply double-click on the installer file that you have downloaded. This will first install the program and then use the licence information included in the custom installer file to carry out automatically the challenge/response procedure.

Once the installation is completed, you can check your licence information by starting the program and clicking on the chevron icon at the top of the interface. This will open a dialog box in which you should see your serial number and the email address which you used in order to get the installer file. Note that your serial number is also sent to you by email when your custom installer is created.

If your computer is offline when running the installer, or if the authorization procedure could not be completed for another reason, the dialog box will not show your serial number and you will be prompted to authorize the program. In that case, click on the *Authorize* button and follow the on-screen instructions. Note that it is possible to use the program during 15 days before completing the authorization process. After that period, the program will not function unless it is authorized.

1.3 Getting Started

1.3.1 Using *Strum GS* in Standalone Mode

Strum GS comes with a standalone versions allowing you to play it without having to open your sequencer. This can be convenient to explore *Strum GS* and its library, play it live or do some sound design work. To start *Strum GS* in standalone mode, simply follow the instructions below:

- **Windows** - Double-click on the *Strum GS* icon located on your desktop or select *Strum GS* from the **Start > All Programs >** menu.
- **Mac OS** - Double-click on the *Strum GS* icon located in the Applications folder.

Before you start exploring the program, take a moment to set up you audio and MIDI configuration as explained below.

Audio and MIDI Configuration

Audio and MIDI configuration tools are available by clicking on the **Audio Setup** button located in the lower left corner of the *Strum GS* interface. The **Audio Setup** dialog first allows you to select an audio output device from those available on your computer. Multi-channel interfaces will have their outputs listed as stereo pairs.

On Windows, the audio output list is organized by driver type. The device type is first selected from the *Audio Device Type* drop-down list. If you have ASIO drivers available, these should be selected for optimum performance. The **Configure Audio Device button** allows you to open the manufacturer's setup program for your audio interface when available.

Once the audio input has been selected, you can then select a sampling rate and a buffer size from those offered by your audio interface.

The list of available MIDI inputs appears at the bottom of the dialog. Click on the checkbox corresponding to any of the inputs you wish to use.

1.3.2 Exploring the Factory Sounds

Strum GS comes with a wide range of factory programs right out of the box which amounts to a huge range of sounds before you have even turned a single knob. As you would expect, the best way of coming to grips with the possibilities *Strum GS* offers is simply to go through the programs one at a time.

Strum GS uses the notions of *Banks* and *Programs* to organize and classify sounds. A program or preset is a stored set of parameters corresponding to a given sound. The programs are grouped and organized in banks.

The name of the currently loaded bank and program are displayed at the top of the interface. One navigates among the different banks and programs by using the arrows in each of the corresponding boxes or by opening the associated drop-down menu by clicking inside these boxes. Banks and programs are managed using the *Bank Manager* which is revealed by clicking on the *Manage* button appearing above the right-top corner of the *Bank* box. Playing programs and organizing them is pretty straightforward, please refer to Chapter 4 for a complete description of the bank and program management operations.

1.3.3 Using *Strum GS* as a Plug-in

Strum GS integrates seamlessly into the industry's most popular multi-track recording and sequencing environments as a virtual instrument plug-in. *Strum GS* works as any other plug-in in these environments so we recommend that you refer to your sequencer documentation in case you have problems running *Strum GS* as a plug-in. Note that in plug-in mode the audio and MIDI inputs, sampling rate, and buffer size are determined by the host sequencer.

1.4 Getting Help

AAS technical support representatives are on hand from Monday to Friday, 9am to 6pm EST. Whether you have a question on *Strum GS*, or need a hand getting it up and running as a plug-in in your favorite sequencer, we are here to help. Contact us by phone or email at:

- North America Toll Free: 1-888-441-8277
- Worldwide: 1-514-871-8100
- Email: support@applied-acoustics.com

Our online support pages contain downloads of the most recent product updates, and answers to frequently asked questions on all AAS products. The support pages are located at:

1.5 About this Manual

Throughout this manual, the following conventions are used:

- Bold characters are used to name modules, commands and menu names.
- Italic characters are used to name controls on the interface.
- Windows and Mac OS keyboard shortcuts are written as Windows shortcut/Mac OS shortcut.

2 An Overview of *Strum GS*

Strum GS is a synthesizer which was designed with the goal of enabling keyboard players to easily create realistic guitar tracks. This is a task which is usually difficult to achieve due to the very different nature of these two types of instruments. *Strum GS* was therefore designed to reproduce not only the sounding mechanisms of a guitar but also the main elements of the playing technique of a guitar player.

Very generally playing on a guitar can be described in terms of fretting hand (usually left hand) and picking hand (usually right hand) techniques. The fretting hand is used to fix the chords or notes played on the different strings of the guitar while the picking hand is used to set the different strings into vibration and therefore play melodies or strumming patterns. In *Strum GS*, these functions have been integrated into a chord detection, voicing, and strumming module.

2.1 Playing Mode

In practice, *Strum GS* can be played using one of three available modes: *Keyboard*, *Guitar*, or *Loop* mode.

In *Keyboard* mode, *Strum GS* reproduces what is played on the keyboard as for any other keyboard instrument without trying to voice what is being played. The range of the instrument is then limited to the natural range of a guitar as the notes still need to be played on the modeled strings on which *Strum GS* is based.

In *Guitar* mode, *Strum GS* voices chords played with the fretting hand and reproduces picking hand technique using special strumming keys as described below.

Loop mode is similar to *Guitar* mode except that strumming and picking patterns are played from recorded MIDI files.

2.2 Chord Detection and Voicing

Chords played on a keyboard and a guitar share the same name but are played or voiced differently. Because of the tuning of the strings on a guitar, the notes of the chord are not usually played in the same order as on a keyboard and the range of the notes is usually different, notes may also be repeated. Furthermore, the same chords can be played in different positions on the guitar depending on the playing or musical style. This specific way of playing chords on a guitar is very characteristic of the tone and sound of the instrument. It is therefore very important, in order to obtain a realistic guitar sound, to play chords as a guitar player would rather than how they are played on the keyboard.

In *Guitar* or *Loop* mode, the voicing of chords is performed in two steps by *Strum GS*. A chord played on the keyboard is first interpreted by the chord detection module in order to determine which chord was played on the keyboard. *Strum GS* then finds a guitar voicing corresponding to

this chord. In other words, *Strum GS* finds how a guitar player would have played this particular chord.

When chords are played on the keyboard, the order of the notes above the root is not taken into account by the chord detection engine. This implies that you can play the chords as you know them on the keyboard without having to know or learn special voicings used by guitar players. For example, you could play chords in close position with the left or right hand, you could also play the root with the left hand and the rest of the chord with the right hand or play the chords with the notes spread across both hands. *Strum GS* will take care of finding the right voicing and playing position on the guitar depending on the settings of the chord type and playing position controls as described in section 3.4

The name of the chord detected as well as the specific voicing chosen by *Strum GS* is displayed in the fretboard located in the lower portion of the graphical interface of the *Play* view. Note that the voicing chosen by *Strum GS* varies depending on the chord type chosen by the user as is described in Section 3.4. *Strum GS* will try to detect a chord as soon as three or more keys are depressed on the keyboard. Please refer to section 9 for a list of the chords detected by *Strum GS*.

2.3 Strumming

On a guitar, notes and chords are triggered by the action of the picking hand (usually right hand). The resulting sound is very typical of a guitar as the guitarist triggers the strings sequentially, more or less rapidly, with an up and down motion of the hand. Strings can also be played individually, in different order, to create arpeggio patterns. Different sonorities can be obtained by damping or muting the strings either by applying the picking hand on the strings near the bridge (palm muting) or releasing the pressure on the notes played with the fretting hand (scratching) while strumming. Using these different types of hand motions and techniques, the guitarist can create complex melodic and rhythmic patterns. In *Strum GS*, these different effects can be achieved through a strumming module which is controlled by special strumming keys or MIDI loops as will be explained in more details in Chapter 3 and 5.

2.4 Signal Flow

The general signal flow of *Strum GS* is presented in Figure 1 and illustrates schematically how the different modules in *Strum GS* interact. From left to right, the synthesizer first includes a chord detection module which parses the MIDI signal it receives and determines the chords played on the keyboard. This information is then sent to the voicing engine which, taking into account how a guitarist would actually play the different chords, determines which notes are played on the different strings of the guitar. The corresponding information, for each of the six strings of the instrument, is then sent to a triggering or strumming module which generates an excitation signal for each of the individual string. This is the signal received by the synthesis or string module which then simulates the vibration signal of the individual strings of the guitar. The output of this module corresponds to the signal that would actually be measured at the bridge of the instrument

and which is transmitted to the body of the instrument. The body module completes the instruments and simulates how sound is radiated both from the top-plate of the body (or soundboard) and the air cavity of the body. Finally, in addition to the modules reproducing the guitar itself, a multi-effect processor has been included to allow further shaping of the sound radiated by the instrument. The multi-effect processor comprises an equalizer, a compressor, two effects, and a reverb.

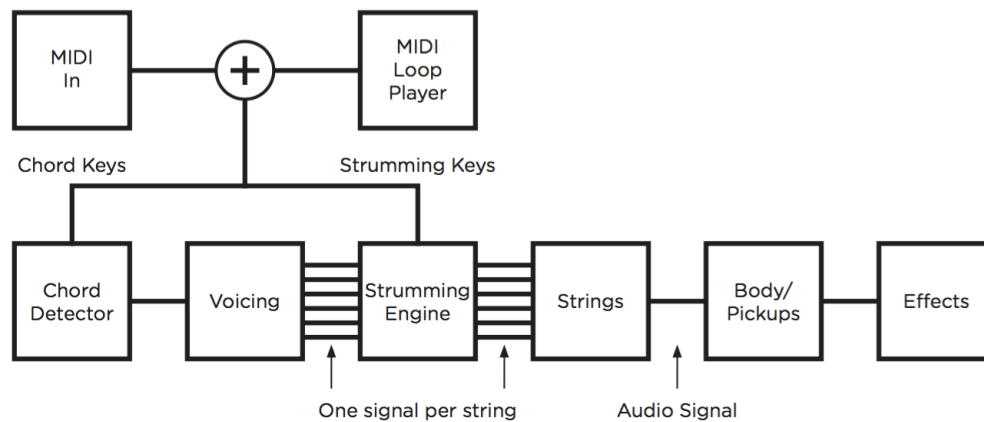

Figure 1: General signal flow of *Strum GS*.

It is important to note how the MIDI signal received by the synthesizer is parsed. In *Guitar* and *Loop* mode, signal received from the MIDI input or MIDI player module, is interpreted in terms of the fretting hand (usually left hand) and picking hand (usually right hand) of a guitar player. MIDI notes with number ranging between E two octaves below middle C (MIDI note number 40) and C one octave above middle C (MIDI note number 72) are associated with the fretting hand and their corresponding signal is sent to the chord detector. Notes in the octave just above (MIDI note number ranging between 72 and 84) are special strumming keys, used to trigger different picking hand techniques, and are therefore used to control the strumming engine. The use of these strumming keys is explained in more details in section 3.2.2.

In the case of the electric guitar, in addition to the instrument itself, the amplifier and cabinet are fundamental to the production of sound. A two-channel amp, with cabinet and spring reverb has therefore been added to the signal flow between the two effects of the multi-effect processor as show in Figure 2.



Figure 2: Position of the amplifier in the signal chain in the case of the electric guitar.

2.5 Interface

The graphical user interface has been organized around three different views as shown in Figures 3, 4, 5, 6, and 7.

The first view, called the *Play* view of the instrument, is the main view and gives access to different performance parameters of the guitar. The second and third views, called the *Edit* and *Effects* views respectively, are used for in-depth editing of the synthesis and effect parameters.

One can switch from one view to the other by using the *Play*, *Edit* and *Effects* buttons located in the *Utility* section at the top of the interface. This section of the interface is common to all the views and includes the bank manager, used to access and manage sounds, as well as general settings and indicators. These tools are described in details in Chapter 4 and Chapter 6 respectively.

The interface for acoustic and electric guitars is different and changed accordingly when selecting an acoustic or electric guitar preset. While the interface changes when switching from one type of guitar to the other, the general functioning is similar regardless of the type of guitar used. The main differences appear in the *Play* and *Edit* view. In the *Play* view the EQ and compressor modules appearing with acoustic guitars is replaced by an amplifier module in the case of the electric guitar while in the the *Edit* view, the body of the acoustic guitar is replaced by a pick-up in the case of the electric guitar.

The size of the graphical interface can be adjusted by click-dragging the handle in its lower right corner. While resizing the interface the zoom factor is displayed in the upper left corner of the interface. This zoom factor can always be displayed by positioning the mouse on this corner. When clicking on the zoom factor, a drop-down menu with specific size ratios is displayed. Selecting a value resizes the interface automatically to that ratio. Note that this resize feature is only available for 64-bit versions of the program.

2.5.1 The Play View

The lower section of this view includes a playing mode selector, a master clock, a chord display, a loop player as well as as modules controlling strumming and voicing and vibrato which will be described in more details in Chapter 5.

On the left of these parameters, one finds a pitch bend wheel and a modulation wheel. The modulation wheel is normally used to control the amount of vibrato in the sound but it can also be used to adjust any other parameter through MIDI links which will be described in Chapter 7. Just below is a clickable five octave keyboard giving information on the keyboard layout specific to each playing mode and allowing one to play different notes which can be useful when no MIDI keyboard is connected to the computer.

The middle section of this view allows one to turn the effects from the multi-effects module, compression and equalizer *on* and *off* and to rapidly adjust their main parameters.



Figure 3: The Play view for acoustic guitars.



Figure 4: The Play view for electric guitars.

2.5.2 The Edit View

The *Edit* view gives access to the synthesis parameters described in details in Chapter 5 and allows one to really go under the hood. In particular pick, individual strings and body parameters can all be adjusted allowing one to really customize the presets and even create new instruments.



Figure 5: The Edit view.



Figure 6: The Edit view for electric guitars.

2.5.3 The Effects View

The *Effects* view includes an equalizer, a compressor, a multi-effects, and a reverb module. The multi-effects module consists in two effects in series. The effect list includes a delay, distortion, chorus, flanger, phaser, wah wah, auto wah and a notch filter. The functioning of the effect modules is described in details in Chapter 5.



Figure 7: The FX view.

3 Playing Strum GS-2

Strum GS can be played in three different modes: *Keyboard*, *Guitar*, or *Loop* mode. The playing mode is selected by clicking on the corresponding button in the *Play Mode* box in the lower left part of the *Play* view of the interface. In this chapter, we review how these different modes work and describe the special keyboard layout each of them uses. We also review the different options that affect chord voicing in *Guitar* and *Loop* mode and discuss how to obtain specific guitar techniques.

3.1 Keyboard Mode

The *Keyboard* mode is the simplest way to play *Strum GS*. In this configuration, *Strum GS* basically plays notes on the guitar as they are played on the keyboard. In other words, *Strum GS* does not attempt to voice notes or chords played on the keyboard. The main difference with a traditional keyboard instrument is the range of the instrument. *Strum GS* indeed needs to play the notes on the different strings of the modeled guitar so will only react to notes in the normal range of the guitar that is from the second E below middle C (MIDI note number 40) to the third A above middle C (MIDI note number 93).

The *Keyboard* mode is the only one that allows one to play melodies and intervals, it is therefore used for lead guitar playing. It also enables one to play chords without voicing from *Strum GS* and therefore to control exactly how they are played.

3.1.1 Hammer-On and Pull-Off

In *Keyboard* mode, hammer-ons and pull-offs are automatically triggered by playing legato notes spaced by one or two semi-tones. Hammer-on and pull-off are playing techniques used by guitar players to play legato or grace notes. The hammer-on effect is obtained by first picking a note and then hammering down another finger onto the same string at a higher fret. The pull-off effect is almost the opposite of the hammer on. It is obtained by first picking a note and then sharply pulling-off the finger from the fretboard in order to hear a second fretted note on the same string. The sounds produced using these techniques are softer and less percussive than the ones produced by picking the notes.

3.2 Guitar Mode

In this mode, the MIDI signal received by *Strum GS* is interpreted in terms of the fretting hand (usually left hand) and picking hand (usually right hand) of a guitar player. The range of the MIDI keyboard has therefore been divided into two sections, the *Chord keys* section and the *Strumming Keys* section as illustrated in Figure 8.



Figure 8: Sections of the MIDI keyboard as used by *Strum GS* in *Guitar* mode. The C with the dot is middle C

3.2.1 Chord Keys

This section is associated with the fretting hand of the guitarist and includes notes ranging from the second E below middle C (MIDI note number 40) to B one octaves above middle C (MIDI note number 71). This section of the keyboard is where chords are played and it is the MIDI signal from this section which is sent to the chord detection and voicing modules as explained in section 2.4. *Strum GS* will try to detect a chord and find a corresponding voicing as soon as three or more key are depressed on the keyboard. Note that the exact guitar voicing chosen by *Strum GS* depends on the setting of the Voicing module as will be explained in section 3.4.

Automatic Chords

In *Guitar* mode, chords are always played by *Strum GS* when a single note or special configuration of two or three notes are played in the *Chord Keys* section of the keyboard making it very easy to create strumming patterns. When only a single note is played, a major chord is automatically constructed using this note as the chord root. A minor chord is created by playing a root note and the first black key to its left. A seventh chord is played by depressing a root note and the first white key to its left. A minor seventh chord is obtained by playing a root note and the first black and white key to its left. These special rules are illustrated in Figure 9 with the key of C as an example. Note that other two note intervals are ignored and a major chord is played using the first note of the interval which was played as the root of the chord.

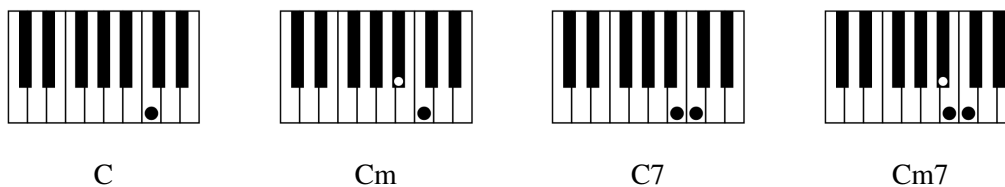

Figure 9: Automatic chords. The key of C is used as an example but all keys follow the same rules.

3.2.2 Strumming Keys

The twelve notes from the C note located one octave above middle C (MIDI note numbers 72 to 83) are interpreted as special strumming keys and are used to trigger different picking hand techniques.

Note that these special strumming keys appear in a mirror configuration starting on C located three octaves below middle C allowing one to trigger them with the left hand instead of the right hand. Depending on the strumming keys used one can trigger downstrokes, upstrokes as well as muffled downstrokes and upstrokes and palm muted downstrokes. Strings can also be triggered individually to play arpeggio patterns. The effect of the different strumming keys, illustrated in Figure 10, is now reviewed.

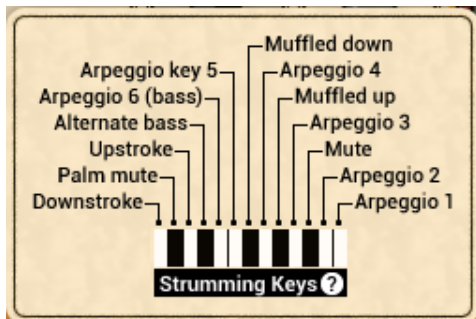

Figure 10: Strumming keys as used by *Strum GS* in *Guitar* mode.

Downstroke and Upstroke

A downstroke is achieved by dragging a pick (or the fingers) across the strings of the guitar in a downward motion. Notes are therefore played from lowest to highest. An upstroke is obtained in the same manner but dragging the pick or fingers upwards from the highest to the lowest string. A downstroke is triggered by depressing C while an upstroke is triggered by depressing D one octave above middle C (MIDI note 72 and 74). These strokes represent the simplest way to play chords on a guitar and can be played alternately. Note that when strings are not used in a specific voicing (strings with no dot on the chord display), they are not played when using a downstroke or an upstroke. If no note is played on the keyboard, the downstroke and upstroke keys trigger a strum but the strings are muted. The effect is the same as using the muffled down- and upstroke keys which are described below



Figure 11: Downstroke and upstroke on a C chord with the strumming keys.

Palm Muting

Palm muting is a technique which consists in partially muting the strings with the help of the picking hand by letting it lightly touch the strings near the bridge. The pick (or fingers) is then dragged across the strings in a downward or upward motion. In *Strum GS*, the palm muted downstroke is obtained by depressing C# one octaves above middle C (MIDI note number 73).



Figure 12: Alternating downstroke and palm muting.

Muffled Downstroke and Upstroke

On a guitar, fretted notes can be muted by decreasing the pressure applied by the fretting fingers on the strings. The guitarist can control the effect by applying more or less pressure on the strings and obtain a percussive effect by striking the strings with the picking hand. This effect is also known as scratching. In *Strum GS*, the muffled downstroke and upstroke are obtained by depressing F# and G# one octave above middle C (MIDI note number 78 and 80) respectively. Using these keys has the same effect as using the down- and upstroke keys without playing a chord on the keyboard, but these strumming keys allow one to obtain the effect without releasing the chord.



Figure 13: Scratching with the strumming keys.

Mute All

A muted strum is a stroke which is immediately muted by applying the full hand on all the strings in order to completely stop the sound. In *Strum GS*, this effect is reproduced by depressing Bb

one octave above middle C (MIDI note number 82).

Playing Individual Strings

The strings of the guitar can be played individually enabling one to arpeggiate or create finger picking patterns. Individual strings are triggered by depressing notes corresponding to white keys between E one octave middle C and C two octaves above middle C (MIDI notes 76, 77, 79, 81, 83 and 84, arpeggio keys 6 to 1).

In chords using the six guitar strings, these arpeggio keys (number 6 to 1) correspond to the individual strings from string 6 (lowest E) to string 1 (highest E). When some voicings use less than six strings, the arpeggio keys corresponding to the unused strings repeat the note of the following or preceding string depending if it is the lowest or highest note of the chord. For example for a chord using strings 5 to 1, the lowest note on string 5 will be repeated on the arpeggio key 6 (E). For a chord using strings 6 to 2, the highest note of the chord from string 2 will be repeated on the arpeggio key 1 (second C in the strumming key section). Exceptionally for chords played on four strings, string 4 will be repeated on the arpeggio keys 6 and 5 (E and F), string 1 will be repeated on the arpeggio keys 2 and 1 (B and C) while strings 2 and 3 will be moved to the arpeggio keys 3 and 4 (G and A). Indeed, this configuration ensures that the lowest note of the chord will appear on arpeggio key 6 and that arpeggio keys 4, 3, and 2 will always play a different note which is convenient to play an arpeggio patten in any chord voicing type.

Alternate Bass

In certain musical styles, such as country and bluegrass, one often finds rhythm-guitar patterns obtained by switching the root or fifth played on the bass string and a strum on the remaining strings. To easily recreate these effects, *Strum GS* maps the fifth or alternate bass on the E \flat key (MIDI note number 75) located one octave above middle C. When there is no fifth in the chord, the root of the chord is instead mapped to this key.

3.2.3 Guitar Mode with Auto-Strum

When the *Auto-Strum* mode is selected, strumming is triggered as notes or chords are played on the keyboard without having to use the strumming keys. This mode is switched *on* or *off* by clicking on the *Auto* button in the *Strumming* section of the interface. In *Auto-Strum* mode, chord are strummed using a downstroke or in other words, notes are played from lowest to highest.

When the *Auto-Strum* mode is switched *off*, notes and chords are processed by the chord detection and voicing modules but the strings are not triggered. In order to play them, one must use the different strumming keys as described in section 3.2.2. As soon as a strumming key is depressed, the strings are triggered. Note that strumming keys are always active whether the *Auto-Strum* mode is switched *on* or *off*.

Strum Down

Play a chord in the *Chord Keys* section of the keyboard as shown in Figure 14. The chord is detected by *Strum GS* and voiced on the guitar fretboard. This triggers a downstroke from the strumming module and consequently the strings are played from the lowest to the highest. In order to trigger a new downstroke without muting the strings, just release one note from the chord and play it again as shown in Figure 15.



Figure 14: A simple strumming sequence.

3.2.4 Chord Change



Figure 15: Re-triggering a downstroke.

Once a chord has been played, the chord detection, voicing and strumming modules are only triggered when a new note or a strumming key is played; releasing notes from a chord has no effect. Consequently, *Strum GS* holds the current chord as long as all its notes are not released. This can be used to make rapid chord changes. For example, it is possible to switch from a C chord to a G chord without muting the strings by playing C-E-G and then by replacing C and E by B and D without releasing the G as shown in Figure 16. The same effect can be obtained with chords which do not share common notes by using the sustain pedal.



Figure 16: Smooth chord transition.

On the other hand, if one wishes to remove a note from a chord, for example to switch from a C7 chord (C-E-G-B \flat) to a C chord (C-E-G), it is not sufficient to release the B \flat key. It is necessary, in order to trigger again the chord detection module, not only to release the B \flat from the chord but

also to depress a strumming key or to release another note from the chord, for example the G, and replay it when one wants to strum the new chord.

Chords and Change of Pitch

Playing chords on higher or lower notes on the keyboard does not affect where *Strum GS* plays them on the fretboard as it always tries to play chords on a position as low as possible. *Strum GS*, however, will take into account the fret position as set by the *Position* parameter of the **Voicing** module and play the chords on this fret or above whenever possible. The only exception to this is when drop chords are used in which case *Strum GS* will try to follow chord position as closely as possible.

3.3 Loop Mode

Reproducing complex strumming patterns can rapidly become complicated and requires to be a good keyboard player. The good news is, however, that *Strum GS* is supplied with a library of MIDI loops which you can use to easily start creating a new piece. A MIDI loop is a recording of strumming patterns created using the special strumming keys available in *Guitar* mode as described in section 3.2. These patterns are automatically applied to chords played on the keyboard.

In *Loop* mode, the MIDI keyboard is divided into a *Chord Keys* section where chords played by the fretting hands are played and a *Loop Keys* section, as illustrated in Figure 17, from which MIDI loops reproducing strumming key patterns are triggered. Note that the automatic voicing of chords in *Loop* mode is done in the same way as when playing in *Guitar* mode.

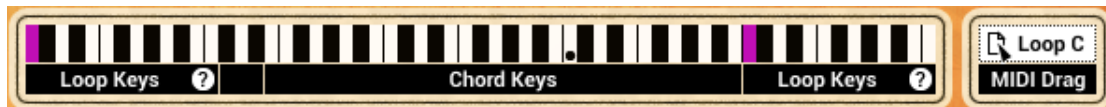

Figure 17: Sections of the MIDI keyboard as used by *Strum GS* in *Loop* mode. The C with the dot is middle C

Each *Strum GS* preset is saved with a set of seven loops called a *loop pack*. The seven white notes in the *Loops Keys* section of the keyboard, from C to B located one octave above middle C, are used to trigger one of the seven loops of a loop packs as shown in Figure 18. The same *Loop Keys* also appear in mirror configuration starting on the C key located 3 octaves below middle C. Loop packs can be loaded from the **Loops** module from the *Play* view as will be explained in section 5.2.8. The currently selected loop is indicated by the purple key in the *Loop Keys* section of the keyboard.

Once triggered, loops play until the notes held in the *Chord Keys* sections are released or if the B \flat or second C of the *Loop Keys* section is depressed. The difference between these two keys is that the B \flat , *Mute* key mutes all strings and the sound stops as soon as the key is depressed. When the C or *Stop* key is used, the loop stops but the sound is allowed to decay naturally.

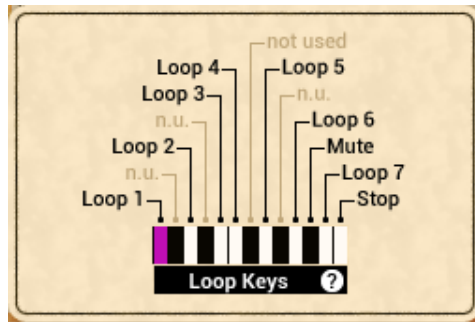

Figure 18: Strumming keys as used by *Strum GS* in *Loop* mode.

3.3.1 Adding Expressivity to Loops

In order to make MIDI loops more expressive, *Strum GS* allows one to link two different MIDI controllers to some performance parameters such as playing softer or louder, slower or faster, increase or decrease the strumming span and putting emphasis on lower or higher strings when strumming. To access this modulation matrix, open the MIDI configuration window by clicking on the **MIDI** button located just below the MIDI led in the top part of the interface and assign effects to controllers in the Live MIDI Loop Control section of the window.

3.3.2 Creating MIDI Loops

Loops for *Strum GS* are easily created in your favorite sequencer by respecting the following rules:

- All the events must be on MIDI channel 1.
- The loop must begin at the start of the file and finish at the end of the track. In other words, if the track lasts for four bars but there are notes only in the first bar, *Strum GS* will still loop over the four bars.
- The tempo and the time signature must be defined at the beginning of the loop and must not change during the rest of the loop. *Strum GS* indeed ignores tempo changes occurring in the middle of a loop.
- The loop must be recorded on disk on a file using MIDI format 0 or 1 and having a .mid extension.

Here are other advices which help to create more realistic loops:

- Always slightly vary the velocity of strumming keys in order to get a more lively result.
- If the loop is short, it may be preferable to repeat the same patterns many time with different velocities for each repetition.

- If the loop includes chords, always make sure that they are well quantized and that there is always a strumming key played at the same time. This will avoid unwanted strokes when the loop is played while the *Auto-Strum* mode is switched *on*.
- Avoid using MIDI controllers whose effect can be changed by the user. For example, the pitch wheel can either be used to create a bend or a slide; the hold pedal can either hold the current chord or be used to trigger an alternate strum.

3.3.3 Organisation of MIDI Loops on disk

Loops are stored at a specific location on disk:

On **Mac OS**:

/Library/Application Support/Applied Acoustics Systems/Strum GS-2/MIDI Library

On **Windows**:

%PROGRAMFILES(X86)%\Applied Acoustics Systems\Strum GS-2\MIDI Library

Clicking on the *Show Files* button on the *Loops* module of the *Play* view opens a Finder or Explorer window (on Mac OS X or Windows respectively) at this specific location. Loops are organised into banks whose name correspond to folder names within the loops folder. These names are those appearing in the *Bank* drop-down menu in the *Loops* module and Loop packs under these categories are stored within these folders. The seven loops in a pack all share the same name except for the letter associated with the note (letters A to B) used to trigger a specific loop which is appended to the loop name.

3.4 Chord Voicing

On the guitar, there are usually many different ways to play the same chord. Each of these positions or voicing sounds differently and suits different musical styles. The specific voicing chosen by *Strum GS* for a chord depends on the *Type* parameter from the *Chord* section of the interface. One can choose between four types of chords:

- **Open Chords.** These are chords played with a combination of fretted notes and open strings. These chords are usually played only within the first three frets of the fretboard. Open chords are easy to play and extensively used when playing folk music. Note that all chords do not necessarily have an open position on the guitar.
- **Movable Chords.** These chords do not use open strings. As a result they can be moved along the fretboard of the guitar allowing one to easily play the same voicing in different tonalities. This type of chords includes barre chords which are obtained by using one finger to press down multiple strings across the fretboard. Movable chords always use the maximum possible number of strings and are therefore useful to play arpeggios. Furthermore they allow one to play the same arpeggio patterns in different keys.

- **Drop Chords.** These are four note chords which allow for fast and subtle movement between chords. The positions used by *Strum GS* are based on drop 2 and drop 3 chords. These chords are obtained by dropping the second or third voice of a chord down one octave. This type of chord sounds lighter and is extensively used in jazz.
- **Powerchords** A power chord, also known as fifth chord, consists in a note and another one a fifth above. In other words it is like a triad without the third. Powerchords are extensively used in rock music especially with highly distorted sounds as including the third usually results in unpleasant frequency components in the distorted sound. They are also easy to play. In powerchord mode, any chord played on the keyboard which contains a natural fifth will be played with 3 notes: the root, the fifth and the octave. If the chord is inverted on its fifth, the power chord played by *Strum* is also inverted and the notes played in the following order: fifth, root and octave. Note that it is also always possible to play powerchords with the other chord types by playing a fifth, root and fifth's octave.

In addition to these voicing categories, the voicing can be made more precise by specifying what should be the lowest note of the chord played by *Strum GS*:

- **Lowest.** The lowest note in the guitar voicing chosen by *Strum GS* is the lowest note played on the keyboard. This type of voicing is useful if it is necessary that the bass of the chord sequence follows a specific movement. Note that for open and movable chords many inversions do not have an interesting voicing on the guitar and in this case, the four note voicing generated by *Strum GS* may sound a bit out of place in a chord progression.
- **Root.** The lowest note in the guitar voicing chosen by *Strum GS* is the root of the detected chord. It is very common for guitar chords to have the root in bass position. This choice of chord type allows one to play chords on the keyboard using any voicing and still obtain a guitar chord in root position.

The *Playing Position* parameter from the *Chord* section allows one to specify the lowest fret on which the lowest note of a chord should be played. This control gives *Strum GS* an indication of the position on the neck where chords should be played and chords are voiced accordingly when possible. This parameter is of course only valid for movable chords and it is therefore inactive when open chords are chosen.

Note that in all chord voicing one finds a fifth even if it was not played on the keyboard which in practice corresponds to what guitar player do. The only exception is for drop chords where only notes played on the keyboard are used in the voicing and therefore may not contain a fifth.

Although there is no general rule and there are many ways to play in different musical styles or obtain different effects, we give some guidelines on chord types and performance settings which should work well in specific situations:

- **Folk.** Open-Root and medium strumming speed.

- **Country and Bluegrass.** Open-Root with a high strumming speed.
- **Pop-Rock.** Movable-Root.
- **Arpeggios with bass motion.** Movable-Lowest or Open-Lowest.
- **Jazz.** Drop chords.
- **Samba Bossa.** Drop chords. Use the arp 6 strumming key to play the bass and arp keys 4, 3 and 2 simultaneously to play the rest of the chord.
- **Funk.** Movable-Root with *Playing Position* on a high fret.
- **Flamenco** Open-Root with a rapid strumming speed. Use the alternate strum on the four highest strings.

3.5 Specific Techniques

We now look at ways to create more elaborate effects. For these examples, it is assumed that we are using the *Guitar* mode and that the *Auto-Strum* mode is switched *off* as we will now be using the strumming keys. This way of playing *Strum GS* involves to think more in terms of a guitar player and it is preferable to play the chords slightly before triggering the strumming action in order to avoid glitches when a strumming key is used before a chord is fully formed on the keyboard . This is just like a guitar player who needs to position the fretting hand on the fretboard before strumming with the picking hand.

3.5.1 Arpeggios

A chord can be arpeggiated using the arpeggio strumming keys (E, F, G, A, B and C). The effect of these keys depends on the chord played by *Strum GS* as explained in section 3.2.2. As many chords include only four strings (a bass and three high notes) it is common for the arpeggio 2 and arpeggio 1 keys to play the same note. Furthermore, depending on the position of the chord on the fretboard, the alternate bass key (arpeggio 5 key), can play a lower, higher or the same note as the bass key (arpeggio 6 key). The most useful arpeggio keys are therefore usually the arpeggio 6, 4, 3 and 2 keys (E, G, A and B). A good position to play arpeggios is to use the thumb to play the bass, the index to play the arp 4 key, the middle finger for the arp 3 key, the ring finger for the arp 2 key and finally the little finger for the arp 1 key. This position is similar to that of a guitar player.

Here is a simple example of an arpeggio. Play a C chord (C-E-G) with the left hand, and then use the right hand to trigger the Bass (E), arp 4 (G), arp 3 (A) and arp 2 (B) keys.

When playing arpeggios, it might be interesting to use *Movable-Lowest* chord types in order to obtain a motion of the bass. To try this, set the *Type* from the *Chord* section to *Movable-Lowest* and play the arpeggio from the preceding example using the following chord progression: C (C-E-G), CMaj7/B (B-C-E-G), C7/B \flat (B \flat -C-E-G) and Am7 (A-C-E-G).



Figure 19: A simple arpeggio.



Figure 20: Bass motion and arpeggios.

3.5.2 Trills

This technique consists in switching rapidly between two notes by using hammer-ons and pull-offs. Trills are available in *Keyboard* mode and are obtained by holding the first note and depressing and releasing the second note. The interval between the notes must be one or two semi-tones.

3.5.3 Muted Strum

A muted strum is a stroke which is muted immediately after having been played by applying the full hand on the strings. It is less dry than a scratch (muffled stroke) and brighter than a palm muted stroke. One way to recreate this effect is to strum a chord using the down- and upstroke keys (C or D) and playing the mute all key (B \flat) very rapidly.

3.5.4 Partial Strumming

A guitarist does not always strum all the strings in a chord and they also often vary the number of strings played between strumming strokes. To some extent, in *Guitar* mode, this is taken into account automatically by *Strum GS* using the MIDI velocity signal received from the keyboard. More control on this parameter, however, may be desired. One way to control exactly the number of strings that are strummed is to use the *Arpeggio* keys instead of the *Downstroke* and *Upstroke* keys. In other words, one strums a chord by depressing a certain number the *Arpeggio* keys together thereby controlling which strings are played in the chord. This can also be used to put emphasis

certain strings and also to introduce some variety and expression in the strumming. Another option is to alternate between this technique and the use of the downstroke and upstroke strumming keys.

Another technique which can be used to obtain partial strums consists in releasing strumming keys before the strum is completed. In this way, the strings still not strummed, are not played. In other words, partial strumming is achieved by playing staccato on the strumming keys while full strums are obtained by playing them normally. This technique is easier to perform when the strumming speed is relatively slow.

When using loops it is possible to vary in real-time the character of the strumming by mapping specific MIDI controllers to the strumming span and to the weight of low and high strings as explained in section 3.3.

3.5.5 Bass & Chords

In certain musical styles, such as country and bluegrass music, one often finds rhythm-guitar patterns obtained by switching between the root or fifth played on the bass string and a strum on the remaining strings. To obtain this effect, it is therefore important that the lowest string is note included in the stroked part of the pattern. In order to reproduce this effect with *Strum GS*, one must first use the bass or alternate bass key (E or E \flat) and hold it while playing one of the stroke triggers. Indeed, when *Strum GS* detects that a stroke key is played while the bass or alternate bass key is depressed, it removes this string from the strum.



Figure 21: Bass and Chord.

3.5.6 Stationary Bend

In this technique, the guitarists plays two notes simultaneously and bends one of the two notes. It is possible to obtain the effect with *Strum GS* by taking advantage of the fact that only the last note played is bent.

In *Keyboard* mode, one first plays the note which should not be bent and then the second one. The bending effect is then obtained by moving the pitch wheel or using the aftertouch. This

will only work, however, for intervals larger than one tone because otherwise *Strum GS* always automatically triggers a hammer-on or pull-off when intervals of one or two semi-tones are played legato.

In *Guitar* mode, the last string triggered with an arpeggio key can be bent either by using aftertouch or pitch wheel.

4 Bank and Program Management

Strum GS comes with several factory presets, called *programs*, covering a wide range of sounds. This collection of programs lets you play and familiarize yourself with this synthesizer without having to tweak a single knob. Soon, however, you will be experimenting and creating your own sounds and projects that you will need to archive or exchange with other users. In this section, we review the management of programs.

4.1 Banks and Programs

Sounds are stored in banks containing so-called *programs*. The name of the currently selected bank is shown in the *Bank* drop-down display located at the top of the *Strum GS* interface. The list of available banks is viewed by clicking on the *Bank* display. A bank can be selected by navigating in the list of banks using the left and right-pointing arrows in the display or by clicking on its name when the list of banks is open. Clicking on the bank display brings focus on this section of the interface, the display is then outlined by an orange line, and one can then navigate through the list of banks using the up, down, left, or right arrows of the computer keyboard.

The list of programs included in the currently selected bank can be viewed by clicking on the *Program* display located below the *Bank* display. A program is selected by using the left and right-pointing arrows or by clicking directly on its name. Once a program is selected, the value of the different parameters of the synthesizer are updated and it can then be played. As for the bank list, one can navigate through the program list using the computer arrows after clicking on the *Program* display.

4.2 Saving Programs

Programs are saved by clicking on the *Save* button located on the top of the *Program* display. When a program has just been loaded, this command is greyed and therefore inactive. It is activated as soon as a parameter of the interface is modified. Clicking on this command replaces the stored version of the program with the new one.

The **Save As** command is activated by clicking on the corresponding button which opens the **Save Program** pop-up window. It is then possible to save the program under a new name or its current one in any of the available program banks. Note that if the original name of the program is used, a new program with the same name will be created at the end of the program list meaning that the original program is not erased. This also implies that it is possible to have many programs with the same name in the same bank.

4.3 The Bank Manager

Banks and Programs can be edited using the **Bank Manager**. The manager window is displayed by clicking on the *Manager* button located above the *Bank* display. It is closed by clicking again

on the same button. On the left of the window, one finds the list of banks. Clicking on a bank name fills the list of programs located in the center of the window with the name of these included in the selected bank.

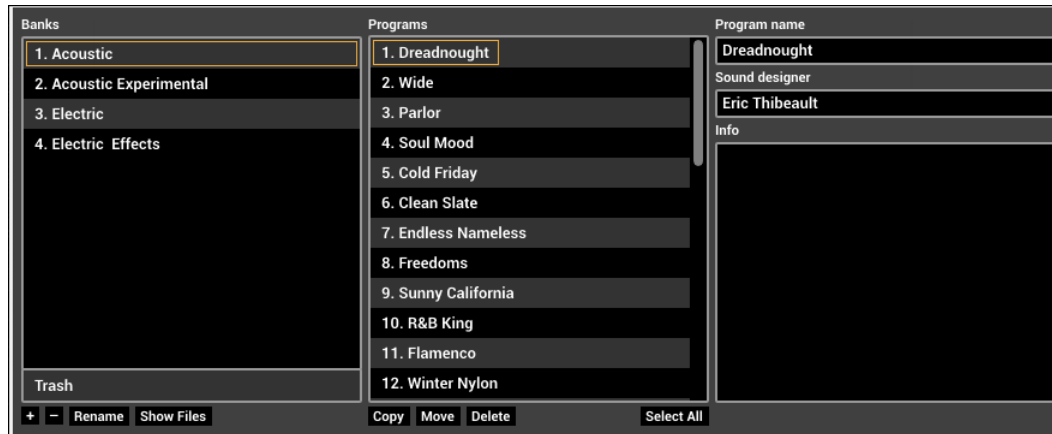

Figure 22: Bank and program manager window.

A new bank can be created by clicking on the + button below the bank list. This opens the **Create New Bank** window in which the name of the new bank can be entered. A bank can be deleted by first selecting it in the bank list and then clicking on the - button. Be careful, this command erases a bank and all the programs it contains; this operation is permanent and can not be undone. In order to rename a bank, simply click on the *Rename* button and enter a new name.

Banks and the information corresponding to each of its programs is stored in a simple text file on your computer hard disk. In order to view these bank files, click on the *Show Files* button under the bank list. On Windows, this command will open an Explorer window at the location where the files are stored. On Mac OSX, the command has a similar effect and opens a Finder window. All the bank file names follow the same format and begin with the bank name. These files can be used for backups or to exchange presets with other users.

The list of programs included in the selected bank is displayed in the program list in the center of the manager window. Presets are selected by clicking on their name which updates the program information appearing on the right of the preset list. Program information includes the name of the preset, its author and comments. This information can be updated by clicking on the corresponding box which opens an edition window. Note that multiple presets can be updated simultaneously by selecting more than one preset at once and clicking on a preset information box.

A multiple selection consisting of adjacent programs is obtained by holding down the *Shift* key on the computer keyboard and then clicking on the name of the first program to be copied and then the last one. A non-adjacent multiple selection is obtained by holding down the *Ctrl/command* computer key and clicking on the name of the different programs to be copied. It is also possible to select all programs at once by clicking on the *Select All* button at the bottom of the program list.

Programs can be copied to another bank by clicking on the *Copy* button. A program must first

be selected by clicking on its name on the program list; it is then copied by moving the mouse to a given bank in the *Bank* list on the right and clicking on the bank name. The **Move** command is activated by clicking on the *Move* button; it copies a preset to a new bank but also erases it in the original bank. A multiple selection of programs can be used with the **Copy** and **Move** commands

Programs can be deleted from a bank by first selecting them and then clicking on the *Delete* button. This will move the programs to a special bank called *Trash* which is located below the regular list of banks. This means that deleted programs can always be recuperated as long as they are not deleted from the *Trash* bank. The content of the *Trash* bank is viewed by clicking on its name; the different programs can then be moved to the other banks as explained above. The *Trash* bank can be emptied by clicking on the *Empty Trash* button which appears below the program list when the *Trash* bank is selected. Be careful as this command can not be undone.

4.4 Using MIDI Bank and Program Changes

Banks and programs can be changed using MIDI bank and program change commands. For more information on how to use these commands, please refer to sections 7.2.4 and 7.2.5.

4.5 Backups of Banks and Programs

User banks are stored on disk as simple text files located in the following folders:

On **Mac OS**:

/Users/[user name]/Library/Application Support/Applied Acoustics Systems/Strum GS-2/Banks

On **Windows**:

%AppData%\Applied Acoustics Systems\Strum GS-2\Banks

The bank files saved by *Strum GS* are named using the following convention:

[name of bank].GS-2 Bank

These files contain all the information corresponding to the programs they include. These files can be displayed directly from *Strum GS* by opening the *Bank* manager and clicking on the *Show Files* button. This will open an Explorer or Finder window on Windows or Mac OS respectively at the right location.

The simplest way to create a backup of banks and programs is to make a copy on an external media of the above mentioned folders. Individual banks can be backed-up by making copies of individual bank files.

4.6 Exchanging Banks and Programs

Banks and programs can easily be shared with other *Strum GS* users. This operation simply involves the exchange of the above mentioned user bank files. When a new bank file is copied to the bank folder, it is automatically available to *Strum GS*.

Note that individual programs can not be exported. They always appear inside a bank file. If you only wish to share a few programs, create a new bank, copy the programs you wish to exchange to this bank and share the corresponding bank file.

4.7 Restoring the Factory Library

If necessary, it is possible to restore the original factory library of banks and programs. The original factory bank files are located in the following folders:

On **Mac OS** startup disk:

/Library/Application Support/Applied Acoustics Systems/Strum GS-2/Factory Library

On **Windows 64-bit**:

C:\Program Files (x86)\Applied Acoustics Systems\Strum GS-2\Factory Library

On **Windows 32-bit**:

C:\Program Files\Applied Acoustics Systems\Strum GS-2\Factory Library

Restoring the factory library simply involves copying the files contained in these folders and pasting them in the user bank folders listed in Section 4.5. The user bank folders can be opened directly in an Explorer or Finder window, on Windows and Mac OS respectively, or by using the *Show Files* command directly from the *Strum GS* bank manager.

Note that if you have bank files with the original factory bank names in your user bank folder, they will be replaced by the original factory files. This means that you will lose programs that you would have modified or created in these banks. This operation must therefore be done with caution and it is recommended that you make copies or rename your user banks before proceeding with the restore.

5 Parameters

This section can be used as a reference for the different controls appearing on the *Strum GS* graphical interface. We begin by describing the behavior of the different types of controls appearing on the interface and then describe the parameters of each module of the synthesizer. Note that the interface of acoustic and electric guitar presets is different. All modules are shared between guitar types except for the **Body** module which only appears with an acoustic guitar preset is selected and the **Pickups** and **Amplifier** modules which appear with electric guitar presets.

5.1 General Functioning of the Interface

5.1.1 Knobs

The synthesizer parameters are adjusted using controls such as knobs, switches and numerical displays. A specific control is selected by clicking on it. A coarse adjustment is obtained by click-holding the parameter and moving the mouse, or the finger on a track pad, either upwards and downwards or leftwards and rightwards. The value of the parameter replaces its label while it is being adjusted. Double clicking on a knob brings it back to its default value when available.

Fine adjustment of a control is obtained by holding down a modifier key of the computer keyboard (Shift, Ctrl, Command or Alt key) while adjusting the parameter. Note that there is one exception to this in the **Strings** module where pressing the Ctrl key on Windows or Command key on Mac OS and turning a knob sets the value for all strings at once. Precise values can also be entered manually by clicking on the parameter label and typing the value on the computer keyboard.

5.1.2 Switches

Switches are turned *on* or *off* by clicking on them. They are used to activate or deactivate modules and the *sync* feature of some parameters.

5.1.3 Drop-down Menus

Some displays reveal a drop-down menu when clicking on them. Adjustment of the control is obtained by clicking on a selection.

5.1.4 Modulation Signals

The *Velocity* modulation knobs are used to modulate the value of a parameter depending on the velocity signal received from the keyboard so that the value of a parameter increases as notes are played harder on the keyboard. The position of the knob is used to adjust the amount of modulation applied to the parameter. In its leftmost position, the modulation source is turned *off* and the value

of the parameter does not vary with the velocity signal from the keyboard. Turning the knob clockwise increases the effect of the modulation signal on the value of the parameter.

5.1.5 Synchronisation

The rate of certain effect modules and the tempo of loops can be synchronized to the clock of a host sequencer or controlled using the built-in **Clock** module. In order to synchronize effect modules, their *Sync* must be turned *on*. Synchronization values for effects are adjusted with the *Sync Rate* parameter and range from 4 whole notes (16 quarter notes) to a thirty-second note (1/8 of a quarter note) where the duration of the whole note is determined by the host sequencer clock. The effect can also be synced to a triplet or dotted note. To adjust this parameter, click on the *Sync Rate* button and choose a rate value from the drop-down menu.

In standalone mode, the master clock is that from the **Clock** module on the *Play* view and the duration of a whole note is adjusted using the *Rate* control of the **Clock** module or the *Tap Tempo* pad. In plug-in mode, the master clock is that of the sequencer when the *Sync to Host* button is switched *On*. When it is in its *off* position, the tempo is controlled by the internal **Clock** module using the *Rate* control.

5.2 The Play View

The *Play* view is where the main performance oriented modules are located. Key parameters from the *Effects* view are also included for quick access. This view is loaded when starting the instrument and can be accessed from another view by clicking on the *Play* button on the top part of the interface.

The middle section of this view allows one to switch *on* and *off* the **EQ**, **Compressor** and **Reverb** as well as the active effect modules. Key effect parameters are also adjustable as presented in the description of the different effect modules in section 5.4



Figure 23: Middle part of the *Play* view for acoustic guitars.



Figure 24: Middle part of the *Play* view for electric guitars.

5.2.1 The Play Mode

The **Play Mode** module allows one to switch between three playing modes: *Keyboard*, *Guitar* and *Loop* mode. In *Keyboard* mode, *Strum GS* plays notes as they are played on the keyboard without trying to voice chords. It is mainly used to play leads and to exactly control the voicing of chords. In *Guitar* mode, *Strum GS* plays in terms of a fretting and picking hand as a guitar player would. Chords played on the keyboard are automatically voiced by *Strum GS* and special strumming keys are used to strum chords and play individual strings. The *Loop* mode is similar to the *Guitar* mode except that the strumming key patterns are played from recorded MIDI files. For more information on the specific keyboard layout and playing techniques for each of these modes, please refer to sections 3.1, 3.2 and 3.3.



5.2.2 Pitch and Modulation Wheel

The MIDI pitch wheel allows one to vary the pitch of the note played. The pitch wheel can be moved with the mouse but it is also automatically connected to the pitch wheel signal received from your MIDI keyboard. The range of the pitch bend is 2 semi-tones up or down by default but can be changed. To adjust the range of the pitch bend, open the MIDI configuration window by clicking on the **MIDI** button located just below the MIDI led in the top part of the interface and use the **Pitch Bend Range** drop-down menu to select the range in semi-tones. Note that pitch bend also includes a *Slide* option. When this option is selected, pitch changes will occur in a discrete manner by semi-tone steps in order to reproduce the effect of a fretting hand finger going over the frets of the fretboard.



The modulation wheel is used to control vibrato. It can be activated on screen or from the modulation wheel of your MIDI controller (MIDI controller number 1). Other parameters can be linked to the modulation wheel using MIDI links as explained in Section 7.2.2. The amount of vibrato in the sound is adjusted using the *Depth* parameter of the **Mod Wheel** module while its speed is controlled using the *Speed* knob.



5.2.3 The Pickups Module

The Pickups module simulates the action of the pickups on the guitar. There are two pickups in Strum, labeled Neck and Bridge, which can be adjusted in various ways in order to obtain tonal colors of different guitar types. The switch on the *Play* view allows one to listen to the signal from the neck or bridge pickup individually or a mix of both signals when the switch is in its middle position.



5.2.4 The Clock Module

This module is used to control the tempo of certain effects of the *Effects* section and loops. In order to synchronize effects, their *sync* button must be switched *on*.

When using *Strum GS* in standalone mode, the clock tempo, in bpm, is set by using the *Rate* knob. The tempo can also be adjusted by clicking at the desired tempo on the *Tap Tempo* pad of the module. Once the new tempo is detected, the value of the *Rate* knob is automatically adjusted. Note that double-clicking on the *Rate* sets the tempo to that of the currently loop pack.



In plugin mode, the *Tap Tempo* pad is replaced by a *Sync To Host* button. When this button is turned *on*, the rate of effects and loops is synchronized with the clock the host sequencer. When switched *off*, the tempo is determined by the value of the *Rate* knob.

5.2.5 Strumming

The *Strumming* module includes parameters which determine how the strumming is performed. The *Speed* parameter controls how rapidly the different strings are played when a strum is triggered. The speed of the strum is increased by turning the knob clockwise. This parameter can be modulated by the keyboard velocity using the *Velocity* knob. In its leftmost position, the speed is always that corresponding to the value of the *Speed* knob. Turning the velocity knob clockwise increases the strumming speed for high keyboard velocities while it reduces the speed for low keyboard velocities.



The *Auto* button is used to switch *on* or *off* the *Auto-Strum* option. It is only active when *Strum GS* is played in *Guitar* mode. When auto-strumming is *on*, chords are triggered with a downstroke as soon as one or more keys is depressed in the *Chord Keys* section. In other words, chords are played without having to use the special strumming keys. When the *Auto-Strum* option is turned *off*, chords are still recognized and voiced by *Strum GS* but the strings are not triggered until strumming keys are used. For more details on how to use the strumming keys, please refer to section 3.2.2.

5.2.6 Chord Display

The *Chord Display* is where *Strum GS* displays the name of the detected chord or note and the corresponding voicing selected. Strings are labeled from lowest to highest as follows:

- String 6: E (second E below middle C, MIDI note number 40)
- String 5: A (second A below middle C, MIDI note number 45)
- String 4: D (first D below middle C, MIDI note number 50)
- String 3: G (first G below middle C, MIDI note number 55)



- String 2: B (first B below middle C, MIDI note number 59)
- String 1: E (first E above middle C, MIDI note number 64)

Notes played are identified by a circle on the corresponding string and the position on the fretboard is determined by the fret number appearing in the upper left corner of the display. When a string is triggered, its number is highlighted at the bottom of the display while it vibrates. For a list of all the chords detected by *Strum GS*, please refer to section 9.

The name of the detected chord is displayed at the top of the display. When the chord contains no third or no fifth the corresponding *no 3* or *no 5* message is highlighted. While *Strum GS* can recognize a great variety of chords and find most voicings used by guitar players, it is possible that it will not find a voicing in its chord database for a particular chord played on the keyboard. In these cases, the *no match* message is lit. In this case, *Strum GS* will not display a chord name but still propose a guitar voicing constructed according to a certain set of rules. The chord should still sound right but the message is displayed in order to indicate that the voicing chosen by *Strum GS* is probably very difficult to play on the guitar and might therefore not be commonly used by guitar players.

5.2.7 Chord Voicing

On the guitar, chords can be voiced in many different ways. The specific voicing chosen by *Strum GS* for a chord depends on the *Type* parameter. One can choose between open, movable, powerchords, and drop chords. For more information on the effect of these different chord types please refer to section 3.4. The voicing can be made more precise by using the *Position* parameter which instructs *Strum GS* on which neck position the chords should be played. The position is specified in fret number and indicates the lowest fret on which the lowest note of the chord should be played. It is not always possible to satisfy this constraint and *Strum GS* will respect this position whenever it is possible. This parameter is only valid for movable and drop chords as well as powerchords and it is therefore inactive when open chords are chosen.

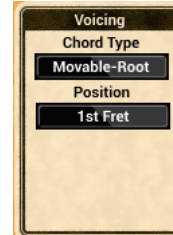

5.2.8 Loops Module

The **Loops** module is used to play *Strum GS* with MIDI loops and it is only active when the *Loop* mode is selected. Loops contain strumming key patterns that are applied over the chords that are played in the *Chord Keys* section of the keyboard.

Strum GS presets are saved with packs of seven loops which are triggered using the white keys from the *Loop Keys* section of the keyboard as described in section 3.3. Loop packs are grouped into banks which can be browsed



using the *Bank* drop-down menu. Individual packs in a bank are selected using the *Pack* drop-down menu. Selecting a pack automatically loads the seven loops included in a pack and maps them to the white keys of the *Loop Keys* section of the keyboard. A specific loop is selected and triggered by depressing one of these keys. The intended tempo of the loops in BPM, its time signature, and information on location within the loop appear just below the loop pack name.

Clicking on the *Show Files* button opens a Finder or Explorer window (on Mac OS X or Windows respectively) at the location where the MIDI loop files are stored. Banks correspond to folder names and loop packs under these categories are stored in these folders. Loops in a pack all share the same name except for the note (letters A to B) used to trigger a specific loop which is appended the loop name.

Once a loop is triggered, it is played at the tempo set by the *Clock* module or that of the host sequencer as explained in section 5.2.4. The tempo of the loop can be halved or doubled by using one of the *Tempo* buttons located below the pack name. Once triggered, loops play until the notes held in the *Chord Keys* sections are released or if the B \flat or second C of the *Loop Keys* section is depressed. The difference between these two keys is that the B \flat , *Mute* key mutes all strings and the sound stops as soon as the key is depressed. When the C or *Stop* key is used, the loop stops but the sound is allowed to decay naturally.

Loops can easily be dragged and dropped unto a sequencer track, the computer desktop or a specific folder by using the *MIDI Drag* control located below the **Loops** module. Click holding anywhere on this control selects the loop currently being played (the one corresponding to the purple key in the *Loop Keys* section) allowing to drag it where desired. Note that once a loop is copied onto a track, *Strum GS* should be used in *Guitar* mode for playback so that the keyswitch pattern that was copied is played correctly. For more information and tips on how to use and edit loops in a project, please refer to section 3.3.

5.2.9 Keyboard

The lower part of this view includes a keyboard covering five octaves. The specific layout of this keyboard depends on the playing mode selected allowing one to easily see how the keyboard is mapped in each mode as described in chapter 3. In *Guitar* and *Loop* mode, more information on the effect of individual notes can be obtained by clicking on the question mark appearing in the end sections of the keyboard. Clicking on the individual notes of this keyboard has the same effect as depressing the same note on an external MIDI keyboard. This can be useful to test *Strum GS* when no MIDI keyboard is connected to your computer.



5.3 The Edit View

This mode allows one to view and adjust all the parameters used by the synthesis engine. While for most applications, simply using the presets will be sufficient, one might want in certain cases to access the different instrument parameters and control them precisely. It can also be a lot of fun to explore the effect of the different parameters and create your own guitars.

5.3.1 The String Module

The parameters of each of the six strings of the guitar can be adjusted independently. Strings are numbered from 6 to 1 with 6 being the lowest string (second E below middle C, MIDI note number 40) and 1 being the highest one (first E above middle C, MIDI note number 64). Clicking on the tabs with different string numbers on the left of the module reveals parameters for this specific string. Note also that parameters of a given string can be copied from one to another by clicking on the down-pointing arrow located to the right of the string number at the top of the module. Multiple strings can also be adjusted at once by interpolating parameters between the strings. This can usually be a good starting point when trying new configurations. It is also interesting to know that the value of a parameter can be adjusted for all the strings at once by clicking on the Ctrl key on Windows or Command key on Mac OS and adjusting the corresponding knob.

The vibrational motion of a string can be decomposed into two different components, one perpendicular to the plane of the body of the guitar and the other one parallel to that plane. At the bridge, the string is fixed and energy is transferred to the body of the guitar but also exchanged between these two components of the string motion. This exchange is responsible for both the characteristic beating effect present in the sound of the guitar and the typical decay curve or envelope of the sound. Both these motion components are modeled in *Strum GS* and they are referred to as motion component *H* (horizontal - parallel component) and *V* (vertical - perpendicular component).

For each motion component, one can adjust three parameters called *Decay*, *Tone* and *Inharm*. The *Coupling* knob is used to adjust the amount of energy exchanged between the two polarities of the string motion. Turning this knob clockwise increases the coupling and therefore the amount and frequency of the beating in the sound. When in its zero position, there is no coupling between the two motion components. Both exist but are completely independent of each other resulting in a sound with no beating and a regular decay envelope. The *Balance* knob is used to control the mix between both components in the output sound. In its leftmost position, one only hears component *V* while in its rightmost position only component *H* is heard. In its middle position, an equal mix of both is heard. In general, to get the most realistic realistic sound, the knob should be turned toward the left or in other words one should listen more to component *V*. This is because in a real



guitar, vibrational motion perpendicular to the body is more efficiently transmitted. Interesting effects can however be obtained by mixing both motion components. Note that even when the balance knob is fully turned to the left, coupling between both components is still taken into account as soon as the *Coupling* knob is turned to the left which will introduce beating in the sound of component *V*.

In a real string, the material of the string affects how it vibrates. For example, a metal string oscillates for a longer time than a nylon one; its sound also contains more high frequencies and is brighter. This behavior is adjusted with the *Tone* and *Decay* knobs. The *Tone* knobs are used to set the respective amount of high frequencies in components *V* or *H* of the string motion with respect to low frequencies. In their zero position, the decay time of high frequencies in the sound is lower than that of low frequencies; turning them clockwise makes it longer. The overall decay time of the vibrations is controlled with the help of the *Decay* knobs and it is increased by turning the knobs towards higher values. As a rule of thumb a nylon string is obtained by setting the *Tone* knobs to a low value and using a low decay time. Increasing the value of this two parameters results in a more metallic sound.

In a first approximation, the strings of a guitar can be considered to be harmonic meaning that their partials are located at frequencies equal to multiples of the fundamental frequency. Real strings, however, are more or less inharmonic depending on the homogeneity of the strings along their length. This characteristic of strings is adjusted, for components *V* and *H*, with the *Inharm* knobs. When these knobs are in their zero position, the string vibration is perfectly harmonic. Turning the knobs clockwise increasingly detunes the partials toward higher frequencies resulting in a more dissonant sound.

5.3.2 The Pick Module

The *Pick* module allows one to control the parameters related with the excitation of the string. It can simulate the excitation of the string with a pick or with a finger. Three different pick or plectrum models are implemented in *Strum GS* as shown in Figure 25, 26 and 27 each of them corresponding to a different plectrum profile. The first two models are better to simulate the interaction of the string with a hard pick while the third one is better to simulate the interaction with a smoother object such as a smooth pick or a finger. The plectrum model is chosen using the *Type* selector.

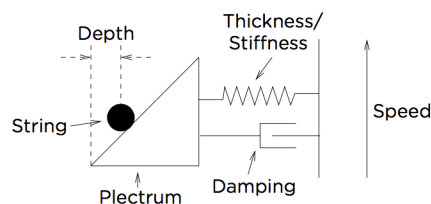

Figure 25: First pick model

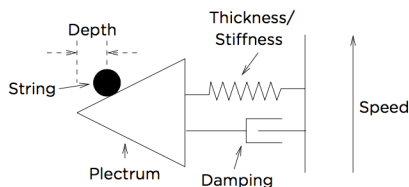

Figure 26: Second pick model

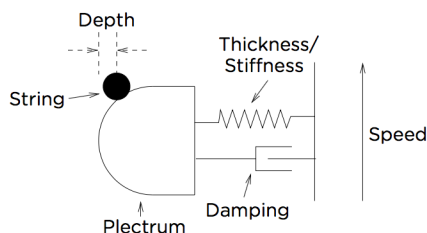

Figure 27: Third pick model

The excitation force produced by the plectrum when interacting with the string is determined by the *Depth*, *Speed*, *Stiffness* and *Damping* parameters. The *Stiffness* and *Damping* parameters determine the flexibility of the plectrum or in other words the resistance it exerts against the string. Increasing the value of these parameters will mainly increase the amplitude of the sound. The *Stiffness* parameter is used to control the stiffness of the plectrum used. Increasing this parameter, by turning the knob clockwise, results in thicker or stiffer plectrum. The *Damping* parameter controls the amount of damping in the plectrum. The parameter is mainly effective during the attack of notes. Raising its value, by turning the *Damping* knob clockwise, results in additional impact noise when the plectrum first comes into contact with the string when attacking a note. These two parameters are modulated with the note velocity through the use of the *Velocity* knob below them. When the knob is in its leftmost position, there is no modulation from the MIDI note velocity; turning this knob clockwise gradually increases the amount of modulation.



The *Depth* parameter enables one to control the distance between the edge of the plectrum and the string when they come into contact. In other words it simulates how far behind the string, a guitar player introduces the plectrum before picking the string. This parameter affects the loudness and the spectral content of the sound as well as the interaction time between the plectrum and the string. The *Speed* knob is used to control the speed of the plectrum relative to the string. The main effect of this parameter is to determine the interaction time between the plectrum and the string. This parameter can also be modulated with the MIDI note velocity signal using the *Velocity* knob below.

The *Edge* parameter is used to determine the sharpness of the edge of the pick. It is used to

fine-tune the profiles of the three different plectrum models which affects the shape of the force signal exerted by the plectrum on the string and therefore the tone of the resulting sound. Turning this knob towards higher values makes the pick sharper with more high frequencies in the tone. Finally, the *Position* knob is used to control the position of the interaction point of the plectrum along the string. This is a parameter currently used by guitar players to change the tone of the sound. In its zero position, the pick is very close to the bridge resulting in a more metallic sound. Turning the knob toward higher values moves the pick toward the fretboard resulting in a rounder sound.

5.3.3 The Hammer-On module

The *Hammer-On* module is used to control hammer-on et pull-off. Hammer-on and pull-off are playing techniques used by guitar players to play legato or grace notes. The hammer-on effect is obtained by first picking a note and then hammering down another finger onto the same string at a higher fret. The pull-off effect is almost the opposite of the hammer on. It is obtained by first picking a note and then sharply pulling-off the finger from the fretboard in order to hear a second fretted note on the same string. The sounds produced using these techniques are softer and less percussive than the ones produced by picking the notes.



In *Strum GS*, hammer-ons and pull-offs are triggered when playing in *Keyboard* mode and when legato playing is detected. The two parameters of this module are *Amp* and *Tone*. The *Tone* knob is used to set the harmonic content of the excitation produced by the finger moving on the string as explained above. Turning this knob to the left results in a smoother sound while turning it clockwise results in a sharper sound. The *Amp* parameter controls the amplitude of the excitation generated by hammer-ons and pull-offs.

5.3.4 The Mute Module

In *Strum GS*, strings are muted when the keys forming a chord are released, when a muffled down/up is used (F \sharp , G \sharp strumming key in *Guitar* mode or when the mute strumming key (A \sharp) is depressed in *Guitar* or *Loop* mode. This reproduces the muting effect obtained by guitarists when releasing the pressure on the notes held by the fretting hand. The pressure applied on a given string is controlled using the *Contact* knob. In its leftmost position, the contact is very light and one can slightly hear the sound of the open string. When this knob is in its rightmost position, the pressure between the finger and the string is strong and one can hear the pitch of the fretted note. In its middle position, the string is muted efficiently and one can, depending on the fret where the finger is located, hear harmonics ringing. The tone and decay time of these harmonics are set using the *Tone* and *Decay* knobs which fix the decay time and the spectral content of these tones respectively. When muting a string it takes a little time for the guitar player to release the pressure on the finger on the string in order to place them in



muting position. This time is set using the *Time* knob and the release time is increased by turning the knob clockwise.

5.3.5 The Palm Module

In *Guitar* mode, palm muting is achieved by using the palm mute strumming key (C#). The resulting sound of this effect can be adjusted with the help of the *Decay* and *Tone* parameter. The *Decay* knob is used to set the decay time of the sound when the strings are palm muted. In other words, it controls the amount of overall damping induced by the picking hand. Turning this knob clockwise increases the decay time. The *Tone* knob controls the amount of high frequencies in the resulting sound relatively to the amount of low frequencies or in other words the tone of the sound. Turning this knob towards higher values increases the amount of high frequencies in the sound.



5.3.6 The Body Module

The **Body** module simulates vibrations of the top plate of the body of an acoustic guitar, or soundboard, and that of the air cavity of the body. The soundboard of the body is efficient at radiating a large range of frequencies while the role of the air cavity is to boost low frequencies. A *Tone* knob is provided for the plate while a *Decay* knob is provided for both the plate and air cavity of the body. The *Tone* parameter is used to control the decay time of high frequencies with respect to that of low frequencies. This takes into account the fact that depending on the material, the decay time varies for different frequency components of the sound. In its leftmost position, the decay time of high frequencies in the sound is lower than that of low frequencies; in its rightmost position it is longer. The overall decay time of the both the air cavity and plate vibrations is controlled with the help of the two *Decay* knobs and it is increased by turning the knobs clockwise.



The *Size* drop-down menu allows one to choose the size of the body. Basically, reducing the size of the body shifts its frequency response toward higher frequencies while increasing it results in a shift toward lower frequencies. Finally, the *Low Cut* parameter allows one to control the low frequency response of the body. Increasing the value of this parameter decreases the low frequency content radiated by the body.

5.3.7 The Pickups Module

The **Pickups** module simulates the action of the pickups on the guitar. There are two pickups in *Strum*, labeled *Neck* and *Bridge*, which can be adjusted in various ways in order to obtain tonal colors of different guitar types. They are activated by using the *Neck* or *Bridge* buttons or the *Pickups* switch on the *Play* view.

The *Type* selector allows one to choose between single coil or humbucker pickups. Single coil pickups are made, as their name suggest, from a single coil wounded around a permanent magnet. While this type of pickup sounds great it has the disadvantage on a real guitar that it transmits, in addition to the signal from the vibrating string, mains hum at the frequency of the mains alternating current. In order to overcome this effect a clever device, known as the humbucker pickup, was developed. Basically, a humbucker pickup consists of two single coil pickups with opposing windings and polarities wired in series. This arrangement results in a reduction of the ambient noise by destructive interference while the signal from the strings is amplified due to constructive interference. But noise reduction is not the only effect of using two coils. This configuration also changes the tone of the pickup which is responsible for the characteristic tone of specific guitar types. Humbucker pickups typically produce a “warm” and “fat” tone while single coil pickups usually sound “brighter” and “clearer”.

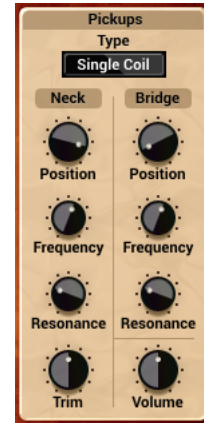

The electric signal from the pickup is sent to the amplifier via a simple electric circuit and a cable. The combined inductance, capacitance and resistances of this circuit form a resonant low-pass filter. The quality factor and the cut-off frequency of this circuit can be adjusted for each pickup using the *Frequency* and *Resonance* knobs respectively allowing one to further adjust the tone of the guitar signal.

The position of each pickup can also be adjusted from bridge to neck position using the *Position* knob. It is common, in different guitar types to listen to a single pickup at each of these position or to mix the signal from the bridge and neck pickups or to combine one of these with the signal from a third one positioned in the middle. On a real guitar, one can choose between these different configurations using switch on the body of the instrument.

Finally, another parameter which affects the sound of the guitar is the relative amplitude of the signal from each pickup. On a real instrument this is controlled by adjusting the vertical distance between the pickups and the strings. In *Strum* this is adjusted using the *Trim* knob which allows one to vary the amplitude of the neck pickup from -10 dB (leftmost position) to 10 dB (rightmost position).

5.4 The Effects View

The *Effects* view is displayed by clicking on the *Effects* button in the utility section at the top of the interface and is based around a **Multi-effects** module.

The **Multi-Effects** module allows one to process and shape the signal from the guitar before sending it to the output. This module comprises an **EQ** and a **Compressor** in series with two configurable effect processors followed by a **Reverb** module. The configuration of the **EQ** and the **Compressor** module depends on the position of the *SC* and *Pre* buttons of these modules as will be explained below. The two effect processors can be set to a different type by using the drop-down menu located at the center of each module for a wide range of possibilities. The effect list includes a **Delay**, **Distortion**, **Chorus**, **Flanger**, **Phaser**, **Wah Wah**, **Auto Wah** and a **Notch** filter. The order of the effect modules in the signal path can be changed by click-dragging the handles located on the left of the modules.

The **Multi-Effects** module is also visible from the *Play* view just below the utility section. This allows one to see rapidly which effects are selected for a given sound, turn the effects *on* or *off* and rapidly adjust the amount of each effect. The **Compressor**, **Equalizer** and **Reverb** can also be adjusted from this view.

5.4.1 EQ

The **EQ** module provides equalization over the low, mid, and high frequency bands. It is composed of a low shelf filter, two peak filters, and a high shelf filter in series, labelled **LF**, **LMF**, **HMF**, and **HF** respectively.



The functioning of the low shelf filter is depicted in Figure 28. The filter applies a gain factor to low frequency components located below a cutoff frequency while leaving those above unchanged. The cutoff frequency of this filter is adjusted using the *Freq* knob and can vary between 40 and 400 Hz. The *Gain* knob is used to adjust the gain factor applied to the signal in a ± 15 dB range. In its center position there is no attenuation (0 dB). Turning it clockwise boosts the amplitude of low frequencies while turning it anti-clockwise reduces it.

The high frequency content of the signal is controlled with a high shelf filter that works in the opposite manner as the low shelf filter as illustrated in Figure 28. The filter applies a gain factor to components located above a cutoff frequency while leaving those below unchanged. The cutoff frequency of this filter, located above 1 kHz, is adjusted with the help of the *Freq* knob while the gain factor applied to the signal, in a ± 15 dB range, is adjusted using *Gain* knob. In its center position there is no attenuation (0 dB). Turning it clockwise boosts the amplitude of high frequencies while turning it anti-clockwise reduces it.

The **EQ** module features two peak filters, labeled **LMF** and **HMF**, allowing to shape the signal in two frequency bands as illustrated in Figure 29. The filters apply a gain factor to frequency components in a band located around the cutoff frequency of the filters. This cutoff frequency is adjusted using the *Freq* knob and can vary between 100 Hz and 10 kHz. The gain factor applied at the cutoff frequency is controlled by the *Gain* knob and can vary in a ± 15 dB range. When

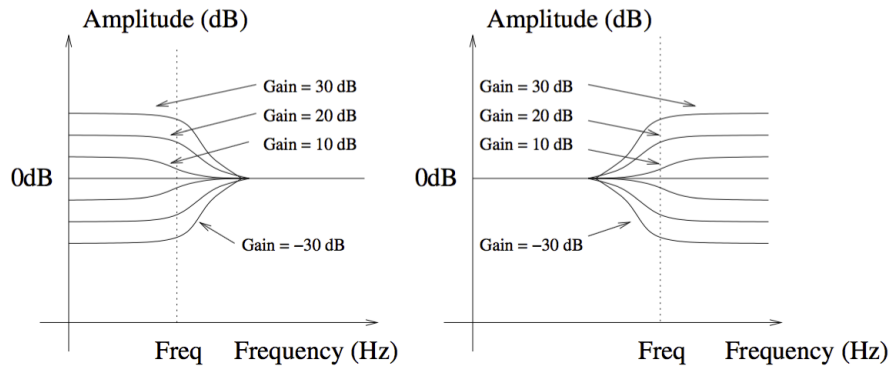

Figure 28: Low and high shelf filters.

in its center position there is no attenuation (0 dB). Turning it clockwise boosts the amplitude of frequencies located around the cutoff frequency while turning it anti-clockwise reduces it. The Q knob is used to adjust the so-called quality factor of the filter which controls the width of the frequency band on which the filter is active. In its leftmost position, the frequency band is wide and it gets narrower as the knob is turned clockwise.

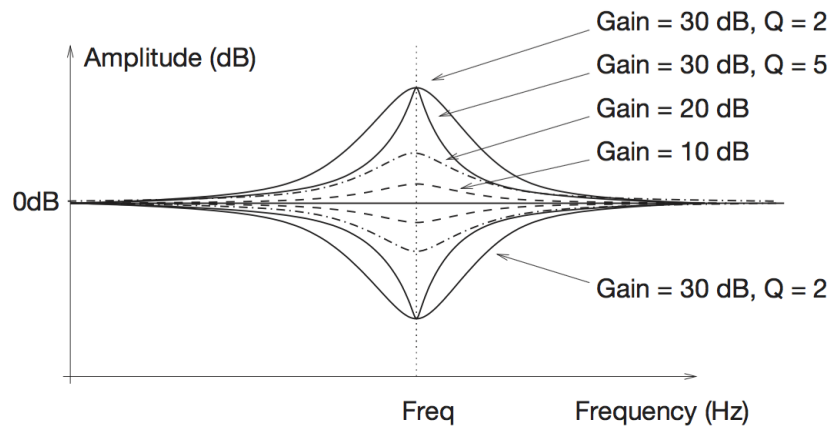

Figure 29: Peak filter.

The *SC* button (side-chain) is used to determine if the output from the **EQ** module is to be used as the control signal of the **Compressor** module as described in Section 5.4.2. Finally, note that all the gain knobs from this module can be accessed directly from the *Play* view.

5.4.2 Compressor

The **Compressor** module is used to automatically compress, in other words reduce, the dynamics of a signal. This module receives two input signals. The first one is the signal to be compressed

while the second one is a control signal which triggers the compression process when it rises above a given level.



Tuning

The level at which the **Compressor** starts to enter into action is determined by the value of the *Threshold* parameter. This value is in dB and corresponds to the amplitude of the input signal as monitored by the first level meter of the module.

The amount of compression applied to the part of the signal exceeding the threshold value depends on the *Ratio* parameter which varies between value of 1:1 and 1:16. This parameter represents the ratio, in dB, between the portion of the output signal from the compressor above the threshold value and the portion of its input signal also exceeding the threshold value. As one might expect, increasing the ratio also increases the amount of compression applied to the signal. For example, a ratio of 1:5 means that if the input signal exceeds the threshold by 5 dB, the output signal will exceed the threshold by only 1 dB. Note that the *Ratio* parameter can also be adjusted from the *Play* view.

Two other controls affect the behavior of the **Compressor**. The *Attack* knob is used to set the time, in milliseconds, before the **Compressor** fully kicks in after the level of the input has exceeded the threshold value. A short value means that the compressor reaches the amount of compression as set by the *Ratio* knob rapidly. With a longer attack, this amount is reached more gradually. In other words, the attack time is a measure of the attack transient time of the compression effect. The **Release** parameter is similar and represents the amount of time taken by the **Compressor** to stop compressing once the amplitude of the input signal falls below the threshold value.

The **Makeup** knob is used to adjust the overall level at the output of the **Compressor** module and is used to compensate from an overall change in signal level due to the compression effect.

The location of the **Compressor** in the signal path depends on the setting of the *Pre* button. When this parameter is *on*, the **Compressor** is located at the output of the synthesizer, just before the **EQ** module. In this position, the input signal of the **Compressor** and its control signal are both the output signal from the synthesizer. When the **Pre** button is *off*, the **Compressor** is located after the **EQ** module. In this configuration, the control signal of the **Compressor** is then the output signal from the **EQ** module while the input signal to the compressor is determined by the position of the **SC** button. When it is *on*, the **Compressor** is in a *side-chain* configuration. The input signal of the **Compressor** is then the output signal from the synthesizer. When it is *off*, the input signal of the **Compressor** is the output signal from the **EQ** module.

Using the compressor in side chain configuration is useful when one wants to trigger the compressor using other criteria than the general level of the signal to be compressed. For example, a sound with a lot of bass would easily trigger the **Compressor** when playing low notes. In order

to avoid that, the **EQ** module would be set to filter out low frequency components. This signal would then be used to control the **Compressor** while the input signal to the **Compressor** would still include these low frequency components.

The attenuation or gain reduction level meter, located in the middle of the module, indicates the amount of compression applied by the module. It is the difference between the input and output signals of the module before makeup gain is applied.

5.4.3 Amplifier



Strum GS is equipped with a versatile 2-channel amplifier with speaker cabinet and spring reverb. With relatively few parameters, this amplifier module allows one to obtain a rich variety of sounds for different music styles. This module is available from the *Play* view when an electric guitar preset is loaded.

The amplifier section of this module is switched *on* or *off* by clicking on the LED located in the top right corner of the module. The *Channel* LED allows one to switch between the two channels of the amplifier. Channel one offers clean to semi-dirty sound while channel two is well-suited when strong distortion is required. The *Drive* knob is used to adjust the amount of distortion in the sound. The sound becomes more and more distorted as the knob is turned clockwise. The *Mid* knob is used to set the amount of mid-range frequencies in the sound. In its middle position, the sound is not modified, mids are cut or boosted by up to ± 12 dB by turning this knob to the left or right. The *Level* knob is a gain knob which is used to adjust the overall volume of the amplifier. Note that the effect of this control on the frequency response of the amplifier is different for each channel.

The *Low* and *High* parameters are used to boost or cut low and high frequencies respectively by up to *pm* 18dB by turning the knob from its center position. These controls have a similar behavior for both channels. Additional control on the frequency response is obtained by using the *Bite* control which is switched *on* or *off* by clicking on the *Bite* LED just before to the channel selector. This parameter boosts high frequencies while cutting some low frequencies for a brighter sound.

The low-cut (or high-pass) filter is used to remove from the output sound of the instrument frequency components below the cut-off frequency. The cut-off frequency of the filter is increased by turning the knob clockwise. when this knob is in its leftmost position, the filter has no effect on the sound.

The spring reverb is turned *on* or *off* by using the *spring* LED in the right section of the amplifier. The *Mix* knob is used to set the amount of wet signal in the mix, turning the knob clockwise increasing the amount of reverberation in the signal.

Finally, the speaker cabinet is switched *on* or *off* by clicking on the LED in the upper right corner of the cabinet section of the module. This part of the module simulates the effect of both the speaker and the cabinet on the frequency response of the amplifier module. The back of the cabinet can be open or closed using the *Type* selector. Opening the back of the cabinet allows waves to travel from the back of the cabinet and interfere with those traveling from the front part of the cabinet resulting in a more colored sound.

5.4.4 Delay

The **Delay** module consists in a stereo feedback loop with a variable delay in the feedback. It is used to produce an echo effect when the delay time is long (greater than 100 ms) or to color the sound when the delay time is short (smaller than 100 ms).

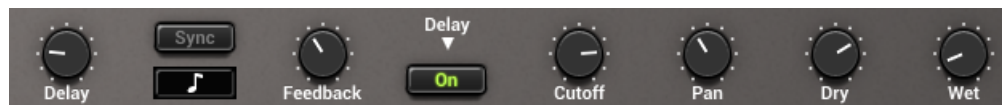

The *Delay knob* is used to adjust the amount of delay, in seconds, introduced by the effect. Turning this knob clockwise increases the delay. The *Feedback* parameter is a gain factor, varying in the range between 0 and 1, applied to the signal at the end of the delay lines. It controls the amount of signal that is re-injected in the feedback loop. In its leftmost position, the value of this parameter is 0 and no signal is re-introduced in the delay line which means that the signal is only delayed once. Turning the knob clockwise increases the amount of signal re-injected at the end of the feedback loop and therefore allows one to control the duration of the echo for a given delay time. In its rightmost position, the gain coefficient is equal to 1 which means that all the signal is re-injected into the feedback loop and that the echo will not stop. In addition to this gain factor, low pass filtering can also be applied to the signal re-injected into the feedback loop. The cutoff frequency of this filter is controlled using the *Cutoff* knob.

The *Pan* knob is used to balance the input signal between the left and right channels. In its leftmost position, signal is only fed into the left delay line and one hears clearly defined echo first from the left channel and then from the right channel and so on. In its rightmost position, the behavior is similar but with the first echo coming from the right channel. These two extreme position correspond to the standard ping pong effect but a less extreme behavior can be obtained by choosing an intermediate position. In particular when the *Pan* knob is in its center position, an equal amount of signal is sent in both channels.

The output signal from the **Delay** module can include a mix of input signal (dry) and delayed signal (wet). The *Wet* and *Dry* knobs are used to adjust the amplitude of each component in the final output. The amplitude of each component is increased by turning the corresponding knob clockwise from no signal to an amplitude of +6dB. Note that the *Wet* parameter is also adjustable from the *Play* view.

5.4.5 Distortion

The **Multi-Effect** module includes three different types of distortion which are selected using the *Shape* selector knob. The *Warm Tube* effect applies a smooth symmetrical wave shaping to the input signal resulting in the introduction of odd harmonics in the signal. The *Metal* distortion is similar to the *Warm Tube* effect but is slightly asymmetrical resulting in the introduction of even and odd harmonics in the signal. The *Solid State* distortion applies an aggressive symmetrical clipping to the signal thereby adding high frequency harmonics and resulting in a harsh sound.



The *Drive* control is a gain knob acting on the input signal. This parameter allows one to adjust the amount of distortion introduced in the signal by controlling how rapidly the signal reaches the non-linear portion of the distortion curve applied on the signal. In its leftmost position, the amplitude of the input signal is reduced by -6 dB; turning this knob clockwise allows one to increase its amplitude. Note that the *Drive* parameter is also adjustable from the *Play* view.

The *Tone* knob is used to adjust the color of the signal after the distortion algorithm has been applied. In its leftmost position, high frequencies are attenuated in the signal while in its rightmost position low frequencies are filtered out from the signal. In its center position, the signal is left unchanged.

The *Volume* knob is a gain knob acting on the amplitude of the distorted signal. Finally, the *Mix* knob allows one to control the amount of dry and wet (distorted) signal in the final output signal from the **Distortion** module. In its leftmost position, there is only dry signal in the output while in its rightmost position one only hears the distorted signal. In its center position, there is an equal amount of dry and wet signal in the output.

5.4.6 Chorus

The chorus effect is used to make a source sound like many similar sources played in unison. It simulates the slight variations in timing and pitch of different performers executing the same part. The effect is obtained by mixing the original signal with delayed version obtained from the output of delay lines as shown in Figure 30. In the case of a chorus effect, the length of the delay lines must be short in order for the delayed signals to blend with the original signal rather than be perceived as a distinct echo. The length of the delay line can be modulated introducing a slight perceived pitch shift between the voices.

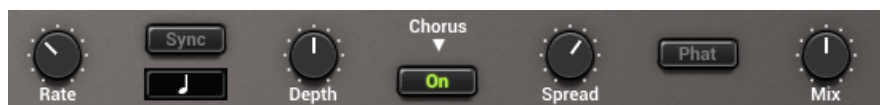

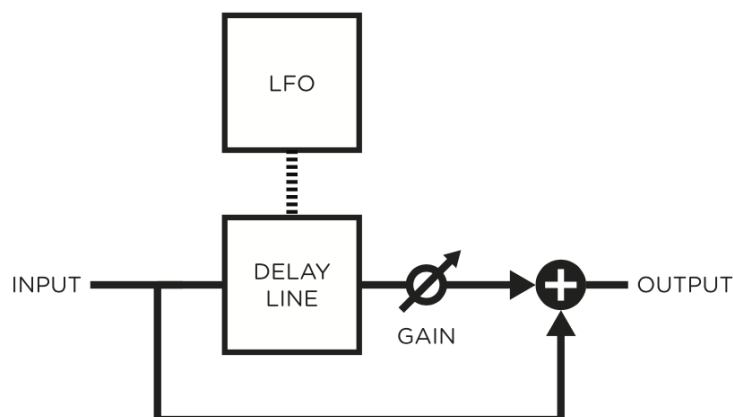

Figure 30: **Chorus** module.

Tuning

The amount of modulation of the length of the delay lines is adjusted using the *Depth* knob. In the left position, there is no modulation and the length of the delay lines remains constant. As the knob is turned to the right, the length of the delay line starts to oscillate by an amount which increases as the knob is turned clockwise thereby increasing the amount by which the different voices are detuned. The frequency of the modulation is fixed with the *Rate* knob.

The *Fat* button is used to control the number of voices in the chorus effect. Switching this button *on* increases the number of voices. The *Spread* knob is used to adjust the amount of dispersion of the different voices in the stereo field. When in its leftmost position, there is an equal amount of left and right output signal on each channel. In other words the signal is the same on both channels. In its rightmost position, there is complete separation between the channels, the left output from the chorus is only sent to the left channel while the right output of the chorus is only sent to the right channel. Finally, the *Mix* knob allows one to mix the dry and wet signals. In its leftmost position, there is no output signal from the chorus and one only hears the dry input signals. In its rightmost position, one only hears the wet signal from the chorus module. In its center position, there is an equal amount of dry and wet signal in the output signal from the module.

Note that *Strum GS* includes a second chorus algorithm called *vintage chorus* which sounds differently and also produces a flanging effect different from that in the actual **Flanger** module.

5.4.7 Flanger

The **Flanger** module implements the effect known as *flanging* which colors the sound with a false pitch effect caused by the addition of a signal of varying delay to the original signal.



The algorithm implemented in this module is shown in Figure 31. The input signal is sent into a variable delay line. The output of this delay is then mixed with the dry signal and re-injected into the delay line with a feedback coefficient.

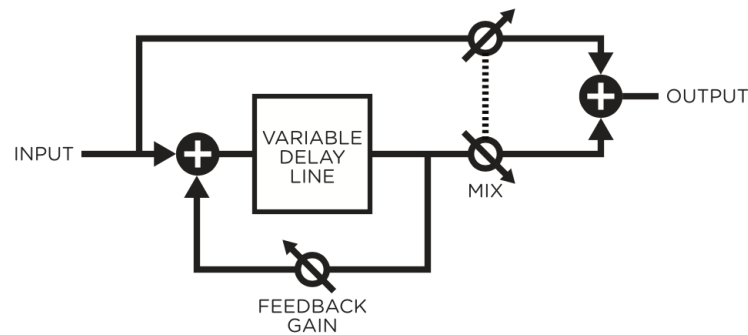

Figure 31: **Flanger** algorithm.

The effect of the **Flanger** module is to introduce rejection in the spectrum of the input signal at frequencies located at odd harmonic intervals of a fundamental frequency as shown in Figure 32. The location of the fundamental frequency f_0 and the spacing between the valleys and peaks of the frequency response is determined by the length of the delay line ($f_0 = 1/(2\text{delay})$), the longer the delay, the lower is f_0 and the smaller the spacing between the harmonics while decreasing the delay increases f_0 and hence the distance between the harmonics.

The amount of effect is determined by the ratio of wet and dry signal mixed together as shown in Figure 33. As the amount of wet signal sent to the output is increased, the amount of rejection increases. Finally, the shape of the frequency response of the **Flanger** module is also influenced by the amount of wet signal re-injected into the feedback loop as shown in Figure 34. Increasing the feedback enhances frequency components least affected by the delay line and located at even harmonic intervals of the fundamental frequency. As the feedback is increased, these peaks become sharper resulting in an apparent change in the pitch of the signal.

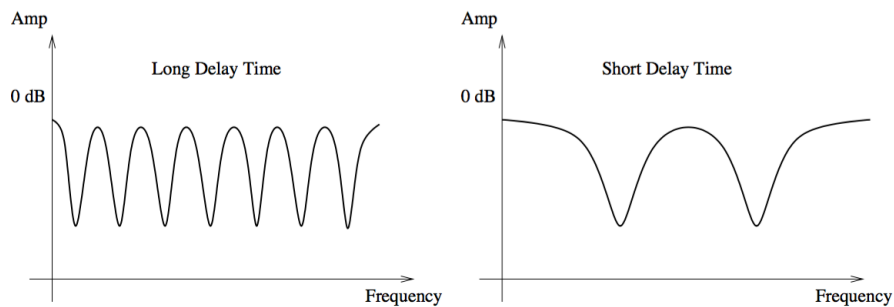

Figure 32: Frequency response of a **Flanger** module. Effect of the length of the delay line.

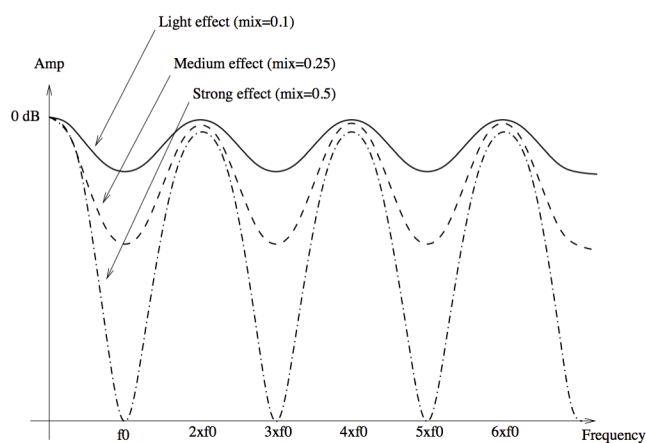

Figure 33: Effect of the mix between wet and dry signal on the frequency response of a **Flanger** module

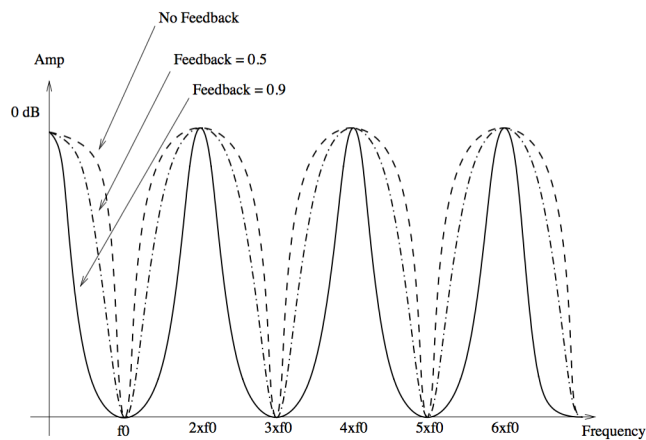

Figure 34: Effect of the amount of feedback on the frequency response of a **Flanger** module.

Tuning

The delay length, in milliseconds, is adjusted with the *Delay* knob. The length of this delay can be modulated by a certain amount depending on the adjustment of the *Depth* knob. In the left position, there is no modulation and the length of the delay line remains constant. As the knob is turned to the right, the length of the delay line starts to oscillate by an amount which increases as the knob is turned clockwise and at a frequency fixed with the *Rate* knob. The *Feedback* knob is a gain knob used to fix the ratio of wet signal re-injected into the delay. Finally, the *Mix* knob determines the amount of dry and wet signal in the output signal from the module. When this knob is adjusted in its leftmost position, only dry signal is sent to the output, in its center position, there is an equal amount of dry and wet signal in the output signal while in its rightmost position, only wet signal is sent to the output. Note that the *Depth* parameter is also adjustable from the *Play* view.

5.4.8 Phaser

The **Phaser** module implements the effect known as *phasing* which colors a signal by removing frequency bands from its spectrum. The effect is obtained by changing the phase of the frequency components of a signal using an all-pass filter and adding this new signal to the original one.



The algorithm implemented in this module is shown in Figure 35. The input signal is sent into a variable all-pass filter. This wet signal is then mixed down with the original dry signal. A feedback line allows the resulting signal to be re-injected into the filter. The effect of the **Phaser** module is to introduce rejection in the spectrum of the input signal depending on the tuning of the filter.

The all-pass filter modifies a signal by delaying its frequency components with a delay which increases with the frequency. This phase variations introduce a certain amount of cancellation when this wet signal is mixed down with the original dry signal as shown in Figure 36. The rejection is maximum when the phase delay is equal to 180 degrees and a given component is out of phase with that of the original signal. The amount of effect is determined by the ratio of wet and dry signal mixed together as shown in Figure 36. As the amount of wet signal sent to the output is reduced, the amount of rejection increases. The shape of the frequency of the Phaser module is also influenced by the amount of wet signal re-injected into the feedback loop. Increasing the feedback enhances frequency components least affected by the all-pass filter. As the feedback is increased, these peaks become sharper. The functioning of the **Phaser** is very similar to that of the **Flanger** module. The filtering effect is different however, since the **Phaser** module only introduces rejection around a limited number of frequencies which, in addition, are not in an harmonic relationship.

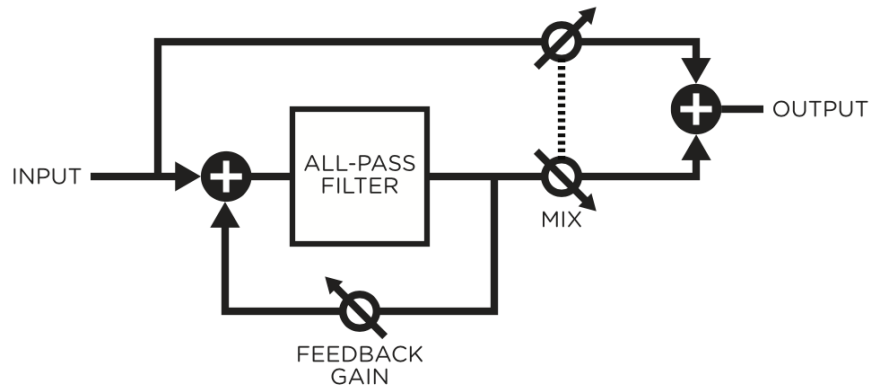

Figure 35: **Phaser** algorithm.

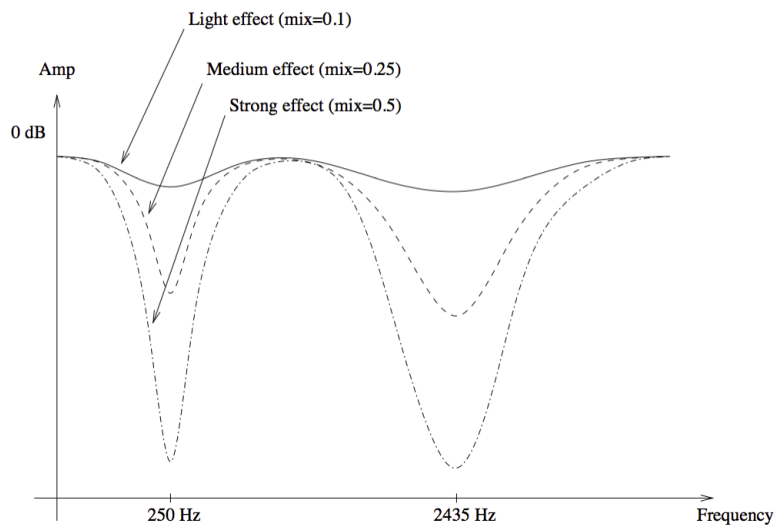

Figure 36: Frequency response of a **Phaser** module. Effect of the mix between wet and dry signal on the frequency response.

Tuning

The location of the first notch in the frequency response of the module is adjusted with the *Frequency* knob. This frequency can be modulated by an amount controlled with the *Depth* knob. In its leftmost position, the location of the first notch is fixed but it starts to oscillate by an amount which increases as the *Depth* knob is turned clockwise. The frequency of the modulation is controlled

using the the *Rate* knob. The *feedback* knob is used to fix the amount of wet signal re-injected into the delay. Finally, the *Mix* knob determines the amount of dry and wet signal sent to the output. When this knob is adjusted in the left position, only dry signal is sent to the output, in its center position, there is an equal amount of dry and wet signal in the output and in the right position, only wet signal is sent to the output.

5.4.9 Wah

The Multi-Effect module includes 2 different types of *Wah* effects: wah wah, and auto wah. These effects are used to enhance a frequency band around a varying center frequency using a bandpass filter. In the wah wah effect, the center frequency of the bandpass filter varies at a rate fixed by the user. In the case of the auto-wah, the variations of the center frequency is controlled by the amplitude envelope of the incoming signal.

The *Freq* knob is used to control the central frequency of the filter. Turning this knob clockwise increases the center frequency. In the case of the *Wah Wah* effect, the center frequency oscillates around the value fixed by the *Freq* knob while with the *Auto Wah* effect, the setting of the *Freq* parameter fixes the starting point value of the varying center frequency.



The *Depth* knob controls the excursion of the center frequency of the filter. In the case of the *Wah Wah* effect, this excursion is applied around the value fixed by the *Freq* knob while in *Auto Wah* effect the value of the center frequency increases from the value fixed by the *Freq* knob. Turning this knob clockwise increases the excursion of the center frequency. Note that the *Depth* parameter is also adjustable from the *Play* view.

Finally, the *Rate* knob controls the frequency or rate of the modulation of the center frequency of the filter. In the case of the *Wah Wah* effect, turning this knob clockwise increases the rate of the modulation. In the case of the *Auto Wah* filter, this knob is labeled *Speed* and controls the time constant of the envelope follower. Turning this knob clockwise decreases the time constant, or in other words the reaction time, of the envelope follower.

5.4.10 Notch Filter

The *Notch Filter* does essentially the opposite of a band-pass filter. It attenuates the frequencies in a band located around the center frequency and leaves those outside of this band unchanged as shown in Figure 37. As was the case for the *Wah Wah* effect, the filter can be modulated.



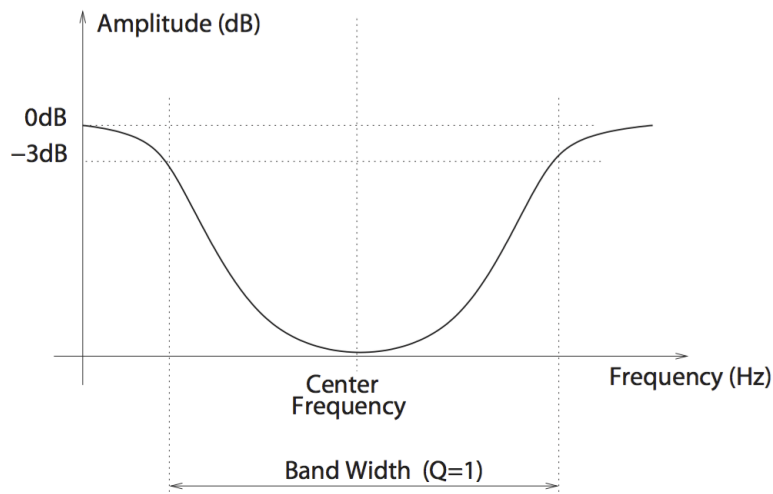
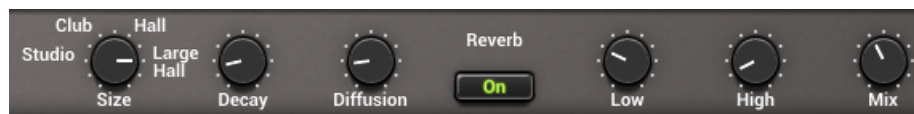

Figure 37: Frequency response of a notch filter.

The *Freq* knobs is used to control the central frequency of the filter. Turning this knob clockwise increases the center frequency. The *Depth* knob controls the excursion of the center frequency of the filter around its center frequency. Turning this knob clockwise increases the excursion of the center frequency. Finally, the *Rate* knob controls the frequency or rate of the modulation of the center frequency of the filter. Turning this knob clockwise increases the rate of the modulation. Note that the *Depth* parameter is also adjustable from the *Play* view.

5.4.11 Reverb

The *Reverb* effect is used to recreate the effect of reflections of sound on the walls of a room or hall. These reflections add space to the sound and make it warmer, deeper, as well as more realistic since we always listen to instruments in a room and thus with a room effect.



Impulse Response of a Room

The best way to evaluate the response of a room is to clap hands and to listen to the resulting sound. Figure 38 shows the amplitude of the impulse response of a room versus time. The first part of the response is the clap itself, the direct sound, while the remaining of the response is the effect of the room which can itself be divided in two parts. Following the direct sound, one can

observe a certain amount of echoes which gradually become closer and closer until they can not be distinguished anymore and can be assimilated to an exponentially decaying signal. The first part of the room response is called the early reflexion while the second is called the late reverberation. The total duration of the room response is called the reverberation time (RT).

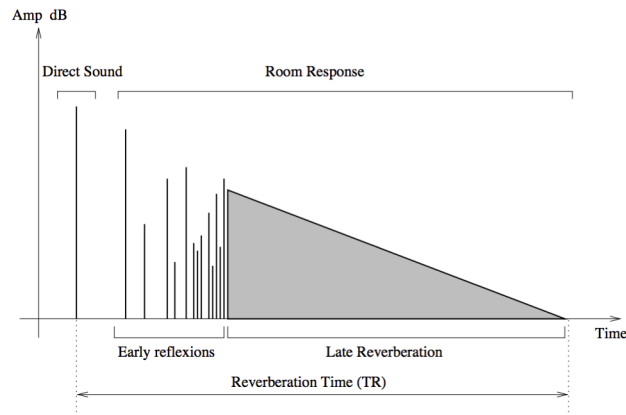

Figure 38: Impulse response of a room.

Adjusting the room effect

The size of a room strongly affects the reverberation effect. The *Size* selector is used to choose between the *Studio*, *Club*, *Hall* and *Large Hall* settings each reproducing spaces of different volumes from smaller to larger.

The duration of the reverberation time depends on both the size of the room and the absorption of the walls, which is controlled with the *Decay* knob. In a real room the reverberation time is not constant over the whole frequency range. As the walls are often more absorbent in the very low and in the high frequencies the reverberation time is shorter for these frequencies. These parameters are adjusted with the *Low* and *High* knobs respectively.

Another parameter which affects the response of a room is its geometry; the more complex the geometry of a room, the more reflexion are observed per unit of time. This quantity is known as the time density and can be set trough the *Diffusion* knob. In a concert hall, the time density is supposed to be quite high in order not to hear separate echoes which are characteristic of poor sounding rooms.

The last parameter which affects our listening experience in a room, is the distance between the sound source and the listener. While the room response is quite constant regardless of the position of the source and the listener, the direct sound (the sound which comes directly from the source) depends strongly on the position of the listener. The farther we are from the sound source the quieter is the direct sound relatively to the room response. The ratio between the direct sound and the room response is adjusted with the *Mix* knob which in other words is used to adjust the

perceived distance between the source and the listener. In its leftmost position, only the direct sound is heard while when fully turned to the right, one only hears the room response. Note that the *Mix* parameter is also adjustable from the *Play* view.

6 Utility Section

The utility section is located at the top of the *Strum GS* interface and it includes important parameters and monitoring tools. For information on *Banks* and *Programs* please refer to Chapter 4.



6.1 The MIDI LED and MIDI configuration

The MIDI LED is located on the left of the level-meter. The LED blinks when the synthesizer receives MIDI signal. If the application is not receiving MIDI signal, make sure that the host sequencer is sending MIDI to *Strum GS*. If you are running in standalone mode, make sure that the MIDI controller you wish to use is well connected to your computer and that it is selected as explained in Section 7.

Clicking on the *MIDI* button just below the MIDI led opens the MIDI configuration pop-up window as shown below. From this window, one can adjust parameters such as the pitch bend range, aftertouch, enable bank and program changes and manage the MIDI map used by *Strum GS* as explained in Chapter 7.

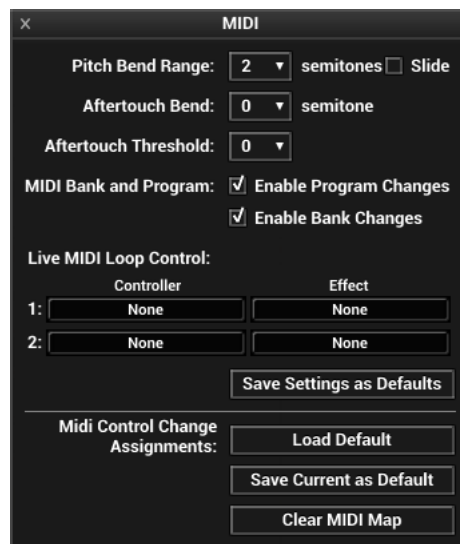

6.2 Tuning

The *Tune* control, located to the right of the MIDI LED, is used to transpose the frequency of the keyboard. This control is composed of two numbers separated by a dot. The first number indicates a value in semi-tones while the second one indicates a value in cents (one hundredth of a semi-tone). The amount of transposition can be adjusted by click-dragging upward or downward on the semi-tone and cent controls. Double clicking on these controls brings back their value to zero. When the value of the *Tune* parameters is set to 0.00, the frequency of notes are calculated relative to A4 440Hz.

6.3 History and Compare

The *History* control allows one to go back through all the modifications that were made to programs since the application was started. In order to travel back and forth in time, use the left and right-pointing arrows respectively and the application will switch between different program states.

The *Compare* button, located above the *Program* display, is used to switch between **Edit** and **Compare** mode. This button is visible only once a modification is applied to a given program. It allows one to revert to the original version of a program in order to compare it with the current version. When in **Compare** mode, edition is blocked and it is therefore not possible to modify any parameter. The **Compare** mode must then be switched *off* by clicking on the *Compare* button in order to resume edition.

6.4 Volume

The *Volume* knob is the master volume of the application. It is used to adjust the overall level of the output signal from the synthesizer. General level is increased by turning the knob clockwise.

6.5 Level Meter

The level meter allows one to monitor peak and RMS (root means square) level of the left (L) and right (R) output channels from the synthesizer. As a limiter is located at the output of *Strum GS*, it is important to make sure that the amplitude of the signal remains within values that ensure that no distortion is introduced in the signal at the output.

The 0 dB mark on the level meter has been adjusted to correspond to -20 dBFS (full scale). This means that at that level, the signal is -20 dB below the maximum allowed value. This 0 dB level mark should typically correspond to playing at mezzo forte (moderately loud) level. This ensures a headroom of 20 dB which should be more than enough to cover the dynamics of most playing situations and therefore guarantee that no additional distortion is added in the output signal.

A peak value mark allows one to follow the maximum level values reached by the output signal. The limiter is triggered when this mark enters the red zone of the level meter (17 dB) and it remains active while the side vertical bars at the top of the level meter are switched *on*.

6.6 The About Box

The **About** box is open by clicking on the chevrons located at the very top of the interface or on the product or company logo. The box is closed by clicking again on the chevrons or outside the box. Useful information is displayed in this box such as the program's version number, the serial number that was used for the authorization and the the email address that was used for registration. The box also includes a link to the pdf version of this manual.

7 Audio and MIDI Settings

This chapter explains how to select and configure Audio and MIDI devices used by *Strum GS*. Audio and MIDI configuration tools are accessed by clicking on the *Audio Setup* button located in the lower left corner of the *Strum GS* interface and the *MIDI* button located just below the MIDI led in upper part of the interface.

Note that in plug-in mode the audio and MIDI inputs, sampling rate, and buffer size are set by the host sequencer.

7.1 Audio Configuration

7.1.1 Selecting an Audio Device

Audio configuration tools are available by clicking on the *Audio Setup* button located in the lower left corner of the *Strum GS* interface. The **Audio Setup** dialog first allows you to select an audio output device from those available on your computer. Multi-channel interfaces will have their outputs listed as stereo pairs.

On Windows, the audio output list is organized by driver type. The device type is first selected from the **Audio Device Type** drop-down list. If you have ASIO drivers available, these should be selected for optimum performance. The *Configure Audio Device* button allows you to open the manufacturer's setup program for your audio interface when available.

Once the audio input has been selected, you can then select a sampling rate and a buffer size from those offered by your audio interface.

7.1.2 Latency

The latency is the time delay between the moment you send a control signal to your computer (for example when you hit a key on your MIDI keyboard) and the moment when you hear the effect. Roughly, the latency is equal to the duration of the buffers used by the application and the sound card to play audio and MIDI. To calculate the total time required to play a buffer, just divide the number of samples per buffer by the sampling frequency. For example, 256 samples played at 48 kHz represent a time of 5.3 ms. Doubling the number of samples and keeping the sampling frequency constant doubles this time while changing the sampling frequency to 96 kHz and keeping the buffer size constant reduces the latency to 2.7 ms.

It is of course desirable to have as little latency as possible. *Strum GS* however requires a certain amount of time to be able to calculate sound samples in a continuous manner. This time depends on the power of your computer, the preset played, the sampling rate, and the number of voices of polyphony used. Note that it literally takes twice as much CPU power to process audio at a sampling rate of 96 kHz as it would to process the same data at 48 kHz, simply because you need to calculate twice as many samples in the same amount of time.

Depending on your machine you should choose, for a given sampling frequency, the smallest buffer size that allows you to keep real-time for a reasonable number of voices of polyphony.

7.2 MIDI Configuration

7.2.1 Selecting a MIDI Device

The list of available MIDI inputs appears at the bottom of the **Audio Setup** dialog. Click on the *Audio Setup* button located in the lower left corner of the *Strum GS* interface and then click on the checkbox corresponding to any of the inputs you wish to use.

7.2.2 Creating MIDI Links

Every control on the *Strum GS* interface can be manipulated by an external MIDI controller through MIDI control change assignments. In most cases this is much more convenient than using the mouse, especially if you want to move many controllers at once. For example, you can map the motion of a knob on the interface to a real knob on a knob box or to the modulation wheel from your keyboard. As you use the specified MIDI controllers, the controls move on the *Strum GS* interface just as if you had used the mouse.

In order to assign a MIDI link to a controller:

- On the *Strum GS* interface, right-click/Control-click on a control (knob, button) and select the **MIDI Learn** command.
- Move a knob or slider on your MIDI controller (this can be a keyboard, a knob box, or any device that sends MIDI). This links the control of *Strum GS* to the MIDI controller you just moved.

To deactivate a MIDI link, simply right-click/Control-click on the corresponding control on the *Strum GS* interface and select the **MIDI Forget** command.

7.2.3 Creating a default MIDI Map

It is possible to define a set of MIDI links, called a MIDI map, that will be loaded automatically when *Strum GS* is launched. Once you have defined a set of MIDI links that you wish to save, click on *MIDI* button to open the *MIDI* configuration window and click on the **Save Current as Default** button.

If you make changes to MIDI links after opening the program and wish to revert to the default MIDI map click on *MIDI* button to open the *MIDI* configuration window and click on the **Load Default** button.

If you wish to deactivate all the MIDI links at once open the *MIDI* configuration window and click on the **Clear MIDI Map** button.

7.2.4 MIDI Program Changes

Strum GS responds to MIDI program changes. When a program change is received, the current program is changed to the program having the same number as that of the program change message in the currently loaded bank.

If you do not wish *Strum GS* to respond to MIDI program changes, open the *MIDI* configuration window by clicking on the *MIDI* button and uncheck the **Enable Program Changes** option.

7.2.5 MIDI Bank Changes

In general, MIDI bank numbers are coded using two signals: the MSB (most significant byte) and LSB (least significant byte) transmitted using MIDI CC (continuous controller) number 0 and 32 respectively. The way these signals are used differs with different manufacturers.

In the case of *Strum GS*, the value of the MSB signal is expected to be zero while the value of the LSB signal represents the bank number. Banks are therefore numbered from 0 to 127 with this number corresponding to the position of a bank within the list of banks as displayed by the Bank manager (see Section 4.3). For example, an LSB value of 0 corresponds to the first bank in the bank list while an LSB value of 10 corresponds to the eleventh bank in the list. Note that a bank change only becomes effective after the reception of a new MIDI program change signal.

If you do not wish *Strum GS* to respond to MIDI bank changes, open the *MIDI* configuration window by clicking on the *MIDI* button and uncheck the **Enable Bank Changes** option.

7.2.6 Pitch bend

The MIDI pitch wheel allows one to vary the pitch of *Strum GS*. The pitch wheel can be moved with the mouse but it is also automatically connected to the pitch wheel signal received from your MIDI keyboard.

The range of the pitch bend is 2 semi-tones up or down by default but can be changed. To adjust the range of the pitch bend, open the MIDI configuration window by clicking on the **MIDI** button located just below the MIDI led in the top part of the interface and use the **Pitch Bend Range** drop-down list to select the range in semi-tones.

7.2.7 Aftertouch

Strum GS responds to aftertouch. By default, the aftertouch signal is linked to pitch bend. To adjust the range of the pitch bend, open the MIDI configuration window by clicking on the **MIDI** button located just below the MIDI led in the top part of the interface and use the **Aftertouch Bend** drop-down list to select the range in semi-tones. Aftertouch can also be used to control any other parameter through the use of MIDI links as described in section 7.2.2. A triggering threshold can also be applied to the aftertouch. This is adjusted using the **Aftertouch Threshold** drop-down list.

The values in the list correspond to values of the aftertouch signal above which aftertouch will be triggered in *Strum GS-2*. When notes are played with aftertouch values below this threshold value, the aftertouch is not triggered. In order to always have aftertouch, set the threshold to a value of zero. Not that the behavior of this parameter may depend on the settings or sensitivity of your MIDI keyboard.

7.2.8 Live MIDI Loop Control

In order to make MIDI loops more expressive, *Strum GS* allows one to link two different MIDI controllers to some performance parameters such as playing softer or louder, slower or faster, increase or decrease the strumming span and putting emphasis on lower or higher strings when strumming. To access this modulation matrix, open the MIDI configuration window by clicking on the **MIDI** button located just below the MIDI led in the top part of the interface and assign effects to controllers in the Live MIDI Loop Control section of the window.

7.2.9 Modulation wheel

Strum GS responds to MIDI modulation (MIDI controller number 1) and controls vibrato by default. For more details, please refer to Section 5.2.2. The modulation wheel can also be used to control any other parameter through the use of MIDI links as described in section 7.2.2.

8 Using *Strum GS* as a Plug-In

Strum GS is available in VST, RTAS, AAX and Audio Units formats and integrates seamlessly into the industry most popular multi-track recording and sequencing environments as a virtual instrument plug-in. *Strum GS* works as any other plug-in in these environments so we recommend that you refer to your sequencer documentation in case you have problems running it as a plug-in. We review here some general points to keep in mind when using a plug-in version of *Strum GS*.

8.1 Audio and MIDI Configuration

When *Strum GS* is used as a plug-in, the audio and MIDI ports, sampling rate, buffer size, and audio format are determined by the host sequencer.

8.2 Automation

Strum GS supports automation functions of host sequencers. All parameters visible on the interface can be automatized except for the **Polyphony**, **Bank**, **Program** and **History** commands.

8.3 Multiple Instances

Multiple instances of *Strum GS* can be launched simultaneously in a host sequencer.

8.4 Saving Projects

When saving a project in a host sequencer, the currently loaded program is saved with the project in order to make sure that the instrument will be in the same state as when you saved the project when you re-open it. Note that banks of programs are not saved with the project which implies that if you are using MIDI program changes in your project, you must make sure that the bank you are using in your project still exists on your disk when you reload the project. The programs must also exist and be in the same order as when the project was saved.

8.5 Performance

Using a plug-in in a host sequencer requires CPU processing for both applications. The load on the CPU is even higher when multiple instances of a plug-in or numerous different plug-ins are used. To decrease CPU usage, remember that you can use the **freeze** or **bounce to track** functions of the host sequencer in order to render to audio the part played by a plug-in instead of recalculating it every time it is played.

9 Appendix - Lists of Chords Detected by *Strum GS*

We present here a list of the main chords recognized by *Strum GS* and for which it can find a guitar voicing. The following guidelines should be kept in mind:

- The chords are presented using C as the root. They can be transposed in any key.
- For all chords, inversions are recognized except if they conflict with another chord from this list.
- Inverted chords on the keyboard do not necessarily have a corresponding voicing on the guitar. In these cases *Strum GS* will still propose a voicing; it is not guaranteed that this voicing will be playable on the guitar and the *no match* sign will be lit in the chord display.
- When chords are played on the keyboard, the order of the notes above the root is not taken into account by *Strum GS*. This implies that you can play the chords as you know them on the keyboard without having to know or learn special voicings used by guitar players.
- Certain guitar voicings do not include all the notes played on the keyboard.
- In addition to the chords listed below, *Strum GS* can recognize other chords for which it has no guitar voicing. In these cases *Strum GS* will still propose a voicing; it is not guaranteed that this voicing will be playable on the guitar and the *no match* sign will be lit in the chord display.

List of Chords recognized and voiced by *Strum GS*

C	Cm	Csus2
Csus4	Caug	Cdim
C(b5)	C6	Cm6
Cm6 (no 5)	C7	C7 (no 3)
C7 (no 5)	Cm7	Cm7 (no 5)
C7sus2	C7sus2 (no 5)	C7sus4
C7sus4 (no 5)	C7#5	Cdim7
C7b5	Cm7b5	CMaj7
CMaj7 (no 3)	CMaj7 (no 5)	CmMaj7

List of Chords recognized and voiced by *Strum GS*

CMaj7sus2	CMaj7sus4	CMaj7b5
Cadd9	C9	C9 (no 5)
Cm9	Cm9 (no 5)	C9sus4
C9sus4 (no 5)	C9#5	C9b5
CMaj9	CMaj9 (no 5)	CmMaj9
CmMaj9 (no 5)	CMaj9b5	C6 9
Cm6 9	Cm6 9 (no 5)	Cm11
Cm11 (no 5)	C13	C13 (no 5)
Cm13	Cm13 (no 5)	C13b9
C13b9 (no 5)	CMaj13	CMaj13 (no 5)
C7b9	C7b9 (no 5)	C7#9
C7#9 (no 5)	C7b5b9	C7b5#9
C7#5b9	C7#5#9	C7#11
Cm7 11	Cm7 11 (no 5)	CMaj7#11
C7b9#11	C7#9#11	C7#9#11 (no 3)
C7 13	C7 13 (no 5)	Cm7 13
Cm7 13 (no 5)	C7b13	CMaj7 13
CMaj7 13 (no 5)	C7b9b13	C7#9b13
C9#11	CMaj9#11	C9b13

List of Chords - Example of a possible position on the keyboard.

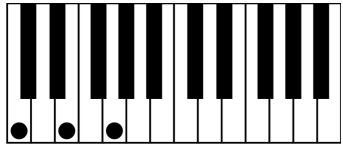

C

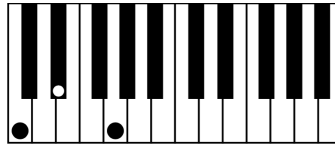

Cm

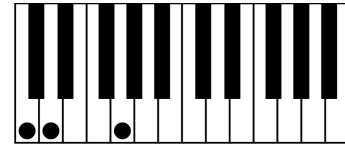

Csus2

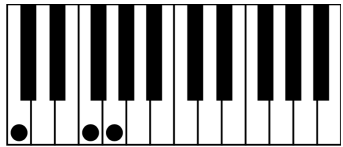

Csus4

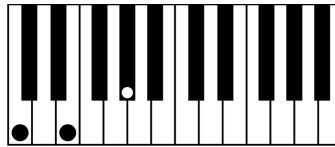

C^{aug}

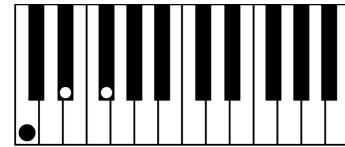

C^{dim}

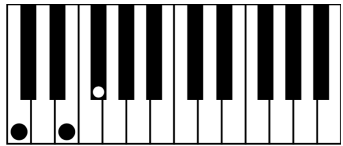

C^(b5)

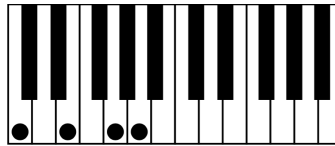

C6

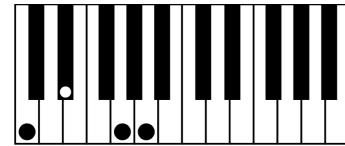

Cm6

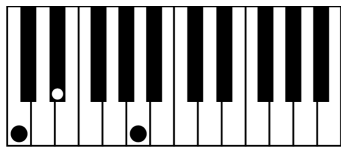

Cm6 (no 5)

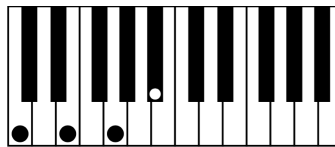

C7

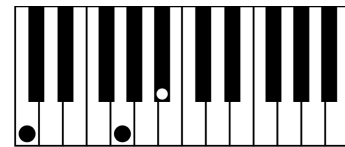

C7 (no 3)

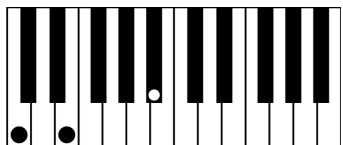

C7 (no 5)

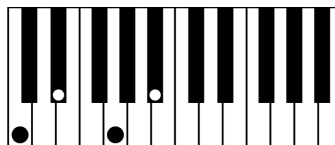

Cm7

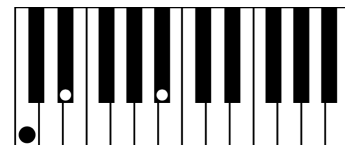

Cm7 (no 5)

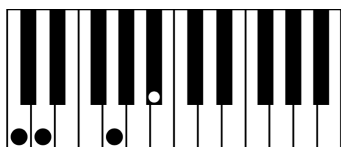

C7sus2

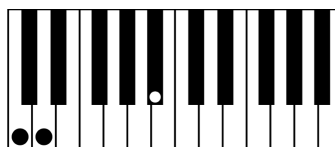

C7sus2 (no 5)

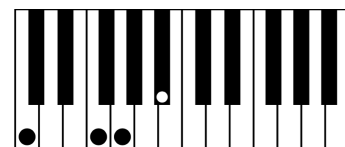

C7sus4

List of Chords - Example of a possible position on the keyboard.

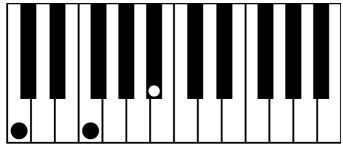

C7sus4 (no 5)

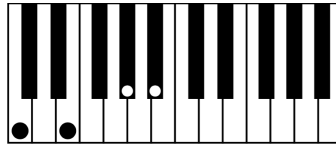

C7#5

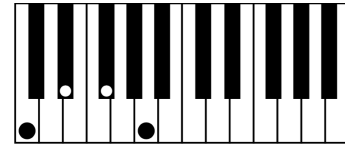

Cdim7

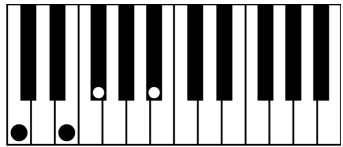

C7b5

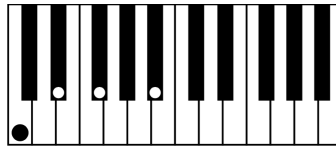

Cm7b5

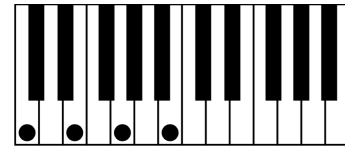

CMaj7

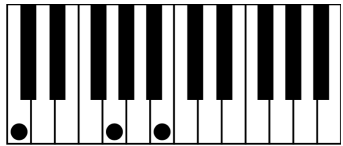

CMaj7 (no 3)

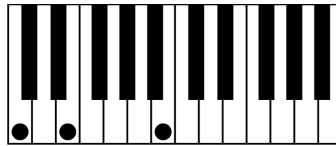

CMaj7 (no 5)

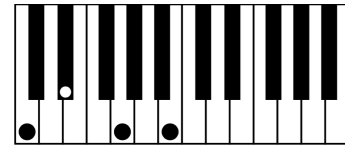

CmMaj7

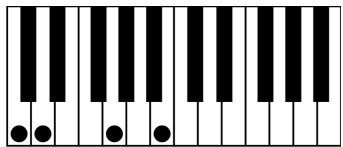

CMaj7sus2

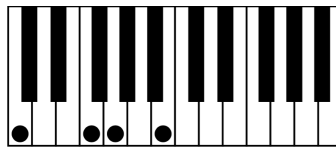

CMaj7sus4

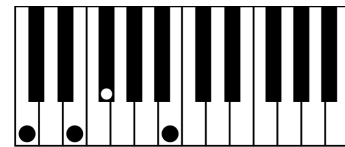

CMaj7b5

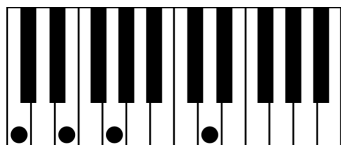

Cadd9

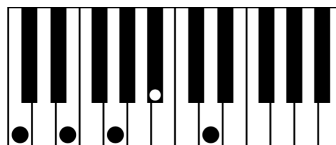

C9

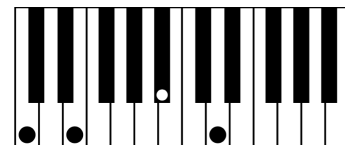

C9 (no 5)

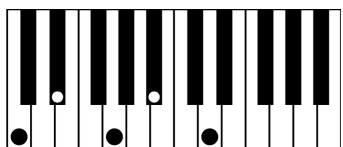

Cm9

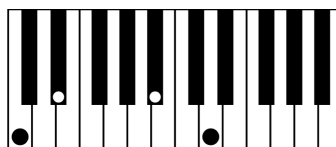

Cm9 (no 5)

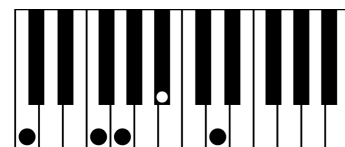

C9sus4

List of Chords - Example of a possible position on the keyboard.

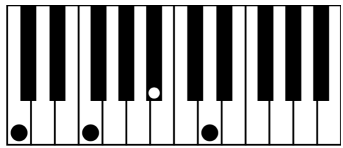

C9sus4 (no 5)

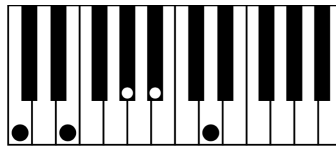

C9#5

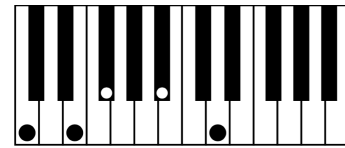

C9b5

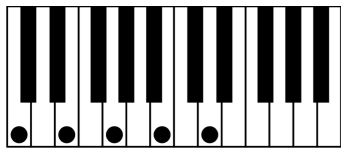

CMaj9

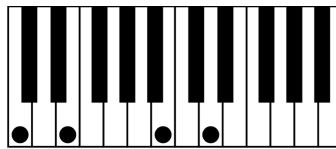

CMaj9 (no 5)

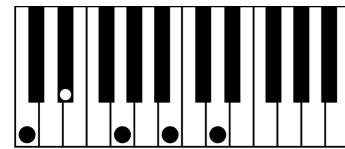

CmMaj9

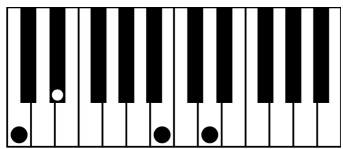

CmMaj9 (no 5)

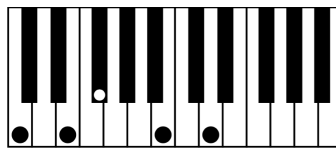

CMaj9b5

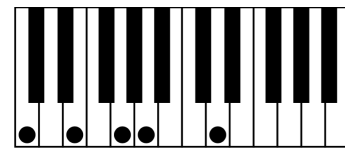

C6 9

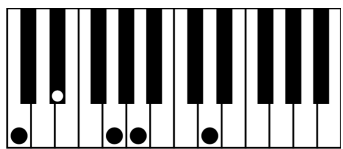

Cm6 9

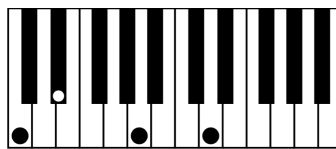

Cm6 9 (no 5)

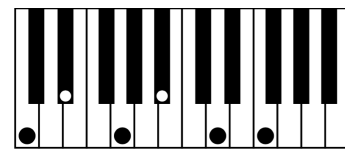

Cm11

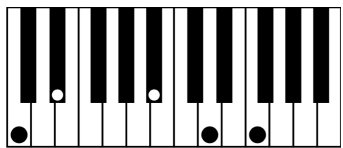

Cm11 (no 5)

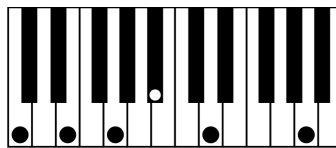

C13

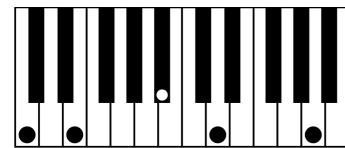

C13 (no 5)

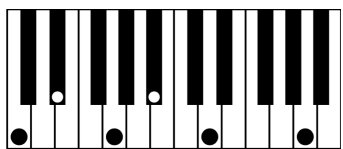

Cm13

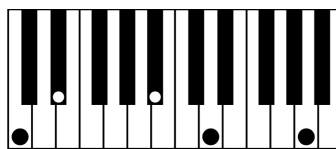

Cm13 (no 5)

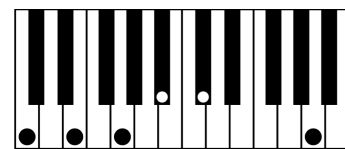

C13b9

List of Chords - Example of a possible position on the keyboard.

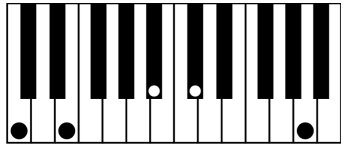

C13b9 (no 5)

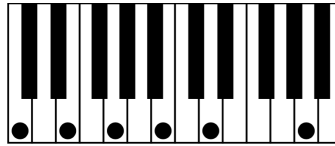

CMaj13

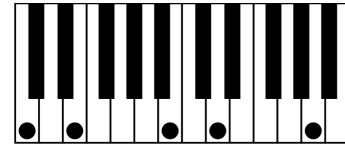

CMaj13 (no 5)

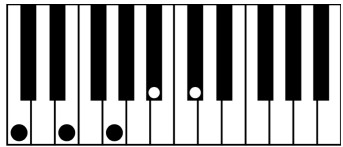

C7b9

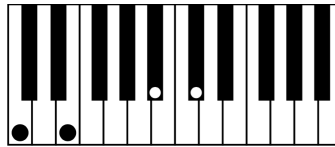

C7b9 (no 5)

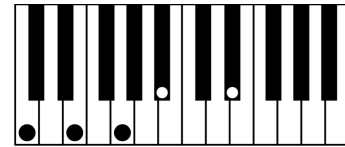

C7#9

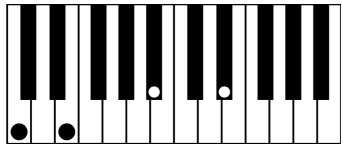

C7#9 (no 5)

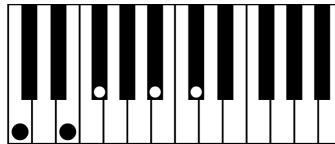

C7b5b9

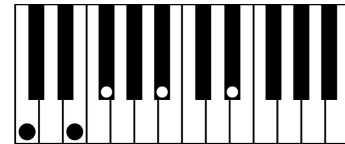

C7b5#9

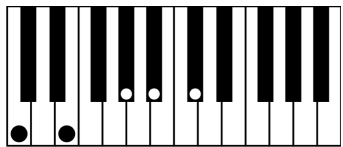

C7#5b9

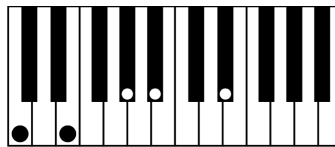

C7#5#9

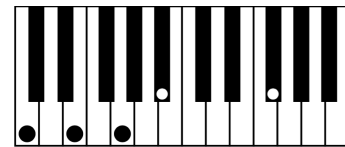

C7#11

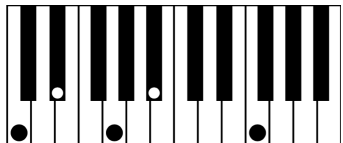

Cm7 11

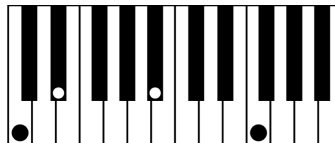

Cm7 11 (no 5)



CMaj7#11

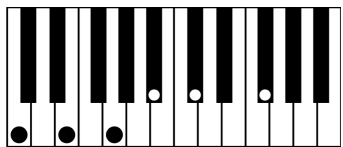

C7b9#11

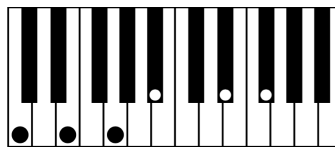

C7#9#11

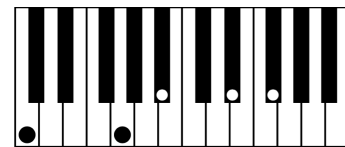

C7#9#11 (no 3)

List of Chords - Example of a possible position on the keyboard.

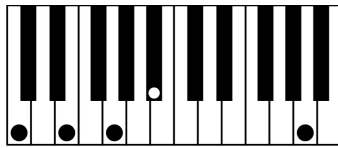

C7 13

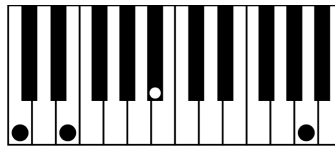

C7 13 (no 5)

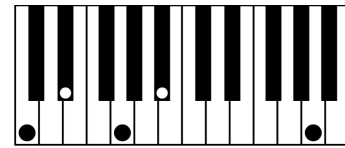

Cm7 13

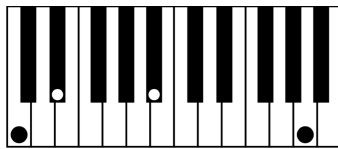

Cm7 13 (no 5)

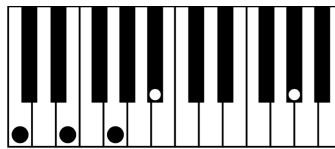

C7^b13

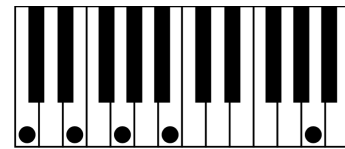

CMaj7 13

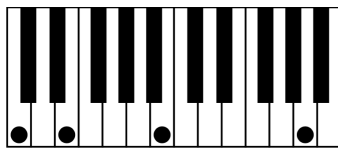

CMaj7 13 (no 5)

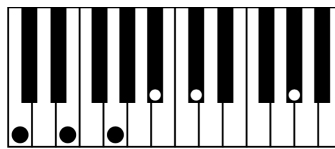

C7^b9^b13

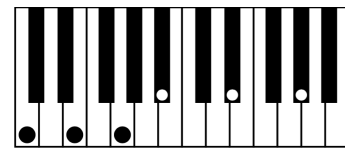

C7[#]9^b13

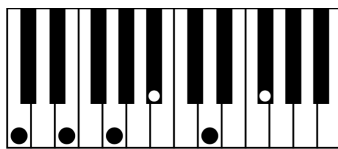

C9[#]11

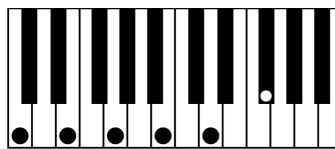

CMaj9[#]11

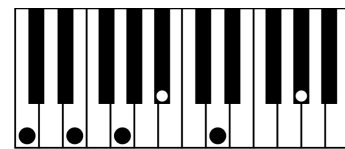

C9^b13

10 License Agreement

IMPORTANT! CAREFULLY READ ALL THE TERMS AND CONDITIONS OF THIS AGREEMENT BEFORE OPENING THIS PACKAGE. OPENING THIS PACKAGE INDICATES YOUR ACCEPTANCE OF THESE TERMS AND CONDITIONS. IF YOU DO NOT AGREE WITH THE TERMS AND CONDITIONS OF THIS AGREEMENT, PROMPTLY RETURN THE UNOPENED PACKAGE AND ALL COMPONENTS THERETO TO THE PARTY FROM WHOM IT WAS ACQUIRED, FOR A FULL REFUND OF ANY CONSIDERATION PAID.

This software program, any printed materials, any on-line or electronic documentation, and any and all copies of such software program and materials (the “**Software**”) are the copyrighted work of Applied Acoustics Systems DVM Inc. (“**AAS**”), its subsidiaries, licensors and/or its suppliers.

1. **LICENSE TO USE.** The Licensee is granted a personal, non-exclusive and non-transferable license to install and to use one copy of the Software on a single computer solely for the personal use of the Licensee. Use of the Software is subject to this Agreement.
2. **RESTRICTIONS ON USE.** The Licensee may not nor permit third parties to (i) make copies of any portion of the Software, other than as expressly permitted under this Agreement; (ii) modify, translate, disassemble, decompile, reverse engineer or create derivative and/or competitive products based on any portion of the Software; (iii) provide use of the Software in a network, timesharing, interactive cable television, multiple CPU service bureau or multiple user arrangement to users not individually licensed by AAS, other than as expressly permitted by the terms of this license. The Software is licensed to you as a single product. Its component parts may not be separated for use on more than one computer.
3. **OWNERSHIP.** AAS retains title to the Software, including but not limited to any titles, computer code, themes, objects dialog concepts, artwork, animations, sounds, audio effects, methods of operation, moral rights, any related documentation and “applets” incorporated into the Software. AAS retains ownership of and title to all intellectual property rights in the Software, underlying technology, related written materials, logos, names and other support materials furnished either with the Software or as a result of this Agreement, including but not limited to trade secrets, patents, trademarks and copyrights therein. Licensee shall not remove or alter any copyright or other proprietary rights notices contained on or within the Software and shall reproduce such notices on all copies thereof permitted under this Agreement or associated documentation.
4. **LIMITED WARRANTY.** Except for the foregoing, THE SOFTWARE IS provided “AS IS” without warranty or condition of any kind. AAS disclaims all warranties or conditions, written or oral, statutory, express or implied, including but not limited to the implied warranties of merchantable quality or fitness for a particular purpose, title and non-infringement of rights of any other person. AAS does not warrant that THE SOFTWARE will meet the Licensee’s requirements or that the operation of the software will be uninterrupted or ERROR-FREE.

5. **LIMITATION OF LIABILITY.** TO THE MAXIMUM EXTENT PERMITTED BY APPLICABLE LAW, IN NO EVENT WILL AAS BE LIABLE TO THE LICENSEE OR ANY THIRD PARTY FOR ANY INDIRECT, SPECIAL, CONSEQUENTIAL, INCIDENTAL OR EXEMPLARY DAMAGES WHATSOEVER, INCLUDING BUT NOT LIMITED TO LOSS OF REVENUE OR PROFIT, LOST OR DAMAGED DATA, BUSINESS INTERRUPTION OR ANY OTHER PECUNIARY LOSS WHETHER BASED IN CONTRACT, TORT OR OTHER CAUSE OF ACTION, EVEN IF AAS HAS BEEN ADVISED OF THE POSSIBILITY OF SUCH DAMAGES, EXCEPT IN RELATION TO GROSS NEGLIGENCE OR WILFUL BREACH OF THIS AGREEMENT BY AAS. NO AAS AGENT, REPRESENTATIVE OR DEALER IS AUTHORIZED TO EXTEND, MODIFY OR ADD TO THIS WARRANTY ON BEHALF OF AAS. THE TOTAL LIABILITY OF AAS FOR DAMAGES, WHETHER IN CONTRACT OR TORT, UNDER OR RELATED IN ANY WAY TO THIS AGREEMENT SHALL BE LIMITED TO THE LICENSE FEES ACTUALLY PAID BY LICENSEE TO AAS, OR IF NO FEES WERE PAID, AAS' LIST PRICE FOR THE SOFTWARE COVERED BY THIS LICENSE. THE EXCLUSION OF IMPLIED WARRANTIES AND/OR THE LIMITATION OF LIABILITY IS NOT PERMITTED IN SOME JURISDICTIONS, AND SOME OR ALL OF THESE EXCLUSIONS MAY THEREFORE NOT APPLY.
6. **TERMINATION.** This License also shall extend to the Software and any updates or new releases thereof obtained by the Licensee, if any, subject to any changes to this License made by AAS from time to time and provided to the Licensee, provided AAS is under a separate obligation to provide to Licensee such updates or upgrades and Licensee continues to have a valid license which is in effect at the time of receipt of each such update or new release. This License shall remain in effect until terminated. The Licensee may terminate this Agreement at any time, upon notification to AAS. This Agreement will terminate immediately without notice from AAS if the Licensee fails to comply with any provision of this License. Any such termination by AAS shall be in addition to and without prejudice to such rights and remedies as may be available, including injunction and other equitable remedies. Upon receipt of notice of termination from AAS, the Licensee must (a) immediately cease to use the Software; (b) destroy all copies of the Software, as well as copies of all documentation, specifications and magnetic media relating thereto in Licensee's possession or control; and (c) return all original versions of the Software and associated documentation. The provisions of Sections 1, 3, and 5 shall survive the termination of this Agreement.
7. **GOVERNING LAW.** This Agreement shall be governed by and construed in accordance with the laws of the Province of Quebec, without regard to the United Nations Convention On Contracts for the International Sale of Goods and conflict of laws provisions, if applicable, and the parties hereby irrevocably attorn to the jurisdiction of the courts of that province. Les parties sont d'accord à ce que cette convention soit rédigée en langue anglaise. The parties have agreed that this agreement be drafted in the English language.
8. **SEVERABILITY.** If any of the above provisions are held to be illegal, invalid or unenforceable, such provision shall be severed from this Agreement and this Agreement shall not be

rendered inoperative but the remaining provisions shall continue in full force and effect.

9. ENTIRE AGREEMENT. This Agreement is the entire agreement between AAS and the Licensee relating to the Software and: (i) supersedes all prior or contemporaneous oral or written communications, proposals and representations with respect to its subject matter; and (ii) prevails over any conflicting or additional terms of any quote, order, acknowledgement, or similar communication between the parties during the term of this Agreement except as otherwise expressly agreed by the parties. No modification to the Agreement will be binding, unless in writing and signed by a duly authorized representative of each party.
10. NON-WAIVER. No delay or failure to take any action or exercise any rights under this Agreement shall constitute a waiver or consent unless expressly waived or consented to in writing by a duly authorized representative of AAS. A waiver of any event does not apply to any other event, even if in relation to the same subject-matter.

Index

- about, 65
- aftertouch, 31, 68
- alternate bass, 22
- amplifier, 51
- architecture, 11
- arp keys, 22
- arpeggios, 22, 28
- audio, 66
 - configuration, 9, 66
 - device, 66
 - latency, 66
- auto-strum, 12, 22, 39
- auto-wah, 16, 47, 59
- automatic chords, 19

- backup, 34
- bank, 32
 - backup, 34
 - create, 32
 - delete, 32
 - factory library, 35
 - rename, 32
 - sharing, 34
- bank manager, 32
- bass and chords, 30
- bend, 30
- body, 46
- buffer size, 9, 66

- cabinet, 51
- chords
 - change, 23
 - change of pitch, 24
 - detection, 11
 - detection time, 40
 - display, 39
 - drop, 26
 - list, 71
 - lowest, 26
 - movable, 26
 - open, 26
 - root, 26
 - type, 40
 - voicing, 26
- chorus, 16, 47, 53
 - mono, 53
 - stereo, 53
- clock, 37, 39
- coarse, 36
- compare, 64
- compressor, 16, 47, 49
- contact, 10

- default MIDI map, 67
- delay, 16, 47, 52
- distortion, 51, 53, 64
- downstroke, 20
- drop chords, 26
- drop-down menus, 36

- edit view, 15, 42
- effect
 - master clock, 39
 - synchronization, 37
- effects view, 16, 47
- EQ, 16, 48
- equalizer, 16, 47

- factory library, 9
- fine tuning, 36
- fingers, 43
- flanger, 16, 47, 55

- guitar mode, 11, 18, 38

- hammer-on, 18, 45
- help, 9, 10
- history, 64

- individual strings, 22
- installation, 8

- inteface
 - resize, 14
- interface, 14, 36
 - drop-down menus, 36
 - knobs, 36
 - numerical displays, 36
 - switches, 36
- keyboard, 14, 41
- keyboard mode, 11, 18, 38
- knobs, 36
- latency, 66
- level meter, 64
- library
 - restore, 35
- limiter, 64
- loop, 11
 - control, 25, 69
 - creating, 25, 26
 - expressivity, 25, 69
 - modulation, 25, 69
 - using, 24
- loop mode, 24, 38
- loops module, 40
- manual, 65
- master clock, 39
- master volume, 64
- MIDI, 66
 - aftertouch, 68
 - bank change, 68
 - configuration, 9, 67
 - device, 67
 - link map, 67
 - links, 67
 - loop control, 25, 69
 - loop player, 40
 - pitch bend, 38, 68
 - program change, 32, 34, 68
 - receiving, 63
- MIDI controller, 67
- MIDI led, 63
- minimum system requirements, 7
- modulation, 36
- modulation wheel, 14, 38
- modules, 36
- movable chords, 26
- muffled strokes, 21
- multi-effect, 16, 47
 - auto wah, 59
 - chorus, 53
 - delay, 52
 - distortion, 53
 - EQ, 48
 - flanger, 55
 - notch filter, 59
 - phaser, 57
 - reverb, 60
 - synchronization, 37
 - wah wah, 59
- mute, 45
- mute all, 21
- muted strum, 29
- no 3, 39
- no 5, 39
- no match, 39
- notch filter, 16, 47, 59
- numerical displays, 36
- open chords, 26
- overdrive, 53
- overview, 11
- palm, 46
- palm muting, 21
- parameters, 36
- partial strumming, 29
- peak, 64
- phaser, 16, 47, 57
- pick, 43
- picking, 22
- pickups, 38, 47
 - bridge, 47
 - cutoff, 47

- humbucker, 47
- neck, 47
- position, 47
- resonance, 47
- single coil, 47
- trim, 47
- pitch bend, 14, 68
- pitch wheel, 31, 38
- play mode, 38
- play view, 14, 37
- playing mode, 11
- plug-in, 10
 - audio configuration, 70
 - automation, 70
 - formats, 70
 - MIDI configuration, 70
 - multiple instances, 70
 - performance, 70
 - saving projects, 70
- polyphony, 8
- powerchords, 27
- programs, 9, 32
 - backup, 34
 - bank manager, 32
 - copy, 32
 - factory library, 35
 - move, 32
 - saving, 32
 - sharing, 34
- pull-off, 18, 45
- range, 39
- resize, 14
- restore factory library, 35
- reverb, 16, 60
- ribbon, 14
- sampling rate, 8, 9
- save, 32
- save as, 32
- sc, 49
- side chain, 49
- signal flow, 11, 12
- solid state, 53
- speaker, 51
- spring reverb, 51
- standalone, 9
- start-up, 9
- stationary bend, 30
- strings, 42
- strum down, 23
- strum range, 39
- strumming, 12, 39
 - auto, 39
 - keys, 39
- strumming keys, 12, 18, 19, 22
- sustain pedal, 23
- switches, 36
- synchronization, 37, 39
- synchronization to a host, 39
- system requirements, 7
- transpose, 64
- tremolo, 47
- trills, 29
- tuning, 64
- upstroke, 20
- utility section, 63
- vibrato, 14, 38
- vintage chorus, 53
- voicing, 11
- volume, 64
- VU meter, 64
- wah wah, 16, 47, 59
- warm tube, 53