

P143

Quantum LED Apex Master
IN3058SL
User Manual

InFocus



Google TV

What's in the box

When opening the packaging, check the contents of the box against the list below. If there is anything missing, please contact the seller in due time.

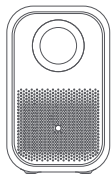

Smart Projector

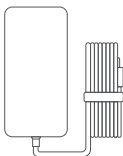

Adapter



Power Cord



Remote Control



User Manual



Warranty Card



Note:

- The actual contents may vary depending on the country (or region) of sale, please refer to the actual product.
- Retain the original packaging for future storage or transportation.

Getting Started

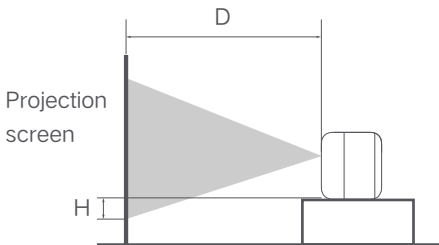
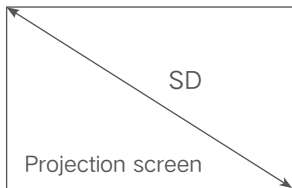

Determine the distance between the projector and the wall or screen according to the desired screen size.

Screen Dimensions (SD)	Relative Distance (D)	Relative Height (H)
40"	110	8.5
60"	165	21
80"	219	33.5
100"	274	46
120"	330	58

Screen Dimensions (SD): The diagonal size of the projection screen (in inches).

Relative Distance (D): The distance between the projector and the wall or screen (in cm).

Relative Height (H): The distance from the bottom of the projector to the bottom edge of the projected image (in cm).



Note:

The dimensions in the table above are for reference only, they are approximate and may slightly differ from the actual values.

Power up

Connect your power cable to the projector, then plug it in to the wall outlet. Power your projector remote by inserting the appropriate batteries. (batteries not included)

Connect other devices by referencing port label and descriptions on the next page.

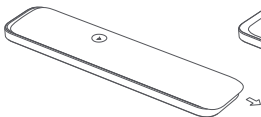

Step 1. Push the back cover in the direction of the arrow, and after hearing a sound, the back cover will separate from the remote control.

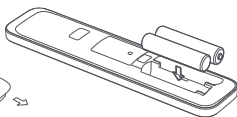

Step 2. Remove the back cover, then take out the battery.

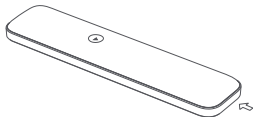

Step 3. Install the battery, then put the back cover onto the remote control and push it firmly in the direction of the arrow until it clicks into place. Once you hear a sound, it indicates that it has been installed properly.















Note:

- Pay attention to the positive and negative poles when installing batteries in the remote control.
- When battery leaks, immediately wipe away any fluid with a dry cloth and replace the batteries with new ones.
- Dispose of used batteries according to local waste disposal rules and regulations of the country or area you live in.

Grab your remote R605B



-  POWER: Turn Projector on and off
-  PROFILE SELECTOR :
Switch between different Google Accounts
-  SETTINGS: Access the settings
-  GOOGLE ASSISTANT:
Press the Google Assistant button on your remote to talk to Google Assistant
-  NAVIGATION PAD:
Move up, down, left, or right, then press the middle button to confirm
-  BACK: Return to previous screen
-  HOME: Return to home screen
-  Referring to the instructions below
 1. If Live Tab is supported in country then launch Live Tab.
 2. If device supports tuner then launch deep link to OEM app.
- Volume Button:
 -  + Increase the volume
 -  - Decrease the volume
-  Netflix: Access the Netflix App
-  YouTube: Access the YouTube App

Product Overview

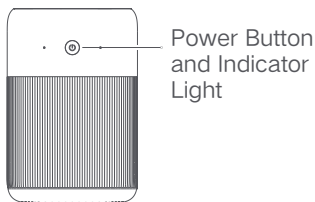
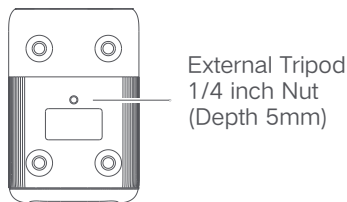
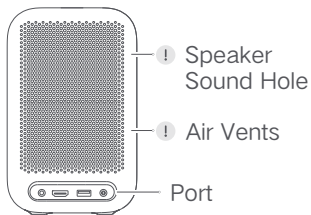
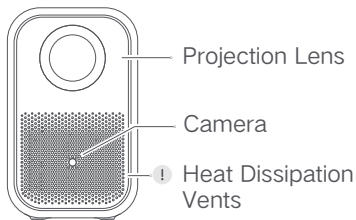

CAUTION:

- Do not place objects within 20cm near the heat dissipation vents.
- Do not place any objects near the vents, as this may cause heat to build up inside the projector.
- Do not look directly into the lens so as to avoid eye damage as this projector emits strong light during use.

Connection Ports

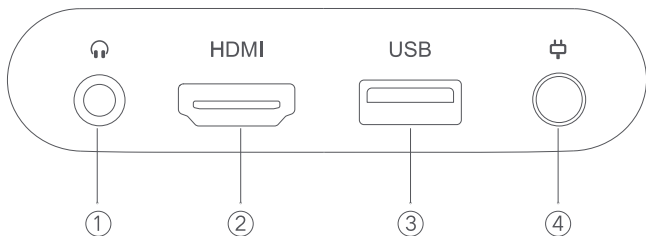

- ① Line Out:
Connect an analog cable to an external analog audio system.
- ② HDMI:
Highest quality audio/video connection. Connect cable box, Blu-ray player, gaming console, or other devices to your projector using HDMI cables.
- ③ USB:
Connect a USB device to access photos, music and movies.
- ④ DC:
Connect your projector to the power source with the included power cable.

Power Indicator

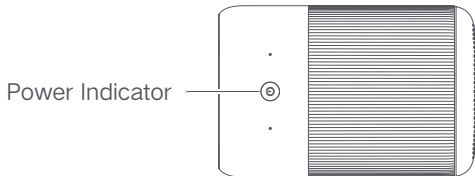

Press the power button on the body and the power button on the remote control to turn it on and off.

The power indicator (a soft white light) to the corresponding projector's status is as follows:

- During the startup process, the indicator light is always on and then blinks breathingly, and then goes out after entering the main interface of the system.
- After entering the system, the indicator light is always off.
- After entering the shutdown screen, the indicator light is always on.
- When the system is in standby, the indicator light is off.
- The breathing light is always on during the shutdown process, and the breathing light is off after the shutdown.

Keystones & Focus

1. Move the projector, the screen will be omni-directional automatic correction and auto-focus.
2. Open the settings menu, find Projector in Settings, here you can choose Keystone Correction or Focus to realize the function.

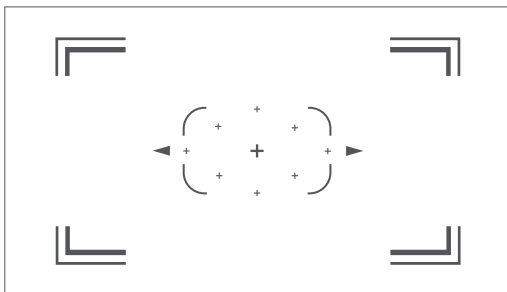

Hoisting instructions

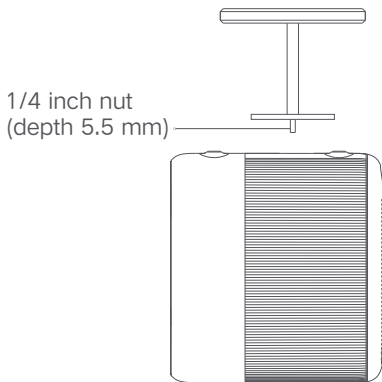

Note:

- For hoisting, please use screws of specified specifications and select a suitable bracket.

Specifications

Basic Information	Name	Quantum LED Apex Master
	Model	P143
	Item Dimensions	207*190*127 mm
	Input	2.07 kg
Electrical Specifications	Total Power	≤100W
	Standby Power	< 0.5W
	Input	DC19V \approx 6.32A
Optical Parameters	Resolution	1920*1080
	Ratio	1.25:1
	Ratio	40~120"
	Focus	Auto Focus
	Keystone Correction	Omni-directional auto-keystone correction
System	Storage	2G DDR/16G eMMC
	System	Google TV
	Bluetooth	BT 5.0
	Wireless	Wi-Fi IEEE 802.11 a/b/g/n/ac 2.4GHz/5GHz
Audio	Audio Effects	Dolby Audio
	Speaker	2 × 5W Full-range

Others	Noise	$\leq 30\text{dB}$ viewing mode @ ambient temperature of 25°C
	Storage Temperature/ Humidity	-20°C to 55°C / $\leq 90\%$
	Operating Temperature/ Humidity	0°C to 40°C / $20\% - 80\%$

Troubleshooting

Fault	Solution
No projected image	Turn off the projector and disconnect from the power, then plug in the power cord and turn on the projector.
Android system crashes	Turn off the projector and disconnect from the power, then plug in the power cord and turn on the projector.
Screen display error	Turn off the projector and disconnect from the power, then plug in the power cord and turn on the projector.

Fault	Solution
Remote control is missing or not paired and the projector cannot be turned on remotely.	Turn off the projector and disconnect from the power. Wait for five minutes, then plug in the power cord and turn on the projector. After the projector has been restarted, pair the remote control again.
If the projector overheats, it will automatically turn off.	Please remove any obstacles from the air inlets and outlets so as to ensure a smooth airflow through the projector. Follow the instructions above to restart the projector.
Other Internal System Errors	Please contact a qualified technician to service the device, or return the projector to the after-sales department.

Regulatory Compliance



Hereby, Maxnerva Technology Services Ltd declares that the radio equipment type [LCD Smart Projector / XMM2101] is in compliance with Directive 2014 / 53 / EU and Radio Equipment Regulations 2017. The full text of the declaration of conformity is available at the following internet address:

docs.infocus.com

This device is restricted to indoor use when operating in the 5150 to 5350 MHz frequency range.

BT maximum transmitter power: 100mW at 2.4GHz - 2.4835GHz

Wi-Fi 2.4G maximum transmitter power: 100mW at 2.4GHz - 2.4835GHz

Wi-Fi 5G maximum transmitter power: 200mW at 5.15GHz - 5.25GHz, 100mW at 5.25GHz - 5.35GHz & 5.47GHz - 5.725GHz

The product complies with "RG1 IEC/EN 62471-5 : 2015".



All products bearing this symbol are waste electrical and electronic equipment (WEEE as in directive 2012/19/EU) which should not be mixed with unsorted household waste. Instead, you should protect human health and the environment by handing over your waste equipment to a designated collection point for the recycling of waste electrical and electronic equipment, appointed by the government or local authorities. Correct disposal and recycling will help prevent potential negative consequences to the environment and human health. Please contact the installer or local authorities for more information about the location as well as terms and conditions of such collection points.



Correct disposal of the batteries in this product (Applicable in countries with separate collection systems) This marking on battery, manual or packaging indicates that the batteries in this product should not be disposed of with other household waste at the end of their working life. Where marked, the chemical symbols Hg, Cd or Pb indicate that the battery contains mercury, cadmium or lead above the reference levels in EC Directive 2006/66. If batteries are not properly disposed of, these substances can cause harm to human health or the environment. To protect natural resources and to promote material reuse, please separate batteries from other types of waste and recycle them through your local, free battery return system.



This device complies with part 15 of the FCC Rules. Operation is subject to the following two conditions: (1) This device may not cause harmful interference, and (2) this device must accept any interference received,

including interference that may cause undesired operation.

Note: This equipment has been tested and found to comply with the limits for a Class B digital device, pursuant to part 15 of the FCC rules. These limits are designed to provide reasonable protection against harmful interference in a residential installation. This equipment generates, uses and can radiate radio frequency energy and, if not installed and used in accordance with the instructions, may cause harmful interference to radio communications. However, there is no guarantee that interference will not occur in a particular installation. If this equipment does cause harmful interference to radio or television reception, which can be determined by turning the equipment off and on, the user is encouraged to try to correct the interference by one or more of the following measures:

- Reorient or relocate the receiving antenna.
- Increase the separation between the equipment and receiver.
- Connect the equipment into an outlet on a circuit different from that to which the receiver is connected.
- Consult the dealer or an experienced radio/TV technician for help.

Important: You are cautioned that changes or modifications not expressly approved by the party responsible for compliance could void the user's authority to operate the equipment.

RF Exposure Information: The radiated output power of this device meets the limits of FCC/IC radio frequency exposure limits. This device should be operated with a minimum separation distance of 20cm (8 inches) between the equipment and a person's body.

Canada regulatory compliance

This device complies with Innovation, Science and Economic Development Canada license-exempt RSS standard(s). Operation is subject to the following two conditions: (1) this device may not cause interference, and (2) this device must accept any interference, including interference that may cause undesired operation of the device.

Operation in the band 5150–5250 MHz is only for indoor use to reduce the potential for harmful interference to co-channel mobile satellite systems.

Exposure to radio frequency energy

The radiated output power of this device meets the limits of FCC/IC radio frequency exposure limits. This device should be operated with a minimum separation distance of 20 cm (8 inches) between the equipment and a person's body.

CAN ICES-003 (B)/NMB-003(B)

Le présent appareil est conforme aux CNR d'Innovation, Sciences et Développement économique Canada applicables aux appareils radio exempts de licence. L'exploitation est autorisée aux deux conditions suivantes : (1) l'appareil ne doit pas produire de brouillage, et (2) l'utilisateur de l'appareil doit accepter tout brouillage radioélectrique subi, même si le brouillage est susceptible d'en compromettre le fonctionnement.

La bande 5150–5250 MHz est réservée uniquement pour une utilisation à l'intérieur afin de réduire les risques de brouillage préjudiciable aux systèmes de satellites mobiles utilisant les mêmes canaux.

L'exposition à l'énergie radiofréquence

La puissance de sortie rayonné de cet appareil est conforme aux limites de la FCC/IC limites d'exposition aux fréquences radio. Cet appareil doit être utilisé avec une distance minimale de séparation de 20 cm entre l'appareil et le corps d'une personne.

CAN ICES-003 (B)/NMB-003(B)



CAUTION:

- Risk of explosion if the battery is replaced by an incorrect type.
- Disposal of a battery into fire or a hot oven, or mechanically crushing or cutting of a battery, that can result in an explosion.
- Leaving a battery in an extremely high temperature surrounding environment that can result in an explosion or the leakage of flammable liquid or gas.
- A battery subjected to extremely low air pressure that may result in an explosion or the leakage of flammable liquid or gas.

Product Certifications

Powered by

Boston Acoustics®

 **Dolby Audio**

Manufactured under license from Dolby Laboratories. Dolby, Dolby Audio, and the double-D symbol are trademarks of Dolby Laboratories Licensing Corporation.

HDMI™

HIGH-DEFINITION MULTIMEDIA INTERFACE

The terms HDMI, HDMI High-Definition Multimedia Interface, and the HDMI Logo are trademarks or registered trademarks of HDMI Licensing Administrator, Inc.

 **Bluetooth®**



Google TV is the name of this device's software experience and a trademark of Google LLC. Google and YouTube are trademarks of Google LLC.

Google Assistant is not available in all languages and countries. Availability of services varies by country and language.

The product marking and safety information are located at the bottom of the product.

EU IMPORTER:

GRAND FIELD TECHNOLOGY LIMITED,
1001, 10/F HOUSTON CENTRE, 63 MODY ROAD, TSIM SHA TSUI EAST
KOWLOON, HONG KONG

EU REPRESENTATIVE:: 24 HOUR AR,

VAN NELLEWEG 1, 3044 BC ROTTERDAM, THE NETHERLANDS
+31 (0)10 321 2116 / WWW.24HOUR-AR.COM /
INFO@24HOUR-AR.COM

UK REPRESENTATIVE: 24 HOUR AR,

15 BEAUFORT COURT,ADMIRALS WAY,CANARY WHARF,LONDON E14 9XL,
ENGLAND
+44 (0)20 457 129 06 / WWW.24HOUR-AR.COM /
INFO@24HOUR-AR.COM

US IMPORTER:

MAXNERVA TECHNOLOGY SERVICES US LLC
13190 SW 68TH PKWY SUITE 120, PORTLAND, 97223, USA

Maxnerva has appointed AUVIX LLC,
129085, c. Moscow, Zvezdny Boulevard, 21, bldg. 1. as the authorised
representative in Russia and this product is compliant with
TR TC 004/2011, TR TC 020/2011 and TR CU020/2011 local conformity testing
and approvals.

Maxnerva назначил ООО « АУВИКС »,
129085, г. Москва, Звездный бульвар, д. 21, стр. 1., в качестве
официального представителя в России, и этот продукт соответствует
требованиям

TR TC 004/2011, TR TC020/2011 и TR CU 020 /2011г. местные испытания на
соответствие и согласования.

ООО « АУВИКС »

129085, г. Москва, Звездный бульвар, д. 21, стр. 1

+7 (495) 797-57-75

info@auvix.ru