

**MACALLY**

**LAMPCHARGAC**

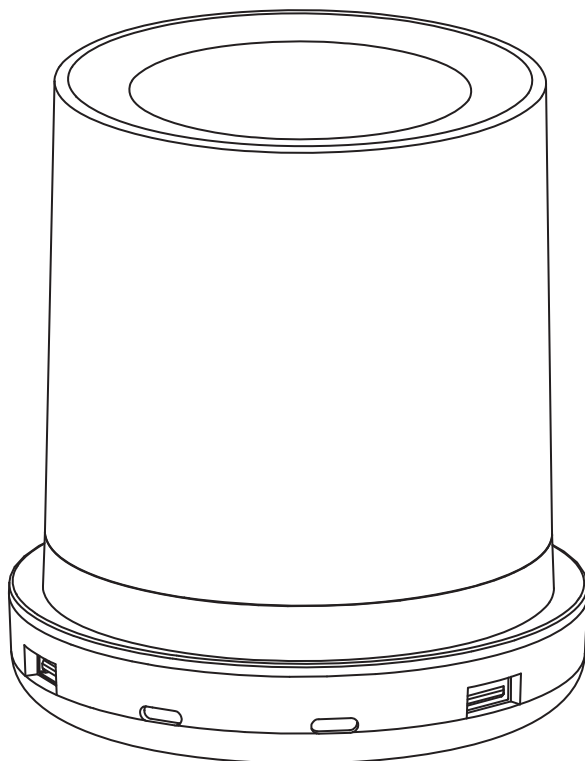

## **Touch Lamp with (USB A + C) Charging**

# MACALLY

Welcome to the Macally family and thank you for purchasing the LAMPCHARGAC.

Our mission is to deliver aesthetically pleasing, high-quality and affordable peripherals and accessories to satisfied customers. We do that by creating products that are both innovative and practical but most important easy-to-use.

If you have any questions, feedback, or just want to say hi, please reach out to us at [techsupport@macally.com](mailto:techsupport@macally.com) or on any one of our social media channels.

Don't forget to share your setup with us using [#macally](https://twitter.com/macally) and follow us for to get exclusive offers.



**MacallyUSA**



With Love From Southern California,  
Macally

# PACKAGE CONTENTS

- LAMPCHARGAC
- Power Cable
- User's Guide

# HARDWARE BASICS

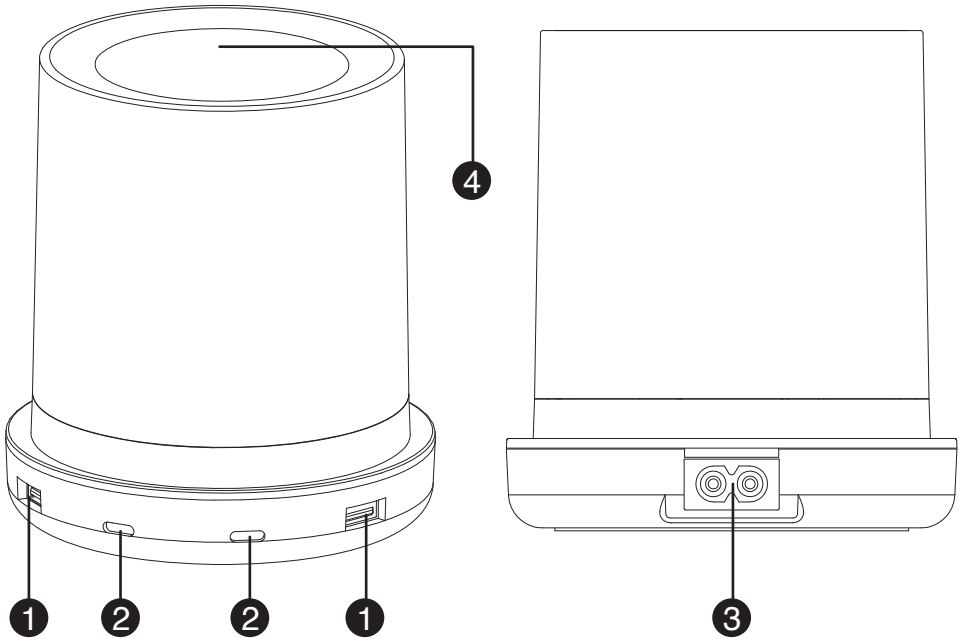

1. USB-A Ports
2. USB-C Ports
3. Input for the power cable
4. Touch sensor

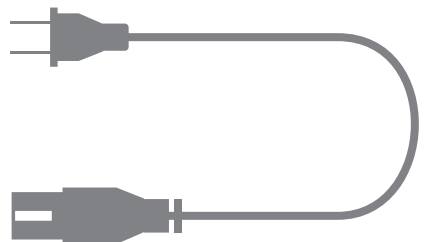

## SET UP

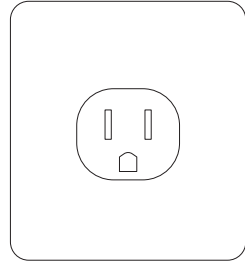
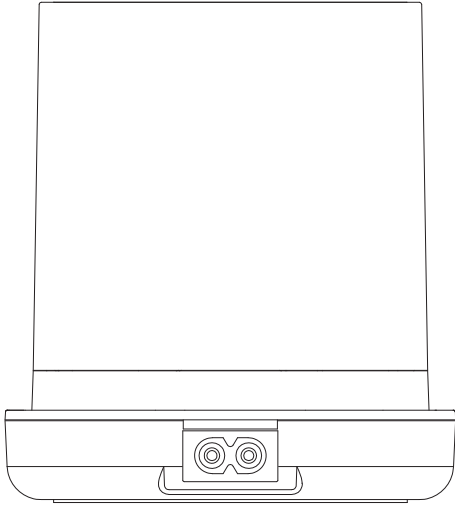

Connect the power cable to the input of the LAMPCHARGAC. After that, plug the other end of the power cable into either a wall outlet or a power strip.

# CHARGING YOUR DEVICES

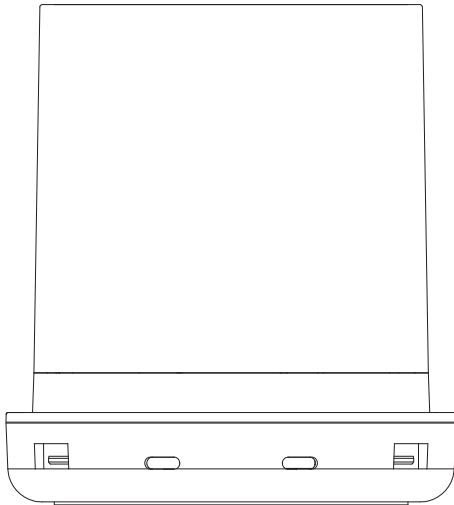

## CHARGING OUTPUT

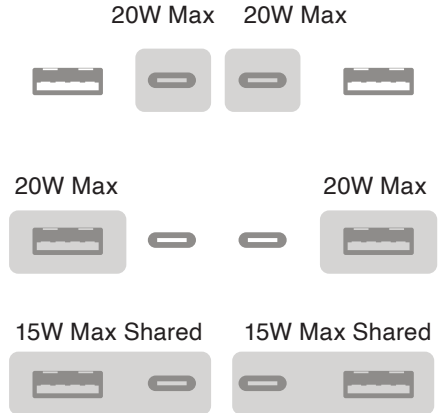

You can charge your devices by plugging your charging cable into either USB-A or USB-C ports.

### **NOTE**

*Each port delivers up to 20W (15W when shared) to safely charge your devices. Shared output is determined when 2 devices are simultaneously being charged on either half of the lamp charger.*

# CONTROLLING THE LIGHT

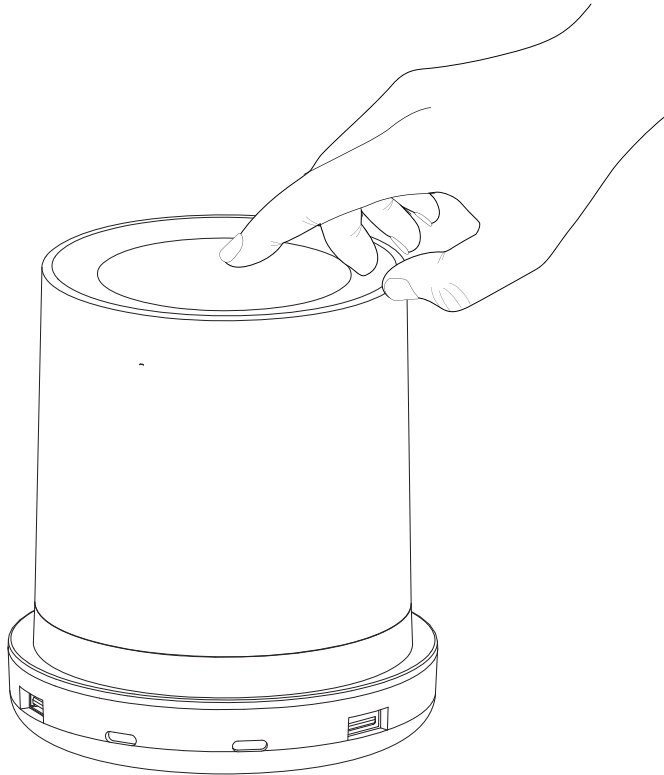

To control the light simply tap the top of the LAMPCHARGAC.

- Tap 1: Dim
  - Tap 2: Brighter
  - Tap 3: Brightest
- Tap and hold to turn it off

# SAFETY INSTRUCTIONS

Please read the following carefully. Incorrect use of this product may result in reduced performance, permanent damage and void your warranty.

- Keep this device away from liquid, humidity and moisture.
- Operate this device only within the specific temperature range of 0°C (32° F) to 5°C to 40°C(104° F)
- Please refrain from taking the device apart. Doing so will void your warranty.
- Do not dispose this product in the garbage. Take it to your local recycling center.

# SPECIFICATIONS

Input	120 V ~ 60Hz
Type C output	5V – 3A, 9V – 2.2A, 12V – 1.66A
Type A Output	5V – 3A, 9V – 2.2A, 12V – 1.66A
Type C + USB A Output	5V – 3A Max
LED Lamp Output	2.0W Max

# TECH SUPPORT

Tech support hours are from 9:00 AM to 5:00 PM Monday through Friday (PST).

- E-Mail: [techsupport@macally.com](mailto:techsupport@macally.com)
- Phone: (909) 230-6888

## **FCC STATEMENT**

*This device complies with part 15 of the FCC Rules. Operation is subject to the following two conditions: (1) This device may not cause harmful interference, and (2) this device must accept any interference received, including interference that may cause undesired operation.*

*Any Changes or modifications not expressly approved by the party responsible for compliance could void the user's authority to operate the equipment.*

**Note:** *This equipment has been tested and found to comply with the limits for a Class B digital device, pursuant to part 15 of the FCC Rules. These limits are designed to provide reasonable protection against harmful interference in a residential installation. This equipment generates uses and can radiate radio frequency energy and, if not installed and used in accordance with the instructions, may cause harmful interference to radio communications. However, there is no guarantee that interference will not occur in a particular installation. If this equipment does cause harmful interference to radio or television reception, which can be determined by turning the equipment off and on, the user is encouraged to try to correct the interference by one or more of the following measures: .*

- Reorient or relocate the receiving antenna.*
- Increase the separation between the equipment and receiver.*
- Connect the equipment into an outlet on a circuit different from that to which the receiver is connected.*
- Consult the dealer or an experienced radio/TV technician for help.*

*The device has been evaluated to meet general RF exposure requirement. The device can be used in portable exposure condition without restriction.*

## **Warranty**

*Macally Peripherals warrants that this product will be free from defects in title, materials and manufacturing workmanship for one year in North America from the date of the purchase. If the product is found to be defective then, as your sole remedy and as the manufacturer's only obligation, Macally will repair or replace the product. This warranty is exclusive and is limited to the product that this user's guide came with. This warranty shall not apply to products that have been subjected to abuse, misuse, abnormal electrical or environmental conditions, or any condition other than what can be considered normal use. The liability of Macally Peripherals arising from this warranty and sale shall be limited to a refund of the purchase price. In no event shall Macally Peripherals be liable for costs of procurement of substitute products or services, or for any lost profits, or for any consequential, incidental, direct or indirect damages, however caused and on any theory of liability, arising from this warranty and sale. These limitations shall apply notwithstanding any failure of essential purpose of any limited remedy.*