

RB20 4K Dual-Lens PTZ VideoBar

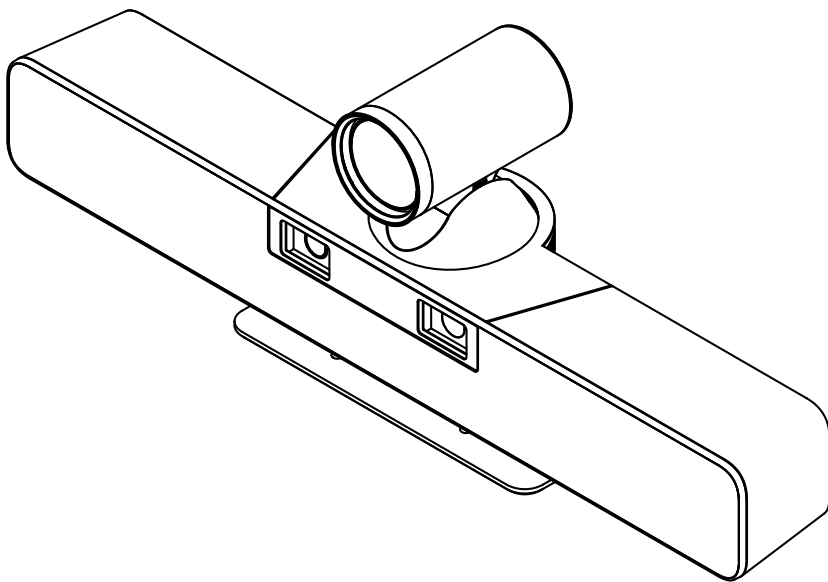

User Manual

Limitation of Liability

This manual does not contain any warranties or implied warranties of any kind. The contents of this manual may be updated at any time without notice.



Operating this equipment in a residential environment may cause radio interference.

FCC Regulatory Conformance:



This device complies with Part 15 of the FCC Rules. The operation is subject to the following two conditions: (1) this device may not cause harmful interference, and (2) this device must accept any interference received, including interference that may cause undesired operation.



This equipment has been tested and found to comply with the limits for a Class A digital device, pursuant to Part 15 of the FCC Rules. These limits are designed to provide reasonable protection against harmful interference in a residential installation. This equipment generates uses and can radiate radio frequency energy and, if not installed and used by the instructions, may cause harmful interference to radio communications. However, there is no guarantee that interference will not occur in a particular installation. If this equipment does cause harmful interference to radio or television reception, which can be determined by turning the equipment off and on, the user is encouraged to try to correct the interference by one or more of the following measures:

- Reorient or relocate the receiving antenna.
- Increase the separation between the equipment and the receiver.
- Connect the equipment into an outlet on a circuit different from that to which the receiver is connected.
- Consult the dealer or an experienced radio/television technician for help.



The manufacturer is not responsible for any radio or TV interference caused by unauthorized modifications to this equipment. Such modifications could void the user's authority to operate the equipment.

Changes or modifications not expressly approved by the party responsible for compliance could void the user's authority to operate the equipment.

RF Exposure

This equipment complies with FCC radiation exposure limits set forth for an uncontrolled environment. This equipment should be installed and operated with minimum distance of 20 cm between the radiator and your body. This transmitter must not be co-located or operating in conjunction with any other antenna or transmitter.

EU Regulatory Conformance

RF exposure information: The Maximum Permissible Exposure (MPE) level has been calculated based on a distance of 20cm between the device and the human body. To maintain compliance with RF exposure requirement, use product that maintain a 20cm distance between the device and human body.



Hereby, we declare that the radio equipment is in compliance with Directive 2014/53/EU.

5G

The 5150 to 5350 MHz frequency range is restricted to indoor use only in: AT, BE, BG, CH, CY,CZ, DE, DK, EE, EL, ES, FI, FR, HR, HU, IE, IS, IT, LI, LT, LU, LV, MT, NL, NO, PL, PT, RO, SE, SI, SK, TR, UK.

Operation temperature: 0~40°C

Operation frequency (Max power): 2.402-2.480GHz

Bluetooth: 2402-2480 (9dBm)

Wi-Fi:

2412MHz-2472MHz(18dBm)

5180MHz-5240MHz(21dBm)

5745MHz-5850MHz(11dBm)

Catalogue

1	Safety Precautions.....	1
2	Packing List	1
3	Connection	2
4	About Product.....	3
4.1	Features	3
4.2	Appearance	5
4.3	Dimension	6
4.4	Installation	7
4.4.1	TV Mounting (Optional)	7
4.4.2	Wall Mounting	8
4.5	Remote Control.....	9
5	AI Tracking.....	10
5.1	Presenter Tracking.....	10
5.2	Speaker Framing	13
5.3	Group Framing	14
5.4	Smart Gallery	15
6	BYOM.....	16
7	GUI Menu	17
7.1	MENU	17
7.2	CLOSE-UP VIDEO SETTING.....	17
7.2.1	EXPOSURE	17
7.2.2	COLOR.....	17
7.2.3	IMAGE.....	18
7.2.4	NOISE REDUCTION	18
7.2.5	P/T/Z Setting.....	18
7.3	Panorama VIDEO SETTING.....	18
7.3.1	EXPOSURE	18
7.3.2	COLOR.....	19
7.3.3	IMAGE.....	19
7.3.4	NOISE REDUCTION	19
7.4	AUDIO SETTING	19
7.5	AI SETTING	20
7.6	GENERAL SETTING	20
7.7	INFORMATION.....	21

7.8	RESTORE DEFAULT	21
8	WEB Settings	22
8.1	Access Camera.....	22
8.2	Control Camera.....	22
8.3	Live (Closeup).....	23
8.3.1	Exposure.....	23
8.3.2	Color	24
8.3.3	Image	24
8.3.4	Display	24
8.4	Live (Pano).....	25
8.4.1	Exposure.....	25
8.4.2	Color	25
8.4.3	Image	25
8.4.4	Display	26
8.5	AI	26
8.5.1	Settings.....	26
8.5.2	Calibration.....	26
8.6	Network	26
8.6.1	Lan	26
8.6.2	WIFI	27
8.7	System	27
8.7.1	Initialize	27
8.7.2	User.....	27
8.7.3	Log	27
8.8	Information	27
8.8.1	Information	27
8.8.2	System Upgrade.....	28
9	Troubleshooting	28

1 Safety Precautions

- During the installation and operation, all electrical safety regulations of the country and region of use must be strictly observed.
- Please use the 12V 5A power adapter that comes standard with this product.
- Do not connect multiple devices to the same power adapter (exceeding the capacity of the adapter may generate excessive heat or cause fire).
- Do not rotate the camera by hand, otherwise it may cause mechanical failure.
- When installing this product on a wall or ceiling, make sure the device is secure and there are no obstacles within the rotation range. Do not power on until all installations are completed.
- To avoid heat build-up, please keep smooth ventilation around the device.
- If the device smokes, smells, or makes noises, please turn off the power and unplug the power cord immediately, then contact the dealer in time.
- This device is not waterproof, please keep the device dry.
- This product has no user-serviceable parts, damage caused by the user's disassembly is not covered by the warranty.



Running this device in a residential environment may cause radio interference.

2 Packing List

Name	Quantity
VideoBar (With Base)	1
Power Adapter	1
Remote Control	1
USB Cable	1
Wall Mount Bracket (with screws)	1
Quick Start Guide	1

3 Connection

The cable connection contains optional configurations and for reference only. Please connect the cables according to actual needs.

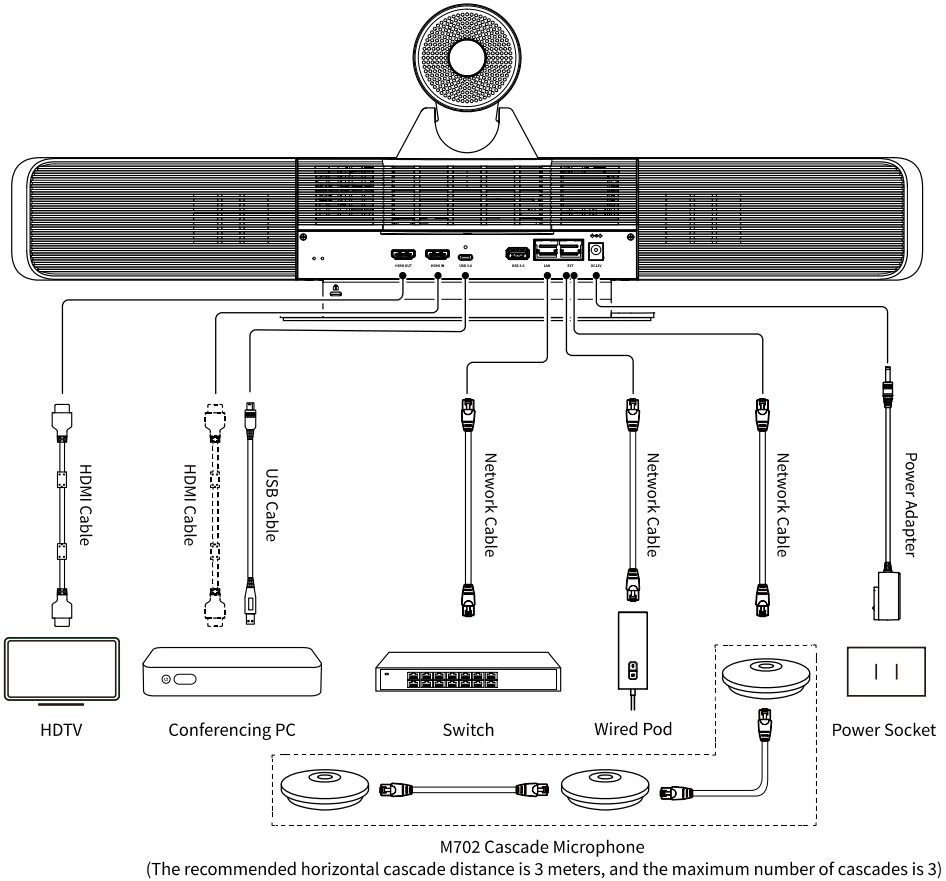

Note

When the device needs to switch between peripheral mode and BYOM mode, connect the HDMI OUT of the Conference PC to the HDMI IN interface of the Camera. If only using peripheral mode, please ignore this connection.

Instructions for BY42 Wired Pod:

Connect to Host

- Connect one end of the network cable to the LAN port of the Pod and the other end to the EXT port of the Host;

- Or, connect one end of a network cable to the UP port of the Cascade Microphone and the other end to the EXT port of the Host; Connect one end of another network cable to the DOWN port of the Cascade Microphone and the other end to the LAN port of the Pod.

Connect to PC

- Connect the USB-C (DP-IN) cable of the Pod to the USB Type-C port (support DP Alt Mode) on the PC;
- Or, connect the USB-C/USB-A cable of the Pod to the USB Type-C port (not support DP Alt Mode) or USB Type-A port on the PC, and connect one end of the HDMI cable to the HDMI IN port of the Pod and the
- other end to the HDMI OUT port on the PC.

Pairing

When the connections are complete and the devices are powered on, the Wired Pod will automatically search for and pair with the Host (indicated by a blue flashing indicator). When pairing is successful and an input source is detected, the sharing button will light solid red.

Screen Sharing

Press the sharing button to start screen-sharing, the sharing indicator will light with solid blue. Press the sharing button again to stop screen-sharing, the sharing indicator will switch to red.

4 About Product

4.1 Features

- **Applicable Scenarios**

Designed specifically for medium and large meeting rooms, with a dual-camera integrated design, easy deployment and maintenance, creating a smart, comfortable, and efficient remote communication environment for business negotiations and team collaboration.

- **Customer Value**

Innovative high-magnification optical zoom gimbal camera delivers exceptional image quality; Integrates leading AI scene detection and AI audio algorithms to significantly improve meeting efficiency; Supports external devices and BYOM dual modes, enhancing the flexibility and compatibility of remote collaboration and reducing the maintenance costs.

- **Integrated Design**

Close-up and panorama dual-lens, array microphones, and dual-channel speakers all integrated into one compact design, featuring minimal wiring for quick and easy deployment and maintenance.

- **Dual-lens Collaborative Shooting**

The panorama camera is equipped with a 120° ultra-wide-angle lens, providing a comprehensive view of the entire venue. Real-time AI detection and analysis ensure zero omissions. The close-up camera is equipped with a high-performance mechanical gimbal and a 12x optical zoom lens, delivering lossless close-up shots of participants, and providing a more accurate and intelligent meeting experience.

- **4K UHD**

Both close-up and panorama cameras are equipped with high-quality UHD CMOS sensors, supporting smooth 4K30 video output and delivering exceptional image quality.

- **Integrated Mechanical Pan-Tilt**

The close-up camera is equipped with a high-precision silent electric pan-tilt unit, with a horizontal rotation range of $\pm 90^\circ$ and a vertical rotation range of $\pm 23^\circ$, providing comprehensive coverage of the entire meeting space and accurately capturing meeting details.

- **Presenter Tracking**

Equipped with AI algorithms such as ReFace, ReID and gesture recognition, supports recognition to lock onto the presenter. When the presenter moves, the camera seamlessly follows and captures them, making the meeting experience with dynamic visuals.

- **Group Framing**

Equipped with AI algorithm for frame selection, it can identify the number of participants and changes in their positions, automatically adjusting the PTZ of the camera to obtain the best composition, ensuring that all participants are in the frame.

- **Speaker Framing**

Equipped with high-precision AI algorithms for sound source localization, support sound localization and links with the close-up camera to automatically present clear close-up images of one or more presenters, ensuring that the active speaker is always in focus.

- **Smart Gallery**

Equipped with AI algorithms for facial and human recognition, automatically presents close-up images of multiple participants, dynamically adjusting the screen layout to ensure that every participant can engage equally in the meeting and experience the immediacy of face-to-face communication.

- **Wired and Wireless BYOM**

With wired and wireless BYOM Pod, participants can share their screens with a single click from their personal laptops. They can also use the device's camera, microphone, and speakers, and join any cloud meeting software to enjoy a professional-grade audio and video collaboration experience.

- **Dual-mode Automatic Switching**

Equipped with an HDMI IN interface, support smart detection and automatic seamless switching between peripheral mode and BYOM mode, adapting to a wider range of meeting scenarios.

- **8-meter Pickup Range**

Built-in 6 MEMS microphone arrays, low-distortion beamforming algorithm accurately captures the presenter, ensuring clear and natural voice quality with an effective pickup range of up to 8 meters.

- **Expanded Audio Pickup**

Equipped with a PSE-powered multi-purpose expansion interface, supporting the cascading of three M702 array microphones to cover larger meeting spaces.

- **Stereo Amplification**

Built-in full-range stereo speaker system with 8+8W high-power output, professional acoustic structure design, delivering clear, rich, and authentic sound reproduction.

- **Intelligent Audio Algorithm**

Equipped with intelligent audio 3A algorithm (AEC/AGC/ANS) with deep learning capabilities, effectively eliminates environmental noise, reverberation, and background noise in meeting rooms, suppresses echoes, and ensures consistent voice clarity regardless of distance in the venue, providing a high-quality full-duplex communication experience.

- **Privacy and Security Protection**

The close-up camera supports automatic privacy mode and can link the privacy cover of the panorama camera to open and close to protect the security of the meeting space information.

- **Easy Deployment**

Offers multiple installation options, including desktop placement, wall mounting, and TV/display mounting, Supports USB plug-and-play, making device deployment flexible and easy.

4.2 Appearance

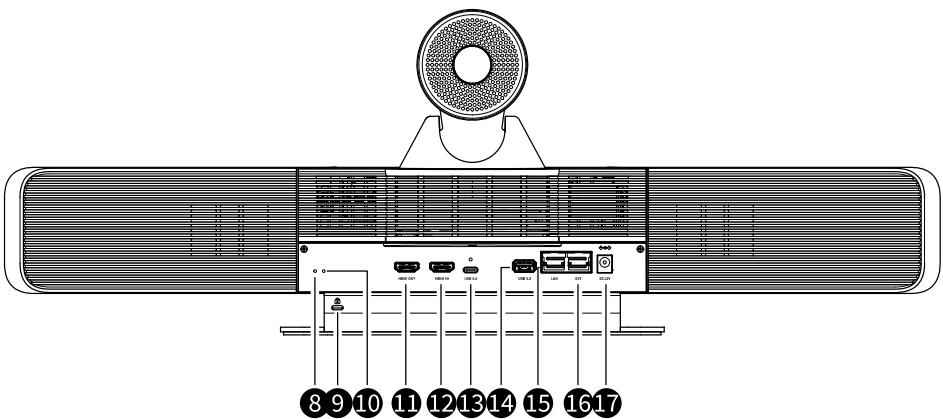
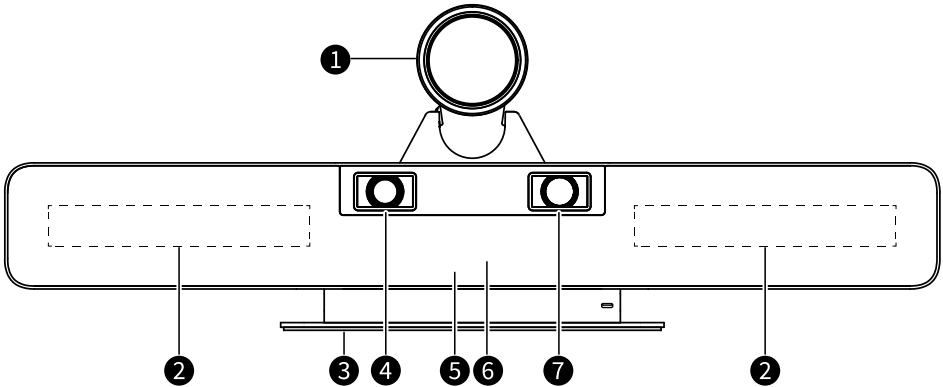

No.	Name	No.	Name
1	Close-up Camera	10	Burning Port
2	Loudspeaker	11	HDMI OUT Interface
3	Base	12	HDMI IN Interface
4	Panorama Camera	13	USB 3.0 Type-C Interface
5	Microphone	14	USB 3.0 Type-A Interface
6	Status Indicator	15	LAN Interface
7	IR Window	16	EXT Interface
8	Reset Port	17	DC 12V Interface
9	Security Lock	-	-

4.3 Dimension

Unit: mm

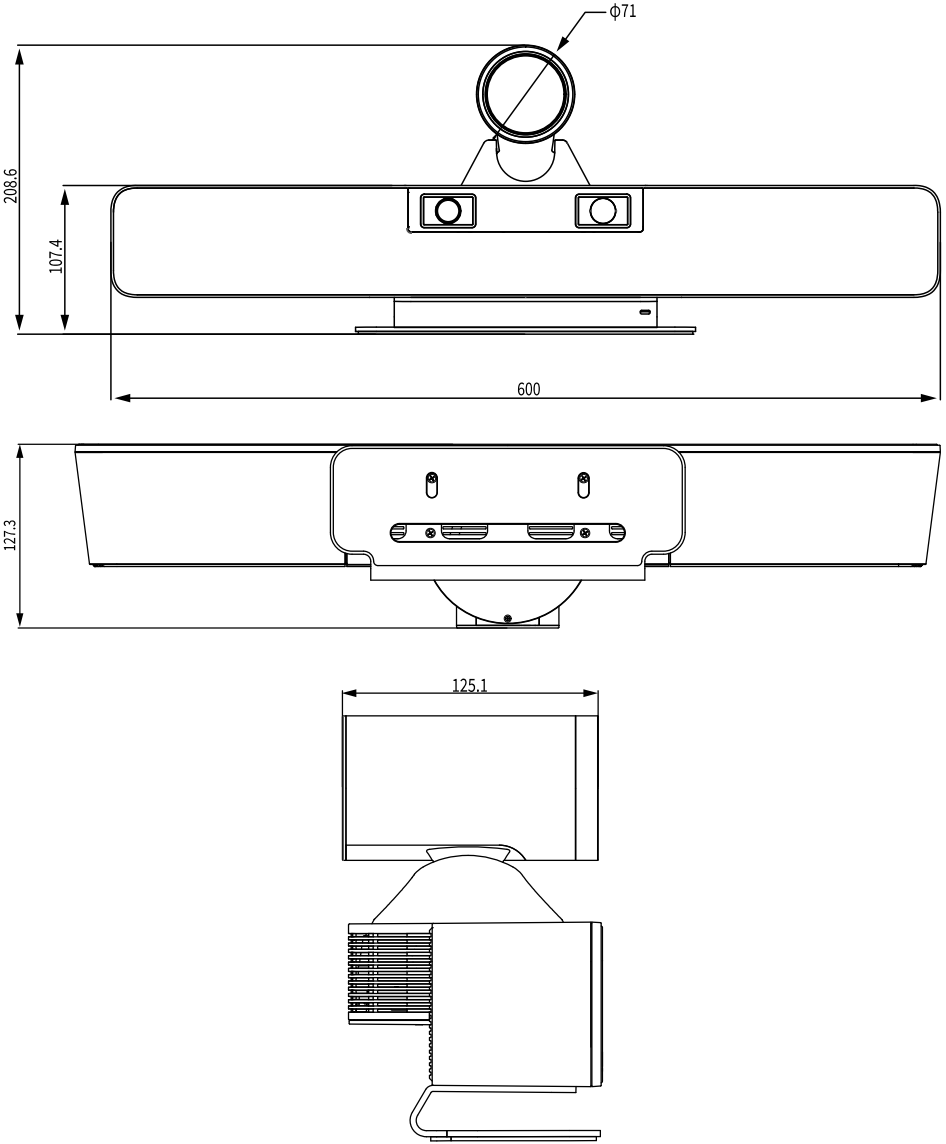

4.4 Installation

4.4.1 TV Mounting (Optional)

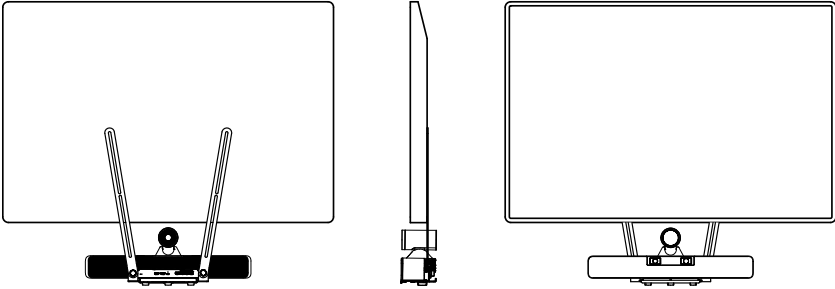

Bottom Installation

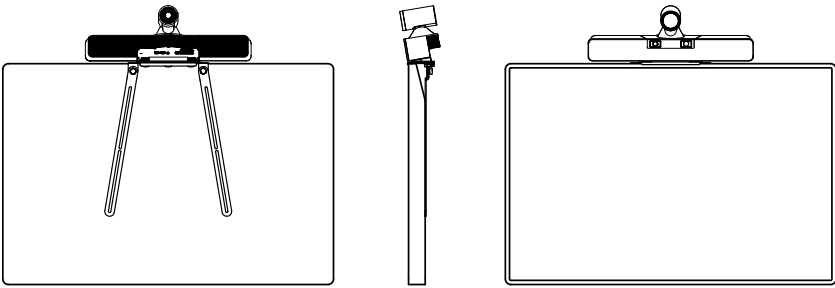

Top Installation

4.4.2 Wall Mounting

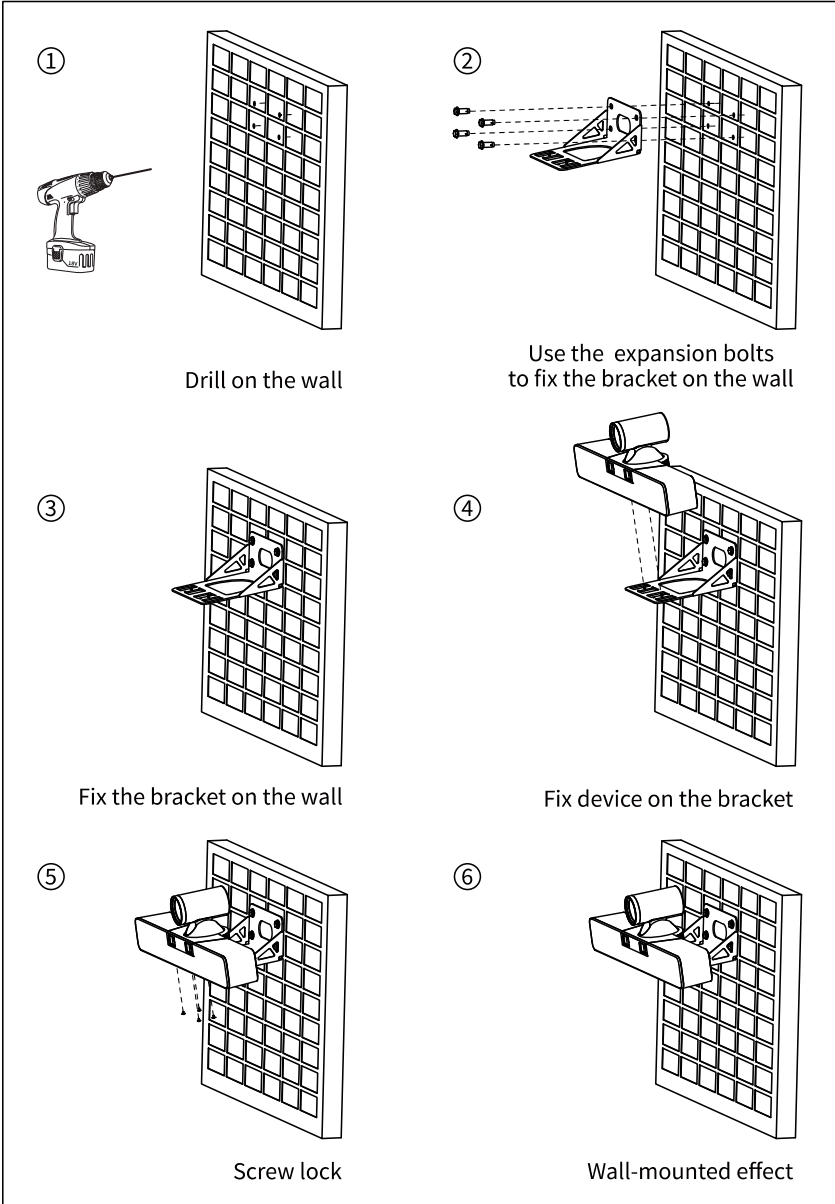

The installation diagram is for reference only. Please refer to the actual product for installation accessories.

4.5 Remote Control

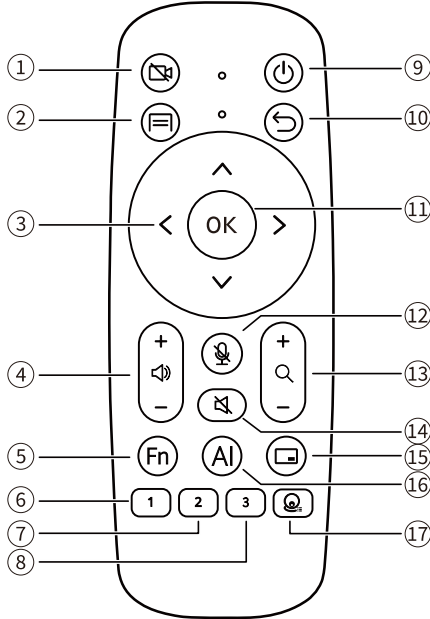

Key Description
1. Privacy Cover Switch
<ul style="list-style-type: none"> When closing the video: The privacy cover of the panoramic camera closed, and the close-up camera turned to the privacy position When opening the video: The privacy cover of the panoramic camera opened, and the close-up camera returned to the previous position
2. Menu Key
Enter/Exit the OSD menu
3. Direction Keys
<ul style="list-style-type: none"> Menu mode: Select and set the menu Non menu mode: Turn the close-up camera to Up/Down/Left/Right direction
4. Volume +/- Keys
Press to increase or decrease the volume
5. Fn Key (Custom Function Key)
Reserved, supported after future software upgrades
6. Preset 1 Key
Press to call preset 1
7. Preset 2 Key
Press to call preset 2

8. Preset 3 Key
Press to call preset 3
9. Standby Key
Enter/Exit the standby mode
10. Return Key
<ul style="list-style-type: none"> Menu mode: Return to the previous menu Tracking mode: Exit the tracking mode
11. OK Key
Confirm selection
12. Microphone Mute Key
Turn On/Off the Microphone
13. Zoom Keys
Zoom in [+]; Zoom out [-]
14. Speaker Mute Key
Turn On/Off the Speaker
15. Layout Switch Key
Press repeatedly to switch the picture layout
16. AI Key
Press repeatedly to select and enable the Presenter Tracking, Smart Gallery, Speaker Framing, Group Framing or close the tracking function
17. Preset Key
Successively press [Preset] + Number key (1-3) to set the preset position

5 AI Tracking

Camera supports Presenter Tracking, Smart Gallery, Speaker Framing, Group Framing and Gesture Control tracking functions.

5.1 Presenter Tracking

➤ **Operation**

Step 1 Press the [AI] key on the remote control repeatedly to select the Presenter Tracking function, the “AI” icon will be displayed in the lower-left corner of the screen.

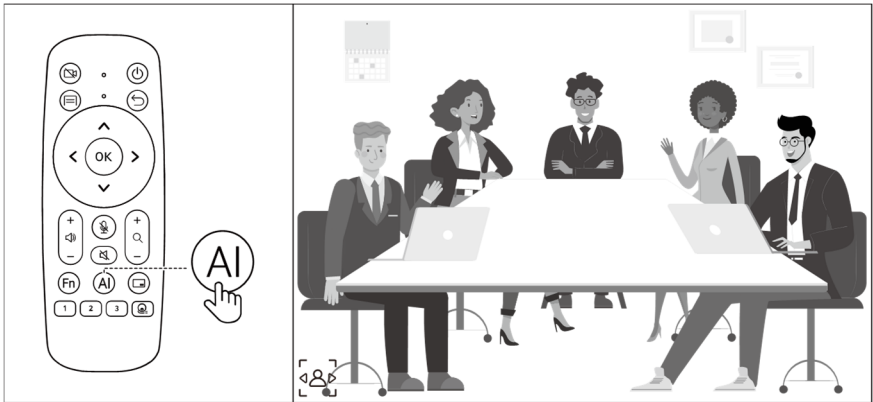

Step 2 Face the camera and make the “hand” gesture, a green frame will appear on the screen and frame the position of the gesture to select the person to be tracked. After the tracked person has been selected, the screen will display the “Presenter Tracking Active” prompt, indicating that tracking mode has been successfully activated (Note: Please release the gesture after tracking mode has been successfully activated).

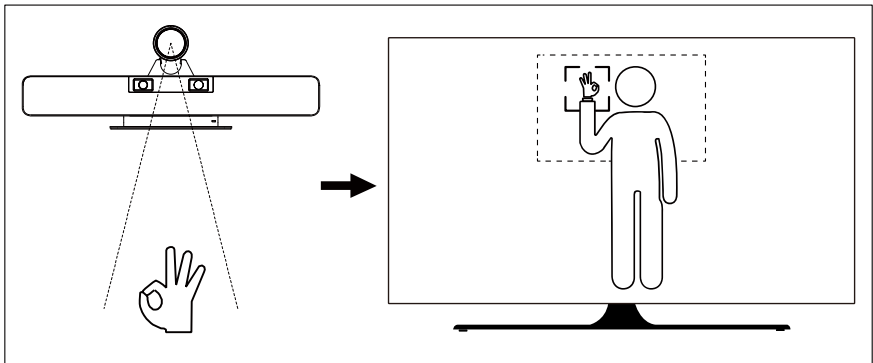

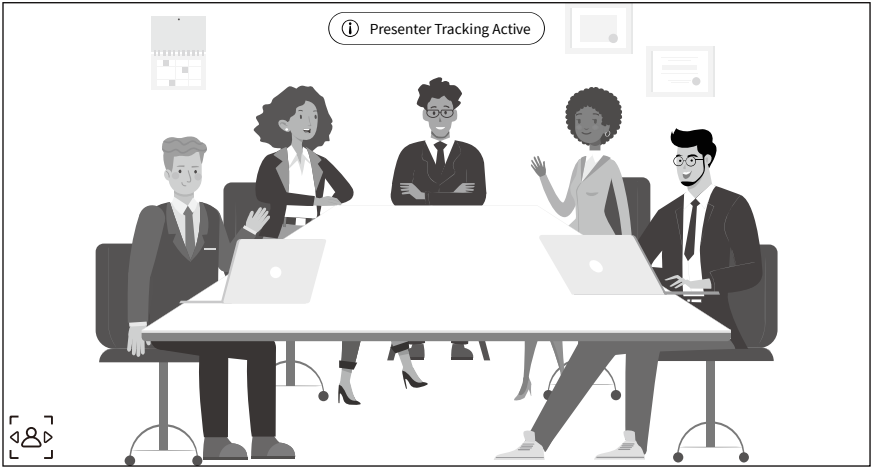

Step 3 When the tracked person moves, the camera will automatically lock the position and give a close-up image.



Step 4 Face the camera and make the “” gesture, the Presenter Tracking function will be turned off and the screen will display “Presenter Tracking Inactive”.

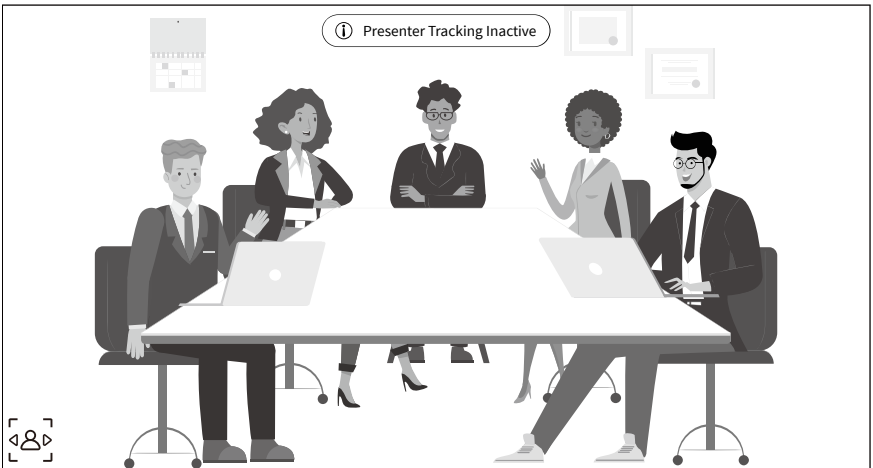
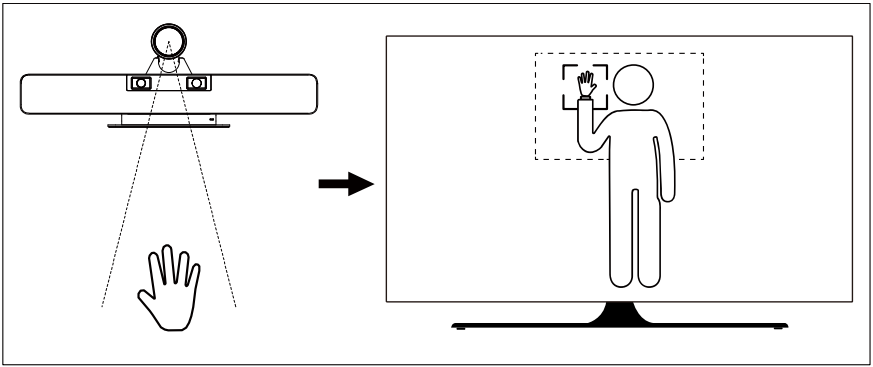

Step 5 Press the [↵] key on the remote control to exit the tracking mode.



Note

When making the “” gesture toward the camera, please place your hand one fist away from your ears and no more than two fists away.

5.2 Speaker Framing

➤ Operation

Step 1 Press the [AI] key on the remote control repeatedly to select and enable the Speaker Framing function, the “” icon will be displayed in the lower-left corner of the screen.

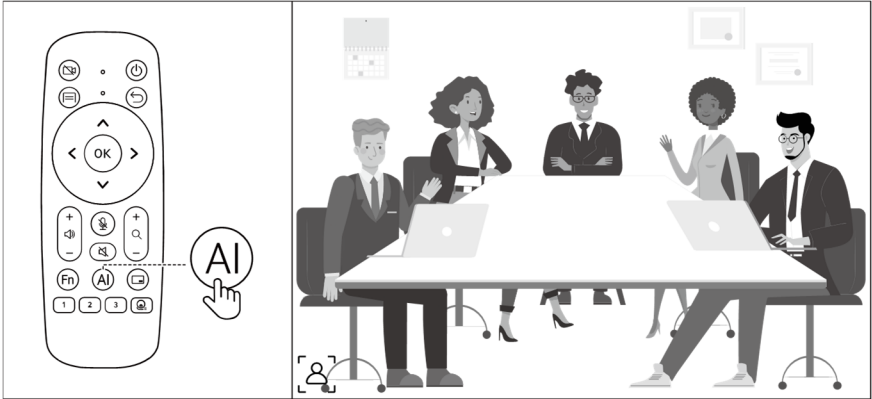

Step 2 When the participant speaks, the camera will automatically lock the speaker's position and give a close-up image based on the sound source.



Step 3 Press the [] key on the remote control to exit the tracking mode.

5.3 Group Framing

➤ **Operation**

Step 1 Press the [AI] key on the remote control repeatedly to select and enable the Group Framing function, the “” icon will be displayed in the lower-left corner of the screen.

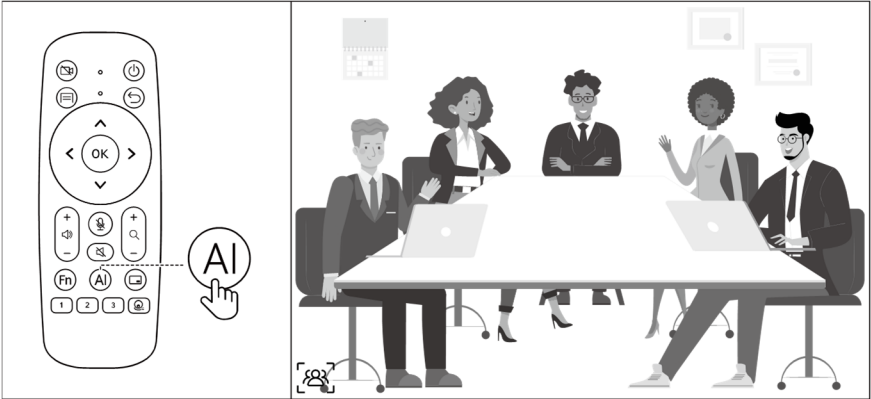

Step 2 When the participant moves, the camera will automatically adjust the image for the best composition using facial recognition.



Step 3 Press the  key on the remote control to exit the tracking mode.

5.4 Smart Gallery

➤ **Operation**

Step 1 Press the [AI] key on the remote control repeatedly to select and enable the Smart Gallery function, the “AI” icon will be displayed in the lower-left corner of the screen.

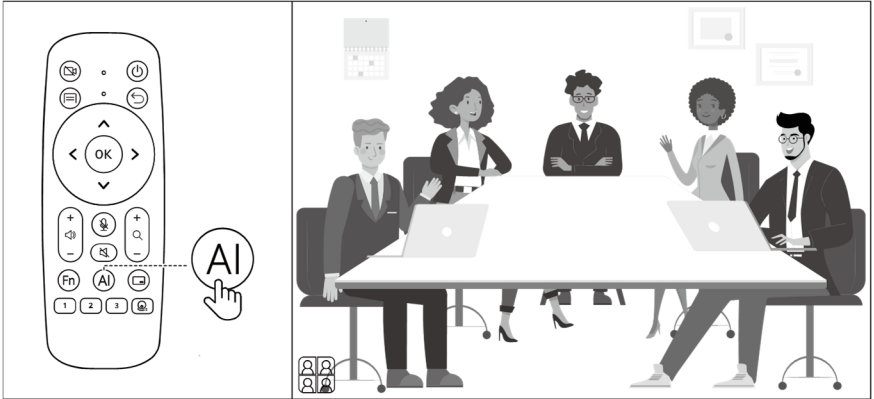

Step 2 The meeting layout will change according to the number of participants, and the close-up images of participants will be extracted and arranged intelligently (refer to the below figure for specific layouts).



Step 3 Press the [↶] key on the remote control to exit the tracking mode.

6 BYOM

Camera supports wired screen sharing to share the input audio and video sources to the VideoBar, which then outputs to TV or other display devices. It also supports BYOM to transfer the audio and video sources from the VideoBar to PC via USB. After enabling the Power Interface in the menu, the camera will display the BYOM instruction interface when it starts up.

➤ Operation

Step 1 Press the [Menu] key on the remote control to select “General Setting > Power Interface > On” to enable the BYOM instruction interface to be displayed when the Camera starts up.

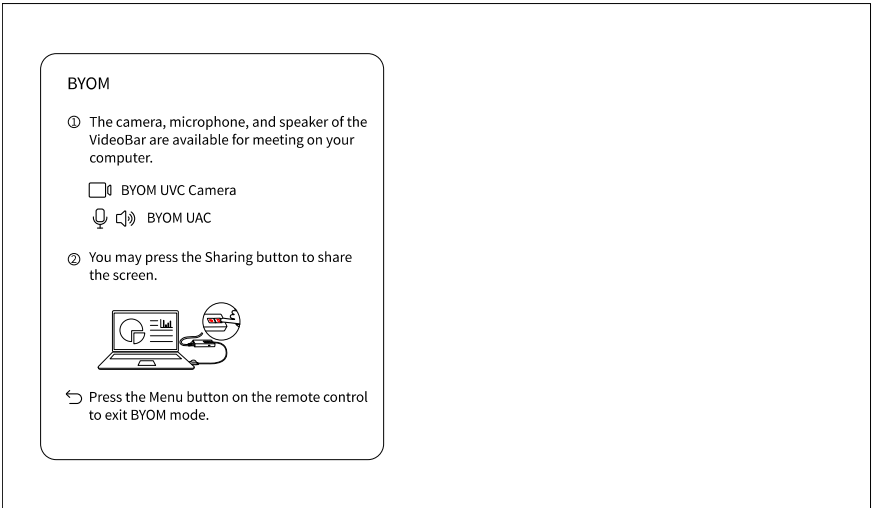

Step 2 Please refer to the instructions to complete the operation and share the screen of PC to VideoBar.

Step 3 Press the [↵] key on the remote control to exit the BYOM instruction interface.

7 GUI Menu

7.1 MENU

Press the [MENU] key to display the main menu. Use the arrow key to move the cursor to the desired item and press the [OK] key to confirm to enter the sub-menu.

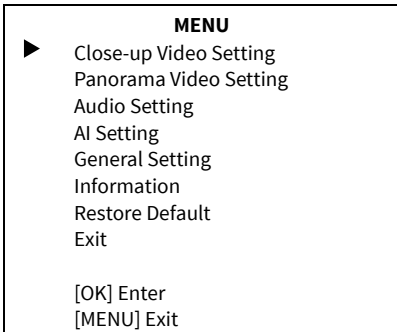

7.2 CLOSE-UP VIDEO SETTING

Move the cursor in the main menu to select “Close-up Video Setting” and press the [OK] key to enter the Close-up Video Setting interface.

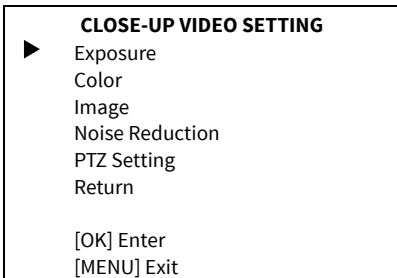

7.2.1 EXPOSURE

Move the cursor in the Close-up Video Setting menu to select “Exposure” and press the [OK] key to enter the Close-up Exposure interface.

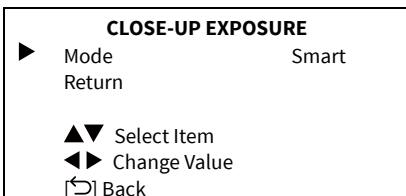

Mode: Smart, Full Auto, Manual, SAE, AAE, Bright.
ExpCompMode (Exposure Compensation Mode): On, Off (Effective in Full Auto mode).

ExpComp (Exposure Compensation Value): -7~7 (Effective in ExpCompMode On).

GainLimit: 0~15 (Effective in Full Auto, AAE, Bright mode).

Metering: Average, Center, Bottom, Top (Effective in Full Auto, AAE, Bright mode).

Backlight: On, Off (Effective in Full Auto mode).

Iris: F1.8, F2.0, F2.4, F2.8, F3.4, F4.0, F4.8, F5.6, F6.8, F8.0, F9.6, F11.0, Close (Effective in Manual, AAE mode).

Shutter: 1/30s, 1/60s, 1/90s, 1/100s, 1/125s, 1/200s, 1/250s, 1/350s, 1/500s, 1/725s, 1/1000s, 1/1500s, 1/2000s, 1/3000s, 1/4000s, 1/6000s, 1/10000s (Effective in Manual, SAE mode).

Gain: 0~7 (Effective in Manual mode).

Bright: 0~17 (Effective in Bright mode).

DRC Strength: 0~8.

7.2.2 COLOR

Move the cursor in the Close-up Video Setting menu to select “Color” and press the [OK] key to enter the Close-up Color interface.

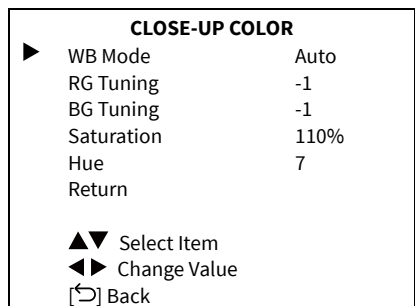

WB Mode (White Balance Mode): Auto, One Push, Manual, VAR.

RG Tuning (Red Gain Tuning): -10~10 (Effective in Auto, One Push, VAR mode).

BG Tuning (Blue Gain Tuning): -10~10 (Effective in Auto, One Push, VAR mode).

Red Gain: 0~255 (Effective in Manual mode).

Blue Gain: 0~255 (Effective in Manual mode).

ColorTemp: 2500K~8000K (Effective in VAR mode).

Saturation: 60%~200%.

Hue: 0~14.

7.2.3 IMAGE

Move the cursor in the Close-up Video Setting menu to select “Image” and press the [OK] key to enter the Close-up Image interface.

CLOSE-UP IMAGE	
▶ Luminance	7
Contrast	7
Sharpness	Auto
Gamma	EXT
Style	Default
Return	
▲▼ Select Item	
◀▶ Change Value	
[↵] Back	

Luminance: 0~14.

Contrast: 0~14.

Sharpness: 0~15, Auto.

Gamma: EXT, Default, 0.45, 0.5, 0.56, 0.63.

Style: Default.

7.2.4 NOISE REDUCTION

Move the cursor in the Close-up Video Setting menu to select “Noise Reduction” and press the [OK] key to enter the Close-up Noise Reduction interface.

CLOSE-UP NOISE REDUCTION	
▶ 2D NR	1
3D NR	Auto
Return	
▲▼ Select Item	
◀▶ Change Value	
[↵] Back	

2D NR (2D Noise Reduction): Off, Auto, 1~5.

3D NR (3D Noise Reduction): Off, Auto, 1~8.

7.2.5 P/T/Z Setting

Move the cursor in the Close-up Video Setting menu to select “P/T/Z Setting” and press the [OK] key to enter the Close-up P/T/Z Setting interface.

CLOSE-UP P/T/Z SETTING	
▶ AF-Sense	Low
AF-Zone	Front
Speed By Zoom	On
Image Freeze	Off
Call Preset Speed	18
Pre Zoom Speed	5
Return	
[MENU] Return / [HOME] Enter	

AF-Sense: Low, High, Normal.

AF-Zone: Front, Top, Middle, Bottom.

Speed By Zoom: On, Off.

Image Freeze: On, Off.

Call Preset Speed: 1~24.

Pre Zoom Speed: 0~7.

7.3 Panorama VIDEO SETTING

Move the cursor in the main menu to select “Panorama Video Setting” and press the [OK] key to enter the Panorama Video Setting interface.

PANORAMA VIDEO SETTING	
▶ Exposure	
Color	
Image	
Noise Reduction	
Return	
[OK] Enter	
[MENU] Exit	

7.3.1 EXPOSURE

Move the cursor in the Panorama Video Setting menu to select “Exposure” and press the [OK] key to enter the Panorama Exposure interface.

PANORAMA EXPOSURE	
▶ Mode	Full Auto
ExpCompMode	Off
Gain Limit	8
Metering	Average
Backlight	Off
DRC Strength	2
Return	
▲▼ Select Item	
◀▶ Change Value	
[↵] Back	

- Mode:** Full Auto, Manual, SAE, Bright.
- ExpCompMode** (Exposure Compensation Mode): On, Off (Effective in Full Auto mode).
- ExpComp** (Exposure Compensation Value): -7~7 (Effective in ExpCompMode On).
- GainLimit:** 0~15 (Effective in Full Auto, Bright mode).
- Metering:** Average, Center, Bottom, Top (Effective in Full Auto, Bright mode).
- Backlight:** On, Off (Effective in Full Auto mode).
- Shutter:** 1/30s, 1/60s, 1/90s, 1/100s, 1/125s, 1/200s, 1/250s, 1/350s, 1/500s, 1/725s, 1/1000s, 1/1500s, 1/2000s, 1/3000s, 1/4000s, 1/6000s, 1/10000s (Effective in Manual, SAE mode).
- Gain:** 0~7 (Effective in Manual mode).
- Bright:** 0~17 (Effective in Bright mode).
- DRC Strength:** 0~8.

7.3.2 COLOR

Move the cursor in the Panorama Video Setting menu to select “Color” and press the [OK] key to enter the Panorama Color interface.

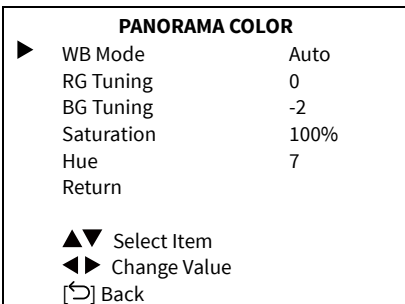

- WB Mode** (White Balance Mode): Auto, One Push, Manual, VAR.
- RG Tuning** (Red Gain Tuning): -10~10 (Effective in Auto, One Push, VAR mode).
- BG Tuning** (Blue Gain Tuning): -10~10 (Effective in Auto, One Push, VAR mode).
- Red Gain:** 0~255 (Effective in Manual mode).
- Blue Gain:** 0~255 (Effective in Manual mode).
- ColorTemp:** 2500K~8000K (Effective in VAR mode).
- Saturation:** 60%~200%.
- Hue:** 0~14.

7.3.3 IMAGE

Move the cursor in the Panorama Video Setting menu to select “Image” and press the [OK] key to enter the Panorama Image interface.

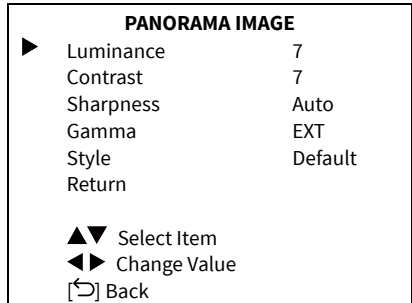

- Luminance:** 0~14.
- Contrast:** 0~14.
- Sharpness:** 0~15, Auto.
- Gamma:** EXT, Default, 0.45, 0.5, 0.56, 0.63.
- Style:** Default.

7.3.4 NOISE REDUCTION

Move the cursor in the Panorama Video Setting menu to select “Noise Reduction” and press the [OK] key to enter the Panorama Noise Reduction interface.

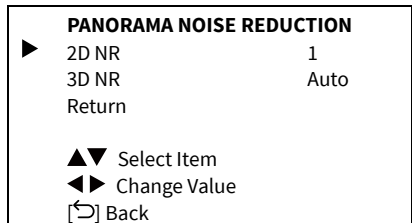

- 2D NR** (2D Noise Reduction): Off, Auto, 1~5.
- 3D NR** (3D Noise Reduction): Off, Auto, 1~8.

7.4 AUDIO SETTING

Move the cursor in the main menu to select “Audio Setting” and press the [OK] key to enter the Audio Setting interface.

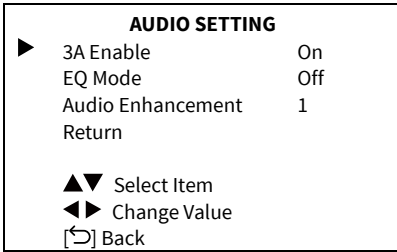

3A Enable: On, Off.

EQ Mode: On, Off.

Audio Enhancement (Set the output energy level of Speaker, the higher the energy value, the louder the output volume): Close, 1~3.

7.5 AI SETTING

Move the cursor in the main menu to select “AI Setting” and press the [OK] key to enter the AI Setting interface.

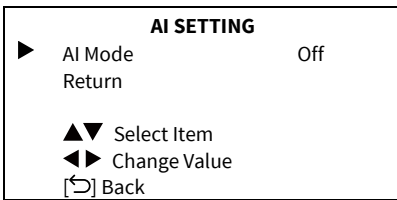

AI Mode: Off, Presenter Tracking, Smart Gallery, Speaker Framing, Group Framing.

AI Sub Mode: Close-up Mode, Auto Mode (Effective in Speaker Framing mode).

7.6 GENERAL SETTING

Move the cursor in the main menu to select “General Setting” and press the [OK] key to enter the General Setting interface.

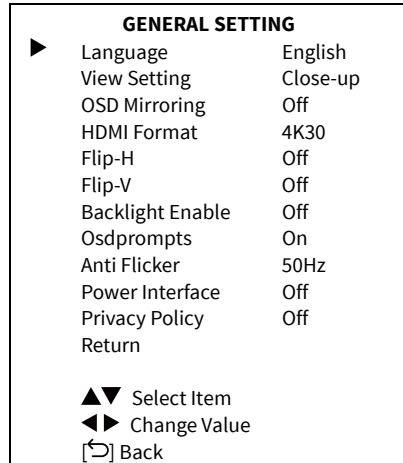

Language (Set the OSD interface language, and the WEB interface will be changed accordingly): English, 中文.

View Setting (Switch the output screen layout): Close-up, Panorama, Close-up_pip, Panorama_pip (Close-up - Close-up single frame; Panorama - Panorama single frame; Close-up_pip - Close-up large frame, panorama small frame; Panorama_pip - Panorama large frame, close-up small frame).

OSD Mirroring (Set the horizontal mirroring of OSD menu display): On, Off.

HDMI Format (Switch the output resolution of HDMI OUT): 4K30, 1080P60, 1080P50, 1080P30, 480P60.

Flip-H (Set the output screen to flip horizontally): On, Off.

Flip-V (Set the output screen to flip vertically): On, Off.

Backlight Enable (Select whether to allow backlight settings via UVC): On, Off (restart takes effect).

Osdprompts: On, Off (When OSD prompt is set to “On”, the interface displays prompts related to functions such as Presenter Tracking, setting/calling preset, etc.).

Anti Flicker: Off, 50Hz, 60Hz.

Power Interface: On, Off (When the power interface is set to “On”, the device displays the BYOM instruction interface when it starts up. Press the “Return” or “Menu” key on the remote control to exit this interface. Note: After exiting the BYOM instruction interface, restarting the device will display this screen again. When the power interface is set to “Off”, the BYOM instruction interface will no longer be displayed).

Privacy Policy: On, Off (When the privacy policy is set to “On”, the interface displays a video closed indicator, the close-up lens automatically moves to the lower left privacy position, and the privacy cover for the panorama lens is closed).



Note

The Privacy Policy will be activated in the following situations:

- Open/Close the Camera in meeting software such as Teams and Tencent Meeting to select exit or enter the privacy policy;
- During the meeting, open the Camera to exit the privacy policy. Camera will automatically enter the privacy policy while the meeting is exited;
- If there is no USB/BYOM streaming for 15 minutes, the Camera will automatically enter the privacy policy. Camera will automatically exit the privacy policy while the USB/BYOM streaming is enabled.

7.7 INFORMATION

Move the cursor in the main menu to select “Information” and press the [OK] key to enter the Information interface to check the device information.

INFORMATION

▶ Version SOC 9.0.61
 Model M15.RC
 Date 2025-05-06
 IP 192.168.100.88
 Gateway 192.168.100.254
 Netmask 255.255.255.0
 AF 20.4.33
 Return

▲▼ Select Item
 ◀▶ Change Value
 [↶] Back



Note

The above information is only for reference, please refer to the real product for the actual specifications.

7.8 RESTORE DEFAULT

Move the cursor in the main menu to select “Restore Default” and press the [OK] key to enter the Restore Default interface.

RESTORE DEFAULT

▶ Yes
 No
 Return

▲▼ Select Item
 ◀▶ Change Value
 [↶] Back

Restore Default: Yes, No.



Notice

When selecting “Yes” and confirming with the [OK] key, all parameters will be restored to default.



Note

GUI menu and device information are subject to change without notice.

8 WEB Settings

8.1 Access Camera

Access the camera’s IP address in the browser (default: 192.168.100.88) to pop up the login window, input the username (default: admin) and password (default: admin) and click the “Submit” to enter the WEB page as below:

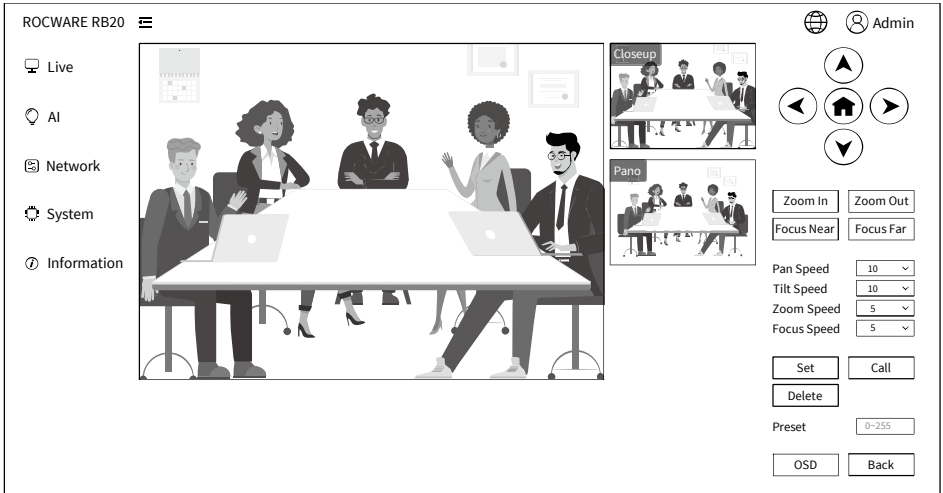

8.2 Control Camera

A. Video Display Window

The video display window matches the video resolution, the larger the resolution, the larger the window. Double click the display window to enter or exit the full-screen mode.

The status bar is located below the display window is shown as below:



⏸: Pause button

⏏: Full screen button

B. PTZ

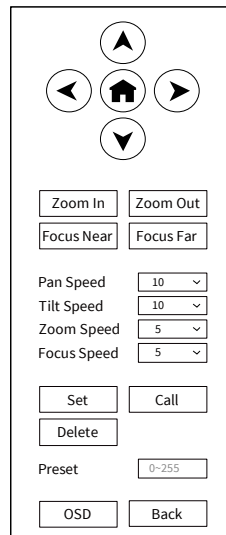

Pan and Tilt Control

Click the arrow buttons to turn PTZ to up, down, left and right, click the HOME button to return it to the middle position.

Zoom

Zoom In/Zoom Out camera lens.

Focus

Focus In/Focus Out.

PTZ Speeds

The Pan speed value can be set to 1~24; the Tilt speed value can be set to 1~20; the Zoom and Focus speed value can be set to 1~7.

Presets

Use the arrow button to turn the PTZ to the desired position, enter a preset number (0~255) in the preset box and click the "Set" button to save. When the PTZ turn to another position, enter the preset number and click the "Call" button to return the PTZ to the preset position. Click the "Delete" button to clear the saved presets.

OSD

Click the "OSD" button, the on-screen menu will appear in the upper-left corner of the video display window. Use the up and down arrow buttons to select the menu, click the HOME button to confirm and enter the sub-menu, and use the left and right arrow buttons to change the sub-menu parameters. After making changes, click the 'Back' button to save the settings and return to the previous menu.

C. Language

Click the "🌐" button to display the language box, select "中文" or "English" to change the language of the webpage.

D. Admin

Home: Return to the home page of the WEB.

Logout: Exit to the WEB login page.

8.3 Live (Closeup)

8.3.1 Exposure

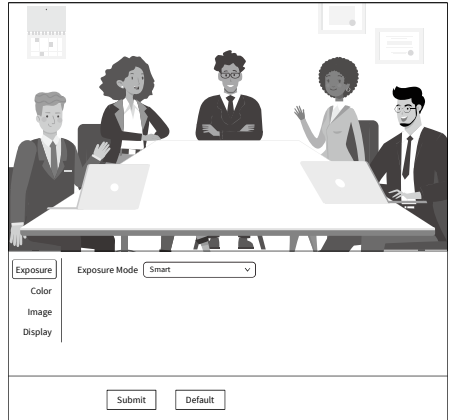

Exposure Mode: Full Auto, Manual, Shutter Priority, Iris Priority, Bright Priority, Smart.

ExpComp Mode (Exposure Compensation Mode): On, Off (Effective in Full Auto mode).

ExpComp (Exposure Compensation Value): -7~7 (Effective in ExpComp Mode On).

Gain Limit: 0~15 (Effective in Full Auto, Iris Priority, Bright Priority mode).

Metering Mode: Average, Center, Bottom, Top (Effective in Full Auto, Iris Priority, Bright Priority mode).

Backlight: On, Off (Effective in Full Auto mode).

Iris: F1.8, F2.0, F2.4, F2.8, F3.4, F4.0, F4.8, F5.6, F6.8, F8.0, F9.6, F11.0, Close (Effective in Manual, Iris Priority mode).

Shutter: 1/30s, 1/60s, 1/90s, 1/100s, 1/125s, 1/200s, 1/250s, 1/350s, 1/500s, 1/725s, 1/1000s, 1/1500s, 1/2000s, 1/3000s, 1/4000s, 1/6000s, 1/10000s (Effective in Manual, Shutter Priority mode).

Gain: 0~7 (Effective in Manual mode).

Bright: 0~17 (Effective in Bright Priority mode).

DRC: 0~8.

8.3.2 Color

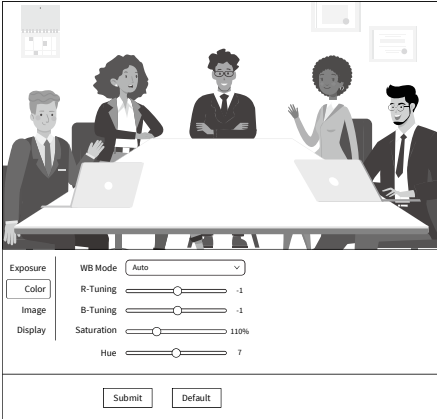

WB Mode (White Balance Mode): Auto, One Push, Manual, Temp.

R-Tuning (Red Gain Tuning): -10~10 (Effective in Auto, One Push, Temp mode).

B-Tuning (Blue Gain Tuning): -10~10 (Effective in Auto, One Push, Temp mode).

R-Gain: 0~255 (Effective in Manual mode).

B-Gain: 0~255 (Effective in Manual mode).

Color Temp: 2500K~8000K (Effective in Temp mode).

Saturation: 60%~200%.

Hue: 0~14.

8.3.3 Image

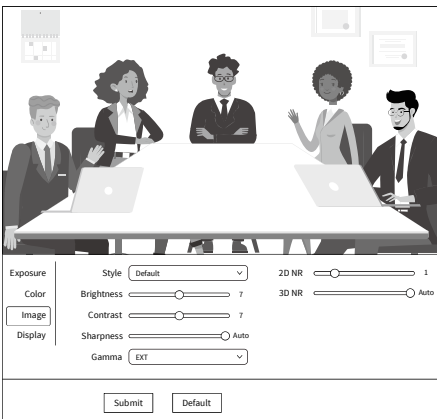

Style: Default.

Brightness: 0~14.

Contrast: 0~14.

Sharpness: 0~15, Auto.

Gamma: Default, 0.45, 0.5, 0.56, 0.63, EXT.

2D NR (2D Noise Reduction): Off, 1~5, Auto.

3D NR (3D Noise Reduction): Off, 1~8, Auto.

8.3.4 Display

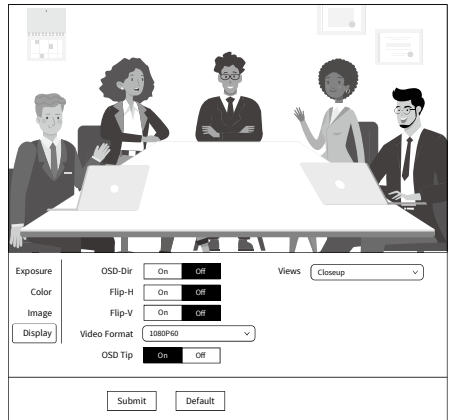

OSD-Dir: On, Off.

Flip-H: On, Off.

Flip-V: On, Off.

Video Format: 4KP30, 1080P60, 1080P50, 1080P30, 480P60.

OSD Tips: On, Off.

Views: Closeup-Pano, Pano-Closeup, Closeup, Pano.

8.4 Live (Pano)

8.4.1 Exposure



Exposure Mode: Full Auto ▼ DRC: 0 ▬ 2

Color ExpComp Mode: On Off

Image Gain Limit: 0 ▬ 8

Display Metering Mode: Average ▼

Backlight: On Off

Submit Default

Exposure Mode: Full Auto, Manual, Shutter Priority, Bright Priority.

ExpComp Mode (Exposure Compensation Mode): On, Off (Effective in Full Auto mode).

ExpComp (Exposure Compensation Value): -7~7 (Effective in ExpCompMode On).

Gain Limit: 0~15 (Effective in Full Auto, Bright Priority mode).

Metering Mode: Average, Center, Bottom, Top (Effective in Full Auto, Bright Priority mode).

Backlight: On, Off (Effective in Full Auto mode).

Shutter: 1/30s, 1/60s, 1/90s, 1/100s, 1/125s, 1/200s, 1/250s, 1/350s, 1/500s, 1/725s, 1/1000s, 1/1500s, 1/2000s, 1/3000s, 1/4000s, 1/6000s, 1/10000s (Effective in Manual, Shutter Priority mode).

Gain: 0~7 (Effective in Manual mode).

Bright: 0~17 (Effective in Bright Priority mode).

DRC: 0~8.

8.4.2 Color



Exposure WB Mode: Auto ▼

Color R-Tuning: 0 ▬

Image B-Tuning: -2 ▬

Display Saturation: 100% ▬

Hue: 0 ▬ 7

Submit Default

WB Mode (White Balance Mode): Auto, One Push, Manual, Temp.

R-Tuning (Red Gain Tuning): -10~10 (Effective in Auto, One Push, Temp mode).

B-Tuning (Blue Gain Tuning): -10~10 (Effective in Auto, One Push, Temp mode).

R-Gain: 0~255 (Effective in Manual mode).

B-Gain: 0~255 (Effective in Manual mode).

Color Temp: 2500K~8000K (Effective in Temp mode).

Saturation: 60%~200%.

Hue: 0~14.

8.4.3 Image



Exposure Style: Default ▼ 2D NR: 0 ▬ 1

Color Brightness: 7 ▬ 3D NR: Auto ▬

Image Contrast: 7 ▬

Display Sharpness: Auto ▬

Gamma: EXT ▼

Submit Default

- Style:** Default.
- Brightness:** 0~14.
- Contrast:** 0~14.
- Sharpness:** 0~15, Auto.
- Gamma:** Default, 0.45, 0.5, 0.56, 0.63, EXT.
- 2D NR (2D Noise Reduction):** Off, 1~5, Auto.
- 3D NR (3D Noise Reduction):** Off, 1~8, Auto.

8.4.4 Display

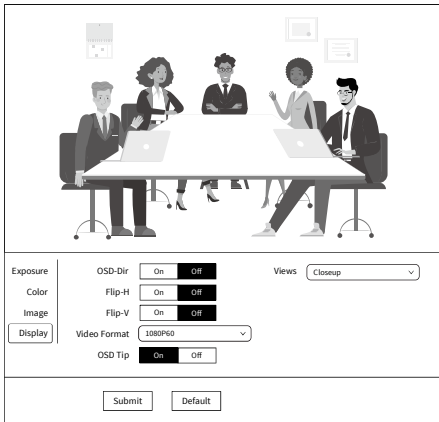

- OSD-Dir:** On, Off.
- Flip-H:** On, Off.
- Flip-V:** On, Off.
- Video Format:** 4KP30, 1080P60, 1080P50, 1080P30, 480P60.
- OSD Tips:** On, Off.
- Views:** Closeup-Pano, Pano-Closeup, Closeup, Pano.

8.5 AI

8.5.1 Settings

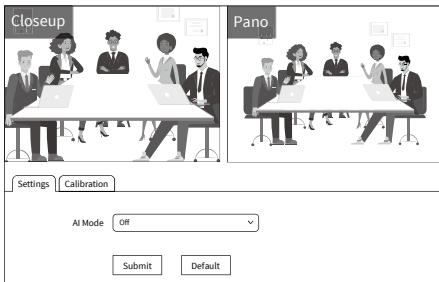

- AI Mode:** Off, Presenter Tracking, Smart Gallery, Speaker Framing, Group Framing.
- Track Guard:** On, Off (Effective in Smart Gallery mode).
- Response Speed:** Low, Median, Fast (Effective in Speaker Framing mode).

8.5.2 Calibration

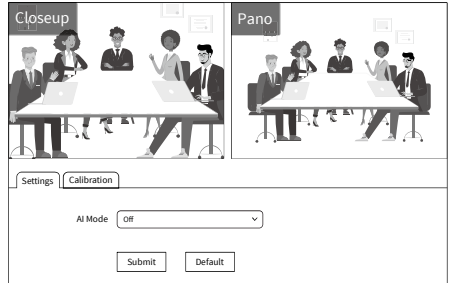

The camera calibration function has been configured before leaving the factory. If you need to reconfigure it, please contact the device manufacturer.

8.6 Network

8.6.1 Lan

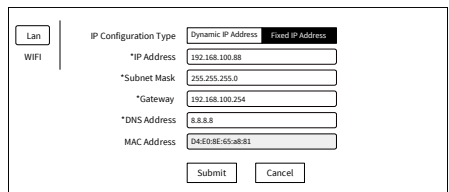

The default IP address of Lan is 192.168.100.88. The MAC address cannot be changed.

8.6.2 WIFI

Channel	Frequency	Signal	WiFi SSID
36	5.18GHz	-35dBm strong	FQ Office
40	5.18GHz	-40dBm strong	Test
44	5.22GHz	-50dBm medium	Meeting Room
44	5.22GHz	-70dBm medium	Image Test
48	5.22GHz	-75dBm weak	Hardware
153	5.18GHz	-90dBm weak	MES2025
161	5.18GHz	-95dBm weak	Guest

WiFi SSID: Display the current WiFi name.

Current Channel: Display the current channel value.

Current Frequency: Display the current frequency value.

Current Signal: Display the current signal value.

WiFi List: Click “Refresh” button to refresh the WiFi hotspot.

Channel Setting: Auto, 36, 40, 44, 48,153, 161.



- The WiFi SSID, Current Channel, Current Frequency, Current Signal cannot be changed.
- When the Current Signal is 0dBm, it indicates that no other devices are connected to this device via the hotspot.

8.7 System

8.7.1 Initialize

Reboot

Click the “Reboot” button to pop up “Please press OK to reboot the camera.” prompt box, select “OK” to restart the system.

Factory Default

Click the “Factory Default” button to pop up “Would you like to restart and restore factory settings?” prompt box, select “OK” to restore the factory settings.

8.7.2 User

User Management

Change the user’s login password (Only letters, numbers and symbols +,*,/^\$&_., are supported).

Guest Management

Change the guest’s login password (Only letters, numbers and symbols +,*,/^\$&_., are supported).

8.7.3 Log

Click the “Download Log” button to download the logs to the local device for system issue troubleshooting.

8.8 Information

8.8.1 Information

Displays the current camera's Device ID, Device Type, Software Version, Version Date, Webware Version and MAC Address.

8.8.2 System Upgrade

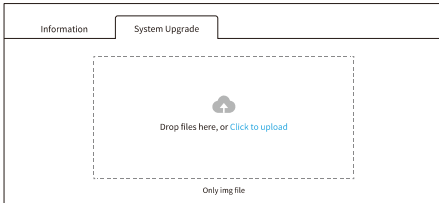

Camera supports online upgrades. Drag the upgrade package into the system upgrade box, or click “Click to upload” to select the upgrade package and follow the on-screen instructions to upgrade the system.



Note
WEB interface and device information are subject to change without notice.

9 Troubleshooting

Image

- The monitor shows no image.
 - 1) Ensure that the camera power supply is connected, the voltage is normal, and the power indicator is always on.
 - 2) Turn off the power switch to check that the camera is self-testing.
 - 3) Ensure the cable of the video platform and TV is in the correct connection.
- Image jitters after the camera is connected correctly.
 - 1) Ensure that the camera installation is in a stable position.
 - 2) Check if any vibrating machinery or object is near the camera.
- There is no video image in the browser.

IE browser and IE core browser are not supported, the camera video image will be displayed correctly when using Google, Firefox, Edge, etc.

- Unable to access through the browser.
 - 1) Use a PC to connect to the network to test whether the network access is functional. Eliminate network faults that may be caused by cable faults and viruses until the PC and the camera can pass the Ping test.
 - 2) Disconnect the network, connect the camera with the PC separately and reset the PC's IP address if necessary.
 - 3) Ensure that the IP address, subnet mask and gateway settings are correct.
 - 4) Check if the MAC address conflicts.
 - 5) Check if the web port is modified. The default setting is 80.
- Forget the IP address or login password.

The default IP address is: 192.168.100.88; the default username and password are: admin (After changing the password, please log in with the new password).

Control

- Remote control malfunctioning.
 - 1) Check and replace with new batteries.
 - 2) Ensure that the camera working mode is correct.

