

CDEG3 Series

Commercial Display User Guide

IMPORTANT: Please read this User Guide to obtain important information on installing and using your product in a safe manner, as well as registering your product for future service. Warranty information contained in this User Guide will describe your limited coverage from ViewSonic® Corporation, which is also found on our web site at <http://www.viewsonic.com> in English, or in specific languages using the Regional selection box of our website.

Model No. VS20767 | VS20768 | VS20772 | VS20769 | VS20770 | VS20771
P/N: CDE43G3 | CDE55G3 | CDE65G3 | CDE75G3 | CDE86G3 | CDE98G3

Thank you for choosing ViewSonic®

As a world-leading provider of visual solutions, ViewSonic® is dedicated to exceeding the world's expectations for technological evolution, innovation, and simplicity. At ViewSonic®, we believe that our products have the potential to make a positive impact in the world, and we are confident that the ViewSonic® product you have chosen will serve you well.

Once again, thank you for choosing ViewSonic®!

Safety Precautions

Please read the following **Safety Precautions** before you start using the device.

- Keep this user guide in a safe place for later reference.
- Read all warnings and follow all instructions.
- Do not use the device near water. To reduce the risk of fire or electric shock, do not expose the device to moisture.
- Never remove the rear cover. This display contains high-voltage parts. You may be seriously injured if you touch them.
- Avoid exposing the device to direct sunlight or other sources of sustained heat.
- Do not install near any heat sources such as radiators, heat registers, stoves, or other devices (including amplifiers) that may increase the temperature of the device to dangerous levels.
- Use a soft, dry cloth to clean the external housing. For more information, refer to the "Maintenance" section.
- When moving the device, be careful not to drop or bump the device on anything.
- Do not place the device on an uneven or unstable surface. The device may fall over resulting in an injury or a malfunction.
- Do not place any heavy objects on the device or connection cables.
- If smoke, an abnormal noise, or a strange odor is present, immediately turn the device off and call your dealer or ViewSonic®. It is dangerous to continue using the device.
- The device is a monitor with an LED backlight intended for general office use.
- Do not attempt to circumvent the safety provisions of the polarized or grounding-type plug. A polarized plug has two blades with one wider than the other. A grounding-type plug has two blades and a third grounding prong. The wide blade and the third prong are provided for your safety. If the plug does not fit into your outlet, obtain an adapter and do not attempt to force the plug into the outlet.
- When connecting to a power outlet, DO NOT remove the grounding prong. Please ensure grounding prongs are NEVER REMOVED.
- Protect the power cord from being treaded upon or pinched, particularly at the plug, and at the point where it emerges from the equipment. Ensure that the power outlet is located near the equipment so that it is easily accessible.
- Only use attachments/accessories specified by the manufacturer.
- When a cart is used, use with caution when moving the cart/equipment combination to avoid injury from tipping over.

- Disconnect the power plug from the AC outlet if the device is not being used for a long period of time.
- Place the device in a well-ventilated area. Do not place anything on the device that prevents heat dissipation. Also, avoid any direct lighting.

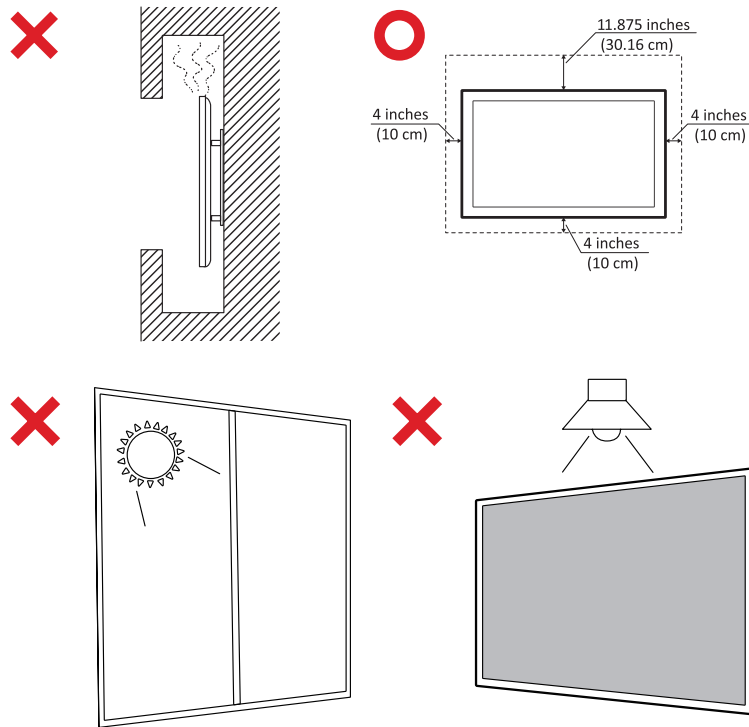

- The handles must not be used for mechanical lifting or hoisting. They are designed only for manual handling.
- Team lifting is recommended:
 - » For 86" products: At least four people are recommended for handling.
 - » For products larger than 86": At least six people are recommended for handling.

IMPORTANT

To ensure the optimal performance and longevity of your display, it is essential to follow the recommended handling, mounting, and storage procedures. Placing the display in a horizontal position can lead to a range of potential issues, including:

- Excessive stress on the display's structural components, resulting in the formation of cracks or distortions along the edges.
- Uneven weight distribution, which can cause the screen to warp, sustain internal damage, or crack over time.
- Thermal-related damage, as the internal components may not be able to dissipate heat as intended, leading to potential failure or permanent damage.

Furthermore, altering the display's form can also compromise the integrity of its internal components, including the sensitive LCD cells, which can result in a permanent degradation of the display's quality.

To prevent such issues and maintain the display's optimal condition, it is recommended to always mount, handle, transport, and store it in a vertical position. Failure to do so may void the warranty and compromise the display's performance and lifespan.

Note: Any damage resulting from the misuse or improper handling of the display is not covered under warranty

CAUTION:

Immediately unplug your device from the wall outlet and refer servicing to a qualified service personnel under the following conditions:

- When the power supply cord or plug is damaged.
- If liquid has been spilled onto or objects have fallen into the unit.
- If the unit has been exposed to moisture.
- If the unit does not operate normally or has been dropped.

Never place the device in an unstable location. The device may fall, causing serious personal injury or death. Many injuries, particularly to children, can be avoided by taking simple precautions such as:

- Using cabinets or stands recommended by the manufacturer of the device.
- Only using furniture that can safely support the device.
- Ensuring the device is not overhanging the edge of the supporting furniture.
- Not placing the device on tall furniture (e.g., cupboards or bookcases) without anchoring both the furniture and the device to a suitable support.
- Not placing the device on cloth or other materials that may be located between the device and supporting furniture.
- Educating children about the dangers of climbing on furniture to reach the device or its controls.

If the existing device is going to be retained and relocated, the same considerations as above should be applied.

Contents

Safety Precautions.....	3
Introduction	10
Package Contents	10
Wall Mounting Specifications (VESA)	11
Product Overview	12
CDE43G3	12
CDE55G3	13
CDE65G3	14
CDE75G3	15
CDE86G3	16
CDE98G3	17
Control Panel	18
CDE43G3	18
CDE55G3 CDE65G3 CDE75G3 CDE86G3 CDE98G3	19
I/O Panel	20
Remote Control	21
Installing the Batteries	23
Receiver Range	24
Making Connections	25
Connecting to Power	25
Connecting to External Devices	26
USB Type C Connection	26
HDMI Connection	26
VGA Connection	26
RS-232 Connection	27
USB Connection	28
USB Type A	28
USB Type C	28
Network Connection	29
Audio Connections	30
Audio In	30
Audio Out	30
SPDIF	30

Using Your Display.....	31
Turning the Display On/Off.....	31
On-Screen Display Menu	32
Input Source	33
Picture	34
Audio	36
Time.....	37
About.....	38
Advanced.....	39
Network.....	43
VGA	44
On-Screen Display Menu Tree.....	45
RS-232 Protocol.....	52
Description	52
RS-232 Hardware Specification	52
LAN Hardware Specification.....	53
RS-232 Communication Setting.....	53
LAN Communication Setting	53
Command Message Reference.....	53
Protocol	54
Set-Function Listing.....	54
Appendix.....	59
USB Media Supported Formats	59
Photo.....	59
Video	60
Audio	62
Timing Table	63
Graphic Resolution.....	63
HD Resolution.....	64
Troubleshooting	66
Maintenance.....	68

Regulatory and Service Information	69
Compliance Information.....	69
FCC Compliance Statement.....	69
Industry Canada Statement.....	69
CE Conformity for European Countries.....	69
Declaration of RoHS2 Compliance.....	70
ENERGY STAR Statement.....	71
Indian Restriction of Hazardous Substances	72
Product Disposal at End of Product Life	72
Copyright Information	73
Customer Service.....	74
Limited Warranty	75
Mexico Limited Warranty.....	78

Introduction

Package Contents

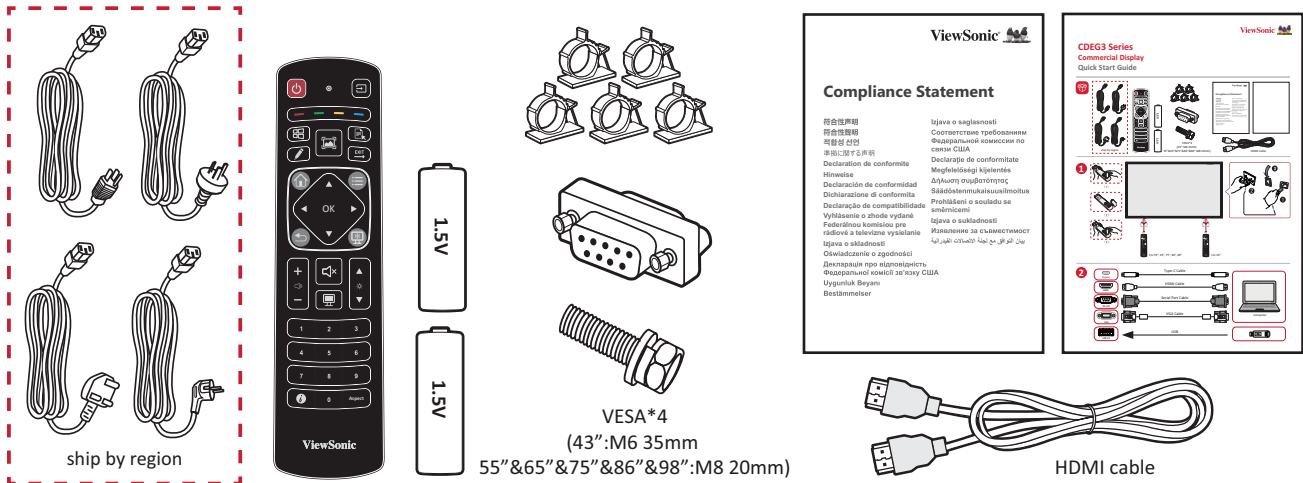

- Power Cable (3 m/9.84 ft)
- HDMI Cable (3 m /9.84 ft)
- Remote Control
- 2 x AAA Batteries
- Commercial Display
- RS-232 Adapter
- 4 x Mounting Screws
- 5 x Clamps
- Compliance Statement
- Quck Start Guide

Note: The cables included in your package may vary depending on your country or region. Please contact your local reseller for more information.

Wall Mounting Specifications (VESA)

Note: Please follow the instructions in the wall mount installation guide to install your wall mount or mobile mount bracket. If attaching to other building materials, please contact your nearest dealer.

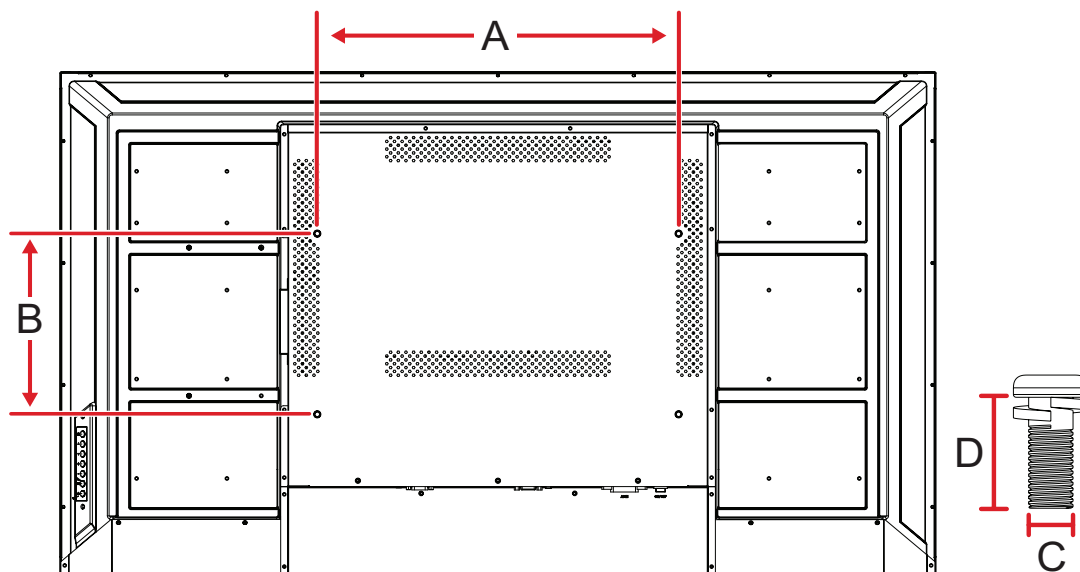

Model	VESA Spec. (A x B)	Standard Screw (C x D)	Quantity
CDE43G3	400 x 200 mm	M6 x 35 mm	4
CDE55G3	400 x 400 mm	M8 x 20 mm	4
CDE65G3	600 x 400 mm	M8 x 20 mm	4
CDE75G3	600 x 400 mm	M8 x 20 mm	4
CDE86G3	600 x 400 mm	M8 x 20 mm	4
CDE98G3	800 x 400 mm	M8 x 20 mm	4

Product Overview

CDE43G3

Front View



Rear View

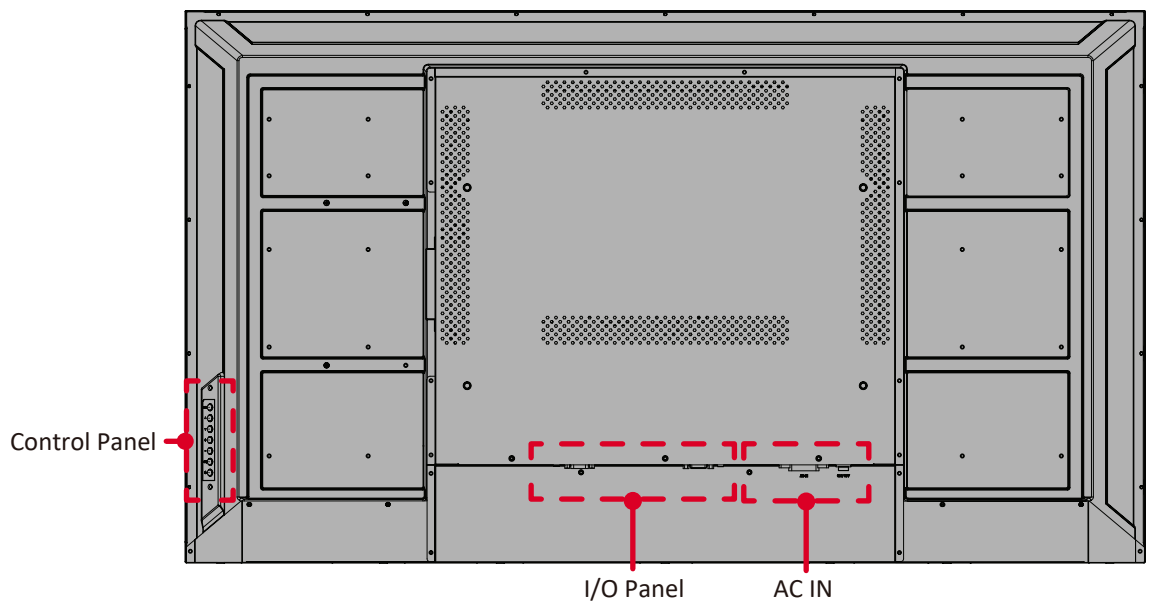

CDE55G3

Front View

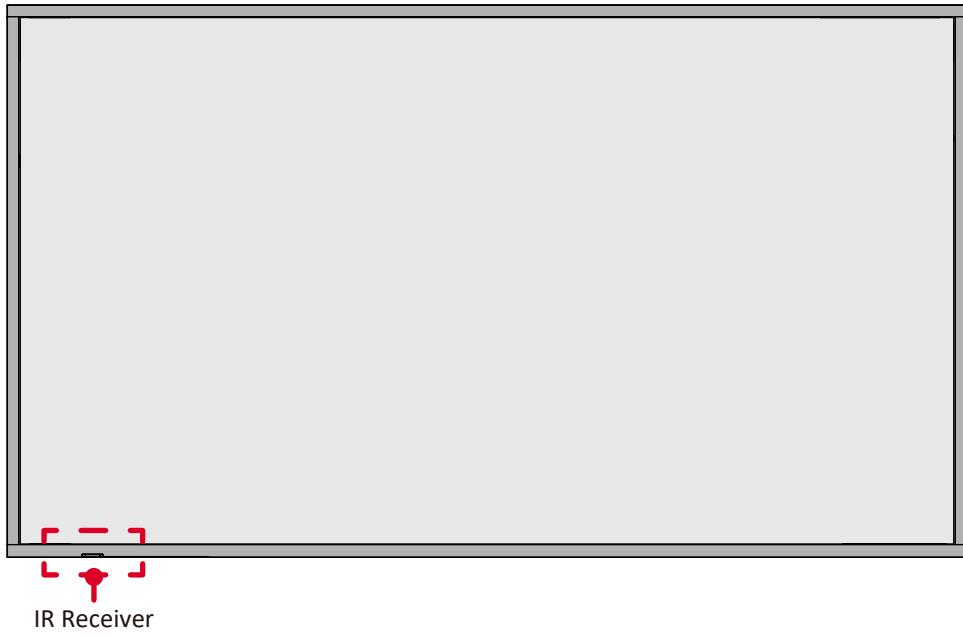

Rear View

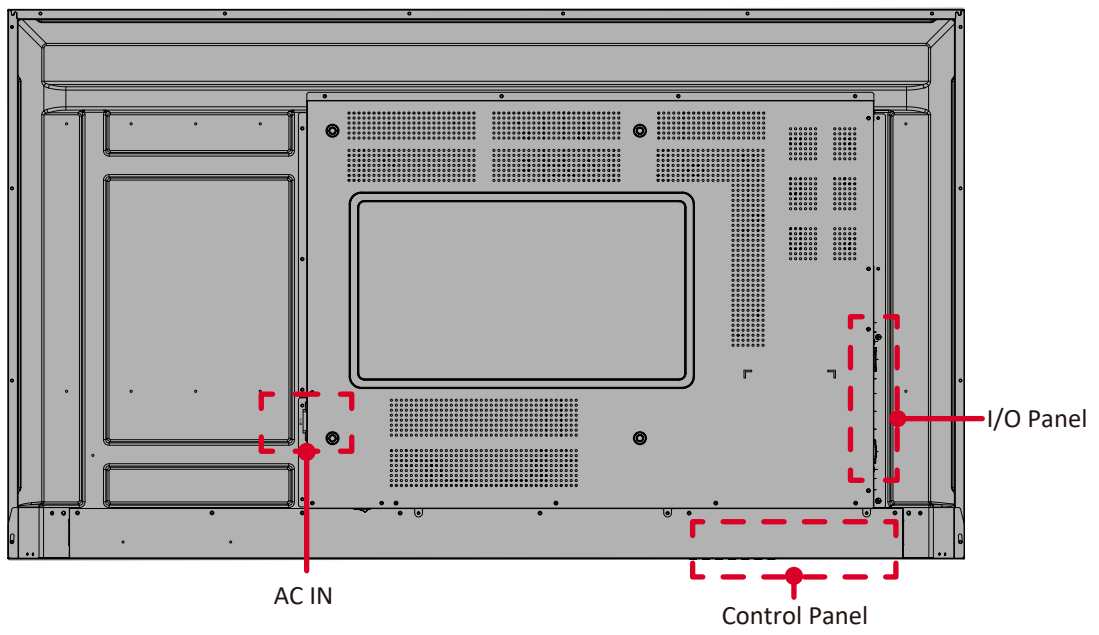

CDE65G3

Front View

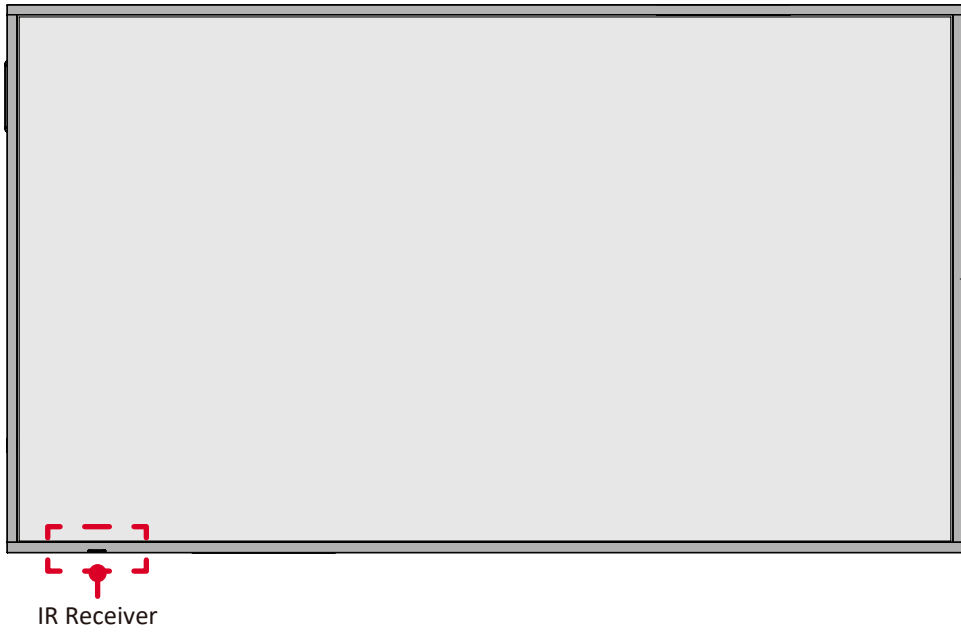

Rear View

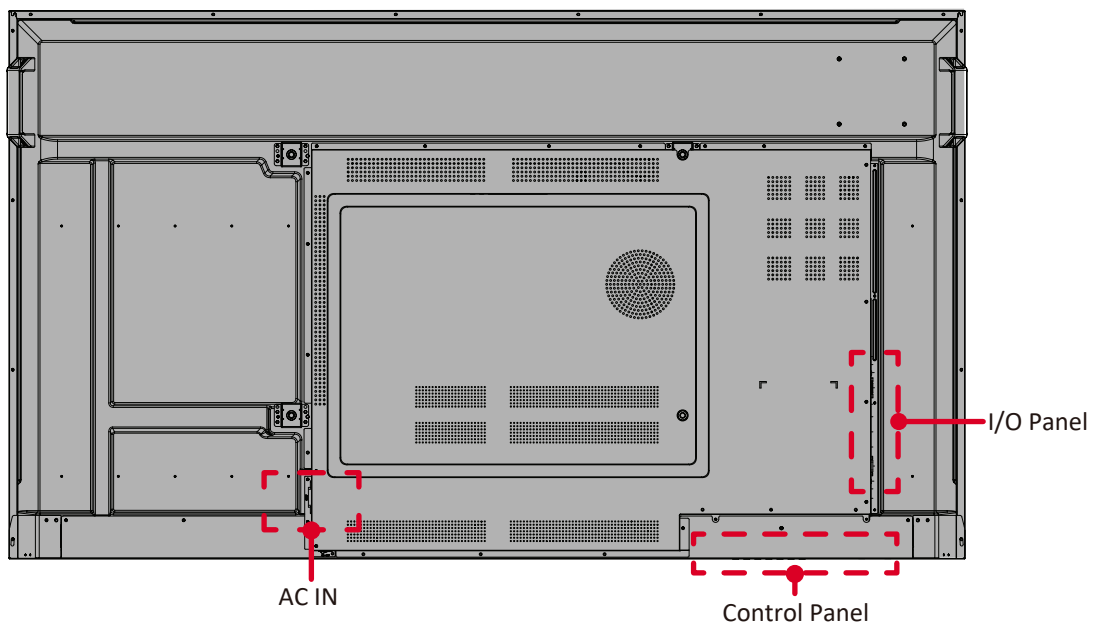

CDE75G3

Front View

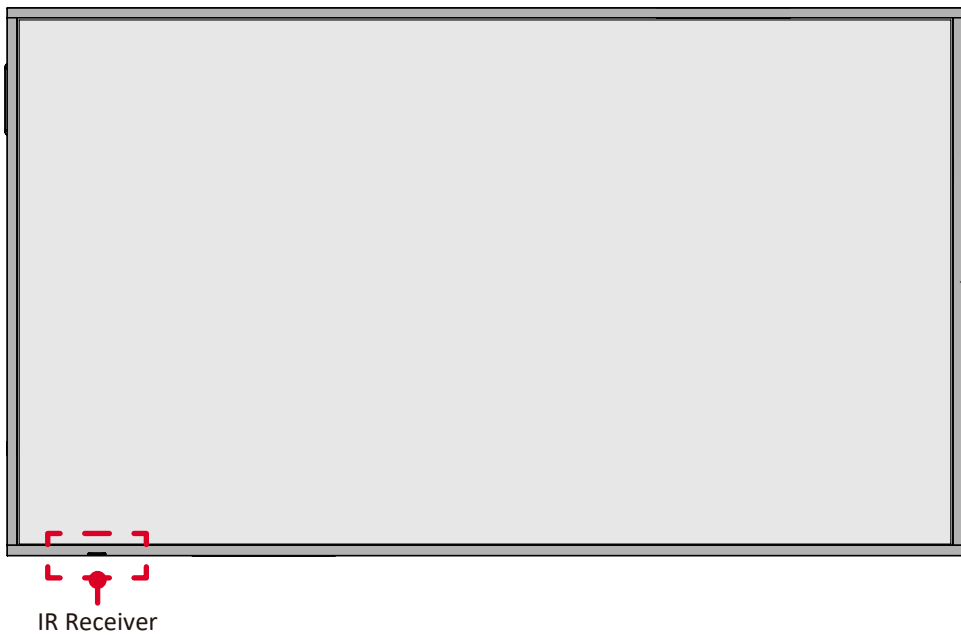

Rear View

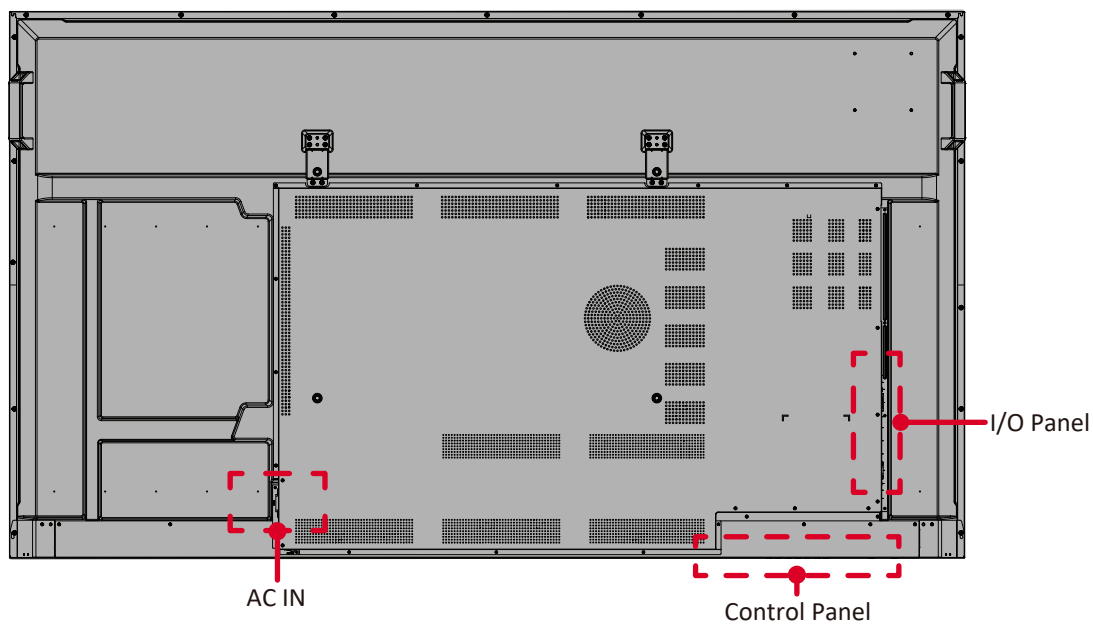

CDE86G3

Front View

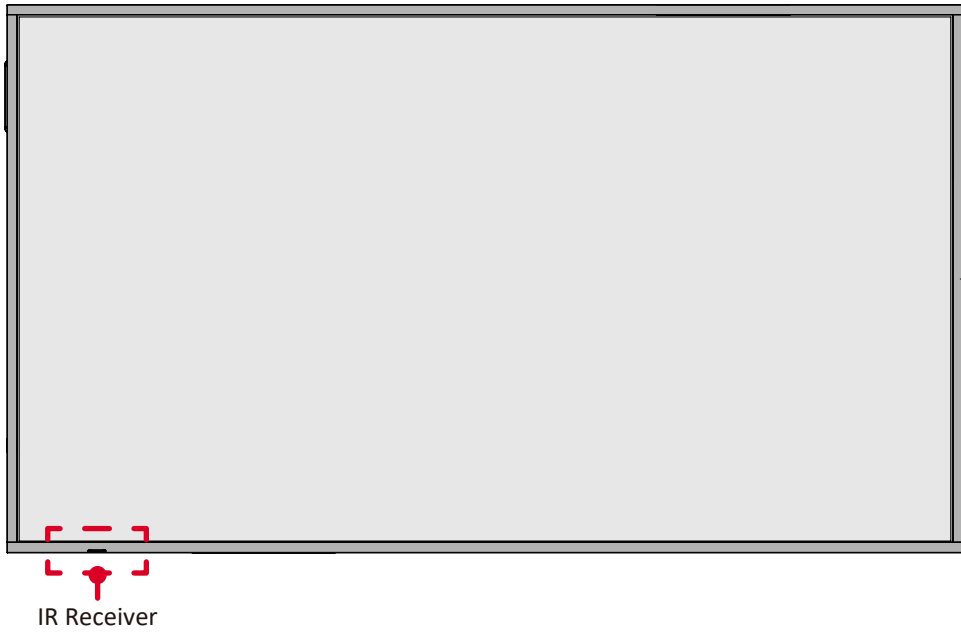

Rear View

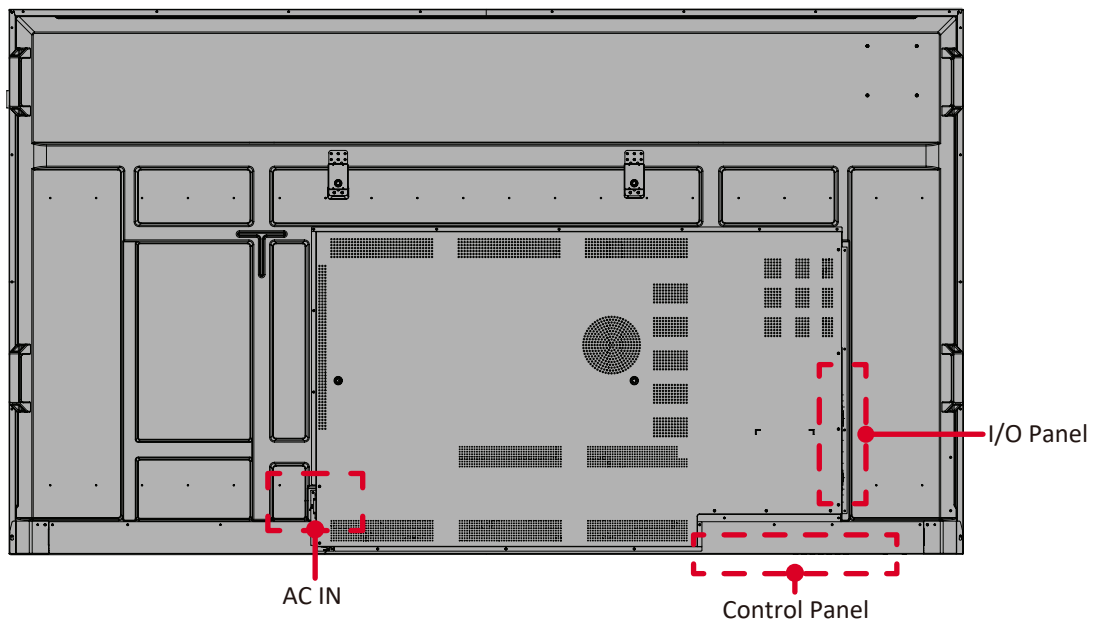

CDE98G3

Front View

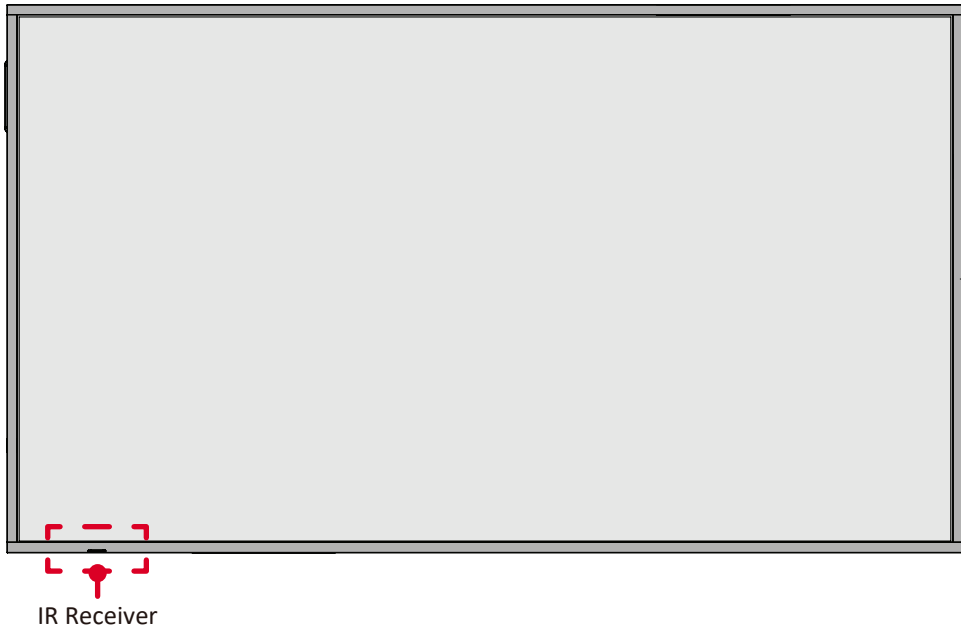

Rear View

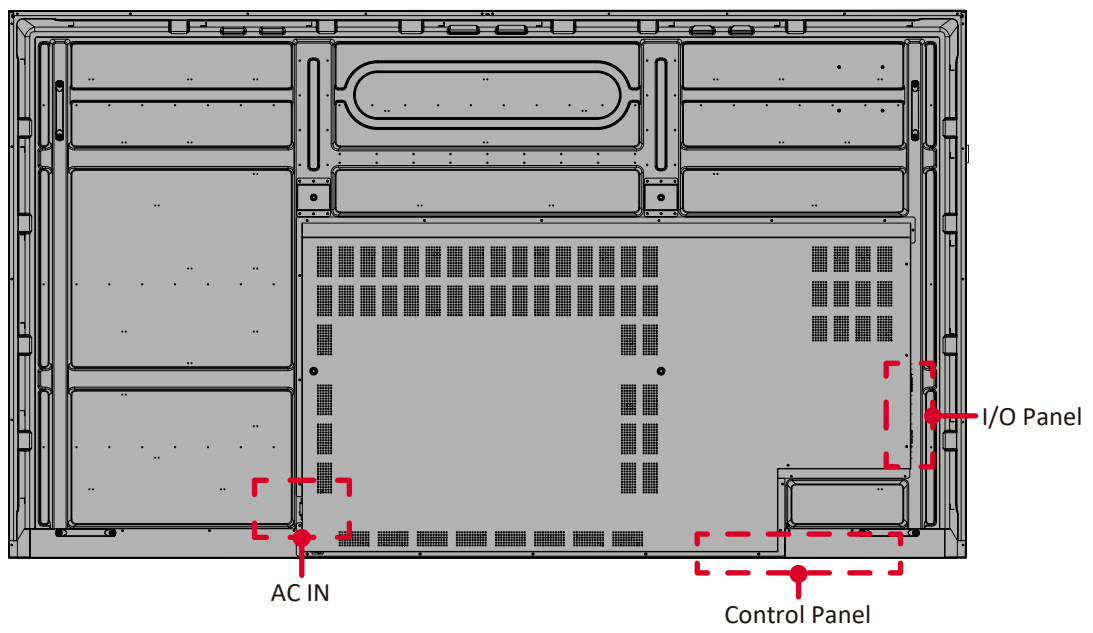

Control Panel

CDE43G3

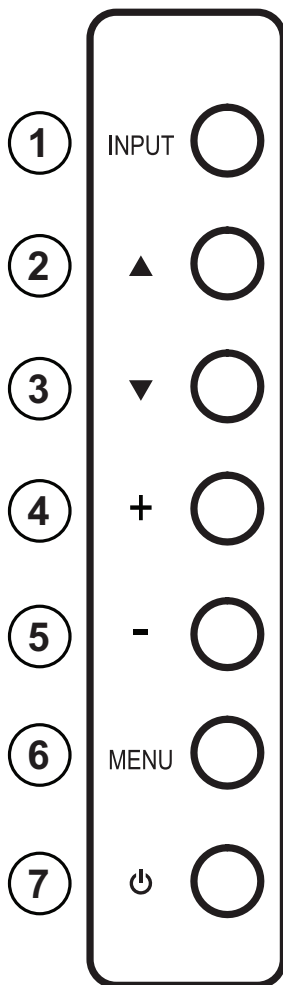

Button		Description
1	Input	<ul style="list-style-type: none">• Opens the input source menu.• Closes the input source menu.• Confirms the operation in the menu.
2	Up	In the On-Screen Display Menu, selects an item.
3	Down	In the On-Screen Display Menu, selects an item.
4	Volume Increase	<ul style="list-style-type: none">• Increases the volume level.• In the On-Screen Display Menu, adjusts the value of the selected item.
5	Volume Decrease	<ul style="list-style-type: none">• Decreases the volume level.• In the On-Screen Display Menu, adjusts the value of the selected item.
6	Menu	<ul style="list-style-type: none">• Opens the main menu.• Closes the main menu.
7	Power	Turns the display on or off.

CDE55G3 | CDE65G3 | CDE75G3 | CDE86G3 | CDE98G3

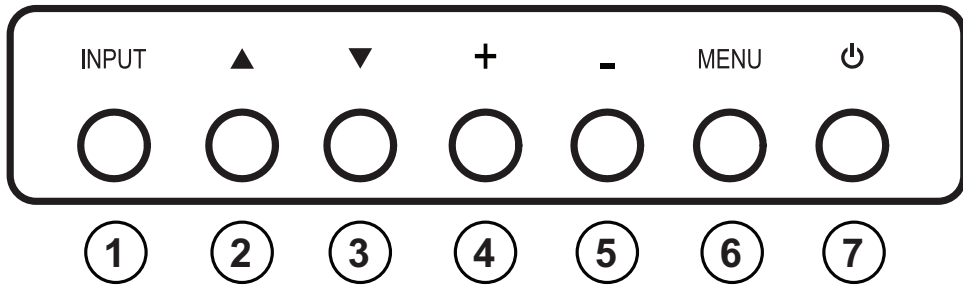

Button		Description
1	Input	<ul style="list-style-type: none"> • Opens the input source menu. • Closes the input source menu. • Confirms the operation in the menu.
2	Up	In the On-Screen Display Menu, selects an item.
3	Down	In the On-Screen Display Menu, selects an item.
4	Volume Increase	<ul style="list-style-type: none"> • Increases the volume level. • In the On-Screen Display Menu, adjusts the value of the selected item.
5	Volume Decrease	<ul style="list-style-type: none"> • Decreases the volume level. • In the On-Screen Display Menu, adjusts the value of the selected item.
6	Menu	<ul style="list-style-type: none"> • Opens the main menu. • Closes the main menu.
7	Power	Turns the display on or off.

I/O Panel

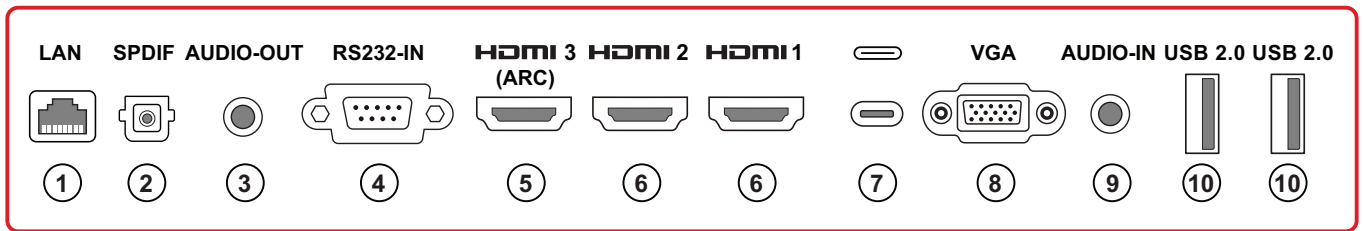

Port	Description
1	LAN Standard RJ45 (10M/100M) internet.
2	SPDIF Multichannel sound via optical signals.
3	AUDIO-OUT Audio output to an external speaker.
4	RS232-IN Serial interface used for mutual transfer of data between devices.
5	HDMI 3 <ul style="list-style-type: none"> • Supports 4K @ 60 Hz display; HDCP 2.2; CEC; ARC. • HDMI input. • Connect to a computer with HDMI output, set-top box, or other video device.
6	HDMI 1/2 <ul style="list-style-type: none"> • Supports 4K display; HDMI v. 2.0; HDCP 2.2; CEC. • HDMI input. • Connect to a computer with HDMI output, set-top box, or other video device.
7	 <ul style="list-style-type: none"> • USB Type C. • DisplayPort v. 1.2. • USB 2.0 standard. • For system update and media playback.
8	VGA External computer video input.
9	AUDIO-IN External computer audio input.
10	USB <ul style="list-style-type: none"> • USB Type A. • USB 2.0 standard. • For system update and media playback.

Remote Control

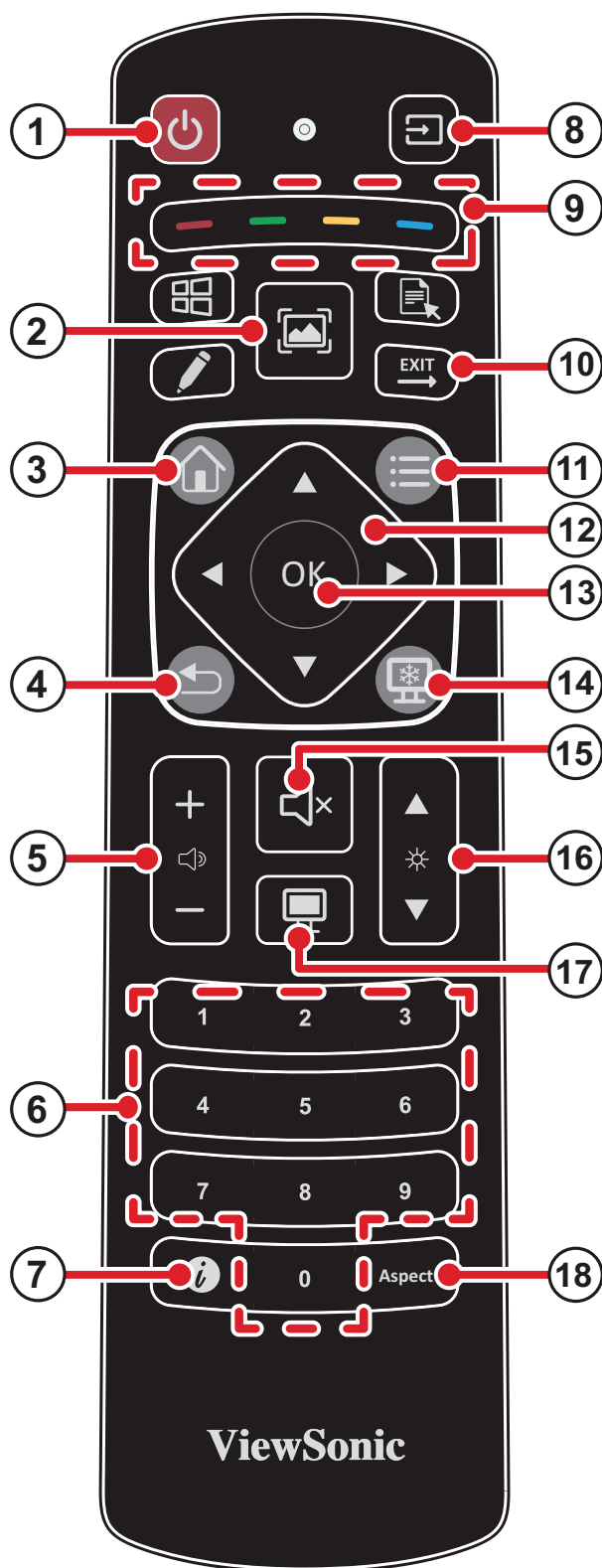

Button		Description	
1	Power	Turns the display on or off.	
2	Screenshot	<i>This button is unsupported.</i>	
3	Home	<i>This button is unsupported.</i>	
4	Return	Returns to the previous screen.	
5	Volume	Increases or decreases the volume level.	
6	Keypad	Number keypad.	
7	Information	Opens the information menu.	
8	Input Source	Selects the input source.	
9	Media Control	Red	Play/Pause
		Green	Stop
		Yellow	Next
		Blue	Previous
10	Exit	Closes the dialog box.	
11	Settings	Opens or closes the settings menu.	
12	Navigation	Selects an item or adjusts the value in the menu.	
13	OK	Confirms the selected item.	
14	Freeze	<i>This button is unsupported.</i>	
15	Mute	Stops audio output.	
16	Brightness	Increases or decreases the brightness level.	
17	Blank	<i>This button is unsupported.</i>	
18	Aspect Ratio	Changes the aspect ratio.	

Installing the Batteries

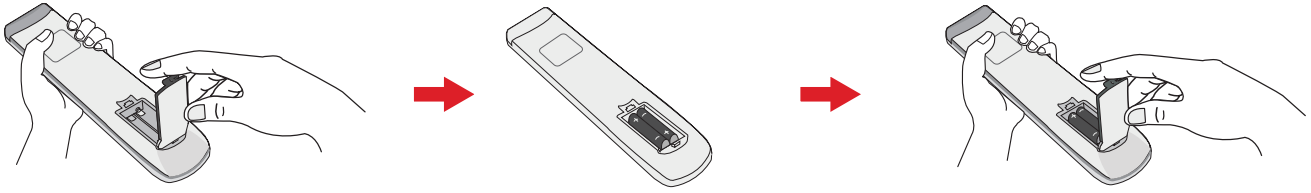

1. Open the battery compartment by removing the battery cover.
2. Insert two AAA batteries, ensuring correct polarity.
3. Replace the battery cover until it clicks into place.

Note:

- Store the remote control and batteries away from heat and humidity.
- Use only recommended battery types.
- Remove batteries when not in use for extended periods.
- Dispose of old batteries following the manufacturer's instructions and local regulations.

Receiver Range



The working range of the remote control is shown here. It has an effective range of 10 m (32.81 ft) in a straight line, 15 degrees left and right at 8 m (26.25 ft). Ensure there is nothing obstructing the remote control's signal to the receiver.

Making Connections

Connecting to Power

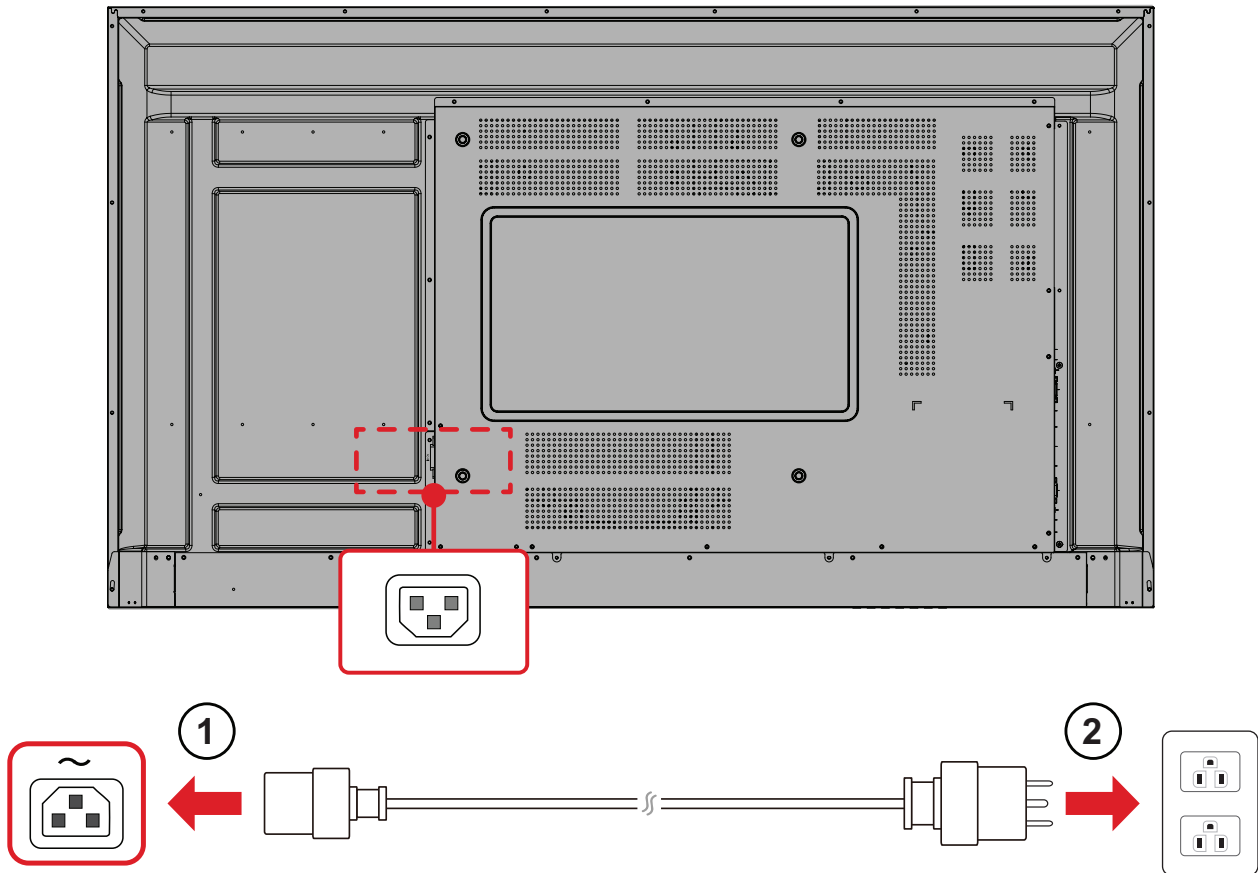

1. Connect the power cord to the **AC IN** jack at the rear of the display.
2. Plug the power cord plug into a power outlet.

Connecting to External Devices

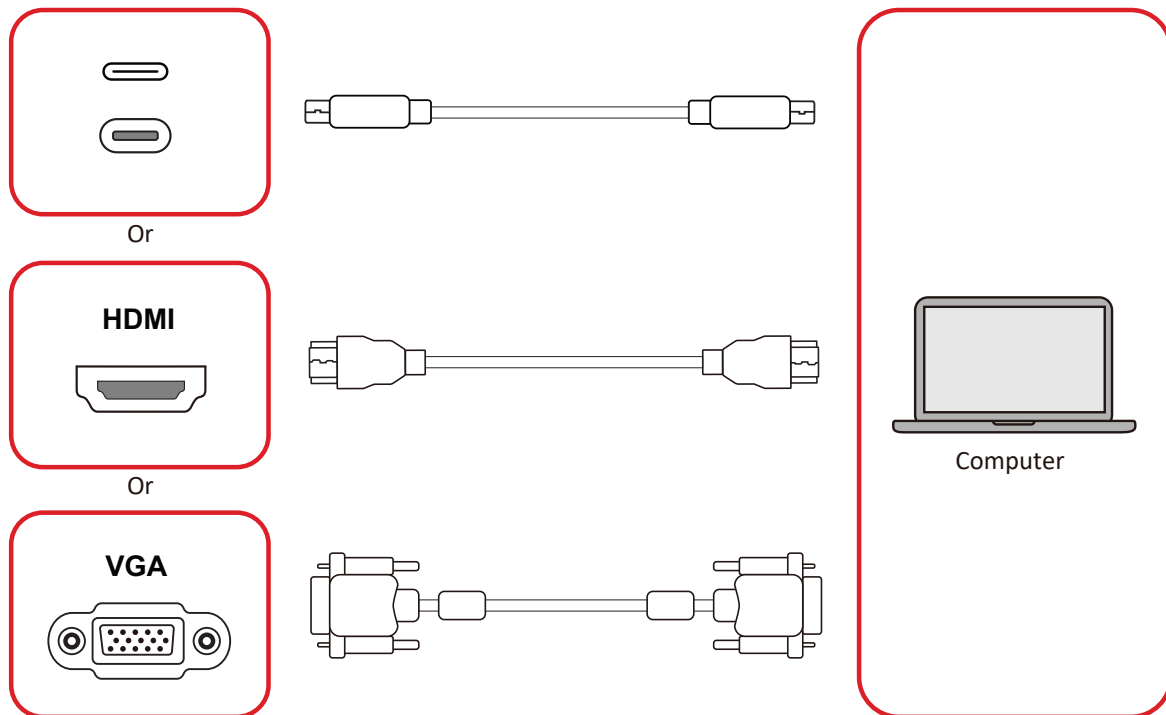

Your external device(s) can be connected in any of the following configurations:

USB Type C Connection

Connect a USB Type C cable from your external device to the USB Type C port on the display.

HDMI Connection

Connect an HDMI cable from your external device to the **HDMI 1/HDMI 2/HDMI 3** port on the display.

VGA Connection

Connect a VGA cable from your external device to the **VGA** port on the display.

RS-232 Connection

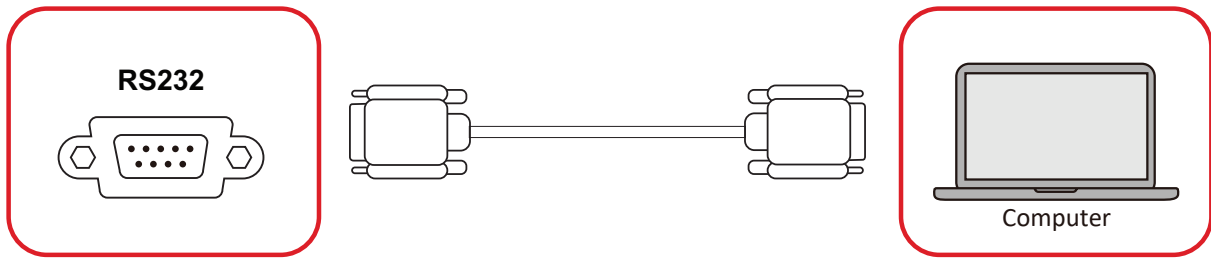

When you use a RS-232 serial cable to connect the display to an external computer or control system, certain functions can be controlled remotely such as: power on and off, volume adjustment, input select, brightness, and more.

USB Connection

The USB Type A and Type C ports only support system updates and media playback.

Note: The USB ports only support the FAT32 file system.

USB Type A

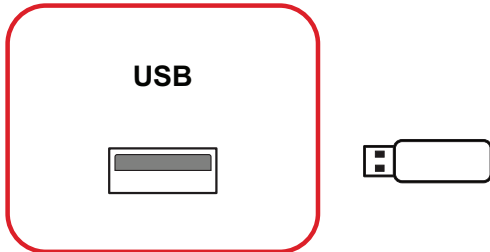

Plug the USB device into a USB Type A port of the display.

USB Type C

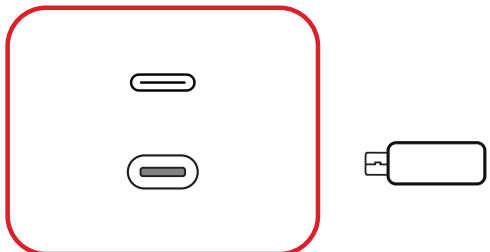

Plug the USB device into the USB Type C port of the display.

Network Connection



To connect to a local network, connect an Ethernet cable to your network, then connect the other end to the **LAN** port of the display.

Audio Connections

Audio In



To play audio from your external device, connect one end of an audio cable to your external device, and the other end to the **AUDIO IN** port of the display.

Audio Out



To play audio from the display through an external speaker, connect one end of an audio cable to the external speaker, and the other end to the **AUDIO OUT** port of the display.

SPDIF

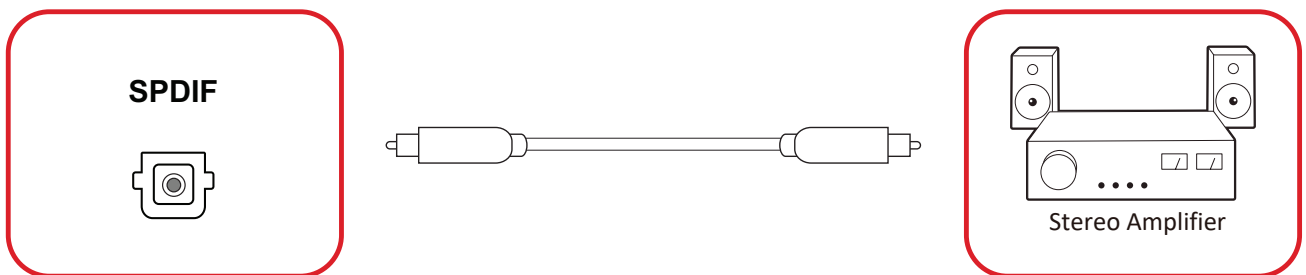

To connect to an external sound system, connect an optical cable from the display's **SPDIF** port to your sound system's optical connector.

Using Your Display

Turning the Display On/Off

1. Ensure the power cord is connected, plugged into a power outlet, and the power supply switch is in the “On” position.

Note: The power supply switch is located at the bottom of the display.

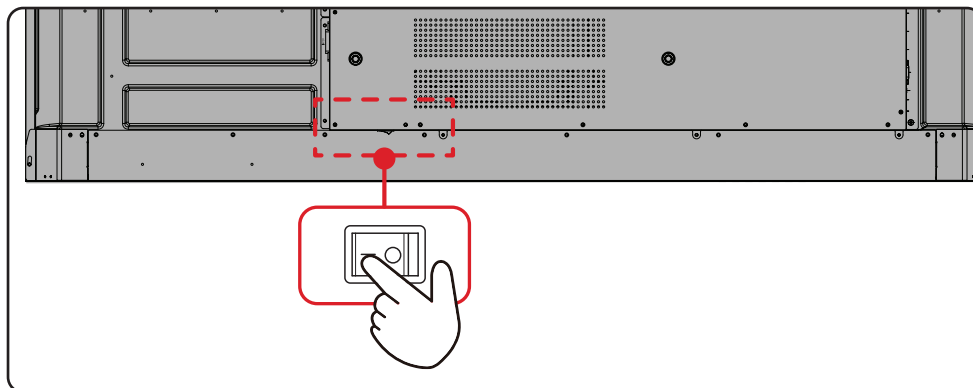

2. Press the **Power** button on the display or the remote control to turn on the display.

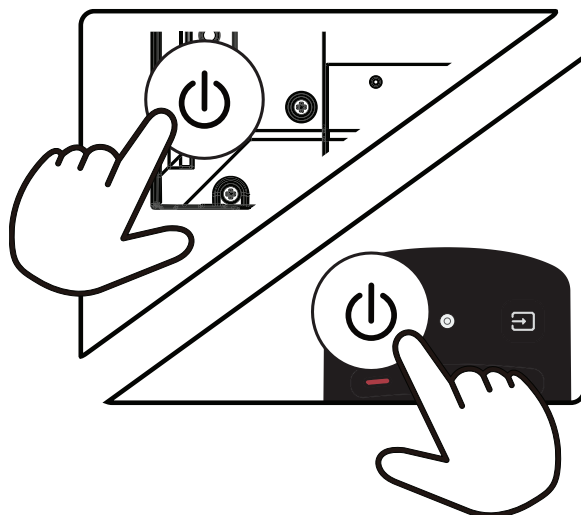

3. To turn the display off, press and hold the **Power** button.

On-Screen Display Menu

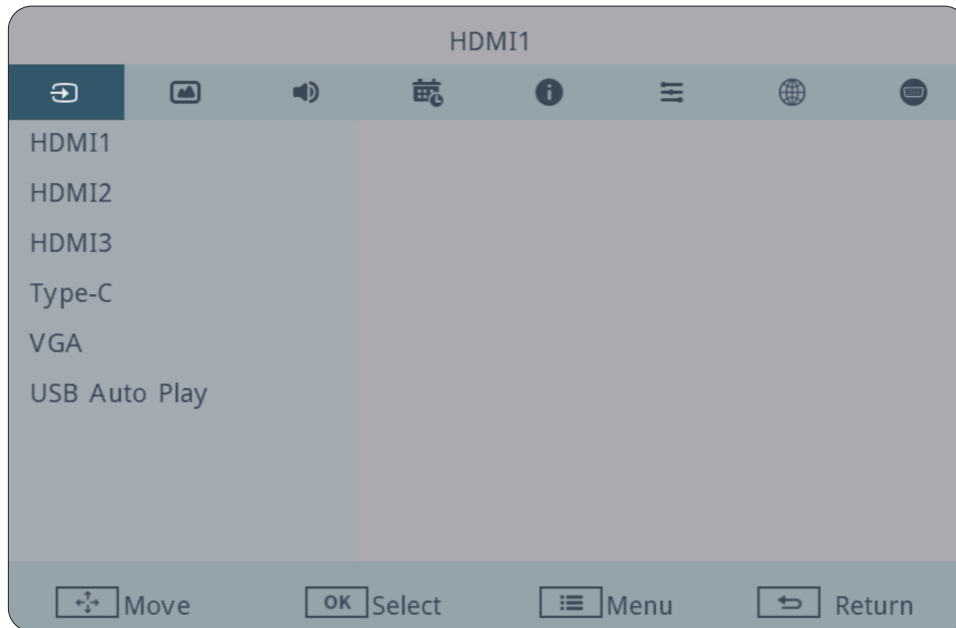

To open and operate the On-Screen Display Menu:

1. Press the **Settings** button on the remote control.
2. Press the **Navigation** buttons ($\downarrow/\uparrow/\leftarrow/\rightarrow$) on the remote control to select menu items or adjust values.
3. Press the **OK** button to confirm your selection.
4. Press the **Return** button to go back to the previous menu level.
5. Press the **Settings** button again to exit.

Input Source

Select one of the available input sources.

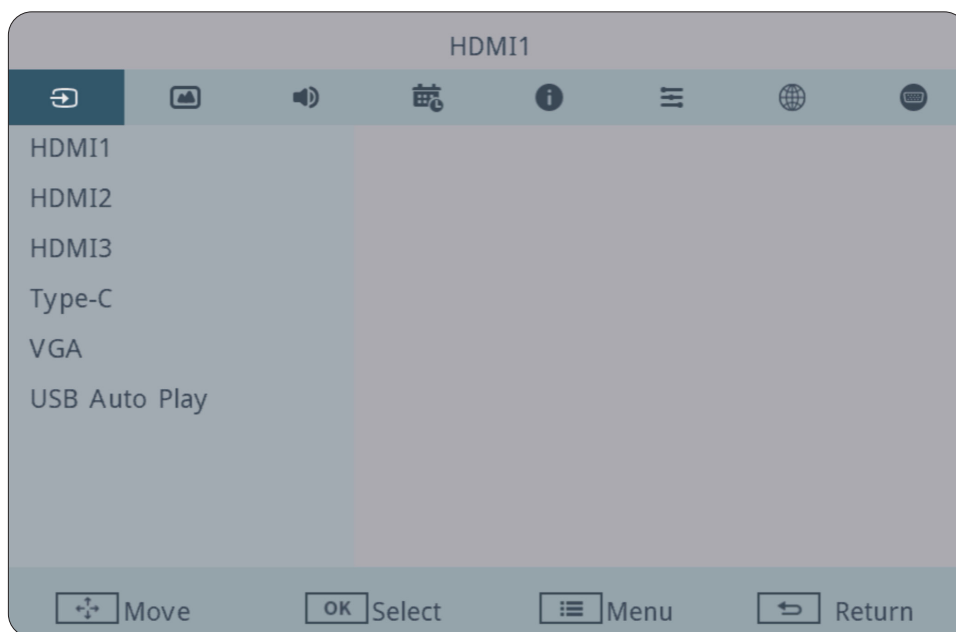

Picture

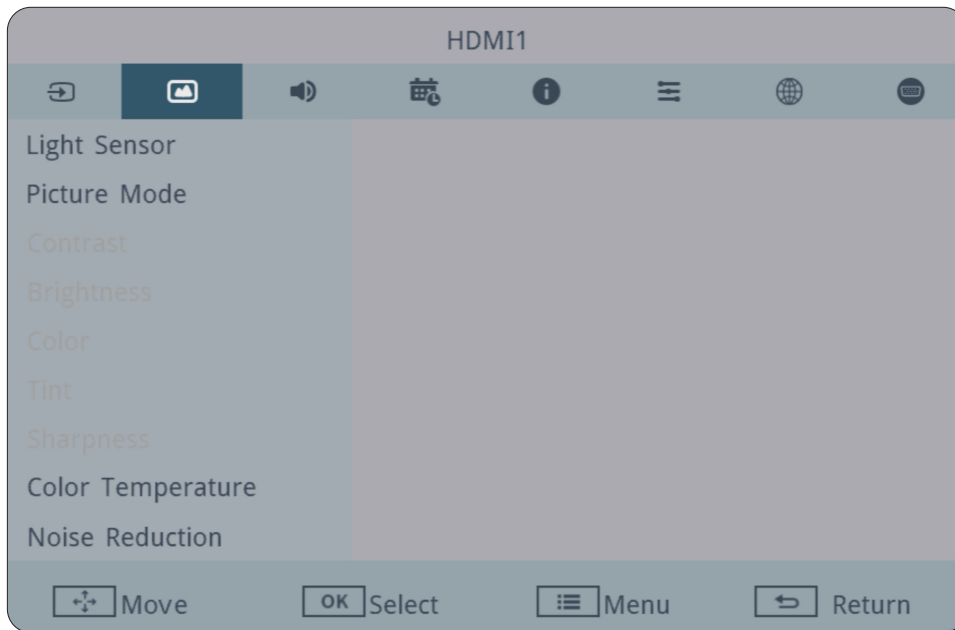

Item	Description
Light Sensor	Toggle the light sensor on or off.
Picture Mode	Select a predefined picture setting.
Contrast	Adjust the degree of difference between the lightest and darkest parts of the picture and change the amount of black and white in the image.
Brightness	Adjust the background black levels of the screen image.
Color	Adjust the amount of color present.
Tint	Adjust the lightness or darkness of the color shade.
Sharpness	Adjust the picture quality.
Color Temperature	Adjust the color temperature.
Color Temperature Scale	Adjust the color temperature scale.
Noise Reduction	Reduce image noise and distortion.
Overscan	Automatically enlarge the original picture horizontally and vertically to an equal aspect ratio that fills the screen.
RGB Range	Manually change the color format options to fit the correct color format range if the colors are not displayed correctly.
Blue Light Filter	Adjusts the filter that blocks high-energy blue light for a more comfortable viewing experience.

Item	Description
Gamma Set	Reflect the relationship between input source and picture brightness.
HDR10	Turn HDR support on or off.
Backlight	Adjust the backlight value.
Picture Reset	Return the Picture menu settings to their default values.

Audio

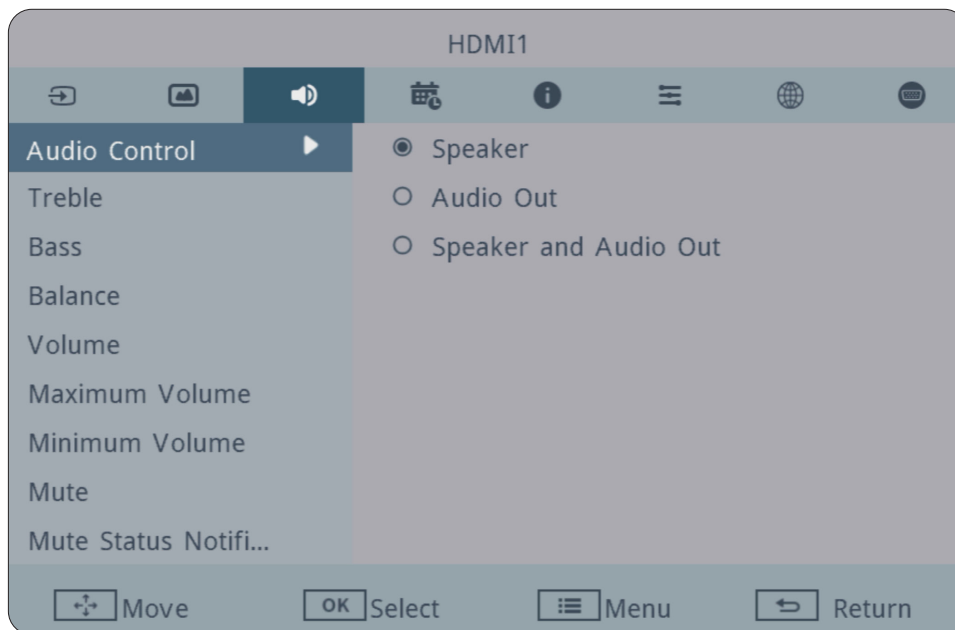

Item	Description
Audio Control	Select audio source from internal speaker or Audio Out port.
Treble	Increase or decrease the treble level (higher-pitched sounds).
Bass	Increase or decrease the bass level (lower-pitched sounds).
Balance	Adjust the left/right speaker balance.
Volume	Increase or decrease the display's volume level.
Maximum Volume	Set the display's maximum volume level.
Minimum Volume	Set the display's minimum volume level.
Mute	Mute the volume.
Mute Status Notification	Turn notifications on or off for the mute function.
Audio Out Sync	Sync Audio Out volume with the display's speakers.
Audio Out Volume (Line Out)	Increase or decrease the Audio Out volume.
ARC Audio	Increase or decrease the volume of the ARC audio.
Audio Reset	Return the Audio menu settings to their default values.

Time

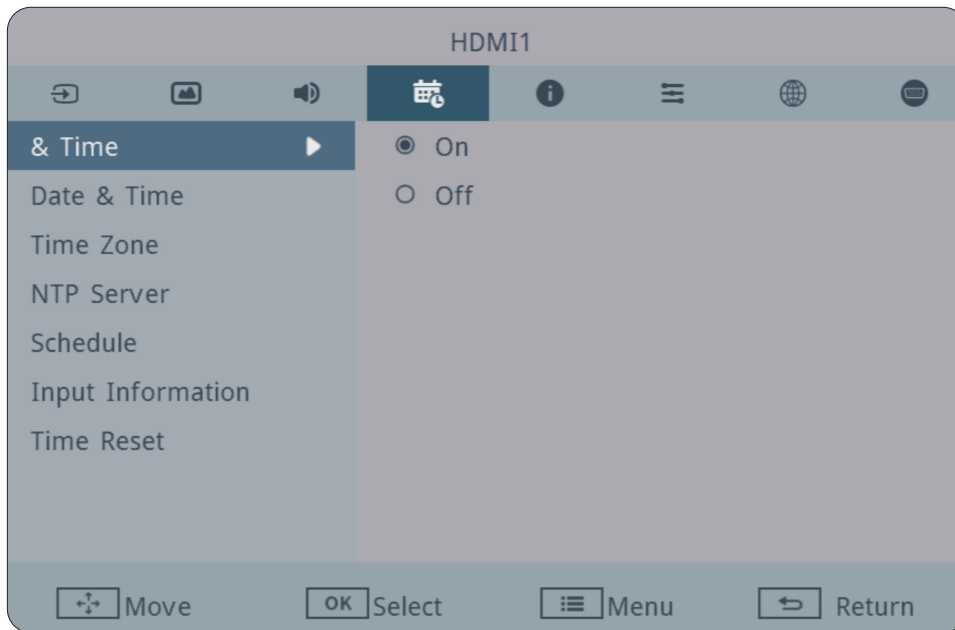

Item	Description	
Automatic Date & Time	Automatically set the date and time.	
Date & Time	Set the system time and format.	
Time Zone	Set the system time zone.	
NTP Server	Set the NTP server.	
Schedule	Schedule List	Set a schedule to turn on or off the display.
	Schedule Power On	Set the time to turn on the display.
	Schedule Power Off	Set the time to turn off the display.
	Input	The display will be turned on automatically when detecting an input signal.
	Interval	Set a day of the week to turn on the display automatically.
Input Information	Set the time period the input source information will be displayed in the upper left corner of the display.	
Time Reset	Return the Time menu settings to their default values.	

About

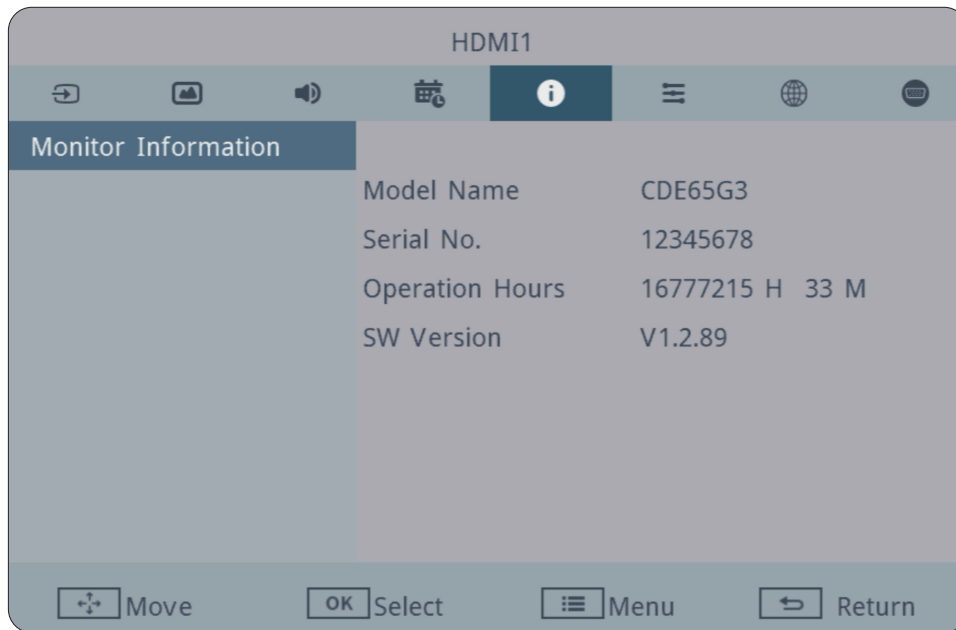

Item	Description
Monitor Information	See information about the display: Model Name, Serial No., Operation Hours, and Software Version.

Advanced

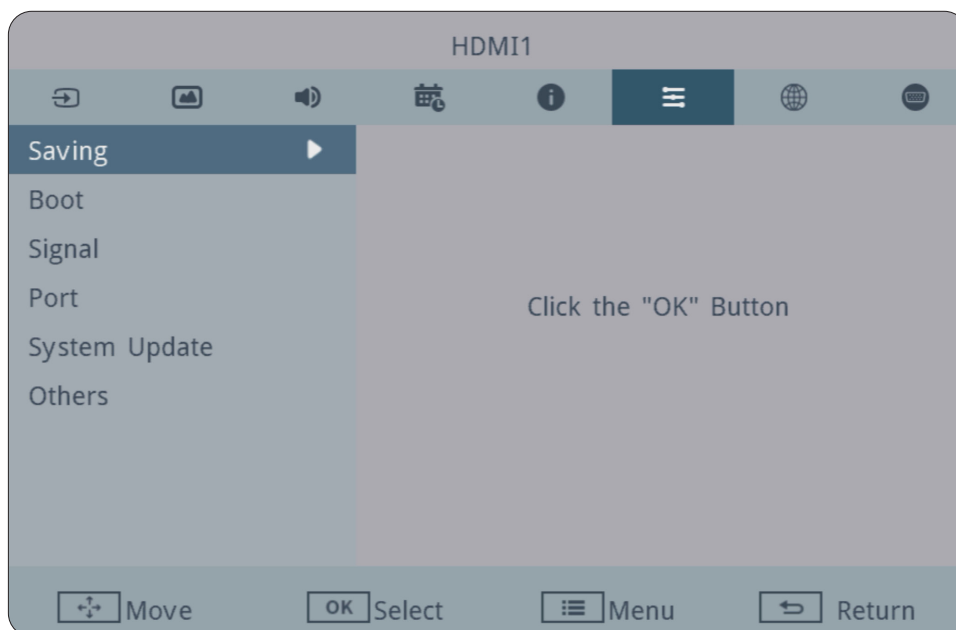

Item	Description		
Saving	Energy Star	Turn on or off Energy Star.	
	Off Time	Set a time for the display to automatically power off.	
	Panel Saving	Reduces the risk of image burn-in.	
	Pixel Shift	Reduce the possibility of screen burn-in. This setting allows the user to program the time between movements of the picture in minutes.	
	Power Save	Reduce power consumption.	
		Mode 1	TCP off, WOL on.
		Mode 2	TCP off, WOL on, wake up by video signal resume.
Mode 3		TCP on, WOL off, wake up by video signal resume.	
	Mode 4	TCP on, WOL off, no wake up by video signal resume support.	
Power LED Light	Turn on or off the Power LED indicator.		

Item	Description		
Boot	Boot On Source	Select the input source after boot up, including HDMI 1/2/3, USB Type C, VGA, Last Input (default), and USB Auto Play. Note: To learn more about USB Auto Play, see “USB Auto Play”.	
	Boot On Logo	Allow or don't allow a logo when the display is turned on.	
Signal	Auto Signal Detection	Let the display detect and display available input sources automatically.	
	No Signal Standby	Set the time period to enter Standby Mode when there is no signal.	
Port	HDMI CEC	Turn on or off CEC (Consumer Electronics Control). CEC synchronizes power on/off operation via HDMI connection. That is, if a device that also supports CEC is connected to the HDMI input of the display, when the display's power is turned off, the power of the connected device will also be turned off automatically. When the power of the connected device is turned on, the display's power will be turned on automatically.	
	USB Cloning	Import	Load the On-Screen Display Menu's settings from a USB storage device.
		Export	Save the On-Screen Display Menu's settings to a USB storage device.
	USB Auto Play	If turned on, the display will copy media files from the external USB storage device to the display's internal storage then play the media files automatically.	
System Update	Online Update	Manually check online for a new software version.	
	Local Update	Update the system from an external USB device.	

Item	Description	
Others	Input Source Rename	Set labels for each input source.
	Switch On State	Select the display status for the next time the power cord is connected to a power outlet.
	Wake On LAN	Turn on or off the Wake on LAN (WOL) feature.
	Monitor ID	Assign a number to remote control the display by RS-232. The number range is: 1~98; 99 is reserved for "All Displays".
	Orientation	Set the screen orientation - landscape or portrait.
	OSD Language	Select the menu language.
	OSD Turn Off	Set the time period the OSD Menu stays on the screen.
	Factory Reset	Return all On-Screen Display Menu settings to their default values.
	Advanced Option Reset	Return all Advanced menu settings to their default values.

USB Auto Play

When enabled, USB Auto Play copies media files from an external USB device to the display's internal storage and plays them sequentially after restarting the display.

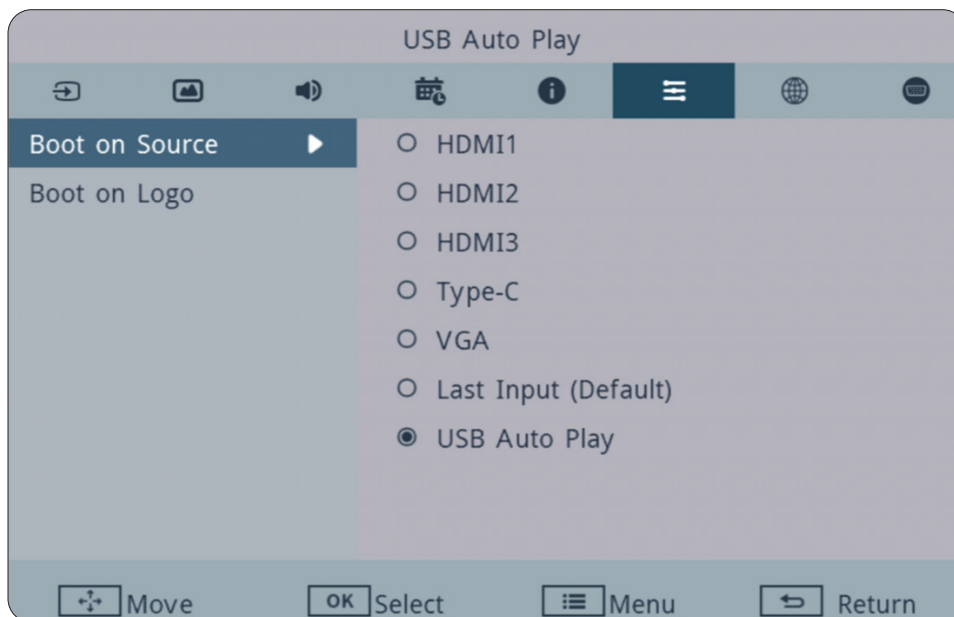

1. Plug a USB device that has media files (e.g., photos, music, or video) into a USB Type A port or the USB Type C port of the display.
2. In the **Advanced** menu, go to **Boot > Boot on Source > select USB Auto Play**. Press the **OK** button on the remote control to confirm.

Note:

- Photo: Each image displays for 5 seconds before the system advances to the next.
- Music: The system starts the next track after a 1-second delay following the previous track's completion.
- Movie: The system starts the next video after a 1-second delay following the previous video's completion.

Network

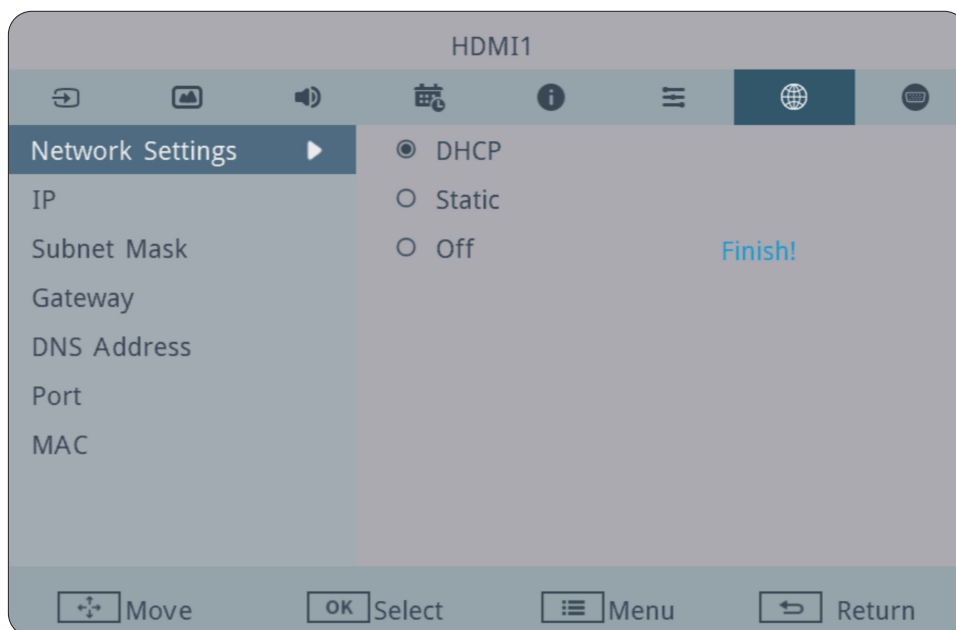

Item	Description
Network Settings	Set the network type - choose between DHCP, Static, or Off.
IP	View the current IP address.
Subnet Mask	View the Subnet Mask.
Gateway	View the Gateway address.
DNS Address	View the DNS address.
Port	View the current port number.
MAC	View the display's MAC address.

VGA

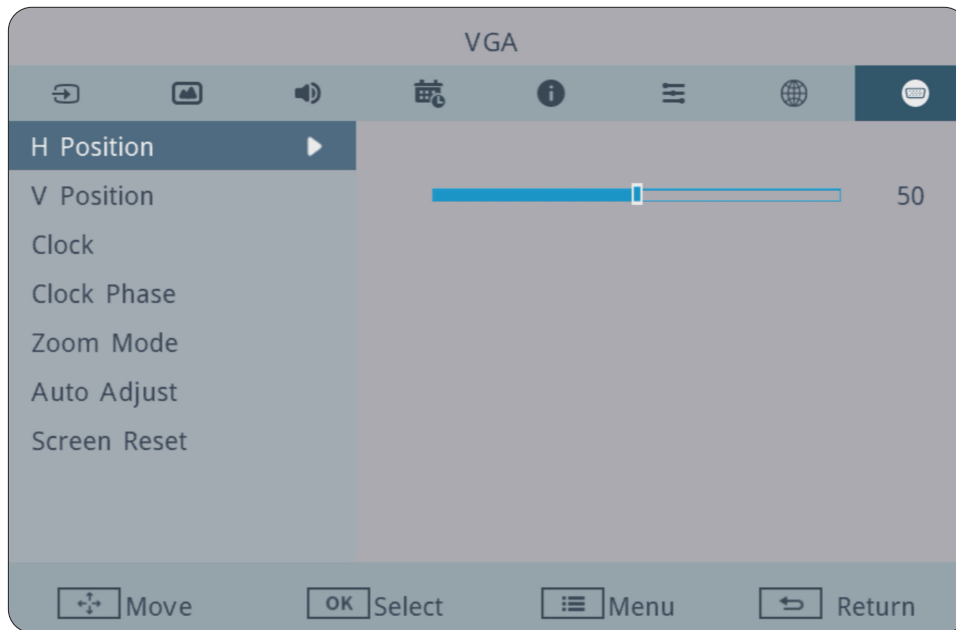

Item	Description
H Position	Adjust the screen image position horizontally.
V Position	Adjust the screen image position vertically.
Clock	Adjust the frequency of the pixel clock signal. This will affect the resolution and refresh rate.
Clock Phase	Adjust the clock phase to improve the display's clarity and avoid flickering.
Zoom Mode	Select the aspect ratio of the display.
Auto Adjust	Automatically adjust the position of the screen image.
Screen Reset	Reset the VGA settings to their default settings.

On-Screen Display Menu Tree

Main Menu	Sub-menu	Menu Option
Input Source	Input Source	
Picture	Light Sensor	Off
		On
	Picture Mode	Normal
		Dynamic
		Soft
		User
	Contrast	(-/+ , 0~100)/1
	Brightness	(-/+ , 0~100)/1
	Color	(-/+ , 0~100)/1
	Tint	(-/+ , 0~100)/1
	Sharpness	(-/+ , 0~100)/1
	Color Temperature	Warm
		Normal
		Cool
		User
	Color Temperature Scale	(-/+ , 0~100)/1
	Noise Reduction	Off
		Low
		Medium
		High
Overscan	Off	
	On	
RGB Range	Full Range	
	Limited Range	
	Auto	
Blue Light Filter	On	
	Off	

Main Menu	Sub-menu	Menu Option	
Picture	Gamma Set	Native	
		2.2	
		2.4	
		DICOM	
	HDR10	Off	
		On	
	Backlight	(-/+ , 0~100)/1	
Picture Reset			
Audio	Audio Control	Sync	Speaker
			Audio Out
	Treble	(-/+ , 0~100)/1	
	Bass	(-/+ , 0~100)/1	
	Balance	(-/+ , 0~100)/1	
	Volume	(-/+ , 0~100)/1	
	Maximum Volume	(-/+ , 0~100)/1	
	Minimum Volume	(-/+ , 0~100)/1	
	Mute	Off	
		On	
	Mute Status Notification	Off	
		On	
		3s show	
	Audio Out Sync	Off	
		On	
	Audio Out Volume (line out)	(-/+ , 0~100)/1	
ARC Audio	(-/+ , 0~100)/1		
Audio Reset			

Main Menu	Sub-menu	Menu Option		
Time	Automatic Date & Time	Off		
		On		
	Date and Time	Set Date		
		Set Time		
		Use 24-hour format		
	Time Zone			
	NTP Server			
	Schedule	Schedule		1~7
		Disable/Power On		
		Enable/Power Off		
		Input		HDMI 1
				HDMI 2
				HDMI 3
				Type C
				VGA
				USB Auto Play
		Interval		Monday
				Tuesday
				Wednesday
				Thursday
				Friday
				Saturday
				Sunday
Everyday				
Input Information	Off			
	5/10/20/30/60 seconds			
Time Reset				
About	Monitor Information	Model Name		
		Serial No.		
		Operation Hours		
		SW Version		

Main Menu	Sub-menu	Menu Option	
Advanced	Saving	Energy Star	Off
			On
		Off Time	Off
			10/20/30/60 /90/120/180/240 mins
			Off
		Panel Saving	Off
			On
		Pixel Shift	Off
			10/30/60/300/900 seconds
		Power Save	Mode 1
			Mode 2
			Mode 3
	Mode 4		
	Power LED Light	Off	
		On	
	Boot	Boot On Source	HDMI 1
			HDMI 2
			HDMI 3
			Type C
			VGA
			Last Input
			USB Auto Play
		Boot On Logo	Off
On			
Signal	Auto Signal Detection	Off	
		On	
	No Signal Standby	Off	
		1/5/15/30 min	

Main Menu	Sub-menu	Menu Option	
Advanced	Port	HDMI CEC	Off
			On
		USB Cloning	Import
			Export
		USB Auto Play	Off
			Photo
			Music
			Movie
		System Update	Online Update
	Local Update		
	Others	Input Source Rename	
		Switch on State	Power off
			Forced On
			Last Status
		Wake on LAN	Off
			On
		Monitor ID	1~98
		Orientation	Landscape
			Portrait
		OSD Language	English
			Arabic
			Catalan
			Czech
			Danish
			Dutch
	Finnish		
	French		
German			
Greek			
Hungarian			
Indonesian			
Italian			
Japanese			

Main Menu	Sub-menu	Menu Option	
Advanced	Others	OSD Language	Kazakh
			Korean
			Norwegian
			Polish
			Portuguese
			Portuguese (Brazil)
			Romanian
			Russian
			Simplified Chinese
			Slovenian
			Spanish
			Swedish
			Thai
			Traditional Chinese
			Turkish
		Ukrainian	
		Vietnamese	
OSD Turn Off	Off		
	5/15/30/60 seconds		
Factory Reset			
Advanced Option Reset			
Network	Network Settings	DHCP	
		Static	
		Off	
	IP		
	Subnet Mask		
	Gateway		
	DNS Address		
	Port		
	MAC		

Main Menu	Sub-menu	Menu Option		
VGA	H Position			
	V Position			
	Clock			
	Clock Phase			
	Zoom Mode			Full
				Normal (4:3)
				Real (1:1)
				Dynamic (16:9)
				21:9
	Auto Adjust			
Screen Reset				

RS-232 Protocol

This document describes the hardware interface spec and software protocols of the RS-232 interface communication between ViewSonic LFD and a PC or other control units with RS-232 protocol.

The protocol contains three command sections:

- Set-Function
- Get-Function
- Remote control pass-through mode

Note: Below, “PC” represents all the control units that can send or receive the RS-232 protocol command.

Description

RS-232 Hardware Specification

ViewSonic LFD communication port on the rear side:

1. Connector type: DSUB 9-Pin Male (female or 3.5 mm barrel connector)
2. Use of crossover (null modem) cable for connection
3. Pin Assignment:

Male DSUB 9-Pin
(preferred)

1 2 3 4 5



6 7 8 9

Female DSUB 9-Pin

5 4 3 2 1



9 8 7 6

3.5 mm barrel
connector (alternative
for limited space)



Pin #	Signal	Remark
1	NC	
2	RXD	Input to Display
3	TXD	Output from Display
4	NC	
5	GND	
6	NC	
7	NC	
8	NC	
9	NC	
frame	GND	

Item	Signal	Remark
Tip	TXD	Output from Display
Ring	RXD	Input to Display
Sleeve	GND	

LAN Hardware Specification

ViewSonic LFD communication port on the rear side:

1. Connector type: 8P8C RJ45
2. Pin Assignment:

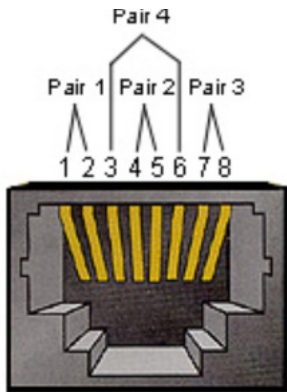

Pin #	Signal	Remark
1	TX+	Output from Display
2	TX-	Output from Display
3	RX+	Input to Display
4	BI_D3+	For 1G case
5	BI_D3-	For 1G case
6	RX-	Input to Display
7	BI_D4+	For 1G case
8	BI_D4-	For 1G case
frame	GND	

RS-232 Communication Setting

- Baud Rate Select: 9600bps (fixed)
- Data bits: 8 bits (fixed)
- Parity: None (fixed)
- Stop Bits: 1(fixed)

LAN Communication Setting

- Type: Ethernet
- Protocol: TCP/IP
- Port: 5000 (fixed)
- WOL Port: 9 (fixed) for UDP ^{*3.2.0}
- Cross subnet: No
- Logon Credentials: No

Command Message Reference

PC sends to LFD command packet followed by “CR”. Every time PC sends control command to Display, the Display shall respond as follows:

1. If the message is received correctly it will send “+” (02Bh) followed by “CR” (00Dh)
2. If the message is received incorrectly it will send “-” (02Dh) followed by “CR” (00Dh)

Protocol

Set-Function Listing

The PC can control the Display for specific actions. The Set-Function command allows you to control the Display behavior at a remote site through the RS-232 port. The Set-Function packet format consists of 9 bytes.

Set-Function Description:

- Length:** Total Byte of Message excluding "CR"

- LFD ID** Identification for each of Display (01~98; default is 01)
ID "99" means to apply the set command for all connected displays. Under such circumstances, only ID#1 display has to reply.
The LFD ID can be set via the OSD menu for each Display.

- Command Type** Identify command type,
"s" (0x73h): Set Command
"+" (0x2Bh): Valid command Reply
"- " (0x2Dh): Invalid command Reply

- Command:** Function command code: One byte ASCII code.

- Value[1~3]:** Three bytes ASCII that defines the value.

- CR** 0x0D

Set-Function Format

Send: (Command Type="s")

Name	Length	ID	Command Type	Command	Value1	Value2	Value3	CR
Byte Count	1 Byte	2 Byte	1 Byte	1 Byte	1 Byte	1 Byte	1 Byte	1 Byte
Bytes order	1	2~3	4	5	6	7	8	9

Reply: (Command Type="+" or "-")

Name	Length	ID	Command Type	CR
Byte Count	1 Byte	2 Byte	1 Byte	1 Byte
Bytes order	1	2~3	4	5

Note: When PC applies command to all displays (ID=99), only the #1 set needs to reply by the name of ID=1.

Example 1: Set Brightness as 76 for Display (#02) and this command is valid

Send (Hex Format)

Name	Length	ID	Command Type	Command	Value1	Value2	Value3	CR
Hex	0x38	0x30 0x32	0x73	0x24	0x30	0x37	0x36	0x0D

Reply (Hex Format)

Name	Length	ID	Command Type	CR
Hex	0x34	0x30 0x32	0x2B	0x0D

Example 2: Set Brightness as 75 for Display (#02) and this command is NOT valid

Send (Hex Format)

Name	Length	ID	Command Type	Command	Value1	Value2	Value3	CR
Hex	0x38	0x30 0x32	0x73	0x24	0x30	0x37	0x35	0x0D

Reply (Hex Format)

Name	Length	ID	Command Type	CR
Hex	0x34	0x30 0x32	0x2D	0x0D

Set-Function Table

A. Basic Function

Set Function	Length	ID	Command	Command		Value Range (Three ASCII bytes)	Comments
			Type (ASCII)	Code (ASCII)	Code (Hex)		
Power on *3.2.1/ off (standby)	8		s	!	21	000: STBY 001: ON	1. The Power-on via LAN control may works only under specific mode. To see display UG for details. *3.1.1 2. "WOL by MAC address" may available as alternative.*3.2.1
Input Select	8		s	"	22	004: HDMI1 014: HDMI2 024: HDMI 006: VGA 007: Slot-in PC (OPS) 009: DP 019: Type-C *3.2.4 00A: Embedded/ Main (Android)	1. No need for USB 2. For the case of two more same sources, the 2nd digital is used to indicate the extension. 3. The HEX of 00A is 30 30 41.
Brightness	8		s	\$	24	000 ~ 100 900: Bright down (-1) 901: Bright up (+1) *3.1.1	
Backlight *3.2.0	8		A	B	42	000 ~ 100	1. For Android platform whose main mode is controlled by backlight and the other sources are controlled by brightness. 2. Derived from Color calibration. *3.2.0
Power lock	8		s	4	34	000: Unlock 001: Lock	*See note in details
Volume	8		s	5	35	000 ~ 100 900: Volume down(-1) 901:Volume up(+1)	
Mute	8		s	6	36	000: OFF 001: ON (mute)	
Button lock	8		s	8	38	000: Unlock 001: Lock	*See note in details
Menu lock	8		s	>	3E	000: Unlock 001: Lock	*See note in details

Set Function	Length	ID	Command	Command	Value Range	Comments	
Number *3.1.1	8		s	@	40	000~009	
Key Pad *3.1.1	8		s	A	41	000: UP 001: DOWN 002: LEFT 003: RIGHT 004: ENTER 005: INPUT 006: MENU/(EXIT) 007: EXIT	
Remote Control	8		s	B	42	000: Disable 001: Enable 002: Pass through	Disable: RCU will be no function Enabled: RCU controls normally Pass through: Display will bypass the RC code to connected device via the RS-232 port, but not react itself.
Restore default	8		s	~	7E	000	Recover to factory setting

B. Optional Function

Set Function	Length	ID	Command		Value Range (Three ASCII bytes)	Comments	
			Type (ASCII)	Code (ASCII) Code (Hex)			
Contrast	8		s	#	23	000 ~ 100	
Sharpness	8		s	%	25	000 ~ 100	
Color	8		s	&	26	000 ~ 100	
Tint	8		s	'	27	000 ~ 100	
Backlight On_Off *3.2.3	8		s	(29	000: Off 001: On	
Color mode	8		s)	29	000: Normal 001: Warm 002: Cold 003: Personal	
Freeze On_Off *3.2.5	8		s	*	2A	000: Off 001: On	
Bass	8		s	.	2E	000 ~ 100	
Treble	8		s	/	2F	000 ~ 100	
Balance	8		s	0	30	000 ~ 100	050 is central
Picture Size	8		s	1	31	000: FULL (16:9) 001: NORMAL (4:3) 002: REAL (1:1) *3.1.0	
OSD language	8		s	2	32	000: English 001: French 002: Spanish	Could be extended for more supported languages by model
Date: Year	8		s	V	56	Y17~Y99	Last 2 digits (20)17~(20)99
Date: Month	8		s	V	56	M01~M12	2 digits
Date: Day	8		s	V	56	D01~D31	2 digits
Time: Hour	8		s	W	57	H00~H23	24-hr format. 2 digits.
Time: Min	8		s	W	57	M00~M59	2 digits
Time: Sec	8		s	W	57	S00~S59	2 digits
Customized Hot Keys *3.2.6	8		s	X	58	001~999 001: Open MVBA app *3.2.6	

Appendix

USB Media Supported Formats

Photo

File Extension	Format	Resolution	Note
.jpeg/jpg	JPEG	15360 x 8640	Baseline
		1024 x 768	Progressive
.png	PNG	1200 x 800	Non-interlaced
		9600 x 6400	Interlaced

Video

File Extension	Format	Resolution	Bit Rate	FPS
AVI (.avi)	MPEG-1	1920 x 1080	80 Mbps	30
	MPEG-2 MP@HL	1920 x 1080	40 Mbps	30
	H.264	3840 x 2160	100 Mbps(VCL)	30
	H263	1280 x 720	5 Mbps	30
	MJPEG	1920 x 1080	40 Mbps	30
MPEG (.mpeg)	MPEG-1	1920 x 1080	100 Mbps(VCL)	30
	MPEG-2 MP@HL	1920 x 1080	120 Mbps(NAL)	30
MPEG-4 Part 14 (.mp4)	H.264 MP, HP@Level 4.1	3840 x 2160	50 Mbps	30
			100 Mbps	
	MPEG-4 SP@L0-3, ASP@L0-5	1920 x 1080	100 Mbps(VCL)	30
	H265	3840 x 2160	20 Mbps(NAL)	30
QuickTime (.mov)	H.264 MP, HP@Level 4.1,	3840 x 2160	50 Mbps	30
	MPEG-4 SP@L0-3, ASP @ L0-5	1920 x 1080	100 Mbps	30
	MJPEG	1920 x 1080	100 Mbps(VCL)	30
	H265	3840 x 2160	120 Mbps(NAL)	30
Matroska (.mkv)	H.264 MP, HP@Level 4.1	3840 x 2160	100 Mbps	30
	H265	3840 x 2160	120 Mbps(NAL)	30

File Extension	Format	Resolution	Bit Rate	FPS
Flash Video (.flv)	H.264 MP, HP@Level 4.1	3840 x 2160	5 Mbps	30
			100 Mbps(VCL)	
DAT (.dat)	MPEG-1	1920 x 1080	45 Mbps	30
Advanced Stream Format (.asf)	VC1 (AP)	1920 x 1080	100 Mbps(VCL)	30
	H.264 MP, HP@Level 4.1	3840 x 2160	120 Mbps(NAL)	30
			50 Mbps	
MPEG-4 SP@L0-3, ASP	1920 x 1080	100 Mbps(VCL)	30	
3gp	H.264 MP, HP@Level 4.1,	3840 x 2160	120 Mbps(NAL)	30
			5 Mbps	
	H263	1280 x 720	50 Mbps	30
	MPEG-4 SP@L0-3, ASP @ L0-5	1920 x 1080	40 Mbps	30
tp	MPEG-2 MP@HL	1920 x 1080	80 Mbps	30
trp	H.264 MP, HP@Level 4.1	3840 x 2160	100 Mbps(VCL)	30
			120 Mbps(NAL)	
	MPEG-2 MP@HL	1920 x 1080	80 Mbps	30

Audio

File Extension	Format	Sample Rate	Bit Rate
MPEG Audio Layer III (.mp3)	MPEG	32 kHz ~ 48 kHz	32 kbps ~ 320 kbps
Wave Audio Files (.wav)	PCM	max 48 kHz	max 320 Kbps
	ADPCM	8 KHz ~ 48 KHz	384 Kbps
OGG Vorbis (.ogg)	Vorbis	8 kHz~48 kHz	max 320 Kbps
Free Lossless Audio Codec (.flac)	FLAC	max 48 kHz	max 320 Kbps

Timing Table

Graphic Resolution

HDMI PC | Type C

Resolution	Refresh Rate (V Frequency/Hz)	H Frequency (kHz)	Pixel Rate (MHz)	Stand for Mode
640 x 480	60	31.5	25.175	VESA
800 x 600	56	35.2	36.000	VESA
	60	37.9	40.000	VESA
1024 x 768	60	48.4	65.000	VESA
1280 x 768	60	47.4	68.250	KTCRB
	60	47.8	79.500	VESA
1280 x 800	60	49.7	83.500	VESA
1280 x 960	60	60.0	108.000	VESA
1280 x 1024	60	64.0	108.000	VESA
1360 x 768	60	47.7	85.500	VESA
1440 x 900	60	55.5	88.750	KTCRB
	60	55.9	106.500	KTC
1680 x 1050	60	65.3	146.250	VESA
1920 x 1080	60	67.5	148.500	CEA

VGA

Resolution	Refresh Rate (V Frequency/Hz)	H Frequency (kHz)	Pixel Rate (MHz)	Stand for Mode
640 x 480	75	31.5	25.175	VESA
800 x 600	60	37.9	40.000	VESA
	75	46.9	49.500	VESA
1024 x 768	60	35.5	44.900	CVT
1280 x 1024	75	80.0	135.00	VESA
1920 x 1080	75	80.0	135.000	CEA

HD Resolution

HDMI

Video	Resolution	Refresh Rate (V Frequency/ Hz)	H Frequency (kHz)	Pixel Rate (MHz)	Stand for Mode
480p	720 x 480	60	31.469	27	CEA
		60	31.469	27	CEA
576i	720 x 576	50	15.625	27	CEA
576p	720 x 576	50	31.250	27	CEA
720p	1280 x 720	50	31.25	74.25	CEA
		60	37.5	74.176	CEA
	1280 x 1080	50	45	74.25	CEA
1080i	1920 x 1080	60	31.25	72	CEA
		60	33.72	74.18	CEA
		60	33.75	74.25	CEA
1080p	1920 x 1080	24	27	74.18	CEA
		24	27	74.25	CEA
		25	28.125	74.25	CEA
		30	33.72	74.18	CEA
		30	33.75	74.25	CEA
		50	56.25	148.5	CEA
		60	67.5	148.5	CEA
4K	3840 x 2160	23.982	54	297	CEA
		25	56.25	297	CEA
		29.97	67.5	297	CEA
		50	112.5	594	CEA
		60	135	594	CEA

Type C

Video	Resolution	Refresh Rate (V Frequency/ Hz)	H Frequency (kHz)	Pixel Rate (MHz)	Stand for Mode
480p (4:3)	640 x 480	59.94	31.469	25.175	CEA
		60	31.5	25.2	CEA
	720 x 480	60	31.5	27.027	CEA
		1440 x 480	60	31.5	54.054
480p (16:9)	720 x 480	60	31.5	27.027	CEA
	1440 x 480	59.94	31.469	54	CEA
		60	31.5	54.054	CEA
576p (4:3)	720 x 576	50	31.25	27	CEA
576p (16:9)	720 x 576	50	31.25	27	CEA
	1440 x 576	50	31.25	54	CEA
720p (16:9)	1280 x 720	50	37.5	74.25	CEA
		59.939	44.955	74.175	CEA
		60	45	74.25	CEA
1080p (16:9)	1920 x 1080	23.976	26.973	74.175	CEA
		24	27	74.25	CEA
		25	28.125	74.25	CEA
		29.97	33.716	74.175	CEA
		30	33.75	74.25	CEA
		50	56.25	148.5	CEA
		59.939	67.432	148.35	CEA
		60	67.5	148.5	CEA
4K	3840 x 2160	23.982	54	297	CEA
		25	56.25	297	CEA
		29.97	67.5	297	CEA
		50	112.5	594	CEA
		60	135	594	CEA

Troubleshooting

This section describes some common problems that you may experience when using the display.

Problem or Issue	Possible Solutions
Remote Control is not working	<ol style="list-style-type: none">1. Check whether something is obstructing the display's remote control receiver.2. Check whether the batteries in the remote control are installed correctly.3. Check whether the batteries need to be replaced.
The unit turns off unexpectedly	<ol style="list-style-type: none">1. Check whether Sleep mode is enabled.2. Check if there is a power outage in your area.3. Turn on the display and see if the problem is with the signal and control system.

PC Mode

Problem or Issue	Possible Solutions
No PC signal	<ol style="list-style-type: none">1. Check the display settings.2. Check the display resolution.3. Adjust the Hs & Vs (synchronization) settings using the OSD menu.
Background streaking	<ol style="list-style-type: none">1. Choose auto adjust.2. Adjust clock and phase.
False color	<ol style="list-style-type: none">1. Check the connection.2. Adjust the chroma, brightness, and contrast settings.
Unsupported format	<ol style="list-style-type: none">1. Choose auto adjust.2. Adjust clock and phase settings.

Video Not Working Properly

Problem or Issue	Possible Solutions
No picture/ No sound	<ol style="list-style-type: none">1. Check the Power status.2. Check the signal cable.3. Check that the internal PC is installed correctly.
Picture is unclear or cuts in and out	<ol style="list-style-type: none">1. Check the signal cable.2. Check if other electronics are interrupting the signal.
Poor picture	<ol style="list-style-type: none">1. Adjust chroma, brightness, and contrast settings in the menu.2. Check the signal cable.

Audio Not Working Properly

Problem or Issue	Possible Solutions
No sound	<ol style="list-style-type: none">1. Press the Mute button.2. Adjust the volume.3. Check the audio cable.
One speaker only	<ol style="list-style-type: none">1. Adjust the sound balance in the menu.2. Check the sound control panel settings of the computer.3. Check the audio cable.

Maintenance

General Precautions

- Make sure the device is turned off and the power cable is unplugged from the power outlet.
- Never spray or pour any liquid directly onto the screen or case.
- Handle the device with care, as a darker-colored device, if scuffed, may show marks more clearly than a lighter-colored device.
- Do not use the system continuously for long periods of time.

Cleaning the Screen

- Wipe the screen with a clean, soft, lint-free cloth. This removes dust and other particles.
- If the screen is still not clean, apply a small amount of non-ammonia, non-alcohol based glass cleaner onto a clean, soft, lint-free cloth; then wipe the screen.

Cleaning the Case

- Use a soft, dry cloth.
- If the case is still not clean, apply a small amount of non-ammonia, non-alcohol based, mild non-abrasive detergent onto a clean, soft, lint-free cloth, then wipe the surface.

Disclaimer

- ViewSonic® does not recommend the use of any ammonia or alcohol-based cleaners on the display screen or case. Some chemical cleaners have been reported to damage the screen and/or case of the device.
- ViewSonic® will not be liable for damage resulting from use of any ammonia or alcohol-based cleaners.

Note: If condensation appears between the glass and the panel, keep the display turned on until the moisture disappears.

Regulatory and Service Information

Compliance Information

This section addresses all connected requirements and statements regarding regulations. Confirmed corresponding applications shall refer to nameplate labels and relevant markings on the unit.

FCC Compliance Statement

This device complies with part 15 of FCC Rules. Operation is subject to the following two conditions: (1) this device may not cause harmful interference, and (2) this device must accept any interference received, including interference that may cause undesired operation. This equipment has been tested and found to comply with the limits for a Class B digital device, pursuant to part 15 of the FCC Rules.

These limits are designed to provide reasonable protection against harmful interference in a residential installation. This equipment generates, uses, and can radiate radio frequency energy, and if not installed and used in accordance with the instructions, may cause harmful interference to radio communications. However, there is no guarantee that interference will not occur in a particular installation. If this equipment does cause harmful interference to radio or television reception, which can be determined by turning the equipment off and on, the user is encouraged to try to correct the interference by one or more of the following measures:

- Reorient or relocate the receiving antenna.
- Increase the separation between the equipment and receiver.
- Connect the equipment into an outlet on a circuit different from that to which the receiver is connected.
- Consult the dealer or an experienced radio/TV technician for help.

Warning: You are cautioned that changes or modifications not expressly approved by the party responsible for compliance could void your authority to operate the equipment.

Industry Canada Statement

CAN ICES (B) / NMB (B)

CE Conformity for European Countries



The device complies with the EMC Directive 2014/30/EU and Low Voltage Directive 2014/35/EU.

The following information is only for EU-member states:

The mark shown to the right is in compliance with the Waste Electrical and Electronic Equipment Directive 2012/19/EU (WEEE). The mark indicates the requirement NOT to dispose of the equipment as unsorted municipal waste, but use the return and collection systems according to local law.

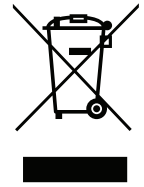

Declaration of RoHS2 Compliance

This product has been designed and manufactured in compliance with Directive 2011/65/EU of the European Parliament and the Council on restriction of the use of certain hazardous substances in electrical and electronic equipment (RoHS2 Directive) and is deemed to comply with the maximum concentration values issued by the European Technical Adaptation Committee (TAC) as shown below.

Substance	Proposed Maximum Concentration	Actual Concentration
Lead (Pb)	0.1%	< 0.1%
Mercury (Hg)	0.1%	< 0.1%
Cadmium (Cd)	0.01%	< 0.01%
Hexavalent Chromium (Cr6 ⁺)	0.1%	< 0.1%
Polybrominated biphenyls (PBB)	0.1%	< 0.1%
Polybrominated diphenyl ethers (PBDE)	0.1%	< 0.1%
Bis (2-ethylhexyl) phthalate (DEHP)	0.1%	< 0.1%
Butyl benzyl phthalate (BBP)	0.1%	< 0.1%
Dibutyl phthalate (DBP)	0.1%	< 0.1%
Diisobutyl phthalate (DIBP)	0.1%	< 0.1%

Certain components of products as stated above are exempted under the Annex III of the RoHS2 Directives as noted below. Examples of exempted components are:

- Copper alloy containing up to 4% lead by weight.
- Lead in high melting temperature type solders (i.e. lead-based alloys containing 85% by weight or more lead).
- Electrical and electronic components containing lead in a glass or ceramic other than dielectric ceramic in capacitors, e.g. piezoelectronic devices, or in a glass or ceramic matrix compound.
- Lead in dielectric ceramic in capacitors for a rated voltage of 125 V AC or 250 V DC or higher.

ENERGY STAR Statement

ENERGY STAR is a U.S. Environmental Protection Agency voluntary program that helps businesses and individuals save money and protect our climate through superior energy efficiency. Products that earn the ENERGY STAR prevent greenhouse gas emissions by meeting strict energy efficiency criteria or requirements set by the U.S. Environmental Protection Agency.

As an ENERGY STAR Partner, ViewSonic is determined to meet the Energy star Guidelines and mark all certified models with the ENERGY STAR logo.

The following logo appears on all ENERGY STAR-certified models:



Note: The power management features significantly reduce energy consumption when the product is not in use. Power management allows the device to automatically enter a low power “sleep” mode after a defined period of inactivity. And the power management features also enter Sleep Mode or Off Mode within 5 minutes of being disconnected from a host computer. Please note any change in energy settings will increase energy consumption.

Indian Restriction of Hazardous Substances

Restriction on Hazardous Substances statement (India). This product complies with the “India E-waste Rule 2011” and prohibits use of lead, mercury, hexavalent chromium, polybrominated biphenyls or polybrominated diphenyl ethers in concentrations exceeding 0.1 weight % and 0.01 weight % for cadmium, except for the exemptions set in Schedule 2 of the Rule.

Product Disposal at End of Product Life

ViewSonic® respects the environment and is committed to working and living green. Thank you for being part of Smarter, Greener Computing. Please visit the ViewSonic® website to learn more.

USA & Canada:

<https://www.viewsonic.com/us/go-green-with-viewsonic>

Europe:

<https://www.viewsonic.com/eu/environmental-social-governance/recycle>

Taiwan:

<https://recycle.moenv.gov.tw/>

For EU users, please contact us for any safety/accident issue experienced with this product:

ViewSonic Europe Limited



Haaksbergweg 75
1101 BR Amsterdam
Netherlands



+31 (0) 650608655



EPREL@viewsoniceurope.com



<https://www.viewsonic.com/eu/>

Copyright Information

Copyright© ViewSonic® Corporation, 2025. All rights reserved.

Macintosh and Power Macintosh are registered trademarks of Apple Inc.

Microsoft, Windows, and the Windows logo are registered trademarks of Microsoft Corporation in the United States and other countries.

ViewSonic® and the three birds logo are registered trademarks of ViewSonic® Corporation.

VESA is a registered trademark of the Video Electronics Standards Association. DPMS, DisplayPort, and DDC are trademarks of VESA.

ENERGY STAR® is a registered trademark of the U.S. Environmental Protection Agency (EPA).

As an ENERGY STAR® partner, ViewSonic® Corporation has determined that this product meets the ENERGY STAR® guidelines for energy efficiency.

Disclaimer: ViewSonic® Corporation shall not be liable for technical or editorial errors or omissions contained herein; nor for incidental or consequential damages resulting from furnishing this material, or the performance or use of this product.

In the interest of continuing product improvement, ViewSonic® Corporation reserves the right to change product specifications without notice. Information in this document may change without notice.

No part of this document may be copied, reproduced, or transmitted by any means, for any purpose without prior written permission from ViewSonic® Corporation.

Customer Service

For technical support or product service, see the table below or contact your reseller.

Note: You will need the product's serial number.

Country/Region	Website	Country/Region	Website
Asia Pacific & Africa			
Australia	www.viewsonic.com/au/	Bangladesh	www.viewsonic.com/bd/
中国 (China)	www.viewsonic.com.cn	香港 (繁體中文)	www.viewsonic.com/hk/
Hong Kong (English)	www.viewsonic.com/hk-en/	India	www.viewsonic.com/in/
Indonesia	www.viewsonic.com/id/	Israel	www.viewsonic.com/il/
日本 (Japan)	www.viewsonic.com/jp/	Korea	www.viewsonic.com/kr/
Malaysia	www.viewsonic.com/my/	Middle East	www.viewsonic.com/me/
Myanmar	www.viewsonic.com/mm/	Nepal	www.viewsonic.com/np/
New Zealand	www.viewsonic.com/nz/	Pakistan	www.viewsonic.com/pk/
Philippines	www.viewsonic.com/ph/	Singapore	www.viewsonic.com/sg/
臺灣 (Taiwan)	www.viewsonic.com/tw/	ประเทศไทย	www.viewsonic.com/th/
Việt Nam	www.viewsonic.com/vn/	South Africa & Mauritius	www.viewsonic.com/za/
Americas			
United States	www.viewsonic.com/us	Canada	www.viewsonic.com/us
Latin America	www.viewsonic.com/la		
Europe			
Europe	www.viewsonic.com/eu/	France	www.viewsonic.com/fr/
Deutschland	www.viewsonic.com/de/	Қазақстан	www.viewsonic.com/kz/
Россия	www.viewsonic.com/ru/	España	www.viewsonic.com/es/
Türkiye	www.viewsonic.com/tr/	Україна	www.viewsonic.com/ua/
United Kingdom	www.viewsonic.com/uk/		

Limited Warranty

ViewSonic® Display

What the warranty covers:

ViewSonic® warrants its products to be free from defects in material and workmanship during the warranty period. If a product proves to be defective in material or workmanship during the warranty period, ViewSonic® will, at its sole option, and as your sole remedy, repair or replace the product with a similar product. Replacement Product or parts may include remanufactured or refurbished parts or components. The repair or replacement unit or parts or components will be covered by the balance of the time remaining on the customer's original limited warranty and the warranty period will not be extended. ViewSonic® provides no warranty for any third-party software whether included with the product or installed by the customer, installation of any unauthorized hardware parts or components (e.g. Projector Lamps). (Please refer to: "What the warranty excludes and does not cover" section).

How long the warranty is effective:

ViewSonic® displays are warranted for between 1 and 3 years, depending on your country of purchase, for all parts including the light source and for all labor from the date of the first consumer purchase.

Who the warranty protects:

This warranty is valid only for the first consumer purchaser.

What the warranty excludes and does not cover:

- Any product on which the serial number has been defaced, modified, or removed.
- Damage, deterioration, or malfunction resulting from:
 - » Accident, misuse, neglect, fire, water, lightning, or other acts of nature, unauthorized product modification, or failure to follow instructions supplied with the product.
 - » Repair or attempted repair by anyone not authorized by ViewSonic®.
 - » Damage to or loss of any programs, data, or removable storage media.
 - » Normal wear and tear.
 - » Removal or installation of the product.
- Software or data loss occurring during repair or replacement.

- Any damage of the product due to shipment.
- Causes external to the product, such as electric power fluctuations or failure.
- Use of supplies or parts not meeting ViewSonic's specifications.
- Failure of owner to perform periodic product maintenance as stated in the User Guide.
- Any other cause which does not relate to a product defect.
- Damage caused by static (non-moving) images displayed for lengthy periods of time (also referred to as image burn-in).
- Software - Any third-party software included with the product or installed by the customer.
- Hardware/Accessories/Parts/Components – Installation of any unauthorized hardware, accessories, consumable parts or components (e.g. Projector Lamps).
- Damage to, or abuse of, the coating on the surface of the display through inappropriate cleaning as described in the product User Guide.
- Removal, installation, and set-up service charges, including wall-mounting of the product.

How to get service:

- For information about receiving service under warranty, contact ViewSonic® Customer Support (Please refer to the "Customer Service" page). You will need to provide your product's serial number.
- To obtain warranty service, you will be required to provide: (a) the original dated sales slip, (b) your name, (c) your address, (d) a description of the problem, and (e) the serial number of the product.
- Take or ship the product, freight prepaid, in the original container to an authorized ViewSonic® service center or ViewSonic®.
- For additional information or the name of the nearest ViewSonic® service center, contact ViewSonic®.

Limitation of implied warranties:

There are no warranties, express or implied, which extend beyond the description contained herein including the implied warranty of merchantability and fitness for a particular purpose.

Exclusion of damages:

ViewSonic's liability is limited to the cost of repair or replacement of the product. ViewSonic® shall not be liable for:

- Damage to other property caused by any defects in the product, damages based upon inconvenience, loss of use of the product, loss of time, loss of profits, loss of business opportunity, loss of goodwill, interference with business relationships, or other commercial loss, even if advised of the possibility of such damages.
- Any other damages, whether incidental, consequential or otherwise.
- Any claim against the customer by any other party.
- Repair or attempted repair by anyone not authorized by ViewSonic®.

Effect of state law:

This warranty gives you specific legal rights, and you may also have other rights which vary from state to state. Some states do not allow limitations on implied warranties and/or do not allow the exclusion of incidental or consequential damages, so the above limitations and exclusions may not apply to you.

Sales outside the U.S.A. and Canada:

For warranty information and service on ViewSonic® products sold outside of the U.S.A. and Canada, contact ViewSonic® or your local ViewSonic® dealer.

The warranty period for this product in mainland China (Hong Kong, Macao, and Taiwan Excluded) is subject to the terms and conditions of the Maintenance Guarantee Card.

For users in Europe and Russia, full details of warranty provided can be found at: <http://www.viewsonic.com/eu/> under "Support/Warranty Information".

Mexico Limited Warranty

ViewSonic® Display

What the warranty covers:

ViewSonic® warrants its products to be free from defects in material and workmanship, under normal use, during the warranty period. If a product proves to be defective in material or workmanship during the warranty period, ViewSonic® will, at its sole option, repair or replace the product with a like product. Replacement product or parts may include remanufactured or refurbished parts or components & accessories.

How long the warranty is effective:

ViewSonic® LCD displays are warranted for between 1 and 3 years, depending on your country of purchase, for all parts including the light source and for all labour from the date of the first consumer purchase.

Who the warranty protects:

This warranty is valid only for the first consumer purchaser.

What the warranty excludes and does not cover:

- Any product on which the serial number has been defaced, modified or removed.
- Damage, deterioration, or malfunction resulting from:
 - » Accident, misuse, neglect, fire, water, lightning, or other acts of nature, unauthorized product modification, unauthorized attempted repair, or failure to follow instructions supplied with the product.
 - » Causes external to the product, such as electrical power fluctuations or failure.
 - » Use of supplies or parts not meeting ViewSonic®'s specifications.
 - » Normal wear and tear.
 - » Any other cause which does not relate to a product defect.
- Any product exhibiting a condition commonly known as “image burn-in” which results when a static image is displayed on the product for an extended period of time.
- Removal, installation, insurance, and set-up service charges.

How to get service:

For information about receiving service under warranty, contact ViewSonic® Customer Support (Please refer to the attached “Customer Service” page). You will need to provide your product’s serial number, so please record the product information in the space provided below on your purchase for your future use. Please retain your receipt of proof of purchase to support your warranty claim.

For Your Records

Product Name: _____ Model Number: _____

Document Number: _____ Serial Number: _____

Purchase Date: _____ Extended Warranty Purchase? _____ (Y/N)

If so, what date does warranty expire? _____

- To obtain warranty service, you will be required to provide (a) the original dated sales slip, (b) your name, (c) your address, (d) a description of the problem, and (e) the serial number of the product.
- Take or ship the product, in the original container packaging, to an authorized ViewSonic® service center.
- Round trip transportation costs for in-warranty products will be paid by ViewSonic®.

Limitation of implied warranties:

There are no warranties, express or implied, which extend beyond the description contained herein including the implied warranty of merchantability and fitness for a particular purpose.

Exclusion of damages:

ViewSonic®’s liability is limited to the cost of repair or replacement of the product.

ViewSonic® shall not be liable for:

- Damage to other property caused by any defects in the product, damages based upon inconvenience, loss of use of the product, loss of time, loss of profits, loss of business opportunity, loss of goodwill, interference with business relationships, or other commercial loss, even if advised of the possibility of such damages.
- Any other damages, whether incidental, consequential or otherwise.
- Any claim against the customer by any other party.
- Repair or attempted repair by anyone not authorized by ViewSonic®.

Contact Information for Sales & Authorized Service (Centro Autorizado de Servicio) within Mexico:	
Name, address, of manufacturer and importers: México, Av. de la Palma #8 Piso 2 Despacho 203, Corporativo Interpalmas, Col. San Fernando Huixquilucan, Estado de México Tel: (55) 3605-1099 http://www.viewsonic.com/la/soporte/index.htm	
NÚMERO GRATIS DE ASISTENCIA TÉCNICA PARA TODO MÉXICO: 001.866.823.2004	
Hermosillo: Distribuciones y Servicios Computacionales SA de CV. Calle Juárez 284 local 2 Col. Bugambilias C.P: 83140 Tel: 01-66-22-14-9005 E-Mail: disc2@hmo.megared.net.mx	Villahermosa: Compumantenimientos Garantizados, S.A. de C.V. AV. GREGORIO MENDEZ #1504 COL, FLORIDA C.P. 86040 Tel: 01 (993) 3 52 00 47 / 3522074 / 3 52 20 09 E-Mail: compumantenimientos@prodigy.net.mx
Puebla, Pue. (Matriz): RENTA Y DATOS, S.A. DE C.V. Domicilio: 29 SUR 721 COL. LA PAZ 72160 PUEBLA, PUE. Tel: 01(52).222.891.55.77 CON 10 LINEAS E-Mail: datos@puebla.megared.net.mx	Veracruz, Ver.: CONEXION Y DESARROLLO, S.A DE C.V. Av. Americas # 419 ENTRE PINZÓN Y ALVARADO Fracc. Reforma C.P. 91919 Tel: 01-22-91-00-31-67 E-Mail: gacosta@qplus.com.mx
Chihuahua: Soluciones Globales en Computación C. Magisterio # 3321 Col. Magisterial Chihuahua, Chih. Tel: 4136954 E-Mail: Cefeo@soluglobales.com	Cuernavaca: Compusupport de Cuernavaca SA de CV Francisco Leyva # 178 Col. Miguel Hidalgo C.P. 62040, Cuernavaca Morelos Tel: 01 777 3180579 / 01 777 3124014 E-Mail: aquevedo@compusupportcva.com
Distrito Federal: QPLUS, S.A. de C.V. Av. Coyoacán 931 Col. Del Valle 03100, México, D.F. Tel: 01(52)55-50-00-27-35 E-Mail : gacosta@qplus.com.mx	Guadalajara, Jal.: SERVICRECE, S.A. de C.V. Av. Niños Héroes # 2281 Col. Arcos Sur, Sector Juárez 44170, Guadalajara, Jalisco Tel: 01(52)33-36-15-15-43 E-Mail: mmiranda@servicrece.com
Guerrero Acapulco: GS Computación (Grupo Sesicomp) Progreso #6-A, Colo Centro 39300 Acapulco, Guerrero Tel: 744-48-32627	Monterrey: Global Product Services Mar Caribe # 1987, Esquina con Golfo Pérsico Fracc. Bernardo Reyes, CP 64280 Monterrey N.L. México Tel: 8129-5103 E-Mail: aydeem@gps1.com.mx
MERIDA: ELECTROSER Av Reforma No. 403Gx39 y 41 Mérida, Yucatán, México CP97000 Tel: (52) 999-925-1916 E-Mail: rrrb@sureste.com	Oaxaca, Oax.: CENTRO DE DISTRIBUCION Y SERVICIO, S.A. de C.V. Murguía # 708 P.A., Col. Centro, 68000, Oaxaca Tel: 01(52)95-15-15-22-22 Fax: 01(52)95-15-13-67-00 E-Mail: gpotai2001@hotmail.com
Tijuana: STD Av Ferrocarril Sonora #3780 L-C Col 20 de Noviembre Tijuana, Mexico	FOR USA SUPPORT: ViewSonic® Corporation 381 Brea Canyon Road, Walnut, CA. 91789 USA Tel: 800-688-6688 E-Mail: http://www.viewsonic.com



ViewSonic®