

## Important Safety Instructions

This product is a professional photographic equipment, to be operated by professional personnel only.

The following basic safety precautions must be followed when using this product:

All transport protective materials and packaging on the product must be removed before use.

1. Carefully read and fully understand the instruction manual before use and strictly follow the safety instructions. Failure to do so may result in death, serious injury, damage to the product, or other property damage.
2. High voltage exists when the flash is powered on. Internal capacitors will remain charged for some time after power off.
3. This product is a professional lighting fixture, children are prohibited from using it. Children must be closely supervised by adults when approaching the fixture, to prevent collisions with the fixture or unauthorized use that could cause personal injury.
4. This is not an ordinary lighting fixture and must not be used for general illumination. Anyone with a history of eye damage or sensitivity should avoid using this fixture or looking directly at it.
5. Extreme caution must be exercised when using it, do not touch high-temperature parts such as flash tubes and surrounding metal components to avoid burns.
6. Do not point the flash directly at the eyes (especially baby's eyes) under any circumstances, as this could impair vision in a short time. Turn off immediately if discomfort occurs, stop using, and seek medical attention promptly.
7. If the flash tube is damaged, stop using it immediately and contact the manufacturer, service agent, or qualified repair personnel for a replacement to prevent accidents.
8. Do not use damaged equipment or accessories. Allow professional repair technicians to inspect and confirm normal operation before continuing use after repairs.
9. Disconnect power source or remove batteries (if it has one) before replacing flash tube, protective glass, or fuses. Allowing 10 minutes to cool before replacing flash tube, and wear insulated or heat resistant gloves when operating.
10. Turn off power before connecting or disconnecting plugs from outlets. Ensure plugs are fully inserted when connecting.
11. Stop using immediately if the product shell is cracked due to falling, squeezing, or strong impact, to avoid touching the internal electronic components and getting an electric shock.
12. Some products have long power cords, please place them properly to avoid contact with heat sources or tripping others. It is recommended to use the original power cord. Damage caused by non-original cords is not covered by the warranty.
13. Unplug the equipment power plug from the power socket before cleaning or maintenance. Do not pull the power cord forcibly, use both hands to hold the plug end and pull it out.
14. This device is not waterproof. Keep it dry and avoid immersing it in water or other liquids. It should be installed in a ventilated and dry location and avoid using in rainy, humid, dusty, or overheated environments. Do not place items above the device or allow liquids to flow into it to prevent danger.
15. Do not disassemble without authorization. If the product malfunctions, it must be inspected and repaired by our company or authorized repair personnel.
16. Before storing the device, ensure it has completely cooled down and the power cord is unplugged, then put it in the protective case or a ventilated dry location.
17. Do not place the device near alcohol, gasoline, or other flammable volatile solvents or gases such as methane and ethane.

18. Do not use or store this device in potentially explosive environments.
19. Do not cover the heat dissipation port!
20. Do not use accessories not been approved by our company, as this may cause fire, electric shock or personal injury.
21. Clean gently with a dry cloth. Do not use a wet cloth as it may damage the device.
22. Some products are equipped with protective covers that must be removed before use.
23. This instruction manual is based on rigorous testing. Changes in design and specifications are subject to change without notice. Check official website for latest instruction manual and product updates.
24. Use only specified charger and follow proper usage instructions for certain products with built-in lithium batteries, within the rated voltage and temperature range.
25. Some products are powered by lithium batteries, who have limited lifespans , typically lasting 300-500 complete charge-discharge cycles. As usage frequency and duration increase, its maximum storage capacity will gradually decrease, which is a normal phenomenon. Please regularly check the battery, and if the charging time significantly increases or the battery life significantly decreases, consider replacing the battery.
26. Some products are equipped with lithium batteries. The following are the storage recommendations: Charge the battery to about 50% before storage. Charge it to about 50% at least every six months. Failure to perform maintenance charging over an extended period may cause the battery to suffer permanent performance degradation or even become unusable due to excessive discharge. Removable batteries should be stored separately. The storage temperature should be between 0°C and 40°C.  
Some products are powered by lithium batteries. Please note:
  - Do not disassemble, crush, or puncture the battery;
  - The battery is not waterproof, do not immerse it in fog or water;
  - Avoid short-circuiting the battery contacts;
  - Do not expose the battery to or put it into fire;
  - Do not expose the battery to temperatures above 60°C;
  - Keep out of reach of children;
  - Protect the battery from excessive shock or vibration;
  - Do not use a damaged battery;
  - If the battery leaks, avoid contact with the leaking fluid;
  - If the battery fluid comes into contact with your eyes, immediately rinse with water for at least 15 minutes. Lift your eyelids until there are no signs of fluid and seek medical attention promptly.
27. Confirm and comply with all relevant local laws and regulations when handling any batteries.
28. The warranty period for this device as a whole is one year. Consumables (such as batteries), adapters, power cords, and other accessories are not covered by the warranty.
29. Unauthorized repairs will void the warranty and will incur charges.
30. Failures from improper operation is not covered under warranty.

## **Warning**

1. Danger of explosion if the battery are not replaced properly, danger of fire or explosion if replaced with the wrong type of battery pack, replace only with battery of the same type or equivalent. Replace by service personnel only, not general personnel. Do not disassemble the product or disassemble the battery.
2. The battery must not be exposed to conditions such as sunlight, fire, or similar excessive heat. Do not expose to rain or water.
3. The Battery is not allowed to be disassembled, hit, crushed or thrown into fire. Do not continue to use if it is seriously inflated. Do not place in a high temperature environment. Do not use after immersion in water.
4. When using, it should be placed in a place where it is easy to dissipate heat, and should not be placed on the bedside, bedding, in a package or other environments that are not easy to dissipate heat. Keep out of contact with infants and young children, and children should use under adult guidance.

## Content

Foreword	31
Main Features	31
Name of Parts	32
What's Inside	34
Separately Sold Accessories	34
Installing and Disassembling Reflector/Flash Tube	35
Adjusting Flash Angle	36
Loading and Unloading the Battery	37
Battery Level Indication	38
Battery Instructions	39
Power Switch	40
TTL Auto Flash	40
M: Manual Flash	40
Multi: Stroboscopic Flash	43
High-Speed Sync	44
Wireless (2.4G) Transmission	45
Wireless Settings	45
Godox FT433 Function	48
Flash Mode	49
Modeling Lamp	49
MENU Settings	50
Sync Triggering	51
Protection Function	51
The Reason & Solution of Not Triggering in Godox 2.4G Wireless	53
Technical Data	54
Firmware Upgrade	55

## Foreword

Thank you for purchasing!

AD800Pro has strong power, detachable lithium battery pack and great portability. When using Godox 2.4G wireless X system, it can be triggered by XPro/XProII/X2T/X3 series flash trigger in M/Multi/TTL mode. With transmitter & receiver functions, AD800Pro can also use in combination with Godox camera flashes, outdoor flashes, studio flashes, etc. With this flash, your shooting will become simpler. With high-speed shooting throughout the process, single fixture overshadowing strong sunlight, bare flash tube and reflector make a perfect match for outdoor and live shooting, AD800Pro is an ideal light source for freelance commercial photographers, journalists, photography enthusiasts, wedding documentary photographers, etc.

## Main Features

- **Quick Recycle Time:** Approx.0.01s(minimum power)~1.5s(full power).
- **Stable Color Temperature:** shift around  $\pm 100\text{K}$  over the entire power range with this function.
- **LED Modeling Lamp:** 40W bi-color large LED modeling light freely adjusts brightness and CCT.
- **Studio Quality Light:** up to 800Ws, approx. 300 full power flashes on a single charge, 1/8000s high-speed sync.
- **Precise Power Adjustment:** from full power 1/1 to 1/512 with 0.1 increment each step.
- **Wide Compatibility:** fully support M, Multi and wireless TTL flash systems of Canon, Nikon, Fujifilm, OM SYSTEM, Sony, Leica, Pentax, etc. Workable as a receiver unit in a wireless flash group.
- **Wireless Control:** with built-in 2.4G wireless X system to achieve remote control by optional Godox flash triggers, and 3.5mm sync cord jack to achieve various sync triggering modes.
- **Distinct Group Colors:** 16 groups with different colors to quickly distinguish even in remote distance usage.
- **Simple Operation:** 2.8" color screen together with steplessly rotatable select dial, detachable battery pack design.
- **Wide-range Accessories:** Bowens mount has wide compatibility and versatility.

Note:

1. The fastest recycle time is based on Godox laboratory test results. After high-intensity continuous flashes, the system will automatically extend the recycle time for safe heat dissipation, which is a normal protection mechanism. Once the device cools down, it can return to peak recycle speed.
2. The number of flashes is based on testing results from the Godox laboratory. Actual usage may vary depending on battery condition, ambient temperature, and usage habits.



CAUTION

Hot surface.

Do not touch.

Burned fingers when handling the parts.

Wait one-half hour after switching off before handling parts.

## Name of Parts

### Flash Body

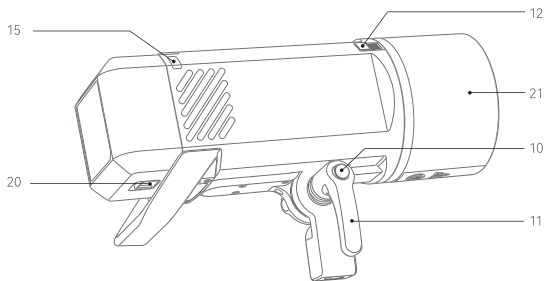
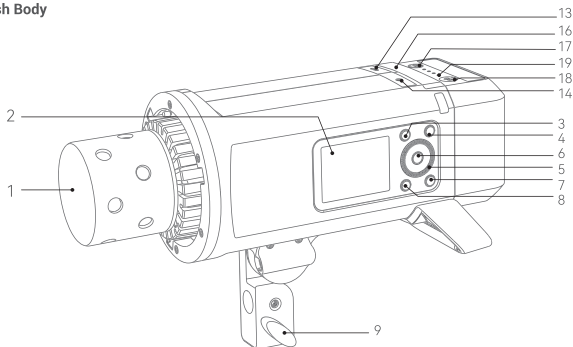

- |                             |  |                              |
|-----------------------------|--|------------------------------|
| 1. Flash Tube               | 9. Bracket Locking Knob                                | 16. Photocell Sensor         |
| 2. Color Screen             | 10. Handle Fixing Fastener                             | 17. Battery Indicator Button |
| 3. MENU Button              | 11. Handle   | 18. Battery Charging Port    |
| 4. MODE Button              | 12. Accessory Locking Pusher                           | 19. Battery Level Indicator  |
| 5. Select Dial              | 13. USB-C Port(firmware upgrade/insert FR433 receiver) | 20. Battery Detaching Pusher |
| 6. SET Button               | 14. 3.5mm Sync Cord Jack                               | 21. Reflector                |
| 7. Power Switch/Test Button | 15. Group Indicator ×2                                 |                              |
| 8. Modeling Lamp Button     |  |                              |

## Color Screen

### (1) TTL Auto Flash (only available in wireless on mode)

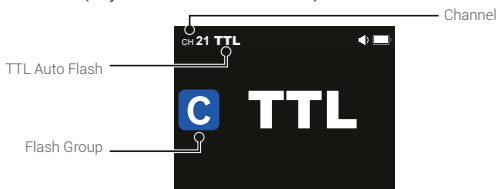

### (2) M (Manual) Flash



### (3) Multi Flash

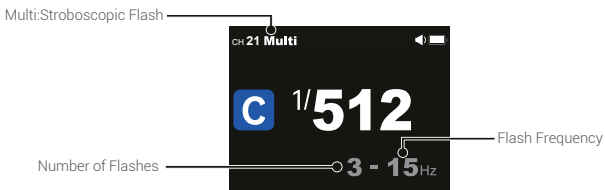

## What's Inside

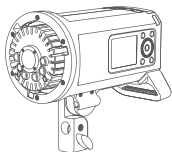

Flash Body × 1



Flash Tube × 1



Battery × 1



Adapter × 1



Power Cord × 1



Reflector Protection Cover × 1



Reflector × 1



Instruction Manual × 1

## Separately Sold Accessories

**Purchase more Godox accessories to achieve best photography effects:**

**Flash Head:** H600P Portable Flash Head

**Power Source:** AC26 AC Power Source, UC46USB Power Adapter

**Flash Trigger:** XPro, XProII, X2T, X3 series.

**Optical Accessories:** Umbrella Softbox, Collapsible Lantern Softbox, Quick-loading Parabolic Softbox, Beauty Dish, Umbrella Diffuser, Snoot, Light Stand, etc.

## Installing and Disassembling Reflector/Flash Tube

**Installing the Reflector:** Insert the reflector into the accessory mount, press and hold then rotate clockwise, the accessory locking pusher will lock up.

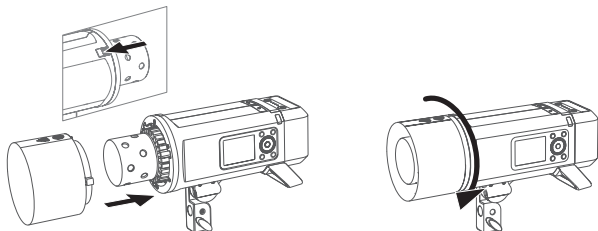

**Disassembling the Reflector:** Press down the accessory locking pusher, rotate the reflector anticlockwise to unlock.

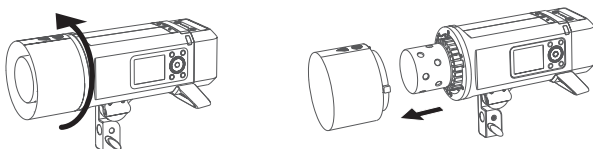

**Installing the Flash Tube:** Press down the accessory locking pusher, remove the reflector or other accessories. Match the flash tube in the tube socket and push until it is securely seated into the socket.

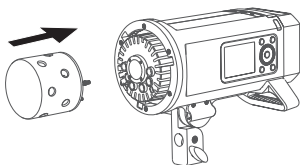

**Disassembling the Flash Tube:** Press down the accessory locking pusher, remove the reflector or other accessories. Grasp the flash tube and pull it out horizontally.

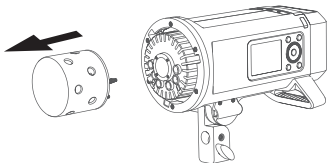

Note: Please power off and wear gloves for the above operations.

## Adjusting Flash Angle

1. Rotate the handle anticlockwise to unlock it, adjust the flash body for the desired angle, then rotate the handle clockwise to tighten.

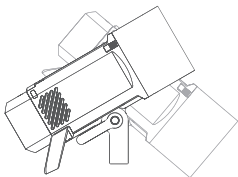

2. If the handle collides the flash body in rotation, please press the handle fixing fastener and pull out the handle, repeat the step 1 after stretching out a few distance.

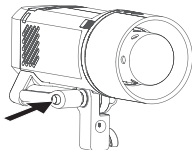

## Loading and Unloading the Battery

1. **Loading:** Match the battery's groove with the main battery compartment's ridge. Push down the battery pack until it is locked.

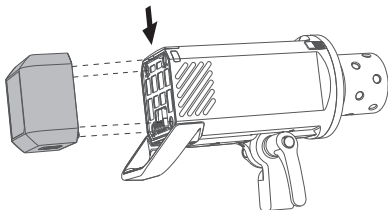

2. **Unloading:** Press the battery detaching pusher and push the battery pack upward at the same time to unload it.

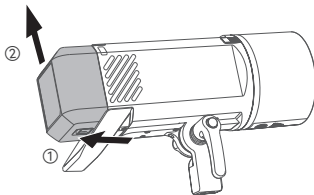

## Battery Level Indication

Attach the battery pack to the flash correctly. Check the battery level by pressing the battery indicator button and lightening the battery level indicator as the following table shows.

<b>Battery Level Indicator</b> (Indicating battery level and management of non-loaded battery)	<b>Meaning/Percentage of Battery Level</b>
1 red grid +3 green grids	75% ~ 100%
1 red grid +2 green grids	50% ~ 75%
1 red grid +1 green grid	25% ~ 50%
1 red grid	3% ~ 25%
2% flash red, 1% off	< 2% The battery level is going to be used out immediately. And the flash will alarm for 1 minute and auto power off in 3 minutes. Note: Please recharge the battery as soon as possible (within 10 days). Then, the battery can be used or be placed for long period.

Note: The indications are almost the same except for the grids shift.

# Battery Instructions

## Features

1. This flash unit uses li-ion battery which has long runtime. About 300 full power flashes in full battery level.
2. It is reliably safe. The inner circuit is against overcharge, overdischarge, overcurrent, and short circuit.
3. Take approx. 2h to fully charge the battery with the standard battery charger.

## Cautions

- Do not short circuit.
- Do not expose to rain or immerse into water. This battery is not waterproof.
- Keep out of reach of children.
- No over 8 hours' continuous charging.
- Store in dry, cool, ventilated places.
- Do not put aside or into fire.
- Dead batteries should be disposed according to local regulations.
- It is recommended to fully recharge the battery every three months.

## Battery Activation

Due to the battery upgrade, if you havent used the battery for more than a month, it will automatically go to sleep. please try to activate it if you use or charge again after a month.  
Activation method: Short press the battery indicator button to activate.

## Power Switch

1. Long press the power switch button until the unlock icon <  > is displayed on the panel, then rotate the select dial clockwise to turn on the device.
2. Long press the power switch button for until panel black out to turn off the device.

Note: Turn off the device if it will not be used for an extended period. This device is designed with an automatic power off function, which can be set in menu settings.

## TTL Auto Flash

In TTL mode, the camera's metering system detects the flash reflected from the subject and automatically adjusts the flash output so that the subject and background are evenly exposed.

Note: TTL mode is only available when the wireless function is on.

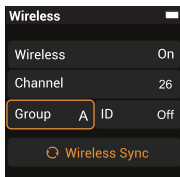

**Turn on wireless:** Press the MENU button to enter menu interface, turn the select dial and press the SET button to enter wireless and turn on it, set the channel, group and ID same as the transmitter unit. Press the MENU button twice to return to the main interface.

**Switch to TTL mode:** Press the MODE button to switch to TTL mode, the screen will display <TTL> icon.

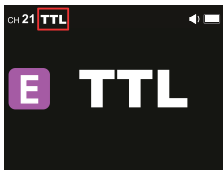

## M: Manual Flash

The flash output is adjustable from 1/1 full power to 1/512 power with 0.1 step increment. To obtain a correct flash exposure, use a hand-held flash meter to determine the required flash output.

**Switch to M mode:** Press the MODE button to switch to M mode, the screen will display < M > icon.

**Power Adjustment:** Turn the select dial to choose a desired flash output amount.



## Flash Output Range

The following table makes it easier to see how the step changes in terms of aperture value when you increase or decrease the flash output.

Turn the select dial clockwise to increase the flash output, while turn it anticlockwise to decrease the flash output.

1/512	1/512 (0.1 to 0.9)
1/256	1/256 (0.1 to 0.9)
1/128	1/128 (0.1 to 0.9)
1/64	1/64 (0.1 to 0.9)
1/32	1/32 (0.1 to 0.9)
1/16	1/16 (0.1 to 0.9)
1/8	1/8 (0.1 to 0.9)
1/4	1/4 (0.1 to 0.9)
1/2	1/2 (0.1 to 0.9)
1/1	(full power)

## Photocell (S1/S2)

Press the MENU button to enter menu interface, rotate the select dial and press the SET button to enter photocell settings, then rotate the select dial can choose among off, S1 and S2.

**S1 Secondary Unit:** The flash can function as an optical S1 secondary flash with optical sensor in M manual flash mode. With this function, the flash will fire synchronously when the main flash fires, the same effect as that by the use of wireless triggers. This helps create multiple lighting effects.

**S2 Secondary Unit (pre-flash):** The flash can also function as an optical S2 secondary flash with optical sensor in M manual flash mode. This is useful when cameras have pre-flash function. With this function, the flash will ignore a single "pre-flash" from the main flash and will only fire in response to the second, actual flash from the main unit.

Note: S1 and S2 optical triggering is only available in M manual flash mode.

## Display Flash Duration

Flash duration refers to the length of time that from flash's firing to reach the half peak at maximum. The half peak at maximum is usually expressed as  $t=0.5$ . In order to provide the photographer with more concrete data, this product adopts  $t=0.1$ . The difference between  $t=0.5$  and  $t=0.1$  is shown in the following picture.

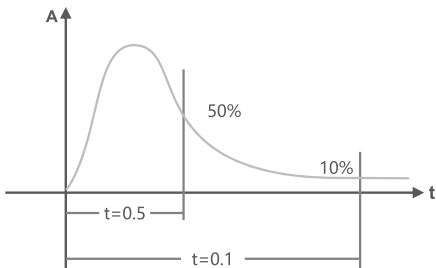

Note: Turn off the high speed sync function in M mode, the flash duration will then be displayed.



## Multi: Stroboscopic Flash

With stroboscopic flash, a rapid series of flashes is fired. It can be used to capture multiple images of a moving subject in a single photograph. You can set the flash output, number of flashes, and flash frequency (number of flashes per sec. expressed as Hz).

1. Press the MODE button so that < Multi > is displayed, turn the select dial to choose a desired flash output.
2. Press the SET button and turn the select dial to set the number of flashes.
3. Press the SET button and turn the select dial to set the flash frequency.

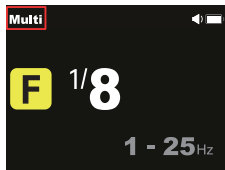

### Calculating the Shutter Speed

During stroboscopic flash, the shutter remains open until the firing stops. Use the formula below to calculate the shutter speed and set it with the camera.

Number of Flashes / Flash Frequency = Shutter Speed

For example, if the number of flashes is 10 and the firing frequency is 5 Hz, the shutter speed should be at least 2 seconds.

#### Note:

- Stroboscopic flash is most effective with a highly reflective subject against a dark background.
- Using a tripod and a TTL flash trigger is recommended.
- A flash output of 1/1 and 1/2 cannot be set for stroboscopic flash.
- Stroboscopic flash can be used with "bulb".

## Maximum Stroboscopic Flashes:

Flash Output \ Hz	1	2	3	4	5	6-7	8-9	10	11	12-14	15-19	20-50	60-100
1/4	5	4	3	2	2	2	2	2	2	2	2	2	2
1/8	20	15	12	10	8	6	5	4	4	4	4	4	4
1/16	30	30	30	20	20	20	10	8	8	8	8	8	8
1/32	60	60	60	50	50	40	30	20	20	20	18	16	12
1/64	90	90	90	80	80	70	60	50	40	40	35	30	20
1/128	100	100	100	100	100	90	80	70	70	60	50	40	40
1/256	100	100	100	100	100	90	80	70	70	60	50	40	40
1/512	100	100	100	100	100	90	80	70	70	60	50	40	40



## High-Speed Sync

High speed sync (FP flash) enables the flash to synchronize with all camera shutter speeds. This is convenient when you want to use aperture priority for fill-flash portraits.

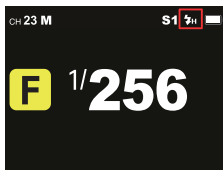
Press the MENU button to enter menu interface, turn the select dial and press the SET button to enter high speed sync and turn on it. Then press MENU button to return to the main interface, the HSS icon  can be seen on the panel.



Note:

- If you set a shutter speed that is the same as or slower than the camera's maximum flash sync speed,  will not be displayed in the viewfinder.
- With high-speed sync, the faster the shutter speed, the shorter the effective flash range.
- To return to normal flash, turn off the high-speed sync function in menu settings. Then  will disappear.
- Multi flash mode cannot be set in high-speed sync mode.
- Over-temperature protection may be activated after 64 consecutive high-speed sync flashes.

## Wireless (2.4G) Transmission

AD800Pro adopts 2.4G wireless X system, which has good compatibility with other Godox products. It can automatically switch to receiver unit according to the transmitter unit instead of setting manually. The compatible cameras include Canon, Nikon, Sony, OM SYSTEM, Panasonic, Fujifilm, Pentax, Leica, etc.

As a receiver unit, AD800Pro can be controlled by the following transmitter units: XPROII series/X3 series /X2T series /V1Pro series /V1 series /V860III series.

## Wireless Settings

Press the MENU button to enter menu interface, turn the select dial and press the SET button to choose among wireless/channel/group/ID/wireless sync, then turn the select dial and press the SET button to adjust the parameters. Press the MENU button to return to the previous menu, press again to return to the main interface.

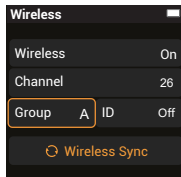

## Setting the Communication Parameters

If there are other wireless flash systems nearby, you can change the channel to prevent signal interference. The channels of the transmitter unit and the receiver unit(s) must be set to the same.

Wireless	On/Off
Channel	1-32
Group	0-9, A-F
ID	Off, 1-99
Wireless Sync	Approx. 100m wireless transmission

Note:

When using a transmitter without wireless sync function to control AD800Pro, the channel, group and ID need to be set manually.

When using a transmitter with wireless sync function to control AD800Pro, the channel, group and ID can be set quickly by wireless sync.

### Wireless Sync (Take X3 flash trigger as an example):

1. Turn off the camera and mount the flash trigger on camera hot shoe. Then, power on the flash trigger and the camera.
2. Slide the screen of X3 down from the top to display <Setting>, press <Setting> to enter C.Fn. menu, then press <Wireless> and select <Wireless Sync>.
3. Press the MENU button of AD800Pro to select wireless and turn it on, then turn the select dial to select <Wireless Sync>.
4. Their CHs and IDs will automatically be set to the same.
5. Set the flash mode and output power level of groups on the flash trigger.
6. Press the trigger button on flash trigger or camera shutter to trigger.

## Wireless Flash Shooting

Positioning and Operation Range (Example of wireless flash shooting)

- Auto flash shooting with one receiver unit

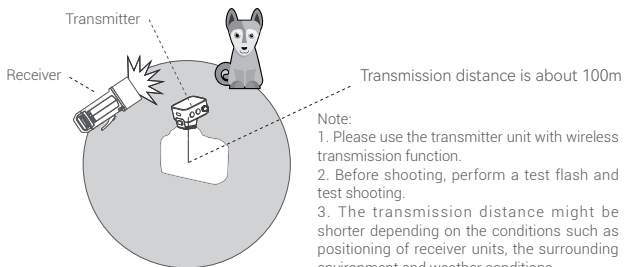

Note:

1. Please use the transmitter unit with wireless transmission function.
2. Before shooting, perform a test flash and test shooting.
3. The transmission distance might be shorter depending on the conditions such as positioning of receiver units, the surrounding environment and weather conditions.
4. The receiver unit can be turned off on the transmitter unit.

## Wireless Multiple Flash Shooting

You can divide the receiver units into two or three groups and perform TTL auto flash while changing the flash ratio (factor). In addition, you can set and shoot with a different flash mode for each firing group.

- Auto flash shooting with two receiver units

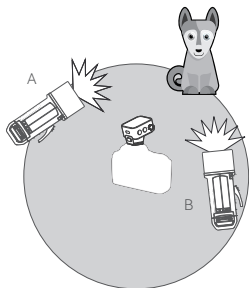

- Auto flash shooting with three receiver units

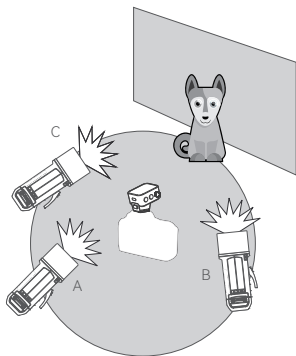

## Godox FT433 Function

To create enhanced signal stability and anti-interference capabilities, and to achieve precise control of the flash, it is recommended to use Godox FT433 flash trigger. With built-in 433 MHz wireless module, the transmitter FT433 can be collocated with the receiver FR433 to achieve longer transmission distance while greatly decreasing the interference. FT433 is compatible with Canon, Nikon and Sony cameras, can control Godox flashes such as AD800Pro, AD100Proll, AD200Proll, AD400Proll, AD600Proll and AD600BMII.

### Operation Instructions

1. Turn off the flash trigger, camera and flash, mount the transmitter FT433 on camera hot shoe, insert the receiver FR433 into the USB-C port of AD800Pro. Rotate the antenna out from the top of the transmitter and receiver. Then, power on the flash trigger, camera and flash.
2. Set FT433: Press the [MENU button] and select <  > to set channel and ID. Then press the [MENU button] to return the main interface. Press [MODE-LOCK button] to set flash trigger mode, rotate the select dial to set flash trigger level.
3. Set AD800Pro: Press the [MENU button] to enter menu interface, rotate the [select dial] to select wireless, press the <SET button> to enter wireless setting interface, turn on wireless, set the same channel, group and ID to the flash trigger.
4. Press the camera shutter to trigger and the status lamp of the flash trigger turns red synchronously.

Note: Flash trigger FT433 is sold separately

## Flash Mode

Press the MENU button to enter menu interface, turn the select dial and press the SET button to enter flash mode, in which you can choose among normal, color and freeze.

<b>Normal</b>	Normal flash mode, with no indication on the main interface.
<b>Color</b>	Stable color temperature mode, with < © > on the main interface. The group indicator will blink and the beeper will beep for 1min if it has been turned on, please press the test button to resume to normal use. The stable color temperature function is only available in non-HSS M mode, and value of which will shift around $\pm 75K$ over the entire power range.
<b>Freeze</b>	Freeze mode, with < F > on the main interface. The flash duration is shorter than the normal flash mode, and the power is also less than the normal flash mode. The freeze mode is only available in M mode and Multi mode.



## Modeling Lamp

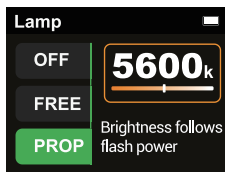
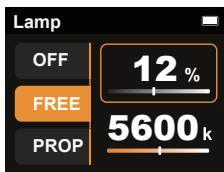

AD800Pro is equipped with 40W bi-color LED modeling lamp. Press the modeling lamp button to enter modeling lamp settings, turn the select dial to choose among off/free/prop, then turn the select dial and press the SET button to adjust the parameters. Press the modeling lamp button to return to the main interface.



Level 1 Options	Level 2 Options	Notes
OFF	/	Turn off the modeling lamp
FREE	10%-100% (with 1% increment)	Brightness range
	2800K-6000K (with 100K increment)	CCT range
PROP	2800K-6000K (with 100K increment)	CCT range, and brightness follows flash power.

## MENU Settings

Icons	Functions	Options	Notes
	Wireless	Off	Turn off wireless function
		On	Turn on wireless function
	Flash Mode	Normal	Normal flash mode
		Color	Available in non-HSS M mode
		Freeze	Available in M mode and Multi mode
	Photocell	Off	Turn off photocell
		S1	Turn on photocell in M mode and TTL mode
		S2	
	HSS	Off	Turn off high speed sync
		On	Turn on high speed sync in M mode and TTL mode
	Model	Inter	Modeling lamp off in triggering
		Cont	Modeling lamp constant on
	Beep	Off	Beep is off
		On	Beep is on
	Type	1/512	Flash step displays as 1/512 -1/1
		1.0	Flash step displays as 1.0 -10.0 in non-HSS mode
	Standby	30sec	Screen blacks out in 30sec of idle use
		1min	Screen blacks out in 1min of idle use
		2min	Screen blacks out in 2min of idle use
		3min	Screen blacks out in 3min of idle use
	Auto Off	Off	Turn off auto off function
		30min	Auto off in 30min
		60min	Auto off in 60min
		90min	Auto off in 90min
		120min	Auto off in 120min
	Brightness	20%-100%	Turn the select dial to adjust
	Delay	Off	Turn off delay flash
		0.01s-30.0s	Turn the select dial to adjust delay flash
	Mask	Mask (Off, 2-8)	Masks and alt must be used in combination, the mask represents the total number of flashes, and the alt represents the nth flash, multi-selection is also available. For example: choose 7 for mask, choose 1 and 5 for alt, then the flash only flash the 1st and 5th out of 7 flashes
		Alt (1-8)	

	Language	Chinese	Simplified Chinese operating system
		English	English operating system
	Reset	Yes	Factory reset
		No	Cancel factory reset
	Device Info		Display the current model and version

## Sync Triggering

The sync cord jack is a  $\Phi 3.5\text{mm}$  plug. Insert a trigger plug in and the flash will be fired synchronously with the camera shutter.

## Protection Function

### 1. Over-Temperature Protection

- To avoid overheating and deteriorating the flash head, do not fire more than 64 continuous flashes in fast succession at 1/1 full power. After 64 continuous flashes, allow a rest time of at least 10 minutes.
- If you fire more than 64 continuous flashes and then fire more flashes in short intervals, the inner over-temperature protection function may be activated and make the recycling time over 10 seconds. If this occurs, allow a rest time of about 10 minutes, and the flash unit will then return to normal.
- When the over-temperature protection is started, <  > is shown on the screen.

**Number of flashes that will activate over-temperature protection:**

Power Output Level	Number of Flashes
1/1	80
1/2 (+0.7)	105
1/2 (+0.3)	128
1/2	160
1/4 (+0.3, +0.7)	210
1/8 (+0.3, +0.7)	375
1/16 (+0.3, +0.7)	800
1/32 (+0.3, +0.7)	1060
1/64 (+0.3, +0.7)	

Power Output Level	Number of Flashes
1/128 (+0.3, +0.7)	2130
1/256 (+0.3, +0.7)	
1/512 (+0.3, +0.7)	

**Number of flashes that will activate over-temperature protection in high-speed sync triggering mode:**

Power Output Level	Number of Flashes
1/1	64
1/2 (+0.3, +0.7)	70
1/4 (+0.3, +0.7)	90
1/8 (+0.3, +0.7)	115
1/16 (+0.3, +0.7)	140
1/32 (+0.3, +0.7)	180
1/64 (+0.3, +0.7)	210
1/128 (+0.3, +0.7)	235
1/256 (+0.3, +0.7)	255

## 2. Other Protections

The system provides real-time protection to secure the device and your safety. The following lists prompts for your reference:

Display	Meaning
Error1	A failure occurs on the recycling system so that the flash cannot fire. Please restart the flash unit. If the problem still exists, please send this product to a maintenance center.
Error3	The voltage on two outlets of the flash tube is too high. Please send this product to a maintenance center.
Error9	There are some errors occurred during the upgrading process. Please using the correct firmware upgrade method.

## The Reason & Solution of Not Triggering in Godox 2.4G Wireless

### **1. Disturbed by the 2.4G signal in outer environment (e.g. wireless base station, 2.4G wifi router, Bluetooth, etc.)**

→ To adjust the channel CH setting on the flash trigger (add 10+ channels) and use the channel which is not disturbed. Or turn off the other 2.4G equipment in working.

### **2. Please make sure that whether the flash has finished its recycle or caught up with the continuous shooting speed or not (the flash ready indicator is lightened) and the flash is not under the state of over-heat protection or other abnormal situation.**

→ Please downgrade the flash power output. If the flash is in TTL mode, please try to change it to M mode.

### **3. Whether the distance between the flash trigger and the flash is too close or not ( < 0.5m).**

→ Please turn on "short distance wireless mode" of the flash trigger.

→ X1 Series: Press and hold the triggering button then turn on the device, until the indicator blinks twice.

→ XPro and X2T Series: Please set the C.Fn-DIST to 0-30m.

→ X3 Series: Please set the triggering distance to 0-30m.

### **4. Whether the flash is in the low battery states or not.**

→ Please charge or replace the battery in time, and ensure both devices have enough battery power.

### **5. The flash trigger's firmware is an older version**

→ Please upgrade the firmware of the flash trigger referring to the instruction manual for specific firmware upgrades.

### **6. The camera's firmware is an older version**

→ Please upgrade the firmware of the camera referring to its instruction manual.

## Technical Data

Model	AD800Pro
Wireless Receiver Unit Mode	Wireless Mode (compatible with Canon E-TTL II, Nikon i-TTL, Sony, OM SYSTEM, Panasonic, Fujifilm, Leica, Pentax)
Flash Mode	Wireless off: M/Multi Wireless receiver mode:TTL/M/Multi
Guide No. (1/1 step)	110 (ISO 100,in meters,with efficient reflector)
Flash Duration (t=0.1)	Normal:1/350s~1/11400s Color:1/350s~1/9220s Freeze:1/5020s~1/35710s
Power (1/1 step)	800Ws
Power Output	10 steps:1/512 ~ 1/1 (with 0.1 increment each step) Note: 9 steps in CCT mode.
Stroboscopic Flash	Provided (up to 100 times, 100Hz)
Sync Mode	High-speed sync (up to 1/8000 seconds), first-curtain sync, and second-curtain sync
Delay Flash	0.01 ~ 30s
Mask	√
Fan	√
Beep	√
Flash Duration Indication	√
Photocell	S1/S2/OFF
Display	Color screen
Modeling Lamp	
Max. Input Power	40W
Brightness Range	10%-100%
CRI	Average≥97
TLCI	Average≥98
CCT	2800K-6000K
Wireless Flash (2.4G transmission)	
Wireless Function	Receiver, Off
Controllable Receiver Groups	16: 0-9, A-F
Transmission Range	Approx. 100m
Channels	32:1-32
ID	01-99/OFF

<b>Power Supply</b>	
Power Supply	Lithium battery(28.8V/2900mAh)
Full Power Flashes	Approx.300
Recycle Time	Quickest approx. 0.01s ~ 1.5s
Battery Level Indicator	√
Power Saving	Auto off function is available in menu settings (30min to 120min of idle use)
Sync Triggering Mode	3.5mm sync cord
Flash Tube Color Temperature	5800±200K
<b>Dimensions and Weights</b>	
Dimension (with battery, flash tube and reflector)	≈4.96*6.1*13.5"
Net Weight (with battery, flash tube and reflector)	≈3.7kg

Specifications and data may subject to changes without notice.

## Firmware Upgrade

- This flash supports firmware upgrade through the USB-C port. Update information will be released on our official website.
- Please use an USB-C cable (sold separately) for firmware upgrade.
- As the firmware upgrade needs the support of Godox G3 software, please download and install the software from Godox official website (<https://www.godox.com.cn/firmware-G3/>) before upgrading. Then, choose the related firmware file.
- Please refer to the latest electronic version of the instruction manual.

## Warning

Operating frequency:2412.99MHz-2464.49MHz (only receive)

## Declaration of Conformity

GODOX Photo Equipment Co.,Ltd. hereby declares that this equipment are in compliance with the essential requirements and other relevant provisions of Directive 2014/53/EU. In accordance with Article 10(2) and Article 10(10), this product is allowed to be used in all EU member states.For more information of DoC, Please click this web link:

<https://www.godox.com/eu-declaration-of-conformity/>

The device complies with RF specifications when the device used at 0mm from your body.

## FCC Caution

This device complies with part 15 of the FCC Rules. Operation is subject to the following two conditions:

- (1) This device may not cause harmful interference, and
- (2) this device must accept any interference received, including interference that may cause undesired operation.

Any Changes or modifications not expressly approved by the party responsible for compliance could void the user's authority to operate the equipment.

## IC Warning

This device complies with Industry Canada licence-exempt RSS standard(s). Operation is subject to the following two conditions:

- (1) This device may not cause interference, and
- (2) This device must accept any interference, including interference that may cause undesired operation of the device.

Le présent appareil est conforme aux CNR d'Industrie Canada applicables aux appareils radio exempts de licence. L'exploitation est autorisée aux deux conditions suivantes:

- (1) l'appareil ne doit pas produire de brouillage, et
- (2) l'utilisateur de l'appareil doit accepter tout brouillage radioélectrique subi, même si le brouillage est susceptible d'en compromettre le fonctionnement

## 产品保修

尊敬的用户，本保修卡是申请保修服务的重要凭证，请您配合销售商填写并妥善保管，谢谢！

产品信息	型号	产品条码
用户信息	姓名	联系电话
	通信地址	
销售商信息	名称	
	联系电话	
	通信地址	
	销售日期	
备注		

注：此表应由销售商盖章确认。

### 产品信息

本文件适用于相关《产品保修信息》(见后面说明)所列产品,其他非属此范围的产品或部件(如促销品、赠品及其他出厂后附加的部件等)不在此保修承诺内。

### 保修期

产品及部件的相应保修期按相关的《产品保修信息》执行。保修期自产品首次购买日起算,购买日以购买产品时保修卡登记日期为准。

### 如何获得保修服务

您可直接与产品销售商或授权服务机构联系,也可拨打神牛产品售后服务电话,与我们联系,由我们的服务人员为您安排服务。申请保修时,您应提供有效的保修卡作为保修凭证,方可获得保修。如您不能提供有效的保修卡,则在我们确认产品或部件属于保修范围的情况下,也可以为您提供保修,但这不作为我们的义务。

## 不适用保修情况

如产品存在下列情况，本文件项下的保证和服务将不适用：①产品或部件超过相应保修期；②错误或不当使用、维护或保管导致的故障或损坏，如：不当搬运；非按产品合理预期用途使用；不当插拔外接设备；跌落或外力挤压；接触或暴露于不当温度、溶剂、酸碱、水浸或潮湿环境；③由非神牛授权机构或人员安装、修理、更改、添加或拆卸造成的故障或损坏；④产品或部件原有识别信息被修改变更或删除；⑤无有效保修卡；⑥使用非合法授权、非标准或非公开发行的软件造成的故障或损坏；⑦因不可抗力或意外事件造成的故障或损坏；⑧其他非因产品本身质量问题导致的故障或损坏。遇上述情况，您应向相关责任方寻求解决，神牛对此不承担任何责任。因非在保修期或保修范围内的部件、附件或软件导致产品不能正常使用的，不是保修范围内的故障。产品使用过程中正常的脱色，磨损和消耗，不是保修范围内的故障。

## 产品保修和服务支持信息

产品的保修期和服务类型按以下《产品保修信息》执行：

产品类别	选件名称	保修期（月）	保修服务类型
部件	电路板	12	客户送修
	电池	3	客户送修
	充电器等带电性能的部件。	12	客户送修
其他	如闪光管、造型灯泡、外壳、保护罩、锁紧装置、包装等。	无	无保修

神牛产品售后服务电话 0755-29609320-8062

## Warranty

Dear customers, as this warranty card is an important certificate to apply for our maintenance service, please fill in the following form in coordination with the seller and safe-keep it. Thank you!

Product Information	Model	Product Code Number
Customer Information	Name	Contact Number
	Address	
Seller Information	Name	
	Contact Number	
	Address	
	Date of Sale	
Note		

Note: This form shall be sealed by the seller.

### Applicable Products

Applicable Products The document applies to the products listed on the Product Maintenance Information (see below for further information). Other products or accessories (e.g. promotional items, giveaways and additional accessories attached, etc.) are not included in this warranty scope.

### Warranty Period

The warranty period of products and accessories is implemented according to the relevant Product Maintenance Information. The warranty period is calculated from the day (purchase date) when the product is bought for the first time, and the purchase date is considered as the date registered on the warranty card when buying the product.

### How to Get the Maintenance Service

If maintenance service is needed, you can directly contact the product distributor or authorized service institutions. You can also contact the Godox after-sale service call and we will offer you service. When applying for maintenance service, you should provide valid warranty card. If you cannot provide valid warranty card, we may offer you maintenance service once confirmed that the product or accessory is involved in the maintenance scope, but that shall not be considered as our obligation.

## Inapplicable Cases

The guarantee and service offered by this document are not applicable in the following cases:

① The product or accessory has expired its warranty period; ② Breakage or damage caused by inappropriate usage, maintenance or preservation, such as improper packing, improper usage, improper plugging in/out external equipment, falling off or squeezing by external force, contacting or exposing to the improper temperature, solvent, acid, base, flooding and damp environments, etc; ③ Breakage or damage caused by non-authorized institution or staff in the process of installation, maintenance, alternation, addition and detachment; ④ The original identifying information of product or accessory is modified, alternated, or removed; ⑤ No valid warranty card; ⑥ Breakage or damage caused by using illegally authorized, nonstandard or non-public released software; ⑦ Breakage or damage caused by force majeure or accident; ⑧ Breakage or damage that could not be attributed to the product itself. Once met these situations above, you should seek solutions from the related responsible parties and Godox assumes no responsibility. The damage caused by parts, accessories and software that beyond the warranty period or scope is not included in our maintenance scope. The normal discoloration, abrasion and consumption are not the breakage within the maintenance scope.

## Maintenance and Service Support Information

The warranty period and service types of products are implemented according to the following Product Maintenance Information:

Product Type	Name	Maintenance Period(month)	Warranty Service Type
Parts	Circuit board	12	Customer sends the product to designated site
	Battery	3	Customer sends the product to designated site
	Electrical parts e.g.battery charger, etc.	12	Customer sends the product to designated site
Other Items	Power cord, Sync cord, flash tube, modeling lamp, shell, lamp cover, locking device, package, etc.	No	Without warranty