

User's Manual

FlexScan[®] S1703 S1903 S1933

Color LCD Monitor

Important

Please read PRECAUTIONS, this User's Manual, and the Setup Guide (separate volume) carefully to familiarize yourself with safe and effective usage.

-
- Please refer to the Setup Guide for basic information ranging from connection of the monitor to a PC to using the monitor.
 - The latest User's Manual is available for download from our web site:
<http://www.eizo.com>
-



[Location of the Caution Statements]

S1703 (Ex.Tilt Stand)

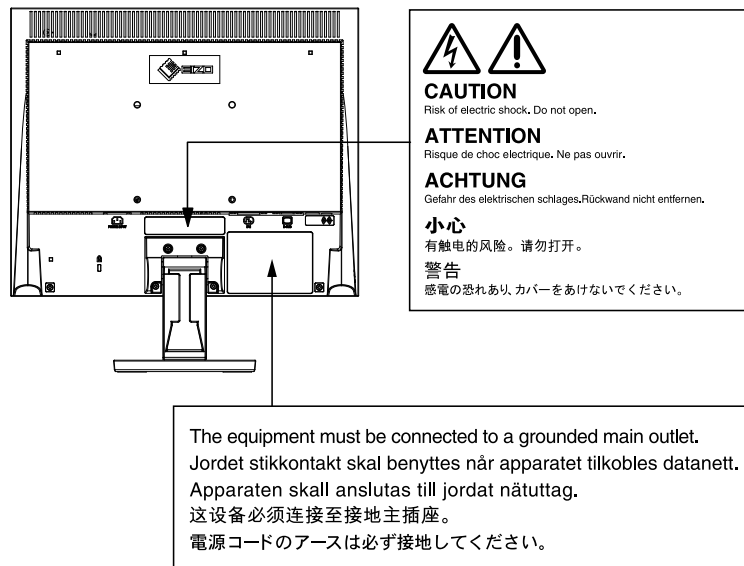

S1903 / S1933 (Ex.Tilt Stand)

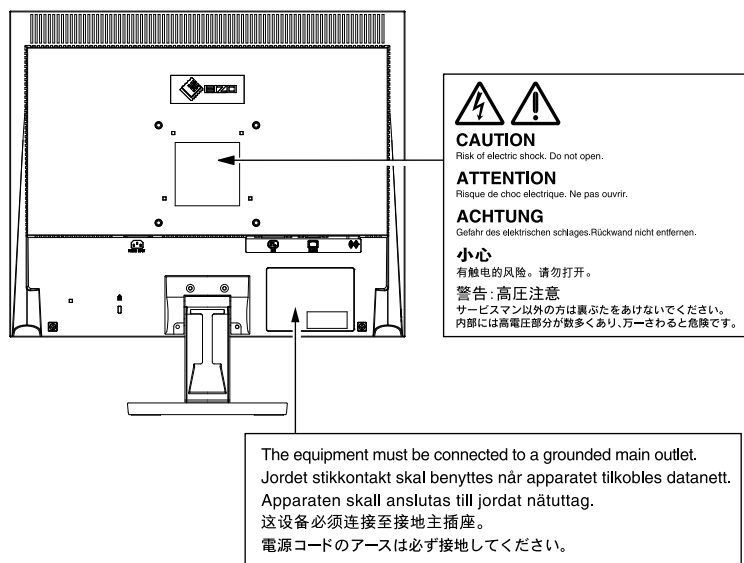

As an ENERGY STAR Partner, EIZO Corporation has determined that this product meets the ENERGY STAR guidelines for energy efficiency.



This product has acquired the TCO standard that relates to the safety, ergonomics, environment and so forth of office equipment. For an overview of the TCO, refer to our web site.

<http://www.eizo.com>

This product has been adjusted specifically for use in the region to which it was originally shipped. If operated outside this region, the product may not perform as stated in the specifications.

No part of this manual may be reproduced, stored in a retrieval system, or transmitted, in any form or by any means, electronic, mechanical, or otherwise, without the prior written permission of EIZO Corporation.

EIZO Corporation is under no obligation to hold any submitted material or information confidential unless prior arrangements are made pursuant to EIZO Corporation's receipt of said information. Although every effort has been made to ensure that this manual provides up-to-date information, please note that EIZO monitor specifications are subject to change without notice.

Kensington and MicroSaver are trademarks of ACCO Brands Corporation.

VESA is a registered trademark of Video Electronics Standards Association.

Windows, Windows Media, Windows Vista, SQL Server, and Xbox 360 are registered trademarks of Microsoft Corporation in the United States and other countries.

Apple, ColorSync, eMac, iBook, iMac, iPad, Mac, MacBook, Macintosh, Mac OS, PowerBook, and QuickTime are registered trademarks of Apple Inc.

ENERGY STAR is a registered trademark of the United States Environmental Protection Agency in the United States and other countries.

EIZO, the EIZO Logo, ColorEdge, DuraVision, FlexScan, FORIS, RadiCS, RadiForce, RadiNET, Raptor, and ScreenManager are registered trademarks of EIZO Corporation in Japan and other countries.

ColorNavigator, EcoView NET, EIZO EasyPIX, EIZO ScreenSlicer, i•Sound, Screen Administrator, and UniColor Pro are trademarks of EIZO Corporation.

All other company and product names are trademarks or registered trademarks of their respective owners.

Notice for this monitor

This product is suited to general purposes like creating documents, viewing multimedia content.

This product has been adjusted specifically for use in the region to which it was originally shipped. If the product is used outside the region, it may not operate as specified in the specifications.

This product may not be covered by warranty for uses other than those described in this manual.

The specifications noted in this manual are only applicable when the following are used:

- Power cords provided with the product
 - Signal cables specified by us
-

Only use optional products manufactured or specified by us with this product.

As it takes about 30 minutes for the performance of electrical parts to stabilize, adjust the monitor 30 minutes or more after the monitor power has been turned on.

Monitors should be set to a lower brightness to reduce changes in luminosity caused by long-term use and maintain a stable display.

When the screen image is changed after displaying the same image for extended periods of time, an afterimage may appear. Use the screen saver or power save function to avoid displaying the same image for extended periods of time.

Periodic cleaning is recommended to keep the monitor looking new and to prolong its operation lifetime (refer to [“Cleaning” \(page 5\)](#)).

The LCD panel is manufactured using high-precision technology. Although, missing pixels or lit pixels may appear on the LCD panel, this is not a malfunction. Percentage of effective dots: 99.9994% or higher.

The backlight of the LCD panel has a fixed lifetime. When the screen becomes dark or begins to flicker, please contact your local EIZO representative.

Do not press on the panel or edge of the frame strongly, as this may result in display malfunctions, such as interference patterns, etc. If pressure is continually applied to the panel, it may deteriorate or damage your panel. (If the pressure marks remain on the panel, leave the monitor with a black or white screen. The symptom may disappear.)

Do not scratch or press on the panel with any sharp objects, as this may result in damage to the panel. Do not attempt to brush with tissues as this may scratch the panel.

When the monitor is cold and brought into a room or the room temperature goes up quickly, dew condensation may occur on the interior and exterior surfaces of the monitor. In that case, do not turn the monitor on. Instead wait until the dew condensation disappears, otherwise it may cause some damage to the monitor.

Cleaning

Attention

- Chemicals such as alcohol and antiseptic solution may cause gloss variation, tarnishing, and fading of the cabinet or panel, and also quality deterioration of the image.
 - Never use any thinner, benzene, wax, and abrasive cleaner, which may damage the cabinet or panel.
-

NOTE

- The optional ScreenCleaner is recommended for cleaning the cabinet and panel surface.
-

The stains on the cabinet and panel surface can be removed by moistening part of a soft cloth with water.

To use the monitor comfortably

- An excessively dark or bright screen may affect your eyes. Adjust the brightness of the monitor according to the environmental conditions.
- Staring at the monitor for a long time tires your eyes. Take a 10-minute rest every hour.

CONTENTS

Notice for this monitor	4	2-13 Locking Buttons	21
CONTENTS	6	• To lock adjustments/settings in the Adjustment menu	21
Chapter 1 Features and Overview	7	2-14 Enabling/Disabling DDC/CI communication	22
1-1 Features	7	2-15 Setting EIZO logo display ON/OFF	22
1-2 Buttons and Indicators	8	2-16 Resuming the Default Setting [Reset]	22
1-3 Functions and Basic Operation	10	• To reset color adjustment values	22
Chapter 2 Settings and Adjustments	12	• To reset all adjustments to the factory default settings	22
2-1 Set a Sync-on-Green Signal	12	Chapter 3 Connecting Cables	23
2-2 Setting Screen Resolution	12	3-1 Connecting Multiple PCs to the Monitor	23
Compatible Resolutions/Frequencies	12	• To switch the input signal	23
Setting Resolution	13	• To set input signal selection [Input Signal]	23
2-3 Utility Disk	14	Chapter 4 Troubleshooting	24
• Disk contents and software overview	14	Chapter 5 Reference	26
• To use ScreenManager Pro for LCD (DDC/CI)/EIZO ScreenSlicer	14	5-1 How to Attach the Optional Arm	26
2-4 Screen Adjustment	15	5-2 Power Saving Mode	27
Digital Input	15	5-3 Specifications	28
Analog Input	15	5-4 Glossary	36
2-5 Color Adjustment	18	5-5 Preset Timing	38
• To select the display mode (FineContrast mode)	18	FCC Declaration of Conformity	39
• To perform advanced adjustments	18	Hinweise zur Auswahl des richtigen Schwenkarms für Ihren Monitor	40
• Adjustment items in each mode	18	LIMITED WARRANTY	41
• To set/adjust color	19	Recycling Information	50
2-6 Turning off the monitor automatically [Eco Timer]	20	China Measures for RoHS Compliance in ChinaRoHS	54
2-7 Setting Adjustment Menu Position [Menu Position]	20		
2-8 Setting Power Indicator ON/OFF [Power Indicator]	20		
2-9 Displaying Monitor Information [Information]	20		
2-10 Setting Language [Language]	21		
2-11 Setting On/Off for the automatic brightness adjustment function [Auto EcoView]	21		
2-12 Displaying the level of power saving by EcoView Index	21		

Chapter 1 Features and Overview

Thank you very much for choosing an EIZO color LCD monitor.

1-1 Features

- Applicable to the resolution of 1280 × 1024
- Stereo speakers
- Power saving function

Suppressing the power consumption* reduces the carbon dioxide emissions. This product is equipped with various power saving functions.

– Auto EcoView function

The sensor on the front side of the monitor detects the environmental brightness to adjust the screen brightness automatically and comfortably.

Excessively high brightness may lead a damage to the natural environment as well as to your eyes. Suppressing the excessively high brightness will be helpful to reduce the power consumption and the damage to your eyes.

[“2-11 Setting On/Off for the automatic brightness adjustment function \[Auto EcoView\]” \(page 21\)](#)

– EcoView Index function

This indicator shows the power saving ratio, power reduction and CO₂ reduction as a result of the brightness

of the monitor. You can realize the power consumption reduction by taking consideration in the ratio of power saving.

[“2-12 Displaying the level of power saving by EcoView Index” \(page 21\)](#)

- FineContrast function to allow the best mode for screen display
 - Features Paper mode showing a view when printed onto paper
 - [To select the display mode \(FineContrast mode\)” \(page 18\)](#)
- Supports portrait and landscape formats (For height adjustable stand)
- The software “ScreenManager Pro for LCD (DDC/CI)” to adjust the screen using the mouse and keyboard is included
 - [“2-3 Utility Disk” \(page 14\)](#)

* Reference values:

-S1703

Maximum power consumption:
25W (Luminance Max., at default settings)

Standard power consumption: 9W
(Luminance 120cd/m², at default settings)

-S1903

Maximum power consumption:
23W (Luminance Max., at default settings)

Standard power consumption: 11W
(Luminance 120cd/m², at default settings)

-S1933

Maximum power consumption:
24W (Luminance Max., at default settings)

Standard power consumption: 12W
(Luminance 120cd/m², at default settings)

Note

- When using the monitor screen in a portrait position, the graphics board supporting portrait display is required. When placing the monitor in a portrait position, the settings of your graphics board need to be changed. Refer to the User’s Manual of the graphics board for details.

1-2 Buttons and Indicators Front

Adjustment menu (ScreenManager*1)

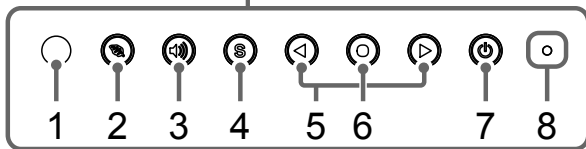
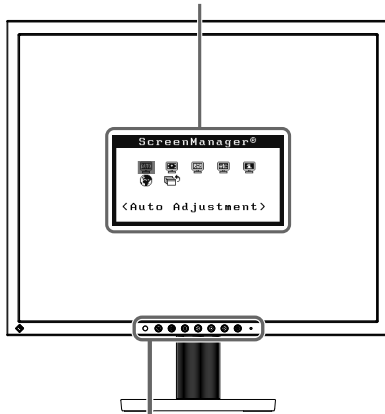

Tilt Stand

Adjustment menu (ScreenManager*1)

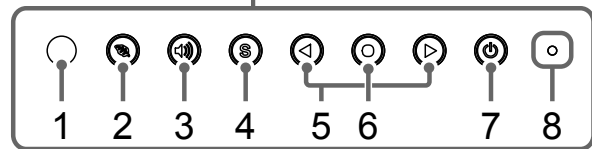
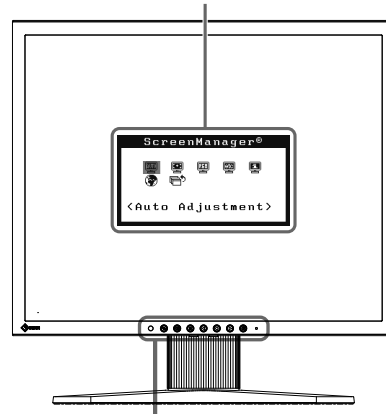

Height adjustable Stand

1	Sensor	The sensor detects ambient brightness. Auto EcoView function (page 21)
2	EcoView button	Displays the setting menu of Auto EcoView and EcoView Index (page 21).
3	Volume control button	Displays the volume adjustment menu (page 10).
4	Input Signal Selection button	Switches input signals for display.
5	Control buttons (Left, Right)	<ul style="list-style-type: none"> Displays the brightness adjustment window (page 10). Chooses an adjustment item or increases/decreases adjusted values for advanced adjustments using the Adjustment menu (page 11).
6	Enter button	Displays the Adjustment menu, determines an item on the menu screen, and saves values adjusted.
7	Power button	Turns the power on or off.
8	Power indicator	Indicates monitor's operation status. Blue: Operating Orange: Power saving Off: Power off

*1 ScreenManager is an EIZO's nickname of the Adjustment menu. See "[Basic operation of Adjustment menu](#)" ([page 11](#)) for how to use.

Rear

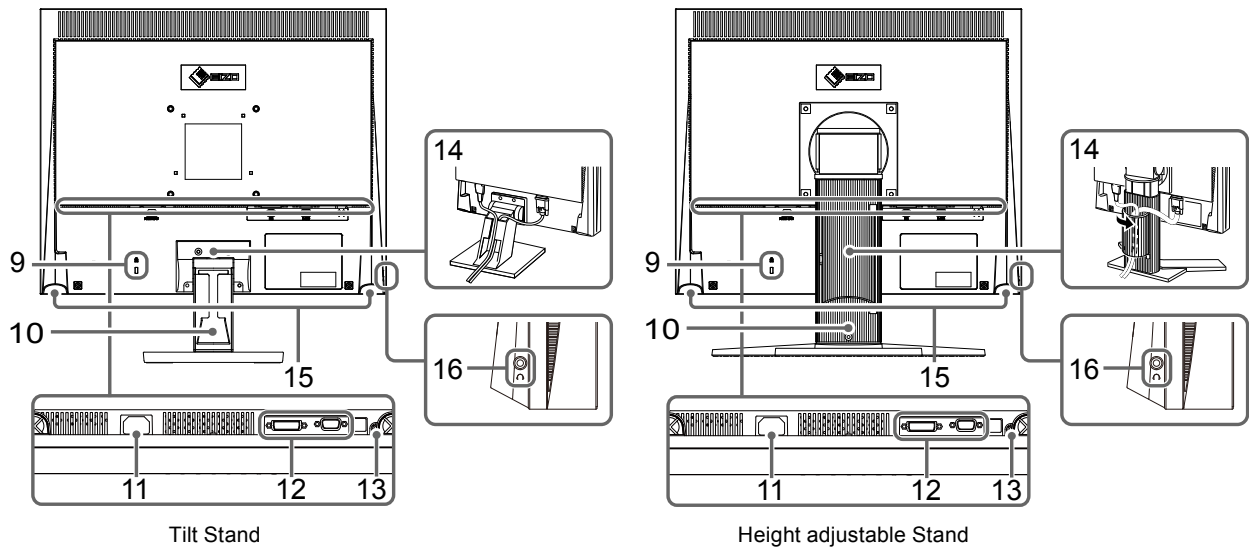

9	Security lock slot	Complies with Kensington's MicroSaver security system.
10	Stand*2	Tilt Stand : Used to adjust the angle (tilt) of the monitor screen. Height adjustable Stand : Adjusts the height and angle (tilt and swivel) of the monitor.
11	Power connector	Connects the power cord.
12	Input signal connectors	Left: DVI-D connector/Right: D-Sub mini 15-pin connector
13	Stereo mini jack	Connects the stereo mini jack cable.
14	Cable holder	Covers the monitor cables.
15	Speaker	Outputs audio source.
16	Headphone jack	Connects the headphones.

*2 An optional arm (or an optional stand) can be attached by removing the stand section. (Refer to "5-1 How to Attach the Optional Arm" (page 26))

1-3 Functions and Basic Operation

To adjust the screen and color

● Main menu (Refer to [page 11](#) for operation)

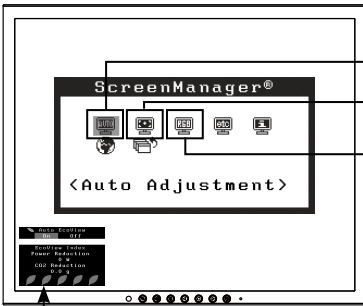

- The Adjustment menu and the EcoView menu cannot be displayed at the same time.

EcoView menu

- Setting On/Off for the automatic brightness adjustment function
[Auto EcoView]..... see [page 21](#)
1 Press .
2 Change “On” and “Off” with or .
- Displaying the level of power saving by EcoView Index see [page 21](#)
Press to display the level of power saving mode.

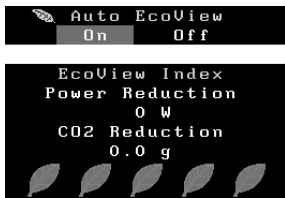

Brightness Adjustment

Press or to adjust brightness.

Volume Adjustment

1 Press .



2 Press or to adjust volume.

(for analog signal input only)

1 Screen Adjustment (Automatic Adjustment) page 15



- To adjust flickering and position
[Screen]..... see [page 15](#)
- To adjust color gradation automatically
[Range] see [page 17](#)

2 Screen Adjustment (Advanced Adjustment) page 16

[Adjustment menu]

[At analog signal input]

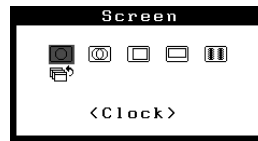

[At digital signal input]

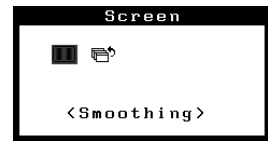

- To eliminate vertical bars [Clock*] ... see [page 16](#)
 - To remove flickering or blurring
[Phase*]..... see [page 16](#)
 - To correct screen position
[Hor. Position*] see [page 17](#)
[Ver. Position*] see [page 17](#)
 - To modify blurred characters/lines
[Smoothing] see [page 17](#)
- * Items marked with * can be adjusted with analog input.

Color Adjustment page 18



- To select the display mode (FineContrast mode) see [page 18](#)
- “Brightness,” “Contrast,” “Temperature,” and “Gain” can be set for each mode (Custom/ EyeCare/Paper/Text/sRGB (S1703/S1903), Custom/EyeCare/Paper/sRGB/DICOM (S1933)). Settable functions vary with the display mode.

Resumption of Default Setting

- To reset color adjustment values
[Reset] see [page 22](#)

To make useful settings/adjustments

- Adjustment menu (Refer to below for operation)

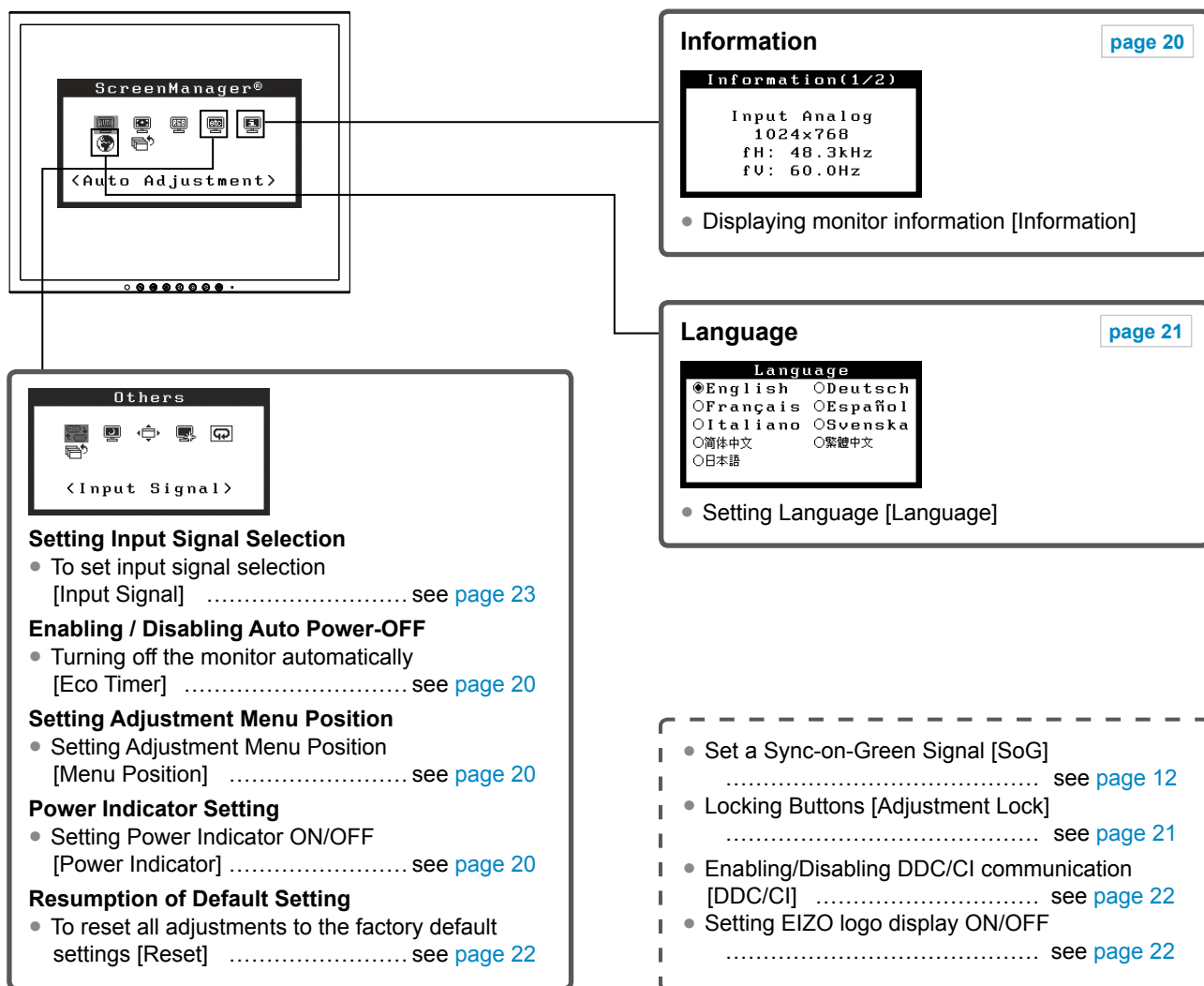

- Set a Sync-on-Green Signal [SoG] see [page 12](#)
- Locking Buttons [Adjustment Lock] see [page 21](#)
- Enabling/Disabling DDC/CI communication [DDC/CI] see [page 22](#)
- Setting EIZO logo display ON/OFF see [page 22](#)

Basic operation of Adjustment menu

[Displaying Adjustment menu and selecting function]

- (1) Press ●. The main menu appears.
- (2) Select a function with ◀ or ▶, and press ●. The sub menu appears.
- (3) Select a function with ◀ or ▶, and press ●. The adjustment/setting menu appears.
- (4) Adjust the selected item with ◀ or ▶, and press ●. The setting is saved.

[Exiting Adjustment menu]

- (1) Choose <Return> from the sub menu and press ●.
- (2) Choose <Exit> from the main menu and press ●.







NOTE

- The Adjustment menu can also be exited by pressing ● twice quickly.

Chapter 2 Settings and Adjustments

2-1 Set a Sync-on-Green Signal

When inputting a sync-on-green signal, the [SoG] setting for the monitor must be changed in advance according to the procedure below (for analog signal).

- (1) Press  to turn off the monitor.
- (2) Press  holding  down to turn on the monitor.
- (3) Select “On” with  or , and press .

2-2 Setting Screen Resolution

Compatible Resolutions/Frequencies

The monitor supports the following resolutions.

Analog Input

Resolution	Frequency	Dot Clock
640 × 480 (VGA, VESA)	~75 Hz	135 MHz (Max.)
720 × 400 (VGA TEXT)	70 Hz	
800 × 600 (VESA)	~75 Hz	
1024 × 768 (VESA)	~75 Hz	
1152 × 864 (VESA)	75 Hz	
1280 × 960 (VESA)	60 Hz	
1280 × 1024 (VESA)*	~75 Hz	

Digital Input

Resolution	Frequency	Dot Clock
640 × 480 (VGA)	60 Hz	108 MHz (Max.)
720 × 400 (VGA TEXT)	70 Hz	
800 × 600 (VESA)	60 Hz	
1024 × 768 (VESA)	60 Hz	
1280 × 1024 (VESA)*	60 Hz	

* Recommended resolution (Set this resolution)

Setting Resolution

When you connect the monitor to the PC and find that the resolution is improper, or when you want to change the resolution, follow the procedure below.

- **Windows 8 / Windows 7**

1. For Windows 8, click the “Desktop” tile on the Start Screen to display the desktop.
2. Right-click the mouse anywhere on the desktop except for icons.
3. From the displayed menu, click “Screen resolution”.
4. On the “Screen Resolution” dialog box, select the monitor.
5. Click “Resolution” to select the desired resolution.
6. Click the “OK” button.
7. When a confirmation dialog box is displayed, click “Keep changes”.

- **Windows Vista**

1. Right-click the mouse anywhere on the desktop except for icons.
2. From the displayed menu, click “Personalize”.
3. On the “Personalization” window, click “Display Settings”.
4. On the “Display Settings” dialog box, select the “Monitor” tab and select desired resolution in the “Resolution” field.
5. Click the “OK” button.
6. When a confirmation dialog box is displayed, click “Yes”.

- **Windows XP**

1. Right-click the mouse anywhere on the desktop except for icons.
2. From the displayed menu, click “Properties”.
3. When the “Display Properties” dialog box is displayed, click the “Settings” tab and select desired resolution for “Screen resolution” under “Display”.
4. Click the “OK” button to close the dialog box.

- **Mac OS X**

1. Select “System Preferences” from the Apple menu.
2. When the “System Preferences” dialog box is displayed, click “Displays” for “Hardware”.
3. On the displayed dialog box, select the “Display” tab and select desired resolution in the “Resolutions” field.
4. Your selection will be reflected immediately. When you are satisfied with the selected resolution, close the window.

2-3 Utility Disk

An “EIZO LCD Utility Disk” (CD-ROM) is supplied with the monitor. The following table shows the disk contents and the overview of the application software programs.

- **Disk contents and software overview**

The disk includes software programs for adjustment, and User’s Manual. Refer to “Readme.txt” file on the disk for software startup procedures or file access procedures.

Item	Overview	Windows	Macintosh
Screen adjustment pattern files	Used when adjusting the image of analog signal input manually.	√	√
ScreenManager Pro for LCD (DDC/CI)	Software for adjusting the screen using the mouse and keyboard.	√	-
EIZO ScreenSlicer	Software that divides a screen and lays out multiple windows efficiently.	√	-
User’s Manual of this monitor (PDF file)		√	√
Readme.txt file		√	√

- **To use ScreenManager Pro for LCD (DDC/CI)/EIZO ScreenSlicer**

For the installation and use of ScreenManager Pro for LCD (DDC/CI)/EIZO ScreenSlicer, refer to the respective User’s Manual on the disc.

2-4 Screen Adjustment

Digital Input

When digital signals are input, images are displayed correctly based on the preset data of the monitor, but if characters and/or lines appear blurred, go to step 6 “• To modify blurred characters/lines [Smoothing]” (page 17). When performing more advanced adjustment, see “2-5 Color Adjustment” (page 18) and subsequent pages.

Analog Input

The monitor screen adjustment is used to suppress flickering of the screen or adjust screen position and screen size correctly according to the PC to be used. To use the monitor comfortably, adjust the screen when the monitor is set up for the first time or when the settings of the PC in use are updated.





The Self Adjust function works when all of the following conditions are satisfied.

- When a signal is input into the monitor for the first time or when the resolution or Vertical/Horizontal Frequency not displayed before is set
- When signals with the vertical resolution over 480 are input

If the screen is not displayed correctly even after performing the Self Adjust operation, adjust the screen according to the procedures on the following pages to use the monitor comfortably.

[Adjustment Procedure]

1 Perform the auto adjustment.

- To adjust flickering, screen position, and screen size automatically [Screen]
 - (1) Choose <Screen> from the <Auto Adjustment> menu, and press .
 - The <Auto Adjustment> menu appears.
 - (2) Select “Execute” with  or , and press .
 - Flickering, screen position, and screen size are corrected by the auto-adjustment function.

If the screen is not displayed correctly even after adjusting in step 1 above, perform the adjustments according to the procedures on the following pages. When the screen is displayed correctly, go to step 5 “• To adjust color gradation automatically [Range]” (page 17).

2 Prepare the display pattern for the analog display adjustment.

Load the “EIZO LCD Utility Disk” to your PC, and then open the “Screen adjustment pattern files”.

Attention

- Wait 30 minutes or more from monitor power on before starting adjustments. (Allow the monitor to warm up for at least 30 minutes before making adjustments.)
- The self adjustment (or automatic screen adjustment) function works correctly when an image is fully displayed over the Windows or Macintosh display area. They do not work properly in the cases below:
 - When an image is displayed only on a part of the screen (command prompt window, for example)
 - When a black background (wallpaper, etc.) is in useAlso, these functions cannot work properly in some graphic boards.

NOTE

- For details and instructions on opening the “Screen adjustment pattern files”, refer to the “Readme.txt” file.

3 Perform the auto adjustment again with the analog screen adjustment pattern displayed.

- **To adjust flickering, screen position, and screen size automatically [Screen]**

- (1) Display Pattern 1 of the “Screen adjustment pattern files” in full screen on the monitor.

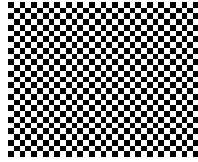

- (2) Choose <Screen> from the <Auto Adjustment> menu, and press .
The <Auto Adjustment> menu appears.
- (3) Select “Execute” with or , and press .
Flickering, screen position, and screen size are corrected by the auto-adjustment function.

If the screen is not displayed correctly even after adjusting in step 3 above, perform the adjustments according to the procedures on the following pages. When the screen is displayed correctly, go to step 5 “• To adjust color gradation automatically [Range]” (page 17).

4 Perform advanced adjustments for the following using the <Screen> menu of the Adjustment menu.

Adjust the clock, phase and position, in this order.

- **To eliminate vertical bars [Clock]**

- (1) Choose <Clock> from the <Screen> menu, and press .
The <Clock> menu appears.
- (2) Adjust the clock with or , and press .
The adjustment is completed.

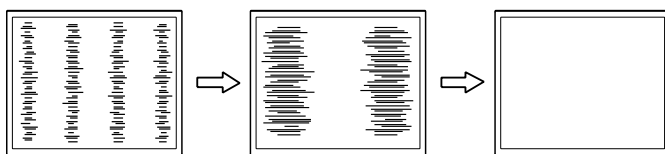

- **To remove flickering or blurring [Phase]**

Adjustable range: 0 to 63

- (1) Choose <Phase> from the <Screen> menu, and press .
The <Phase> menu appears.
- (2) Adjust the phase with or , and press .
The adjustment is completed.

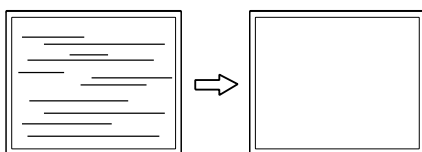

NOTE

- Press the control button slowly so as not to miss the adjustment point.
- When blurring, flickering or bars appear on the screen after adjustment, proceed to “• To remove flickering or blurring [Phase]” (page 16) to remove flickering or blurring.



Attention

- Flickering or blurring may not be eliminated depending on your PC or graphics board.

NOTE

- When vertical bars appear on the screen after adjustment, go back to “• To eliminate vertical bars [Clock]” (page 16). (Clock → Phase → Position)

- **To correct screen position [Hor. Position], [Ver. Position]**

- (1) Choose <Hor. Position> and or <Ver. Position> from the <Screen> menu, and press .
The <Hor. Position> or <Ver. Position> menu appears.
- (2) Adjust the position with  or  to display the image properly in the display area of the monitor.
The adjustment is completed.

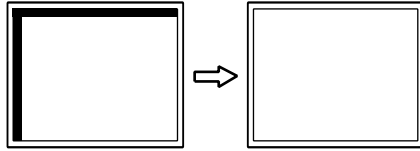





5 Adjust the color gradation.

- **To adjust color gradation automatically [Range]**

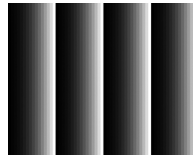
Every color gradation (0 to 255) can be displayed by adjusting the signal output level.

- (1) Display Pattern 2 in full screen on the monitor using the “Screen adjustment pattern files”.







- (2) Choose <Range> from the <Auto Adjustment> menu, and press .
- (3) Select “Execute” with  or , and press .
- (4) Close the Pattern 2.

6 Modify blurred characters or lines.

- **To modify blurred characters/lines [Smoothing]**

When a image is displayed with a resolution other than the recommendation, the characters or lines of the displayed image may be blurred.

Adjustable range: 1 to 5

- (1) Choose <Smoothing> from the <Screen> menu, and press .
- (2) Adjust the characters/lines with  or , and press .

NOTE

- Since the number of pixels and the pixel positions are fixed on the LCD monitor, only one position is provided to display images correctly. The position adjustment is made to shift an image to the correct position.





2-5 Color Adjustment

• To select the display mode (FineContrast mode)

This function allows you to select the best display mode for monitor brightness, etc.

FineContrast mode

Mode	Purpose
Custom	Available for making desired setting.
EyeCare	Allows the brightness to be set lower than possible with other modes.
Paper	Produces a printed paper effect. Suitable for displaying images from media such as books and documents.
Text (S1703/S1903)	Suitable for displaying texts for word processing or spreadsheets.
sRGB	Suitable for color matching with sRGB compatible peripherals.
DICOM (S1933)	Selected for the display in the DICOM mode.

- Choose <Color> from the Adjustment menu, and press .
- Choose <Color Mode> from the <Color> menu, and press .
The <Color Mode> menu appears.
- Select the mode with  or , and press .
The setting completes.





• To perform advanced adjustments

Independent setting and saving of color adjustment are available for each FineContrast mode.

• Adjustment items in each mode

According to the FineContrast mode selected, the adjustable function differs.

√ : Adjustment available – : Invalid for adjustment





Icon	Function	FineContrast mode					
		Custom	EyeCare	Paper	Text (S1703/S1903)	sRGB	DICOM (S1933)
	Brightness	√	√	√	√	√	–
	Contrast	√	–	–	√	–	–
	Temperature	√	√	–	√	–	–
	Gain	√	√	–	–	–	–
	Reset	√	√	√	√	√	–

NOTE

- “ScreenManager Pro for LCD (DDC/CI)” allows you to select the FineContrast mode automatically according to the application used. (Refer to “Chapter 3 Auto FineContrast” on the User’s Manual for “ScreenManager Pro for LCD (DDC/CI)”.)

Attention

- Wait 30 minutes or more from monitor power on before starting adjustments.
- Perform the range adjustment first when adjusting color for analog input signals. (Refer to “• To adjust color gradation automatically [Range]” (page 17).)
- The same image may be seen in different colors on multiple monitors due to their monitor-specific characteristics. Make fine color adjustment visually when matching colors on multiple monitors.

Menu	Description	Adjustment range
Brightness 	To adjust the full screen brightness as desired	0 to 100%
	NOTE <ul style="list-style-type: none"> • Values shown in percentage are available only as reference. • You can also adjust the brightness by pressing ◀ or ▶ button while the adjustment menu is not displayed. Press ● after adjustment. • If you feel that the image is too dark even if the brightness is set to 100%, adjust the contrast. 	
Contrast 	To adjust the contrast of the image	0 to 100%
	NOTE <ul style="list-style-type: none"> • Values shown in percentage are available only as reference. • In the contrast of 50%, every color gradation is displayed. • When adjusting the monitor, it is recommended to perform the brightness adjustment which may not lose the gradation characteristics, prior to the contrast adjustment. • Perform the contrast adjustment in the following cases. <ul style="list-style-type: none"> – When you feel the image is too dark even if the brightness is set to 100% (Set the contrast to higher than 50%.) 	
Temperature 	To select a color temperature	Off, 5000K, 6500K, 9300K
	NOTE <ul style="list-style-type: none"> • Setting the value to “Off” presents the natural color of the panel. • The values shown in the Kelvin (K) are available only as reference. 	
Gain 	To adjust red, green, and blue to a desired color tone respectively	0 to 100% Adjust the respective brightness of red/green/blue to make a desired color tone. Display an image with white or gray background for adjustment.
	Attention <ul style="list-style-type: none"> • This function does not enable to display every color gradation. 	
	NOTE <ul style="list-style-type: none"> • Values shown in percentage are available only as reference. • When using the <Gain> setting, the <Temperature> setting is set to “Off”. • The gain value may change depending on the value of the color temperature. 	
Reset 	To reset the color settings of the selected FineContrast mode to the default settings	

NOTE

- Using the “ScreenManager Pro for LCD (DDC/CI)” allows you to perform the color adjustment by using the mouse and keyboard of your PC. The adjusted status can be registered as a color data and restore the data later. (Refer to “Chapter 4 Color Adjustment” on the User’s Manual for “ScreenManager Pro for LCD (DDC/CI)”.)







• **To set/adjust color**

- (1) Choose <Color> from the Adjustment menu, and press ●.
- (2) Select a desired function from the <Color> menu, and press ●.
The selected function menu appears.
- (3) Adjust the selected item with ◀ or ▶, and press ●.
The adjustment is completed.

2-6 Turning off the monitor automatically [Eco Timer]





This function allows you to specify whether to turn on / off the monitor automatically after a specified time has elapsed in the power saving mode.

Adjustable range: Disable, Enable (0, 1, 2, 3, 5, 10, 15, 20, 25, 30, 45 min, 1-5h)

- (1) Choose <Others> from the Adjustment menu, and press .
- (2) Choose <Eco Timer> from the <Others> menu, and press .
The <Eco Timer> menu appears.
- (3) Select “Enable” or “Disable” with  or .
When selecting “Enable”, set a monitor Off time with  or .
- (4) Press .
The setting is completed.





2-7 Setting Adjustment Menu Position [Menu Position]

Adjust the menu position using the following procedure.

- (1) Choose <Others> from the Adjustment menu, and press .
- (2) Choose <Menu Position> from the <Others> menu, and press .
The <Menu Position> menu appears.
- (3) Select a menu position with  or , and press .
The setting is completed.

2-8 Setting Power Indicator ON/OFF [Power Indicator]

This function allows you to set the power indicator (blue) ON/OFF in the monitor ON condition.

- (1) Choose <Others> from the Adjustment menu, and press .
- (2) Choose <Power Indicator> from the <Others> menu, and press .
The <Power Indicator> menu appears.
- (3) Select “Enable” or “Disable” with  or , and press .
The setting is completed.



2-9 Displaying Monitor Information [Information]

This function allows you to display the input signal status, current resolution and model name.

Information 1/3 : Input signal status, resolution and H/V frequency

Information 2/3 : Enable/Disable setting for DDC/CI, On/Off setting for SoG (Sync-on-Green)

Information 3/3 : Model name, serial number and usage time

- (1) Choose <Information> from the Adjustment menu, and press .
The <Information> menu appears.
- (2) Then, press  to check settings, etc.

NOTE





- The usage time is not always “0” when you purchase the monitor due to factory inspection.

2-10 Setting Language [Language]

This function allows you to select a language for the adjustment menu or displaying message.





Selectable languages

English, German, French, Spanish, Italian, Swedish, Simplified Chinese, Traditional Chinese, Japanese

- (1) Choose <Language> menu from the Adjustment menu, and press .
The <Language> menu appears.
- (2) Choose a language with  or , and press .
The setting is completed.

2-11 Setting On/Off for the automatic brightness adjustment function [Auto EcoView]

The sensor on the front side of the monitor detects the environmental brightness to adjust the screen brightness automatically and comfortably by using the Auto EcoView function.

- (1) Press .
The <Auto EcoView> menu appears.
- (2) Select “On” or “Off” with  or , and press .
The setting is completed.

2-12 Displaying the level of power saving by EcoView Index

This indicator shows the power saving ratio, power reduction and CO₂ reduction as a result of the brightness of the monitor.

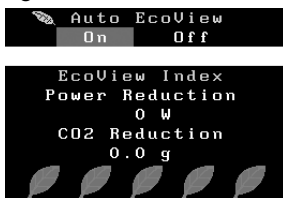

- (1) Press .
The EcoView Index menu appears.
The power saving ratio comes to high as the indicator level meter lights towards right.



2-13 Locking Buttons

This function allows you to lock to prevent changing the adjusted/set status.

• To lock adjustments/settings in the Adjustment menu

- (1) Press  to turn off the monitor.
- (2) Press  holding  down to turn on the monitor.
The Lock/Unlock setting is toggled by performing the operation in step 2.

NOTE

- Be careful not to block the sensor on the lower side of the monitor when using the Auto EcoView function.
- When “DICOM” is selected for the color mode, the Auto EcoView setting is turned “Off” (S1933).

NOTE

Power reduction: the backlight's reduction of electricity consumption as a result of the adjusted brightness value
CO₂ reduction: converted from the “Power reduction” value, this is an estimate of the quantity of CO₂ emissions reduced when using the monitor for 1 hour.



* The numeric value is a result of a calculation based on a default setting (0.000555 t -CO₂/kWh) determined by a Japanese ministerial ordinance (2006, Ministry of Economy, Trade and Industry, Ministry of Environment, civil code article 3) and may differ depending on country and year.

NOTE

- The following operations are available even if the buttons are locked:
 - Turning on or off the monitor with the Power button

2-14 Enabling/Disabling DDC/CI communication



This function allows you to enable/disable the DDC/CI communication.

- (1) Press  to turn off the monitor.
- (2) Press  holding  down to turn on the monitor.

The Enable/Disable setting is toggled by performing the operation in step 2.

2-15 Setting EIZO logo display ON/OFF

The EIZO logo appears on the display when turning on the monitor. This function allows you to display, or not, the EIZO logo.

- (1) Press  to turn off the monitor.
- (2) Press  holding  down to turn on the monitor.





The EIZO logo display setting is toggled by performing the operation in step 2.

2-16 Resuming the Default Setting [Reset]

There are two types of Reset. One is to reset the color adjustment only to the default settings, and the other is to reset all the settings to the default settings.

• To reset color adjustment values





Only the adjustment values in the current FineContrast mode will revert to the default settings (factory settings).

- (1) Choose <Color> from the Adjustment menu, and press .
- (2) Choose <Reset> from the <Color> menu and press .
- (3) Select “Reset” with  or , and press .

The color adjustment values revert to the default settings.

• To reset all adjustments to the factory default settings

Reset all adjustments to the factory default settings.

- (1) Choose <Others> from the Adjustment menu, and press .
- (2) Choose <Reset> from the <Others> menu, and press .
- (3) Select “Reset” with  or , and press .

All setting values revert to the default settings.

NOTE

- You can check the DDC/CI setting in the <Information> menu.

Attention

- After resetting, you cannot undo the operation.

NOTE

- For default settings, refer to “[Main default settings \(factory settings\)](#)” (page 32).

Chapter 3 Connecting Cables

3-1 Connecting Multiple PCs to the Monitor

Multiple PCs can be connected to the DVI-D, D-Sub mini 15 pin connector on the back of the monitor to switch the display.

Connection examples

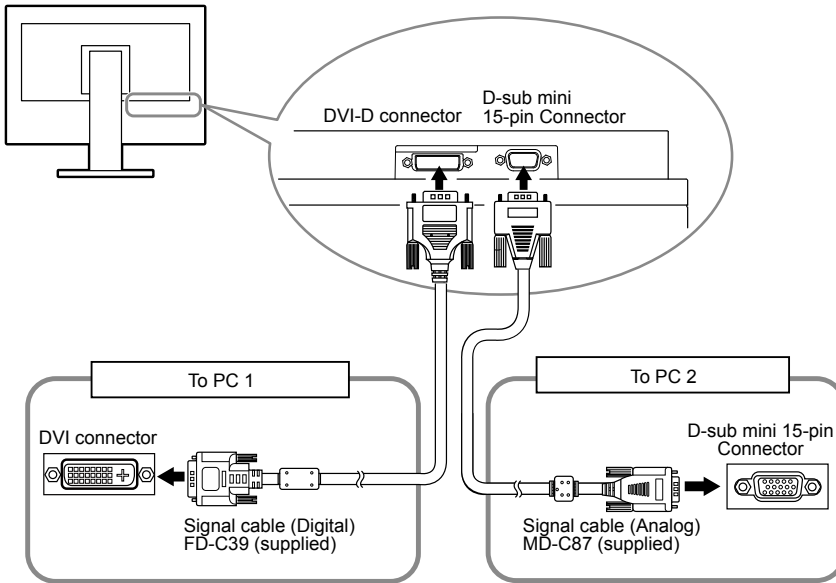

• To switch the input signal

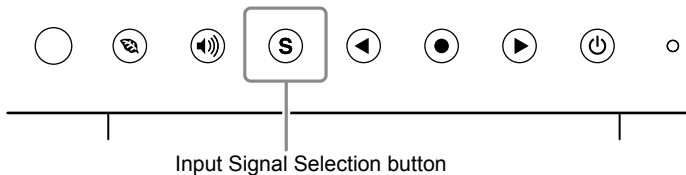

Switch the input signal with **(S)**. Input signal switches each time **(S)** is pressed. When the signal is switched, the active signal type (Analog or Digital) appears at the top right corner of the screen for three seconds.

• To set input signal selection [Input Signal]

Setting	Function
Auto	When a PC is turned off or enters the powersaving mode, the monitor automatically displays another signal.
Manual	The monitor detects only the PC's signals currently displaying automatically. Select the input signal for display using the (S) operation button.

NOTE

- When “Auto” is selected for <Input Signal>, the monitor’s power-saving function works only when the two PCs are in the power-saving mode.





[Procedure]

- (1) Choose <Others> from the Adjustment menu, and press **(●)**.
- (2) Choose <Input Signal> from the <Others> menu, and press **(●)**.
The <Input Signal> menu appears.
- (3) Select “Auto” or “Manual” with **(◀)** or **(▶)**, and press **(●)**.
The setting is completed.

Chapter 4 Troubleshooting

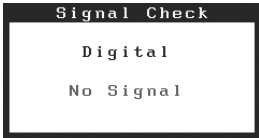
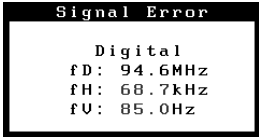
If a problem still remains after applying the suggested remedies, contact your local EIZO representative.

- No-picture problems → See No.1 - No.2.
- Imaging problems (digital input) → See No.6 - No.11.
- Imaging problems (analog input) → See No.3 - No.11.
- Other problems → See No.12 - No.14.

Problems	Possible cause and remedy
<p>1. No picture</p> <ul style="list-style-type: none"> • Power indicator does not light. <hr/> <ul style="list-style-type: none"> • Power indicator is lighting blue. <hr/> <ul style="list-style-type: none"> • Power indicator is lighting orange. 	<ul style="list-style-type: none"> • Check whether the power cord is connected correctly. • If the problem persists, turn off the monitor, and then turn it on again a few minutes later. <hr/> <ul style="list-style-type: none"> • Set each adjusting value in <Brightness>, <Contrast> and <Gain> to higher level. (page 19) <hr/> <ul style="list-style-type: none"> • Switch the input signal with (S). • Move the mouse or press any key on the keyboard. • Turn on the PC.
<p>2. The message below appears.</p> <ul style="list-style-type: none"> • This message appears when no signal is input. Example:  <p style="text-align: center;">Signal Check Digital No Signal</p> <hr/> <ul style="list-style-type: none"> • The message below shows that the input signal is out of the specified frequency range. (Such signal frequency is displayed in red.) Example:  <p style="text-align: center;">Signal Error Digital fD : 94.6MHz fH : 68.7kHz fV : 85.0Hz</p>	<p>This message appears when the signal is not input correctly even when the monitor functions properly.</p> <hr/> <ul style="list-style-type: none"> • The message shown left may appear, because some PCs do not output the signal soon after power-on. • Check whether the PC is turned on. • Check whether the signal cable is connected properly. • Switch the input signal with (S). • When inputting a sync-on-green signal, the [SoG] setting for the monitor must be changed in advance (for analog signal). (page 12) <hr/> <ul style="list-style-type: none"> • Check whether the signal setting of your PC matches the resolution and the vertical frequency settings for the monitor. (page 12) • Reboot the PC. • Select an appropriate setting using the graphics board's utility. Refer to the User's Manual of the graphics board for details. <p style="margin-left: 20px;">fD : Dot Clock (Displayed only when the digital signal inputs) fH : Horizontal Frequency fV : Vertical Frequency</p>
<p>3. Display position is incorrect.</p> 	<ul style="list-style-type: none"> • Adjust image position so that it is displayed properly within the display area using the <Hor.Position> and <Ver.Position> adjustment. • If the problem persists, use the graphics board's utility software if available to change the display position.
<p>4. Vertical bars appear on the screen or a part of the image is flickering.</p> 	<ul style="list-style-type: none"> • Adjust using <Clock>. (page 16)
<p>5. Whole screen is flickering or blurring.</p> 	<ul style="list-style-type: none"> • Adjust using <Phase>. (page 16)

Problems	Possible cause and remedy
6. Characters are blurred.	<ul style="list-style-type: none"> • Check whether the signal setting of your PC matches the resolution and the vertical frequency settings for the monitor. (page 12) • Adjust using <Smoothing>. (page 17)
7. The screen is too bright or too dark.	<ul style="list-style-type: none"> • Adjust using <Brightness> or <Contrast>. (The LCD monitor backlight has a limited life span. When the screen becomes dark or begins to flicker, contact your local EIZO representative.) • If the screen is too bright, turn on Auto EcoView. (page 21) The monitor detects the environmental brightness to adjust the screen brightness automatically.
8. Afterimages appear.	<ul style="list-style-type: none"> • Afterimages are particular to LCD monitors. Avoid displaying the same image for a long time. • Use the screen saver or power save function to avoid displaying the same image for extended periods of time.
9. Green/red/blue/white dots or defective dots remain on the screen.	<ul style="list-style-type: none"> • This is due to LCD panel characteristics and is not a failure.
10. Interference patterns or pressure marks remain on the screen.	<ul style="list-style-type: none"> • Leave the monitor with a white or black screen. The symptom may disappear.
11. The display image is appeared in lengthwise.	<ul style="list-style-type: none"> • Check whether the kind of cables connected with the monitor and the PC. (Re-connect the monitor and cables correctly by referring to the Setup Guide.)
12. The adjustment menu does not appear.	<ul style="list-style-type: none"> • Check whether the operation lock function is active. (page 21)
13. The auto-adjustment function does not work correctly.	<ul style="list-style-type: none"> • This function does not work when digital signal is input. • This function works correctly when an image is fully displayed over the display area. It does not work properly when an image is displayed only on a part of the screen (DOS prompt window, for example) or when a black background (wallpaper, etc.) is in use. This function does not work correctly with some graphics boards.
14. No audio output	<ul style="list-style-type: none"> • Check whether the mini jack cable is correctly. • Check whether volume is set to "0". • Check the settings of the PC and the audio playback software.

Chapter 5 Reference

5-1 How to Attach the Optional Arm

An optional arm (or an optional stand) can be attached by removing the stand section. Please refer to our web site for the corresponding optional arm (or optional stand).

<http://www.eizo.com>

[Attaching]

1 Lay the LCD monitor on a soft cloth spread over on a stable surface with the panel surface facing down.

2 Remove the stand. (Prepare a screwdriver.)

Unscrew the four screws securing the unit and the stand with the screwdriver.

3 Attach the monitor to the arm or stand.

Secure the monitor to the arm or stand using the screws specified in the user's manual of the arm or stand.

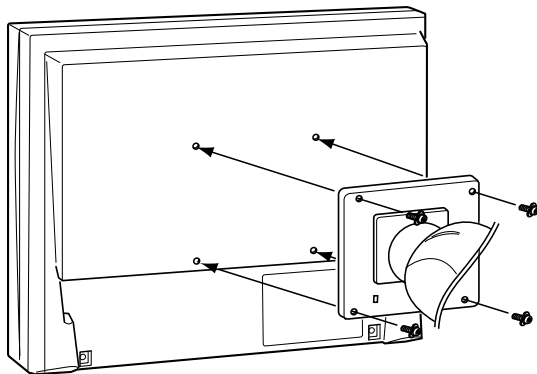

Attention

- When attaching an arm or stand, follow the instructions of their user's manual.
- When using another manufacturer's arm or stand, confirm the following in advance and select one conforming to the VESA standard. Use M4 × 12 mm screws supplied with the monitor.
 - Clearance between the screw holes: 100 mm × 100 mm
 - Thickness of plate: 2.6 mm
 - Strong enough to support weight of the monitor unit (except the stand) and attachments such as cables.
- When using an arm or stand, attach it to meet the following tilt angles of the monitor.
 - Up 60 degrees, down 45 degrees (horizontal display)
 - Up 45 degrees, down 45 degrees (vertical display, 90 degrees clockwise)
- Connect the cables after attaching an arm or a stand.

5-2 Power Saving Mode

■ Analog input

This monitor complies with the VESA DPMS standard.

[Power Saving System]

PC		Monitor	Power Indicator
Operating		Operating	Blue
Power saving	STAND-BY SUSPENDED OFF	Power saving	Orange

■ Digital input

This monitor complies with the DVI DMPM standard.

[Power Saving System]

The monitor enters the power saving mode in five seconds in connection with the PC setting.

PC	Monitor	Power Indicator
Operating	Operating	Blue
Power saving	Power saving	Orange

Attention

- Unplugging the power cord completely shuts off power supply to the monitor.
- Power consumption varies even when the stereo mini jack cable is connected.

5-3 Specifications

S1703

LCD Panel		17.0-inch (43 cm) TFT color LCD with Anti-Glare Hard coating, LED backlight Viewing angle: Horizontal 170°, Vertical 160° (CR: 10 or more)
Dot Pitch		0.264 mm
Horizontal Scan Frequency		Analog: 31 - 80 kHz Digital: 31 - 64 kHz
Vertical Scan Frequency		Analog: 50 - 75 Hz (Non-interlace) Digital: 59 - 61 Hz (VGA Text: 69 - 71 Hz) (Non-interlace)
Resolution		1280 dots × 1024 lines
Max. Dot Clock		Analog: 135 MHz Digital: 108 MHz
Max. Display Colors		Approx. 16.77 million colors
Display Area (H × V)		337.9 mm × 270.3 mm
Power Supply		100 - 120 VAC ±10% 50/60 Hz, 0.45 A 200 - 240 VAC ±10% 50/60 Hz, 0.3 A
Power Consumption	Screen Display On	25W or less (Speaker working)
	Power saving mode	0.5W or less (for single signal input, when stereo mini jack cable is not connected, [Input Signal] : "Auto", [SoG] : "Off")
	Power button Off	0.5W or less (when stereo mini jack cable is not connected)
Input Signal Connectors		DVI-D connector, D-sub mini 15-pin connector
Analog Input Signal (Sync)		Separate, TTL, Positive/Negative Sync on Green, 0.3Vp-p, Negative
Analog Input Signal (Video)		Analog, Positive (0.7Vp-p/75Ω)
Digital Signal Transmission System		TMDS (Single Link)
Audio output		Speaker output: 0.5 W + 0.5 W (8 Ω, THD+N: 10% or less) Headphone output: 2mW + 2mW (32 Ω, THD+N: 3% or less)
Line input		Input impedance 47 kΩ (typ.) Input level: 1.0 Vrms (Max.)
Plug & Play		VESA DDC 2B/EDID structure 1.3
Dimensions (Width) × (Height) × (Depth)	Main unit	Tilt Stand : 367 mm (14.4 inch) × 384 mm (15.1 inch) × 188 mm (7.4 inch)
		Height adjustable Stand : 367 mm (14.4 inch) × 391.5 - 491.5 mm (15.4 - 19.4 inch) × 205 mm (8.1 inch)
	Without stand	367 mm (14.4 inch) × 304 mm (12 inch) × 59 mm (2.32 inch)
Mass	Main unit	Tilt Stand : Approx. 4.4 kg (9.7 lbs.)
		Height adjustable Stand : Approx. 5.5 kg (12.1 lbs)
	Without stand	Approx. 3.6 kg (7.9 lbs.)
Movable range	Tilt Stand	Tilt: 30° Up, 5° Down
	Height adjustable Stand	Tilt: 30° Up, 0° Down Swivel: 35° Right, 35° Left Adjustable height: 100 mm (3.9 inch) Rotation: 90° (clockwise)

Environmental Conditions	Temperature	Operating: 5°C to 35°C (41°F to 95°F)
		Transportation/Storage: -20°C to 60°C (-4°F to 140°F)
	Humidity	Operating: 20 % to 80 % R.H. (no condensation)
		Transportation/Storage: 10 % to 90 % R.H. (no condensation)
	Air Pressure	Operating: 700 to 1,060 hPa
		Transportation/Storage: 200 to 1,060 hPa

S1903

LCD Panel		19.0-inch (48 cm) TFT color LCD with Anti-Glare Hard coating, LED backlight Viewing angle: Horizontal 170°, Vertical 160° (CR: 10 or more)
Dot Pitch		0.294 mm
Horizontal Scan Frequency		Analog: 31 - 80 kHz Digital: 31 - 64 kHz
Vertical Scan Frequency		Analog: 50 - 75 Hz (Non-interlace) Digital: 59 - 61 Hz (VGA Text: 69 - 71 Hz) (Non-interlace)
Resolution		1280 dots × 1024 lines
Max. Dot Clock		Analog: 135 MHz Digital: 108 MHz
Max. Display Colors		Approx. 16.77 million colors
Display Area (H × V)		376.3 mm × 301.0 mm
Power Supply		100 - 120 VAC ±10% 50/60 Hz, 0.45 A 200 - 240 VAC ±10% 50/60 Hz, 0.3 A
Power Consumption	Screen Display On	23W or less (Speaker working)
	Power saving mode	0.5W or less (for single signal input, when stereo mini jack cable is not connected, [Input Signal] : "Auto", [SoG] : "Off")
	Power button Off	0.5W or less (when stereo mini jack cable is not connected)
Input Signal Connectors		DVI-D connector, D-sub mini 15-pin connector
Analog Input Signal (Sync)		Separate, TTL, Positive/Negative Sync on Green, 0.3Vp-p, Negative
Analog Input Signal (Video)		Analog, Positive (0.7Vp-p/75Ω)
Digital Signal Transmission System		TMDS (Single Link)
Audio output		Speaker output: 0.5 W + 0.5 W (8 Ω, THD+N: 10% or less) Headphone output: 2mW + 2mW (32 Ω, THD+N: 3% or less)
Line input		Input impedance 47 kΩ (typ.) Input level: 1.0 Vrms (Max.)
Plug & Play		VESA DDC 2B/EDID structure 1.3
Dimensions (Width) × (Height) × (Depth)	Main unit	Tilt Stand : 405 mm (15.9 inch) × 416 mm (16.4 inch) × 205 mm (8.1 inch)
		Height adjustable Stand : 405 mm (15.9 inch) × 406.5 - 506.5 mm (16 - 19.9 inch) × 205 mm (8.1 inch)
	Without stand	405 mm (15.9 inch) × 334 mm (13.1 inch) × 61.5 mm (2.42 inch)
Mass	Main unit	Tilt Stand : Approx. 4.9 kg (10.8 lbs.)
		Height adjustable Stand : Approx. 5.9 kg (13 lbs)
	Without stand	Approx. 4.1 kg (9 lbs.)
Movable range	Tilt Stand	Tilt: 30° Up, 5° Down
	Height adjustable Stand	Tilt: 30° Up, 0° Down Swivel: 35° Right, 35° Left Adjustable height: 100 mm (3.9 inch) Rotation: 90° (clockwise)
Environmental Conditions	Temperature	Operating: 5°C to 35°C (41°F to 95°F)
		Transportation/Storage: -20°C to 60°C (-4°F to 140°F)
	Humidity	Operating: 20 % to 80 % R.H. (no condensation)
		Transportation/Storage: 10 % to 90 % R.H. (no condensation)
	Air Pressure	Operating: 700 to 1,060 hPa
		Transportation/Storage: 200 to 1,060 hPa

S1933

LCD Panel		19.0-inch (48 cm) TFT color LCD with Anti-Glare Hard coating, LED backlight Viewing angle: Horizontal 178°, Vertical 178° (CR: 10 or more)
Dot Pitch		0.294 mm
Horizontal Scan Frequency		Analog: 31 - 80 kHz Digital: 31 - 64 kHz
Vertical Scan Frequency		Analog: 50 - 75 Hz (Non-interlace) Digital: 59 - 61 Hz (VGA Text: 69 - 71 Hz) (Non-interlace)
Resolution		1280 dots × 1024 lines
Max. Dot Clock		Analog: 135 MHz Digital: 108 MHz
Max. Display Colors		Approx. 16.77 million colors
Display Area (H × V)		376.3 mm × 301.0 mm
Power Supply		100 - 120 VAC ±10% 50/60 Hz, 0.45 A 200 - 240 VAC ±10% 50/60 Hz, 0.3 A
Power Consumption	Screen Display On	24W or less (Speaker working)
	Power saving mode	0.5W or less (for single signal input, when stereo mini jack cable is not connected, [Input Signal] : "Auto", [SoG] : "Off")
	Power button Off	0.5W or less (when stereo mini jack cable is not connected)
Input Signal Connectors		DVI-D connector, D-sub mini 15-pin connector
Analog Input Signal (Sync)		Separate, TTL, Positive/Negative Sync on Green, 0.3Vp-p, Negative
Analog Input Signal (Video)		Analog, Positive (0.7Vp-p/75Ω)
Digital Signal Transmission System		TMDS (Single Link)
Audio output		Speaker output: 0.5 W + 0.5 W (8 Ω, THD+N: 10% or less) Headphone output: 2mW + 2mW (32 Ω, THD+N: 3% or less)
Line input		Input impedance 47 kΩ (typ.) Input level: 1.0 Vrms (Max.)
Plug & Play		VESA DDC 2B/EDID structure 1.3
Dimensions (Width) × (Height) × (Depth)	Main unit	Tilt Stand : 405 mm (15.9 inch) × 416 mm (16.4 inch) × 205 mm (8.1 inch)
		Height adjustable Stand : 405 mm (15.9 inch) × 406.5 - 506.5 mm (16 - 19.9 inch) × 205 mm (8.1 inch)
	Without stand	405 mm (15.9 inch) × 334 mm (13.1 inch) × 61.5 mm (2.42 inch)
Mass	Main unit	Tilt Stand : Approx. 4.9 kg (10.8 lbs.)
		Height adjustable Stand : Approx. 5.9 kg (13 lbs)
	Without stand	Approx. 4.1 kg (9 lbs.)
Movable range	Tilt Stand	Tilt: 30° Up, 5° Down
	Height adjustable Stand	Tilt: 30° Up, 0° Down Swivel: 35° Right, 35° Left Adjustable height: 100 mm (3.9 inch) Rotation: 90° (clockwise)
Environmental Conditions	Temperature	Operating: 5°C to 35°C (41°F to 95°F)
		Transportation/Storage: -20°C to 60°C (-4°F to 140°F)
	Humidity	Operating: 20 % to 80 % R.H. (no condensation)
		Transportation/Storage: 10 % to 90 % R.H. (no condensation)
	Air Pressure	Operating: 540 to 1,060 hPa
		Transportation/Storage: 200 to 1,060 hPa

Main default settings (factory settings)

Auto EcoView	On
Smoothing	3
FineContrast Mode	Custom
Input Signal	Auto
Eco Timer	Disable
Language	English

Outside Dimensions

S1703

- Tilt Stand

unit : mm (inch)

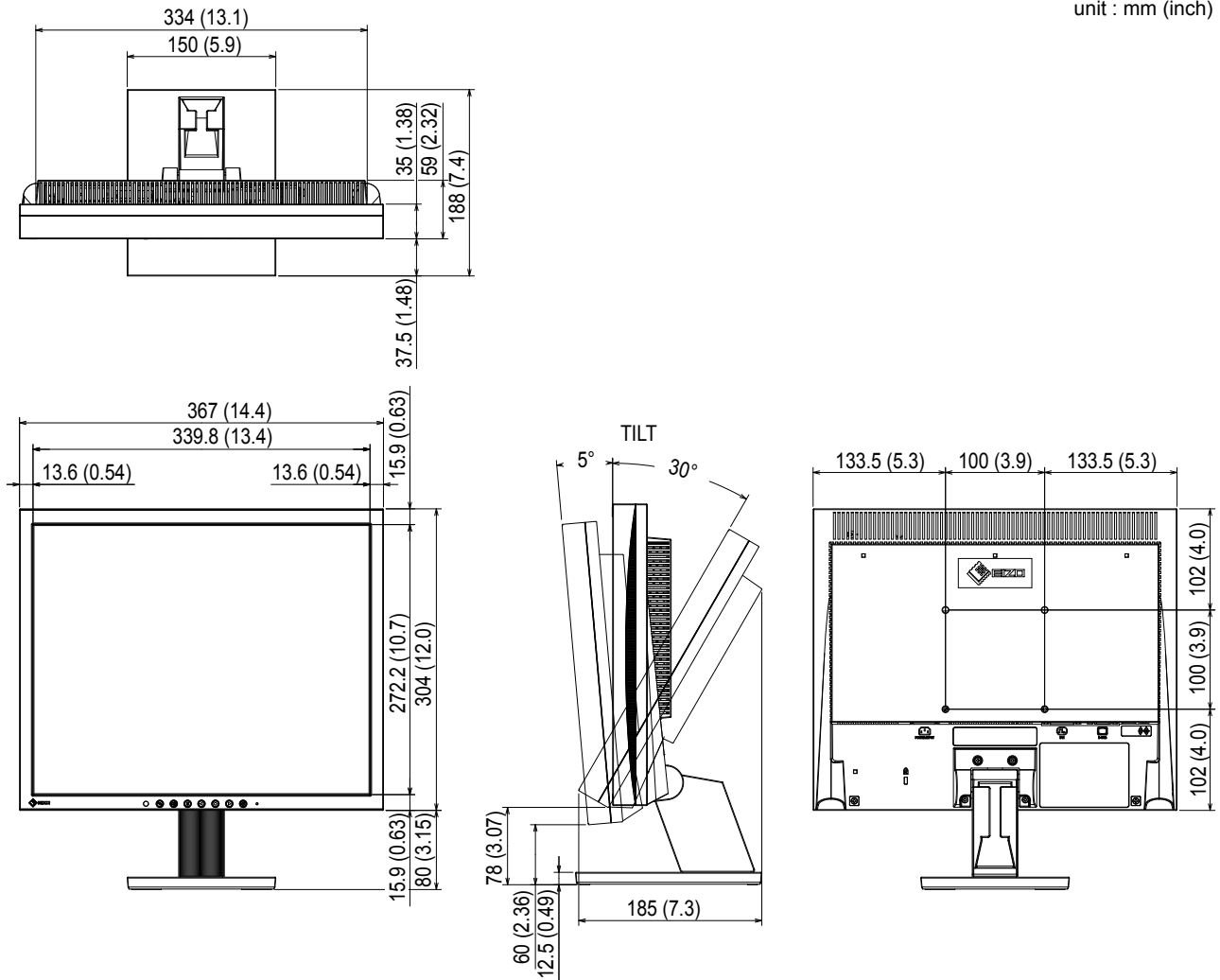

• Height adjustable Stand

unit : mm (inch)

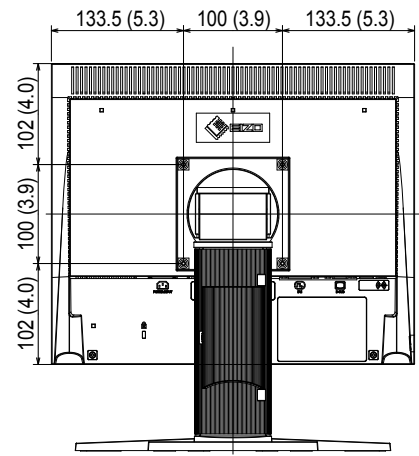
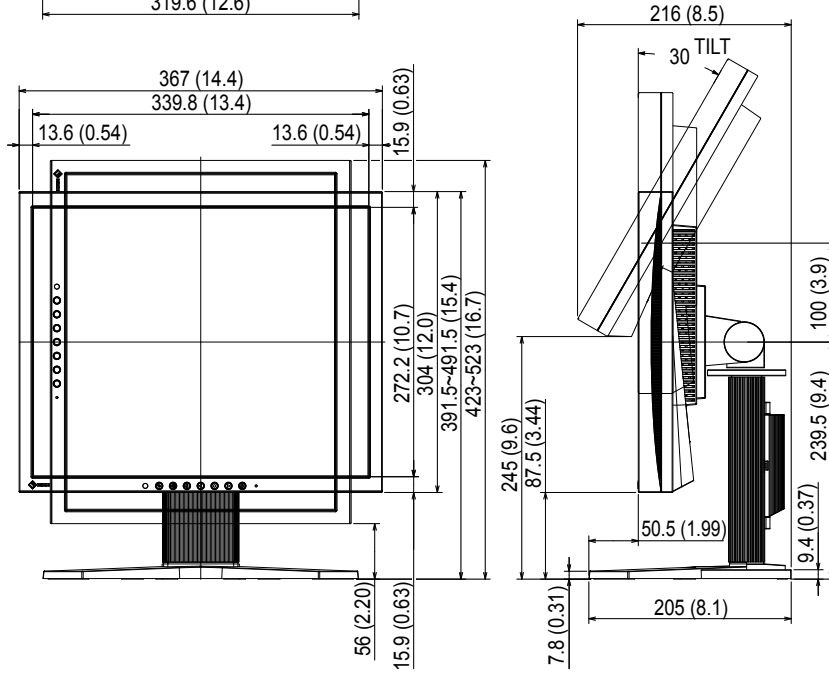
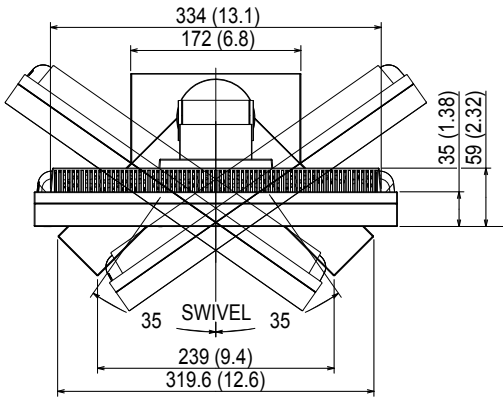

S1903 / S1933

- Tilt Stand

unit : mm (inch)

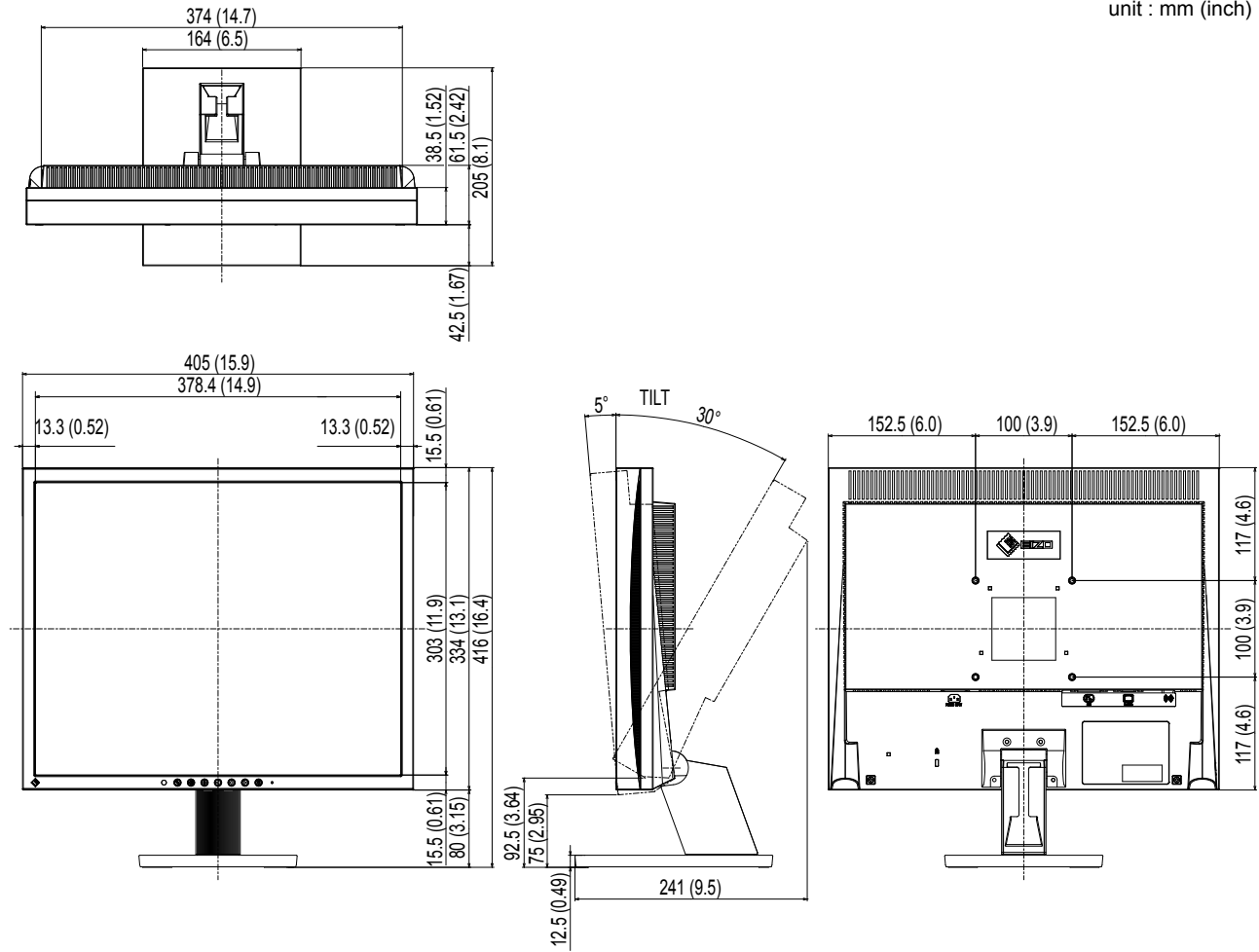

• Height adjustable Stand

unit : mm (inch)

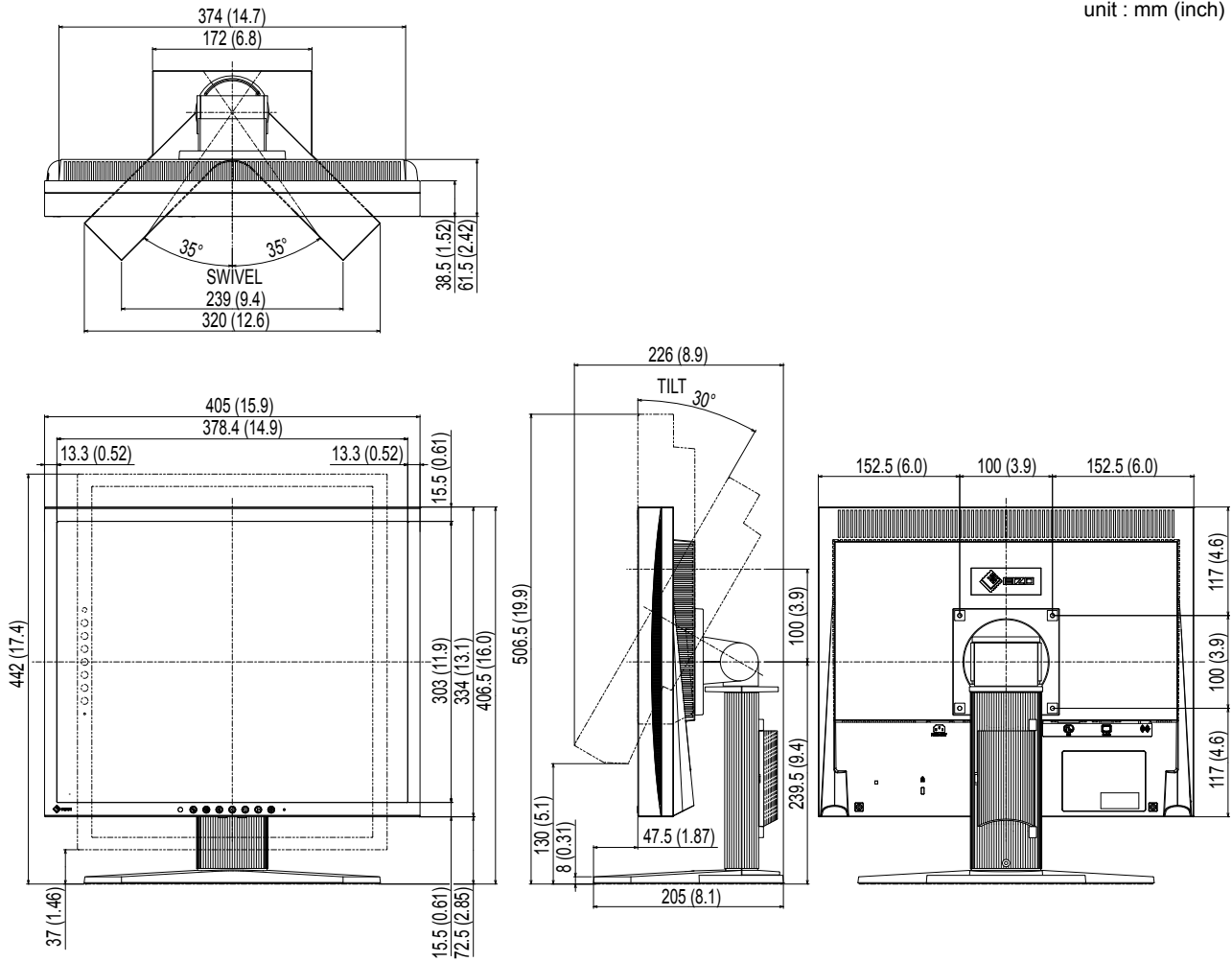

Option List

Cleaning Kit	EIZO ScreenCleaner
--------------	--------------------

For the latest information about the accessories, refer to our web site.

<http://www.eizo.com>

5-4 Glossary

Clock

The analog signal input monitor needs to reproduce a clock of the same frequency as the dot clock of the graphics system in use, when the analog signal is converted to a digital signal for image display. This is called clock adjustment. If the clock pulse is not set correctly, some vertical bars appear on the screen.

DDC/CI (Display Data Channel/Command Interface)

VESA provides the standardization for the interactive communication of the setting information, etc. between a PC and the monitor.

DICOM (Digital Imaging and Communication in Medicine)

The DICOM standard was developed by the American College of Radiology and the National Electrical Manufacturer's Association of the USA.

The DICOM compatible device connection enables to transfer the medical image and information. The DICOM, Part 14 document defines the digital, grayscale medical image display.

DVI (Digital Visual Interface)

DVI is a digital interface standard. DVI allows direct transmission of the PC's digital data without loss.

This adopts the TMDS transmission system and DVI connectors. There are two types of DVI connectors. One is a DVI-D connector for digital signal input only. The other is a DVI-I connector for both digital and analog signal inputs.

DVI DMPM (DVI Digital Monitor Power Management)

DVI DMPM is a digital interface power saving function. The "Monitor ON (operating mode)" and "Active Off (power saving mode)" are indispensable for DVI DMPM as the monitor's power mode.

Gain

This is used to adjust each color parameter for red, green and blue. An LCD monitor displays the color by the light passing through the panel color filter. Red, green and blue are the three primary colors. All the colors on the screen are displayed by combining these three colors. The color tone can be changed by adjusting the light intensity (volume) passing through each color's filter.

Phase

Phase means the sampling timing to convert the analog input signal to a digital signal. Phase adjustment is made to adjust the timing. It is recommended that phase adjustment be made after the clock is adjusted correctly.

Range Adjustment

Range adjustment controls the signal output levels to display every color gradation. It is recommended that range adjustment be made before color adjustment.

Resolution

The LCD panel consists of numerous pixels of specified size, which are illuminated to form images. This monitor consists of horizontal 1280 pixels and 1024 vertical pixels. At a resolution of 1280 × 1024, all pixels are illuminated as a full screen (1:1).

sRGB (Standard RGB)

International standard for color reproduction and color space among peripheral devices (such as monitors, printers, digital cameras, scanners). As a form of simple color matching for the Internet, colors can be displayed using tones close to those of the transmission and reception devices.

Sync-on-Green

A composite horizontal and vertical signal sync for the green signal in RGB. Typically, monitors use 5 signals, one for red, green and blue, and one for each horizontal and vertical sync. Sync-on-green monitors utilize three connections, one for red, one for blue and two synced horizontal and vertical signals that are counted as one green video signal.

Temperature

Color temperature is a method to measure the white color tone, generally indicated in degrees Kelvin. The screen becomes reddish at a low temperature, and bluish at a high temperature, like the flame temperature.

5000 K: Slightly reddish white

6500 K: White referred to as daylight-balanced color

9300 K: Slightly bluish white

TMD5 (Transition Minimized Differential Signaling)

A signal transmission system for digital interface.

VESA DPM (Video Electronics Standards Association - Display Power Management)

VESA specifications achieve increased energy efficiency for computer monitors. This involves standardization of signals sent from the computer (graphics board).

DPM defines the status of signals transmitted between the computer and monitor.

5-5 Preset Timing

The following table shows factory preset analog signal timing.

Mode	Dot clock		Frequency		Polarity
			Horizontal: kHz	Vertical: Hz	
VGA 640×480@60Hz	25.2 MHz	Horizontal	31.47	Negative	
		Vertical	59.94	Negative	
VGA TEXT 720×400@70Hz	28.3 MHz	Horizontal	31.47	Negative	
		Vertical	70.09	Positive	
VESA 640×480@75Hz	31.5 MHz	Horizontal	37.50	Negative	
		Vertical	75.00	Negative	
VESA 800×600@60Hz	40.0 MHz	Horizontal	37.88	Positive	
		Vertical	60.32	Positive	
VESA 800×600@75Hz	49.5 MHz	Horizontal	46.88	Positive	
		Vertical	75.00	Positive	
VESA 1024×768@60Hz	65.0 MHz	Horizontal	48.36	Negative	
		Vertical	60.00	Negative	
VESA 1024×768@75Hz	78.8 MHz	Horizontal	60.02	Positive	
		Vertical	75.03	Positive	
VESA 1152×864@75Hz	108.0 MHz	Horizontal	67.50	Positive	
		Vertical	75.00	Positive	
VESA 1280×960@60Hz	108.0 MHz	Horizontal	60.00	Positive	
		Vertical	60.00	Positive	
VESA 1280×1024@60Hz	108.0 MHz	Horizontal	63.98	Positive	
		Vertical	60.02	Positive	
VESA 1280×1024@75Hz	135.0 MHz	Horizontal	79.98	Positive	
		Vertical	75.03	Positive	

Attention

- Display position may be deviated depending on the PC connected, which may require screen adjustment using Adjustment menu.
- If a signal other than those listed in the table is input, adjust the screen using the Adjustment menu. However, screen display may still be incorrect even after the adjustment.
- When interlace signals are used, the screen cannot be displayed correctly even after screen adjustment using the Adjustment menu.

For U.S.A. , Canada, etc. (rated 100-120 Vac) Only

FCC Declaration of Conformity

We, the Responsible Party

EIZO Inc.

5710 Warland Drive, Cypress, CA 90630

Phone: (562) 431-5011

declare that the product

Trade name: EIZO

Model: FlexScan S1703/S1903/S1933

is in conformity with Part 15 of the FCC Rules. Operation of this product is subject to the following two conditions: (1) this device may not cause harmful interference, and (2) this device must accept any interference received, including interference that may cause undesired operation.

This equipment has been tested and found to comply with the limits for a Class B digital device, pursuant to Part 15 of the FCC Rules. These limits are designed to provide reasonable protection against harmful interference in a residential installation. This equipment generates, uses, and can radiate radio frequency energy and, if not installed and used in accordance with the instructions, may cause harmful interference to radio communications. However, there is no guarantee that interference will not occur in a particular installation. If this equipment does cause harmful interference to radio or television reception, which can be determined by turning the equipment off and on, the user is encouraged to try to correct the interference by one or more of the following measures.

- * Reorient or relocate the receiving antenna.
- * Increase the separation between the equipment and receiver.
- * Connect the equipment into an outlet on a circuit different from that to which the receiver is connected.
- * Consult the dealer or an experienced radio/TV technician for help.

Changes or modifications not expressly approved by the party responsible for compliance could void the user's authority to operate the equipment.

Note

Use the attached specified cable below or EIZO signal cable with this monitor so as to keep interference within the limits of a Class B digital device.

- AC Cord
- Shielded Signal Cable (enclosed)

Canadian Notice

This Class B digital apparatus complies with Canadian ICES-003.

Cet appareil numérique de la classe B est conforme à la norme NMB-003 du Canada.

Hinweise zur Auswahl des richtigen Schwenkarms für Ihren Monitor

Dieser Monitor ist für Bildschirmarbeitsplätze vorgesehen. Wenn nicht der zum Standardzubehör gehörige Schwenkarm verwendet wird, muss statt dessen ein geeigneter anderer Schwenkarm installiert werden. Bei der Auswahl des Schwenkarms sind die nachstehenden Hinweise zu berücksichtigen:

Der Standfuß muß den nachfolgenden Anforderungen entsprechen:

- a) Der Standfuß muß eine ausreichende mechanische Stabilität zur Aufnahme des Gewichtes vom Bildschirmgerät und des spezifizierten Zubehörs besitzen. Das Gewicht des Bildschirmgerätes und des Zubehörs sind in der zugehörigen Bedienungsanleitung angegeben.
- b) Die Befestigung des Standfusses muß derart erfolgen, daß die oberste Zeile der Bildschirmanzeige nicht höher als die Augenhöhe eines Benutzers in sitzender Position ist.
- c) Im Fall eines stehenden Benutzers muß die Befestigung des Bildschirmgerätes derart erfolgen, daß die Höhe der Bildschirmmitte über dem Boden zwischen 135 – 150 cm beträgt.
- d) Der Standfuß muß die Möglichkeit zur Neigung des Bildschirmgerätes besitzen (max. vorwärts: 5°, min. nach hinten $\geq 5^\circ$).
- e) Der Standfuß muß die Möglichkeit zur Drehung des Bildschirmgerätes besitzen (max. $\pm 180^\circ$). Der maximale Kraftaufwand dafür muß weniger als 100 N betragen.
- f) Der Standfuß muß in der Stellung verharren, in die er manuell bewegt wurde.
- g) Der Glanzgrad des Standfusses muß weniger als 20 Glanzeinheiten betragen (seidenmatt).
- h) Der Standfuß mit Bildschirmgerät muß bei einer Neigung von bis zu 10° aus der normalen aufrechten Position kippsicher sein.

Hinweis zur Ergonomie:

Dieser Monitor erfüllt die Anforderungen an die Ergonomie nach EK1-ITB2000 mit dem Videosignal, 1280 × 1024, Digital Eingang und mindestens 60,0 Hz Bildwiederholfrequenz, non interlaced. Weiterhin wird aus ergonomischen Gründen empfohlen, die Grundfarbe Blau nicht auf dunklem Untergrund zu verwenden (schlechte Erkennbarkeit, Augenbelastung bei zu geringem Zeichenkontrast.)

Übermäßiger Schalldruck von Ohrhörern bzw. Kopfhörern kann einen Hörverlust bewirken. Eine Einstellung des Equalizers auf Maximalwerte erhöht die Ausgangsspannung am Ohrhörer- bzw. Kopfhörerausgang und damit auch den Schalldruckpegel.

„Maschinenlärminformations-Verordnung 3. GPSGV:

Der höchste Schalldruckpegel beträgt 70 dB(A) oder weniger gemäss EN ISO 7779“

[Begrenzung des maximalen Schalldruckpegels am Ohr]

Bildschirmgeräte: Größte Ausgangsspannung 150 mV

LIMITED WARRANTY

EIZO Corporation (hereinafter referred to as “**EIZO**”) and distributors authorized by EIZO (hereinafter referred to as the “**Distributors**”) warrant, subject to and in accordance with the terms of this limited warranty (hereinafter referred to as the “**Warranty**”), to the original purchaser (hereinafter referred to as the “**Original Purchaser**”) who purchased the product specified in this document (hereinafter referred to as the “**Product**”) from EIZO or Distributors, that EIZO and Distributors shall, at their sole discretion, either repair or replace the Product at no charge if the Original Purchaser becomes aware within the Warranty Period (defined below) that the Product malfunctions or is damaged in the course of normal use of the Product in accordance with the description in the instruction manual attached to the Product (hereinafter referred to as the “**User’s Manual**”).

The period of this Warranty is limited to (i) five (5) years from the date of purchase of the Product; or, limited to the expiration of (ii) 30,000 hours of its use of the Product (hereinafter referred to as the “**Warranty Period**”). EIZO and Distributors shall bear no liability or obligation with regard to the Product in relation to the Original Purchaser or any third parties other than as provided under this Warranty.

EIZO and Distributors will cease to hold or store any parts of the Product upon expiration of seven (7) years after the production of such parts is discontinued. In repairing the monitor, EIZO and Distributors will use renewal parts which comply with our QC standards.

The Warranty is valid only in the countries or territories where the Distributors are located. The Warranty does not restrict any legal rights of the Original Purchaser.

Notwithstanding any other provision of this Warranty, EIZO and Distributors shall have no obligation under this Warranty whatsoever in any of the cases as set forth below:

- (a) Any defect of the Product caused by freight damage, modification, alteration, abuse, misuse, accident, incorrect installation, disaster, faulty maintenance and/or improper repair by third party other than EIZO and Distributors;
- (b) Any incompatibility of the Product due to possible technical innovations and/or regulations;
- (c) Any deterioration of the sensor;
- (d) Any deterioration of display performance caused by the deterioration of expendable parts such as the LCD panel and/or backlight, etc. (e.g. changes in brightness, changes in brightness uniformity, changes in color, changes in color uniformity, defects in pixels including burnt pixels, etc.);
- (e) Any defect of the Product caused by external equipment;
- (f) Any defect of the Product on which the original serial number has been altered or removed;
- (g) Any normal deterioration of the product, particularly that of consumables, accessories, and/or attachments (e.g. buttons, rotating parts, cables, User’s Manual, etc.); and
- (h) Any deformation, discoloration, and/or warp of the exterior of the product including that of the surface of the LCD panel.

To obtain service under the Warranty, the Original Purchaser must deliver the Product, freight prepaid, in its original package or other adequate package affording an equal degree of protection, assuming the risk of damage and/or loss in transit, to the local Distributor. The Original Purchaser must present proof of purchase of the Product and the date of such purchase when requesting services under the Warranty.

The Warranty Period for any replaced and/or repaired product under this Warranty shall expire at the end of the original Warranty Period.

EIZO OR DISTRIBUTORS ARE NOT RESPONSIBLE FOR ANY DAMAGE TO, OR LOSS OF, DATA OR OTHER INFORMATION STORED IN ANY MEDIA OR ANY PART OF ANY PRODUCT RETURNED TO EIZO OR DISTRIBUTORS FOR REPAIR.

EIZO AND DISTRIBUTORS MAKE NO FURTHER WARRANTIES, EXPRESSED OR IMPLIED, WITH RESPECT TO THE PRODUCT AND ITS QUALITY, PERFORMANCE, MERCHANTABILITY OR FITNESS FOR ANY PARTICULAR USE. IN NO EVENT SHALL EIZO OR DISTRIBUTORS BE LIABLE FOR ANY INCIDENTAL, INDIRECT, SPECIAL, CONSEQUENTIAL OR OTHER DAMAGE WHATSOEVER (INCLUDING, WITHOUT LIMITATION, DAMAGES FOR LOSS OF PROFIT, BUSINESS INTERRUPTION, LOSS OF BUSINESS INFORMATION, OR ANY OTHER PECUNIARY LOSS) ARISING OUT OF THE USE OR INABILITY TO USE THE PRODUCT OR IN ANY CONNECTION WITH THE PRODUCT, WHETHER BASED ON CONTRACT, TORT, NEGLIGENCE, STRICT LIABILITY OR OTHERWISE, EVEN IF EIZO OR DISTRIBUTORS HAVE BEEN ADVISED OF THE POSSIBILITY OF SUCH DAMAGES. THIS EXCLUSION ALSO INCLUDES ANY LIABILITY WHICH MAY ARISE OUT OF THIRD PARTY CLAIMS AGAINST THE ORIGINAL PURCHASER. THE ESSENCE OF THIS PROVISION IS TO LIMIT THE POTENTIAL LIABILITY OF EIZO AND DISTRIBUTORS ARISING OUT OF THIS LIMITED WARRANTY AND/OR SALES.

BEGRENZTE GARANTIE

EIZO Corporation (im Weiteren als „**EIZO**“ bezeichnet) und die Vertragsimporteure von EIZO (im Weiteren als „**Vertrieb(e)**“ bezeichnet) garantieren dem ursprünglichen Käufer (im Weiteren als „**Erstkäufer**“ bezeichnet), der das in diesem Dokument vorgegebene Produkt (im Weiteren als „**Produkt**“ bezeichnet) von EIZO oder einem Vertrieb erworben hat, gemäß den Bedingungen dieser beschränkten Garantie (im Weiteren als „**Garantie**“ bezeichnet), dass EIZO und der Vertrieb nach eigenem Ermessen das Produkt entweder kostenlos reparieren oder austauschen, falls der Erstkäufer innerhalb der Garantiefrist (weiter unten festgelegt) eine Fehlfunktion bzw. Beschädigung des Produkts feststellt, die während des normalen Gebrauchs des Produkts gemäß den Anweisungen des zum Lieferumfang des Produkts gehörenden Benutzerhandbuchs (im Weiteren als „**Benutzerhandbuch**“ bezeichnet) aufgetreten ist.

Die Dauer der Garantieleistung beträgt (i) fünf (5) Jahre ab dem Erstverkaufsdatum des Produkts oder (ii) 30.000 Betriebsstunden des Produkts (im Weiteren als „**Garantiefrist**“ bezeichnet). EIZO und die Vertriebe übernehmen über den Rahmen dieser Garantie hinaus hinsichtlich des Produkts keinerlei Haftung oder Verpflichtung dem Erstkäufer oder Dritten gegenüber.

EIZO und die Vertriebe verpflichten sich, Ersatzteile für das Produkt über einen Zeitraum von sieben (7) Jahren nach Einstellung der Produktion der Ersatzteile zu lagern bzw. anzubieten. EIZO und seine Vertriebspartner verpflichten sich, bei einer etwaigen Reparatur des Monitors ausschließlich Produkte gemäß den EIZO-Qualitätssicherungsstandards zu verwenden.

Diese Garantie gilt nur in Ländern oder Gebieten, in denen sich Vertriebe befinden. Die gesetzlichen Gewährleistungsrechte des Erstkäufers gegenüber dem Verkäufer werden durch diese Garantie nicht berührt.

EIZO und die Vertriebe besitzen im Rahmen dieser Garantie keinerlei Verpflichtung in den folgenden Fällen:

- (a) Produktdefekte, die auf Frachtschäden, Modifikation, Nachgestaltung, Missbrauch, Fehlbedienung, Unfälle, unsachgemäße Installation, Naturkatastrophen, fehlerhafte Wartung und/oder unsachgemäße Reparatur durch eine andere Partei als EIZO und die Vertriebe zurückzuführen sind.
- (b) Eine Inkompatibilität des Produkts aufgrund von technischen Neuerungen und/oder neuen Bestimmungen, die nach dem Kauf in Kraft treten.
- (c) Jegliche Verschlechterung des Sensors.
- (d) Jegliche Verschlechterung der Bildschirmleistung, die durch Verschleißteile wie das LCD-Panel und/oder die Hintergrundbeleuchtung usw. hervorgerufen werden (z.B. Veränderungen von Helligkeit oder Helligkeitsverteilung, Veränderungen von Farbe oder Farbverteilung, Pixeldefekte einschließlich von durchgebrannten Pixeln usw.).
- (e) Produktdefekte, die durch externe Geräte verursacht werden.
- (f) Jeglicher Defekt eines Produkts, dessen ursprüngliche Seriennummer geändert oder entfernt wurde.
- (g) Normale Abnutzung des Produkts, insbesondere von Verbrauchsteilen, Zubehörteilen und/oder Beilagen (z.B. Tasten, drehbare Teile, Kabel, Benutzerhandbuch usw.); sowie
- (h) Verformungen, Verfärbungen und/oder Verziehungen am Produktäußeren, einschließlich der Oberfläche des LCD-Panels.

Bei Inanspruchnahme der Garantieleistung ist der Erstkäufer verpflichtet, das Produkt auf eigene Kosten und in der Originalverpackung bzw. einer anderen geeigneten Verpackung, die einen gleichwertigen Schutz gegen Transportschäden bietet, an den örtlichen Vertrieb zu übersenden, wobei der Erstkäufer das Transportrisiko gegenüber Schäden und/oder Verlust trägt. Zum Zeitpunkt der Inanspruchnahme der Garantieleistung muss der Erstkäufer einen Verkaufsbeleg vorweisen, auf dem das Kaufdatum angegeben ist.

Die Garantiefrist für ein im Rahmen dieser Garantie ausgetauschtes und/oder repariertes Produkt erlischt nach Ablauf der ursprünglichen Garantiefrist.

EIZO ODER DIE EIZO-VERTRAGSIMPORTEURE HAFTEN NICHT FÜR ZERSTÖRTE DATENBESTÄNDE ODER DIE KOSTEN DER WIEDERBESCHAFFUNG DIESER DATENBESTÄNDE AUF JEDLICHEN DATENTRÄGERN ODER TEILEN DES PRODUKTS, DIE IM RAHMEN DER GARANTIE BEI EIZO ODER DEN EIZO-VERTRAGSIMPORTEUREN ZUR REPARATUR EINGEREICHT WURDEN.

EIZO UND DIE EIZO-VERTRAGSIMPORTEURE GEBEN WEDER EXPLIZITE NOCH IMPLIZITE GARANTIEEN IN BEZUG AUF DIESES PRODUKT UND SEINE QUALITÄT, LEISTUNG, VERKÄUFLICHKEIT ODER EIGNUNG FÜR EINEN BESTIMMTEN ZWECK. AUF KEINEN FALL SIND EIZO ODER DIE EIZO-VERTRAGSIMPORTEURE VERANTWORTLICH FÜR JEDLICHE ZUFÄLLIGE, INDIREKTE, SPEZIELLE, FOLGE- ODER ANDERE SCHÄDEN JEDLICHER ART (EINSCHLIESSLICH OHNE JEDE BEGRENZUNG SCHÄDEN BEZÜGLICH PROFITVERLUST, GESCHÄFTSUNTERBRECHUNG, VERLUST VON GESCHÄFTSINFORMATION ODER JEDLICHE ANDEREN FINANZIELLEN EINBUSSEN), DIE DURCH DIE VERWENDUNG DES PRODUKTES ODER DIE UNFÄHIGKEIT ZUR VERWENDUNG DES PRODUKTES ODER IN JEDLICHER BEZIEHUNG MIT DEM PRODUKT, SEI ES BASIEREND AUF VERTRAG, SCHADENSERSATZ, NACHLAESSIGKEIT, STRIKTE HAFTPFLICHT ODER ANDEREN FORDERUNGEN ENTSTEHEN, AUCH WENN EIZO UND DIE EIZO-VERTRAGSIMPORTEURE IM VORAUS ÜBER DIE MÖGLICHKEIT SOLCHER SCHÄDEN INFORMIERT WURDEN. DIESER AUSSCHLUSS ENTHÄLT AUCH JEDE HAFTPFLICHT, DIE AUS FORDERUNGEN DRITTER GEGEN DEN ERSTKÄUFER ENTSTEHEN KANN. ZWECK DIESER KLAUSEL IST ES, DIE HAFTUNG VON EIZO UND DEN VERTRIEBEN GEGENÜBER FORDERUNGEN ZU BEGRENZEN, DIE AUS DIESER BESCHRÄNKTEN GARANTIE UND/ODER DEM VERKAUF ENTSTEHEN KÖNNEN.

GARANTIE LIMITÉE

EIZO Corporation (ci-après dénommé « **EIZO** ») et les distributeurs autorisés par EIZO (ci-après dénommés « **Distributeurs** »), sous réserve et conformément aux termes de cette garantie limitée (ci-après dénommée « **Garantie** »), garantissent à l'acheteur initial (ci-après dénommé « **Acheteur initial** ») du produit spécifié dans la présente (ci-après dénommé « **Produit** ») acheté auprès d'EIZO ou de Distributeurs agréés EIZO, que EIZO et ses Distributeurs auront pour option de réparer ou remplacer gratuitement le Produit si l'Acheteur initial constate, pendant la Période de garantie (définie ci-dessous), qu'il y a un dysfonctionnement ou que le Produit a subi un dommage dans le cadre d'une utilisation normale du Produit conformément à la description du mode d'emploi qui accompagne le Produit (ci-après dénommé « **Manuel d'utilisation** »).

La période de cette Garantie est limitée à (i) cinq (5) ans à partir de la date d'achat du Produit ; ou, limitée jusqu'à l'expiration de (ii) 30 000 heures d'utilisation du Produit (ci-après dénommée « **Période de Garantie** »). EIZO et ses Distributeurs déclinent toute responsabilité ou obligation concernant ce Produit face à l'Acheteur initial ou à toute autre personne à l'exception de celles stipulées dans la présente Garantie.

EIZO et ses Distributeurs cesseront de tenir ou conserver en stock toute pièce de ce Produit après l'expiration de la période de sept (7) ans suivant l'arrêt de la production de telles pièces. Pour réparer le moniteur, EIZO et ses distributeurs utiliseront des pièces de rechange conformes à nos normes de contrôle qualité.

La Garantie est valable uniquement dans les pays ou les territoires où se trouvent les Distributeurs. La Garantie ne limite aucun des droits reconnus par la loi à l'Acheteur initial.

Nonobstant toute autre clause de cette Garantie, EIZO et ses Distributeurs n'auront d'obligation dans le cadre de cette Garantie pour aucun des cas énumérés ci-dessous :

- (a) Tout défaut du Produit résultant de dommages occasionnés lors du transport, d'une modification, d'une altération, d'un abus, d'une mauvaise utilisation, d'un accident, d'une installation incorrecte, d'un désastre, d'un entretien et/ou d'une réparation incorrects effectués par une personne autre que EIZO ou ses Distributeurs ;
- (b) Toute incompatibilité du Produit résultant d'améliorations techniques et/ou réglementations possibles ;
- (c) Toute détérioration du capteur ;
- (d) Toute détérioration des performances d'affichage causée par la détérioration des éléments consommables tels que le panneau LCD et/ou le rétroéclairage, etc. (par exemple des changements de luminosité, des changements de l'uniformité de la luminosité, des modifications de couleur, des changements de l'uniformité des couleurs, des défauts de pixels y compris des pixels brûlés, etc.);
- (e) Tout défaut du Produit causé par un appareil externe ;
- (f) Tout défaut d'un Produit sur lequel le numéro de série original a été altéré ou supprimé ;
- (g) Toute détérioration normale du Produit, particulièrement celle des consommables, des accessoires et/ou des pièces reliées au Produit (touches, éléments pivotants, câbles, Manuel d'utilisation etc.), et
- (h) Toute déformation, décoloration, et/ou gondolage de l'extérieur du Produit, y compris celle de la surface du panneau LCD.

Pour bénéficier d'un service dans le cadre de cette Garantie, l'Acheteur initial doit renvoyer le Produit port payé, dans son emballage d'origine ou tout autre emballage approprié offrant un degré de protection équivalent, au Distributeur local, et assumera la responsabilité des dommages et/ou perte possibles lors du transport. L'Acheteur initial doit présenter une preuve d'achat du Produit comprenant sa date d'achat pour bénéficier de ce service dans le cadre de la Garantie.

La Période de garantie pour tout Produit remplacé et/ou réparé dans le cadre de cette Garantie expirera à la fin de la Période de garantie initiale.

EIZO OU SES DISTRIBUTEURS NE SAURAIENT ÊTRE TENUS RESPONSABLES DES DOMMAGES OU PERTES DE DONNÉES OU D'AUTRES INFORMATIONS STOCKÉES DANS UN MÉDIA QUELCONQUE OU UNE AUTRE PARTIE DU PRODUIT RENVOYÉ À EIZO OU AUX DISTRIBUTEURS POUR RÉPARATION.

AUCUNE AUTRE GARANTIE, EXPLICITE OU TACITE, N'EST OFFERTE PAR EIZO ET SES DISTRIBUTEURS CONCERNANT LE PRODUIT ET SES QUALITÉS, PERFORMANCES, QUALITÉ MARCHANDE OU ADAPTATION À UN USAGE PARTICULIER. EN AUCUN CAS, EIZO OU SES DISTRIBUTEURS NE SERONT RESPONSABLES DES DOMMAGES FORTUITS, INDIRECTS, SPÉCIAUX, INDUITS, OU DE TOUT AUTRE DOMMAGE QUEL QU'IL SOIT (Y COMPRIS, SANS LIMITATION, LES DOMMAGES RÉSULTANT D'UNE PERTE DE PROFIT, D'UNE INTERRUPTION D'ACTIVITÉS, D'UNE PERTE DE DONNÉES COMMERCIALES, OU DE TOUT AUTRE MANQUE À GAGNER) RÉSULTANT DE L'UTILISATION OU DE L'INCAPACITÉ D'UTILISER LE PRODUIT OU AYANT UN RAPPORT QUELCONQUE AVEC LE PRODUIT, QUE CE SOIT SUR LA BASE D'UN CONTRAT, D'UN TORT, D'UNE NÉGLIGENCE, D'UNE RESPONSABILITÉ STRICTE OU AUTRE, MÊME SI EIZO OU SES DISTRIBUTEURS ONT ÉTÉ AVERTIS DE LA POSSIBILITÉ DE TELS DOMMAGES. CETTE LIMITATION INCLUT AUSSI TOUTE RESPONSABILITÉ QUI POURRAIT ÊTRE SOULEVÉE LORS DES RÉCLAMATIONS D'UN TIERS CONTRE L'ACHETEUR INITIAL. L'ESSENCE DE CETTE CLAUSE EST DE LIMITER LA RESPONSABILITÉ POTENTIELLE DE EIZO ET DE SES DISTRIBUTEURS RÉSULTANT DE CETTE GARANTIE LIMITÉE ET/OU DES VENTES.

GARANTÍA LIMITADA

EIZO Corporation (en lo sucesivo “**EIZO**”) y sus distribuidores autorizados (en lo sucesivo los “**Distribuidores**”), con arreglo y de conformidad con los términos de esta garantía limitada (en lo sucesivo la “**Garantía**”), garantizan al comprador original (en lo sucesivo el “**Comprador original**”) que compró el producto especificado en este documento (en lo sucesivo el “**Producto**”) a EIZO o a sus Distribuidores, que EIZO y sus Distribuidores, a su propio criterio, repararán o sustituirán el Producto de forma gratuita si el Comprador original detecta dentro del periodo de la Garantía (indicado posteriormente) que el Producto no funciona correctamente o que se ha averiado durante el uso normal del mismo de acuerdo con las indicaciones del manual de instrucciones suministrado con el Producto (en lo sucesivo el “**Manual del usuario**”).

El período de validez de esta Garantía está limitado a (i) cinco (5) años a partir de la fecha de compra del Producto o (ii) a 30.000 horas de uso del Producto (en adelante designado como el “**Periodo de Garantía**”). EIZO y sus Distribuidores no tendrán ninguna responsabilidad ni obligación con respecto al Producto para con el Comprador original ni para con terceros que no sean las estipuladas en la presente Garantía.

EIZO y sus Distribuidores no estarán obligados a suministrar cualquier recambio del Producto una vez pasados siete (7) años desde que se deje de fabricar el mismo. Para la reparación del monitor, EIZO y los distribuidores utilizarán repuestos que cumplan con nuestros estándares de control de calidad.

La Garantía es válida sólo en los países y territorios donde están ubicados los Distribuidores. La Garantía no restringe ningún derecho legal del Comprador original.

A pesar de las estipulaciones de esta Garantía, EIZO y sus Distribuidores no tendrán obligación alguna bajo esta Garantía en ninguno de los casos expuestos a continuación:

- (a) Cualquier defecto del Producto causado por daños en el transporte, modificación, alteración, abuso, uso incorrecto, accidente, instalación incorrecta, desastre, mantenimiento incorrecto y/o reparación indebida realizada por un tercero que no sea EIZO o sus Distribuidores.
- (b) Cualquier incompatibilidad del Producto debida a posibles innovaciones técnicas y/o reglamentaciones.
- (c) Cualquier deterioro del sensor.
- (d) Cualquier deterioro en el rendimiento de la visualización causado por fallos en las piezas consumibles como el panel LCD y/o la "Backlight", etc. (p. ej. cambios de brillo, cambios de uniformidad del brillo, cambios de color, cambios de uniformidad del color, defectos de píxeles, incluyendo píxeles muertos, etc.).
- (e) Cualquier defecto del Producto causado por un equipo externo.
- (f) Cualquier defecto del Producto en el que haya sido alterado o borrado el número de serie original.
- (g) Cualquier deterioro normal del Producto, y en particular de las piezas consumibles, accesorios y demás (p. ej. botones, piezas giratorias, cables, Manual del usuario, etc.).
- (h) Cualquier deformación, decoloración y/o alabeo del exterior del Producto incluida la superficie del panel LCD.

Para obtener servicio en los términos de esta Garantía, el Producto deberá ser enviado por el Comprador original, a su Distribuidor local, con el transporte previamente pagado, en el embalaje original u otro embalaje adecuado que ofrezca el mismo grado de protección, asumiendo el riesgo de daños y/o pérdida del Producto durante el transporte. El Comprador original deberá presentar un comprobante de compra del Producto en el que se refleje la fecha de compra del mismo cuando lo solicite el servicio de Garantía.

El Periodo de garantía para cualquier Producto reemplazado y/o reparado en los términos de esta Garantía expirará al vencer el Periodo de garantía original.

EIZO O LOS DISTRIBUIDORES AUTORIZADOS DE EIZO NO SE RESPONSABILIZAN DE NINGÚN DAÑO O PÉRDIDA QUE PUEDAN SUFRIR LOS DATOS U OTRA INFORMACIÓN ALMACENADA EN CUALQUIER MEDIO O CUALQUIER PARTE DE CUALQUIER PRODUCTO DEVUELTO A EIZO O A LOS DISTRIBUIDORES DE EIZO PARA SU REPARACIÓN.

EIZO Y LOS DISTRIBUIDORES AUTORIZADOS DE EIZO NO OFRECEN NINGUNA OTRA GARANTÍA, IMPLÍCITA NI EXPLÍCITA, CON RESPECTO AL PRODUCTO Y A SU CALIDAD, RENDIMIENTO, COMERCIABILIDAD E IDONEIDAD PARA CUALQUIER USO EN PARTICULAR. EN NINGÚN CASO SERÁN EIZO O LOS DISTRIBUIDORES AUTORIZADOS DE EIZO RESPONSABLES DE NINGÚN DAÑO EMERGENTE, INDIRECTO, ESPECIAL, INHERENTE O CUALQUIERA QUE SEA (INCLUYENDO, SIN LIMITACIÓN, DAÑOS POR LUCRO CESANTE, INTERRUPCIÓN DE LA ACTIVIDAD COMERCIAL, PÉRDIDA DE INFORMACIÓN COMERCIAL O CUALQUIER OTRA PÉRDIDA PECUNIARIA) QUE SE DERIVE DEL USO O IMPOSIBILIDAD DE USO DEL PRODUCTO O EN RELACIÓN CON EL PRODUCTO, YA SEA BASADO EN CONTRATO, POR AGRAVIO, NEGLIGENCIA, ESTRICTA RESPONSABILIDAD O CUALQUIERA QUE SEA, AUN CUANDO SE HAYA ADVERTIDO A EIZO O A LOS DISTRIBUIDORES DE EIZO DE LA POSIBILIDAD DE TALES DAÑOS. ESTA EXCLUSIÓN TAMBIÉN ABARCA CUALQUIER RESPONSABILIDAD QUE PUEDA DERIVARSE DE RECLAMACIONES HECHAS POR UN TERCERO CONTRA EL COMPRADOR ORIGINAL. LA ESENCIA DE ESTA ESTIPULACIÓN ES LIMITAR LA RESPONSABILIDAD POTENCIAL DE EIZO Y LOS DISTRIBUIDORES QUE PUDIERA DERIVARSE DE ESTA GARANTÍA LIMITADA Y/O VENTAS.

GARANZIA LIMITATA

EIZO Corporation (a cui si farà riferimento da qui in poi con “**EIZO**”) ed i Distributori autorizzati da EIZO (a cui si farà riferimento da qui in poi con “**Distributori**”) garantiscono, secondo i termini di questa garanzia limitata (a cui si farà riferimento da qui in poi con “**Garanzia**”) all'acquirente originale (a cui si farà riferimento da qui in poi con “**Acquirente originale**”) che ha acquistato il prodotto specificato in questo documento (a cui si farà riferimento da qui in poi con “**Prodotto**”) da EIZO o dai suoi Distributori, che EIZO e i distributori, a loro discrezione, ripareranno o sostituiranno il Prodotto senza addebito se l'Acquirente originale trova, entro il periodo della Garanzia (definito sotto), che il Prodotto malfunziona e si è danneggiato nel corso del suo normale utilizzo osservando le indicazioni del manuale di istruzioni allegato al Prodotto (a cui si farà riferimento da qui in poi con “**Manuale utente**”).

La presente Garanzia è limitata a (i) cinque (5) anni a partire dalla data d'acquisto del Prodotto o (ii) allo scadere di 30.000 ore d'utilizzo del Prodotto (a cui si farà riferimento da qui in poi con “**Periodo di Garanzia**”). EIZO e i suoi Distributori non si assumono alcuna responsabilità e non hanno alcun obbligo riguardo al Prodotto verso l'Acquirente originale o terzi diversi da quelli relativi a questa Garanzia.

EIZO e i suoi Distributori cesseranno di tenere o di conservare qualsiasi ricambio del Prodotto allo scadere di sette (7) anni dopo che la produzione di tali ricambi è stata terminata. Per la riparazione del monitor, EIZO e i Distributori utilizzeranno parti di ricambio conformi ai nostri standard di controllo della qualità.

La Garanzia è valida soltanto nei paesi dove ci sono i Distributori EIZO. La Garanzia non limita alcun diritto legale dell'Acquirente originale.

Indipendentemente da qualsiasi altra condizione di questa Garanzia, EIZO e i suoi Distributori non avranno alcun obbligo derivante da questa Garanzia in ognuno dei casi elencati di seguito:

- (a) Qualsiasi difetto del Prodotto causato da danni di trasporto, modifiche, alterazioni, abusi, usi impropri, incidenti, installazione errata, calamità, manutenzione errata e/o riparazioni improprie eseguite da terze parti che non siano EIZO o i suoi Distributori.
- (b) Qualsiasi incompatibilità del Prodotto dovuta a possibili innovazioni tecniche e/o normative.
- (c) Qualsiasi deterioramento del sensore.
- (d) Qualsiasi deterioramento delle prestazioni dello schermo causato dal deterioramento delle parti consumabili, come il pannello LCD e/o la retroilluminazione, ecc. (per esempio: i cambiamenti di luminosità, cambiamenti di uniformità della luminosità, i cambiamenti di colore, i cambiamenti di uniformità del colore, i difetti dei pixel, inclusi i pixel bruciati, ecc.).
- (e) Qualsiasi difetto del Prodotto causato da apparecchiature esterne.
- (f) Qualsiasi difetto del Prodotto in cui il numero di serie originale sia stato alterato o rimosso.
- (g) Qualsiasi normale deterioramento del Prodotto, in particolar modo nelle sue parti di consumo, accessori, e/o attacchi (per esempio: tasti, parti rotanti, cavi, Manuale dell'utente, ecc.).
- (h) Qualsiasi tipo di deformazione, scolorimento, e/o di involucro esterno del Prodotto inclusa la superficie del pannello LCD.

Per ricevere assistenza tecnica con questa Garanzia, l'Acquirente originale deve inviare il Prodotto, con trasporto pre-pagato, nella sua confezione originale o altra confezione adeguata che fornisce un livello analogo di protezione, assumendosi il rischio di danni e/o perdita in transito, al Distributore locale. L'Acquirente originale deve presentare la prova di acquisto che stabilisce la data di acquisto del Prodotto quando richiede servizio sotto Garanzia.

Il Periodo di garanzia per qualsiasi Prodotto sostituito e/o riparato sotto questa Garanzia scade alla fine del Periodo di garanzia originale.

EIZO O I SUOI DISTRIBUTORI NON SONO RESPONSABILI PER QUALSIASI DANNO O PERDITA DI DATI O ALTRE INFORMAZIONI MEMORIZZATI SU QUALSIASI SUPPORTO O QUALSIASI PARTE DI QUALSIASI PRODOTTO INVIATO A EIZO O I SUOI DISTRIBUTORI PER RIPARAZIONI.

EIZO E I SUOI DISTRIBUTORI NON OFFRONO ALCUNA GARANZIA ADDIZIONALE, IMPLICITA O ESPLICITA, RIGUARDO IL PRODOTTO E LA SUA QUALITÀ, PRESTAZIONI, VENDIBILITÀ O APPROPRIATEZZA PER QUALSIASI USO PARTICOLARE. IN NESSUN CASO EIZO O I DISTRIBUTORI EIZO AUTORIZZATI SARANNO RESPONSABILI PER QUALSIASI DANNO ACCIDENTALE, INDIRECTO, SPECIALE, CONSEGUENTE O DI QUALSIASI ALTRA NATURA (INCLUSI, SENZA LIMITI, DANNI PER PERDITA DI PROFITTI, INTERRUZIONE DELLE ATTIVITÀ, PERDITA DI INFORMAZIONI D'AFFARI O QUALSIASI ALTRA PERDITA PECUNIARIA) DERIVANTI DALL'USO O DALL'IMPOSSIBILITÀ DI USARE IL PRODOTTO O IN QUALSIASI RELAZIONE AL PRODOTTO, SIA SU BASE DI CONTRATTO, TORTO, NEGLIGENZA, STRETTA RESPONSABILITÀ O ALTRIMENTI, ANCHE SE EIZO O I DISTRIBUTORI EIZO AUTORIZZATI SONO STATI AVVERTITI DELLA POSSIBILITÀ DI TALI DANNI. QUESTA ESCLUSIONE INCLUE ANCHE QUALSIASI RESPONSABILITÀ CHE POSSA INSORGERE DA RECLAMI DI TERZI CONTRO L'ACQUIRENTE ORIGINALE. L'ESSENZA DI QUESTO PROVVEDIMENTO È LIMITARE LA RESPONSABILITÀ POTENZIALE DI EIZO E DEI DISTRIBUTORI DERIVANTE DA QUESTA GARANZIA LIMITATA E/O DALLE VENDITE.

BEGRÄNSAD GARANTI

EIZO Corporation (nedan kallat "EIZO") och EIZOs auktoriserade distributörer (nedan kallade "Distributörer") garanterar i enlighet med villkoren i denna begränsade garanti (nedan kallad "Garantin") den ursprunglige köparen (nedan kallad den "Ursprunglige köparen") som köpte den i dokumentet specificerade produkten (nedan kallad "Produkten") från EIZO eller Distributörer, att EIZO eller Distributörer enligt eget gottfinnande kostnadsfritt antingen reparera eller byta ut den defekta Produkten om den Ursprunglige köparen inom Garantiperioden (definieras nedan) upptäcker att Produkten fungerar felaktigt eller skadas under normal användning av Produkten i enlighet med beskrivningen i bruksanvisningen (nedan kallad "Bruksanvisning").

Giltighetsperioden för denna garanti är begränsad till (i) fem (5) år från datumet för Produktens inköp eller, om detta inträffar tidigare, begränsat till utlöpanget av (ii) 30 000 timmars användning av Produkten (häri kallad "Garantiperioden"). EIZO och Distributörer ska inte under några villkor ha något annat ansvar än vad som anges i denna garanti gällande Produkten i relation till den Ursprunglige köparen eller tredje part.

EIZO och Distributörer kommer att upphöra med lagerhållning av Produktens delar efter sju (7) år efter att produktionen av dessa delar upphört. Nät skärmen repareras använder EIZO och distributörer reservdelar som uppfyller våra kvalitetsstandarder.

Garantin är endast giltig i de länder där det finns Distributörer. Garantin begränsar inte några av den Ursprunglige köparens lagstadgade rättigheter.

Oavsett andra villkor i denna garanti ska inte EIZO Distributörer under några villkor ha något ansvar i något av de fall som beskrivs nedan:

- (a) När någon bristfällighet hos Produkten kan härledas till att ha uppstått vid frakt, modifiering, ändring, felaktigt handhavande, olycka, felaktig installation, katastrof, felaktigt underhåll och/eller felaktig reparation utförd av tredje part annan än EIZO och Distributörer.
- (b) Alla former av inkompatibilitet hos Produkten på grund av möjliga tekniska innovationer och/eller bestämmelser.
- (c) Alla försämringar av sensorn.
- (d) Alla försämringar av bildens prestanda beroende på förbrukningsdelar så som LCD-panel och/eller bakgrundsbelysning etc. (t.ex. ändringar i ljusstyrka, jämnhet i ljusstyrka, färg, färgjämnhet, defekta pixlar och/eller fast lysande pixlar etc.).
- (e) Alla defekter hos Produkten som orsakats av extern utrustning.
- (f) Alla defekter hos Produkten på vilken det ursprungliga serienumret har ändrats eller avlägsnats.
- (g) All normal försämring av Produkten, speciellt förbrukningsartiklar, tillbehör och/eller yttre delar (t.ex. knappar, roterande delar, kablar, Bruksanvisningen etc.).
- (h) Varje deformation, missfärgning och/eller skevhet av Produktens yttre inklusive ytan på LCD-panelen.

För att erhålla service under denna garanti måste den Ursprunglige köparen (med hänseende till risken för skada och/eller förlust under transport) leverera Produkten till närmaste Distributör med förebetald frakt, i dess ursprungliga förpackning eller annan fullgod förpackning som ger likvärdigt skydd. Den Ursprunglige köparen måste kunna visa inköpsbevis för Produkten som klargör Produktens inköpsdatum vid begäran av garantiservice.

Garantiperioden för alla utbytta och/eller reparerade produkter under denna garanti skall upphöra vid utgången av den ursprungliga Garantiperioden.

EIZO ELLER DISTRIBUTÖRER ÄR INTE ANSVARIGA FÖR NÅGON FORM AV SKADA ELLER FÖRLUST AV DATA ELLER ANNAN INFORMATION SOM HAR LAGRATS I NÅGON FORM AV MEDIA ELLER ANNAN DEL AV NÅGON PRODUKT SOM HAR RETURNERATS TILL EIZO ELLER DISTRIBUTÖRER FÖR REPARATION.

EIZO OCH DISTRIBUTÖRERNA GARANTERAR INGET, UTTRYCKLIGEN ELLER UNDERFÖRSTÅTT, VAD BETRÄFFAR PRODUKTEN OCH DESS KVALITET, PRESTANDA, SÄLJBARHET ELLER LÄMPLIGHET FÖR NÅGON FORM AV SPECIELL ANVÄNDNING. UNDER INGA OMSTÄNDIGHETER SKALL EIZO ELLER DISTRIBUTÖRERNA HÅLLAS ANSVARIGA FÖR NÅGRA SOM HELST UNDERORDNADE, INDIREKTA, SPECIELLA, DÄRAV FÖLJANDE ELLER ÖVRIGA SKADOR (INKLUSIVE, UTAN BEGRÄNSNING TILL, SKADOR FÖR FÖRLUST AV INKOMST, AVBRUTEN AFFÄRSRÖRELSE, FÖRLUST AV AFFÄRSINFORMATION ELLER ANNAN SÄRSKILD FÖRLUST) SOM UPPSTÅTT SOM ETT RESULTAT AV ANVÄNDNING ELLER OFÖRMÅGA ATT ANVÄNDA PRODUKTEN ELLER I NÅGON FORM AV ANSLUTNING TILL PRODUKTERNA, VARE SIG DETTA GRUNDAS PÅ KONTRAKT, ÅTALBAR HANDLING, FÖRSUMLIGHET, ANSVARSSKYLDIGHET ELLER ANNAT, ÄVEN OM EIZO ELLER DISTRIBUTÖRERNA HAR INFORMERATS BETRÄFFANDE MÖJLIGHET ATT SÅDANA SKADOR FÖRELIGGER. DETTA UNDANTAG OMFATTAR ÄVEN ALL FORM AV ANSVARSSKYLDIGHET SOM KAN UPPSTÅ GENOM EN TREDJE PARTS ANSPRÅK GENTEMOT DEN URSPRUNGLIGE KÖPAREN. GRUNDBESTÄNDSDELEN I BESTÄMMELEN ÄR ATT BEGRÄNSA DET EVENTUELLA ANSVARSTAGANDET FÖR EIZO OCH DISTRIBUTÖRERNA SOM KAN UPPSTÅ GENOM DENNA BEGRÄNSADE GARANTI OCH/ELLER FÖRSÄLJNING.

ΠΕΡΙΟΡΙΣΜΕΝΗ ΕΓΓΥΗΣΗ

Η EIZO Corporation (στο εξής «**EIZO**») και οι διανομείς που εξουσιοδοτεί η EIZO (στο εξής «**Διανομείς**») παρέχουν εγγύηση, υποκείμενη και σύμφωνα με τους όρους της παρούσας περιορισμένης εγγύησης (στο εξής «**Εγγύηση**»), στον αρχικό αγοραστή (στο εξής «**Αρχικός Αγοραστής**») ο οποίος αγόρασε το προϊόν που καθορίζεται στο παρόν έγγραφο (στο εξής «**Προϊόν**») από την EIZO ή τους Διανομείς, η οποία εξασφαλίζει ότι η EIZO και οι Διανομείς, σύμφωνα με τη διακριτή ευχέρειά τους, είτε θα επισκευάσουν είτε θα αντικαταστήσουν το Προϊόν χωρίς χρέωση εάν ο Αρχικός Αγοραστής αντιληφθεί εντός της Περιόδου Εγγύησης (ορίζεται κατωτέρω) ότι το Προϊόν δυσλειτουργεί ή έχει υποστεί βλάβη κατά τη διάρκεια κανονικής χρήσης του Προϊόντος σύμφωνα με την περιγραφή στο εγχειρίδιο χρήσης που συνοδεύει το Προϊόν (στο εξής «**Εγχειρίδιο Χρήστη**»).

Η περίοδος της παρούσας Εγγύησης είναι (i) πέντε (5) έτη από την ημερομηνία αγοράς του Προϊόντος, ή, στη λήξη των (ii) 30.000 ωρών χρήσης του Προϊόντος (στο εξής «**Περίοδος Εγγύησης**»). Η EIZO και οι Διανομείς δεν φέρουν καμία ευθύνη ή υποχρέωση όσον αφορά το Προϊόν σε σχέση με τον Αρχικό Αγοραστή ή οποιοδήποτε τρίτο μέρος, ούτε άλλη ευθύνη διαφορετική από αυτήν που παρέχεται στην παρούσα Εγγύηση.

Η EIZO και οι Διανομείς θα παύσουν να διατηρούν ή να αποθηκεύουν τυχόν εξαρτήματα του Προϊόντος κατόπιν της λήξης των επτά (7) ετών μετά τη διακοπή της παραγωγής τέτοιων εξαρτημάτων. Κατά την επισκευή της οθόνης, η EIZO και οι Διανομείς θα χρησιμοποιήσουν ανταλλακτικά επισκευής που συμμορφώνονται με τα πρότυπα μας για τη Διασφάλιση Ποιότητας.

Η Εγγύηση ισχύει μόνο σε χώρες ή περιοχές όπου βρίσκονται οι Διανομείς. Η Εγγύηση δεν περιορίζει οποιαδήποτε νόμιμα δικαιώματα του Αρχικού Αγοραστή.

Λαμβανομένης υπόψη κάθε διάταξης της παρούσας Εγγύησης, η EIZO και οι Διανομείς δεν θα έχουν καμία απολύτως υποχρέωση σύμφωνα με την παρούσα Εγγύηση σε οποιαδήποτε από τις περιπτώσεις που διατυπώνονται κατωτέρω:

- (α) Τυχόν ελάττωμα του Προϊόντος που προκαλείται από ζημιά κατά τη μεταφορά, τροποποίηση, αλλαγή, κατάχρηση, λανθασμένη χρήση, ατύχημα, λανθασμένη εγκατάσταση, καταστροφή, εσφαλμένη συντήρηση ή/και λανθασμένη επισκευή από τρίτο μέρος εκτός της EIZO και των Διανομέων,
- (β) Τυχόν ασυμβατότητα του Προϊόντος λόγω πιθανών τεχνικών καινοτομιών ή/και κανονισμών,
- (γ) Τυχόν επιδείνωση του αισθητήρα,
- (δ) Τυχόν επιδείνωση της απόδοσης οθόνης που προκαλείται από τη φθορά αναλώσιμων εξαρτημάτων όπως της οθόνης LCD ή/και του φωτός υποβάθρου, κτλ. (π.χ. αλλαγές στη φωτεινότητα, αλλαγές στην ομοιομορφία φωτεινότητας, αλλαγές στο χρώμα, αλλαγές στην ομοιομορφία χρώματος, ελαττώματα σε pixel περιλαμβανομένων των καμένων pixel, κτλ.),
- (ε) Τυχόν ελάττωμα του Προϊόντος που προκαλείται από εξωτερικό εξοπλισμό,
- (στ) Τυχόν ελάττωμα του Προϊόντος στο οποίο έχει τροποποιηθεί ή αφαιρεθεί ο γνήσιος αριθμός σειράς,
- (ζ) Τυχόν φυσιολογική φθορά του προϊόντος, ιδιαίτερα αυτής των αναλώσιμων, των αξεσουάρ ή/και των προσαρτημάτων (π.χ. κουμπιά, περιστρεφόμενα μέρη, καλώδια, Εγχειρίδιο Χρήστη, κτλ.), και
- (η) Τυχόν παραμόρφωση, αποχρωματισμό ή/και διαστρέβλωση του εξωτερικού μέρους του προϊόντος, περιλαμβανομένης της επιφάνειας της οθόνης LCD.

Ο Αρχικός Αγοραστής για να δικαιούται υπηρεσίες επισκευής σύμφωνα με την Εγγύηση, θα πρέπει να παραδώσει το Προϊόν, με πληρωμένα τα μεταφορικά έξοδα, στην αρχική του συσκευασία ή σε άλλη επαρκή συσκευασία με ισότιμο βαθμό προστασίας, αναλαμβάνοντας τον κίνδυνο βλάβης ή/και απώλειας κατά τη μεταφορά, στον τοπικό Διανομέα. Ο Αρχικός Αγοραστής όταν ζητά υπηρεσίες επισκευής σύμφωνα με την Εγγύηση, θα πρέπει να προσκομίζει την απόδειξη αγοράς του Προϊόντος και την ημερομηνία της αγοράς.

Η Περίοδος Εγγύησης για οποιοδήποτε αντικατεστημένο ή/και επισκευασμένο προϊόν σύμφωνα με την παρούσα Εγγύηση λήγει στο τέλος της αρχικής Περιόδου Εγγύησης.

Η EIZO Ή ΟΙ ΔΙΑΝΟΜΕΙΣ ΔΕΝ ΕΥΘΥΝΟΝΤΑΙ ΓΙΑ ΟΠΟΙΟΔΗΠΟΤΕ ΒΛΑΒΗ Ή ΑΠΩΛΕΙΑ ΔΕΔΟΜΕΝΩΝ Ή ΑΛΛΩΝ ΠΛΗΡΟΦΟΡΙΩΝ ΠΟΥ ΑΠΟΘΗΚΕΥΟΝΤΑΙ ΣΕ ΟΠΟΙΟΔΗΠΟΤΕ ΜΕΣΟ Ή ΟΠΟΙΟΔΗΠΟΤΕ ΑΛΛΟ ΜΕΡΟΣ ΣΕ ΟΠΟΙΟΔΗΠΟΤΕ ΠΡΟΪΟΝ ΠΟΥ ΕΠΙΣΤΡΕΦΕΤΑΙ ΣΤΗΝ EIZO Ή ΣΕ ΔΙΑΝΟΜΕΑ ΓΙΑ ΕΠΙΣΚΕΥΗ.

Η EIZO ΚΑΙ ΟΙ ΔΙΑΝΟΜΕΙΣ ΔΕΝ ΠΑΡΕΧΟΥΝ ΚΑΜΙΑ ΠΕΡΑΙΤΕΡΩ ΕΓΓΥΗΣΗ, ΡΗΤΗ Ή ΣΥΝΕΠΑΓΟΜΕΝΗ, ΟΣΟΝ ΑΦΟΡΑ ΤΟ ΠΡΟΪΟΝ ΚΑΙ ΤΗΝ ΠΟΙΟΤΗΤΑ, ΤΗΝ ΑΠΟΔΟΣΗ, ΤΗΝ ΕΜΠΟΡΕΥΣΙΜΟΤΗΤΑ Ή ΤΗΝ ΚΑΤΑΛΛΗΛΟΤΗΤΑ ΤΟΥ ΓΙΑ ΟΠΟΙΟΔΗΠΟΤΕ ΣΥΓΚΕΚΡΙΜΕΝΗ ΧΡΗΣΗ. ΣΕ ΚΑΜΙΑ ΠΕΡΙΠΤΩΣΗ Η EIZO Ή ΟΙ ΔΙΑΝΟΜΕΙΣ ΔΕΝ ΘΑ ΕΥΘΥΝΟΝΤΑΙ ΓΙΑ ΚΑΜΙΑ ΑΠΟΛΥΤΩΣ ΤΥΧΑΙΑ, ΕΜΜΕΣΗ, ΕΙΔΙΚΗ, ΣΥΝΕΠΑΓΟΜΕΝΗ Ή ΑΛΛΗ ΒΛΑΒΗ (ΠΕΡΙΛΑΜΒΑΝΟΜΕΝΩΝ, ΜΕΤΑΞΥ ΑΛΛΩΝ, ΒΛΑΒΩΝ Ή ΑΠΩΛΕΙΑΣ ΚΕΡΔΩΝ, ΔΙΑΚΟΠΗΣ ΕΠΙΧΕΙΡΗΜΑΤΙΚΩΝ ΔΡΑΣΤΗΡΙΟΤΗΤΩΝ, ΑΠΩΛΕΙΑΣ ΕΠΙΧΕΙΡΗΜΑΤΙΚΩΝ ΠΛΗΡΟΦΟΡΙΩΝ Ή ΤΥΧΟΝ ΑΛΛΗΣ ΧΡΗΜΑΤΙΚΗΣ ΑΠΩΛΕΙΑΣ) ΠΟΥ ΠΡΟΚΥΠΤΕΙ ΑΠΟ ΤΗ ΧΡΗΣΗ Ή ΤΗΝ ΑΝΙΚΑΝΟΤΗΤΑ ΧΡΗΣΗΣ ΤΟΥ ΠΡΟΪΟΝΤΟΣ Ή ΤΥΧΟΝ ΑΛΛΗΣ ΣΥΝΔΕΣΗΣ ΜΕ ΤΟ ΠΡΟΪΟΝ, ΕΙΤΕ ΒΑΣΙΖΕΤΑΙ ΣΕ ΣΥΜΒΟΛΑΙΟ, ΒΛΑΒΗ, ΑΜΕΛΕΙΑ, ΑΥΣΤΗΡΗ ΕΥΘΥΝΗ Ή ΕΙΔΑΛΛΩΣ, ΑΚΟΜΗ ΚΙ ΕΑΝ Η EIZO Ή ΟΙ ΔΙΑΝΟΜΕΙΣ ΕΝΗΜΕΡΩΘΟΥΝ ΓΙΑ ΤΗΝ ΠΙΘΑΝΟΤΗΤΑ ΤΕΤΟΙΩΝ ΖΗΜΙΩΝ. Η ΕΞΑΙΡΕΣΗ ΑΥΤΗ ΠΕΡΙΛΑΜΒΑΝΕΙ ΕΠΙΣΗΣ ΟΠΟΙΟΔΗΠΟΤΕ ΕΥΘΥΝΗ ΕΝΔΕΧΕΤΑΙ ΝΑ ΠΡΟΚΥΨΕΙ ΑΠΟ ΑΞΙΩΣΕΙΣ ΤΡΙΤΟΥ ΜΕΡΟΥΣ ΚΑΤΑ ΤΟΥ ΑΡΧΙΚΟΥ ΑΓΟΡΑΣΤΗ. Η ΟΥΣΙΑ ΤΟΥ ΟΡΟΥ ΑΥΤΟΥ ΕΙΝΑΙ ΝΑ ΠΕΡΙΟΡΙΣΕΙ ΤΗΝ ΠΙΘΑΝΗ ΕΥΘΥΝΗ ΤΗΣ EIZO ΚΑΙ ΤΩΝ ΔΙΑΝΟΜΕΩΝ ΠΟΥ ΠΡΟΚΥΠΤΕΙ ΑΠΟ ΤΗΝ ΠΑΡΟΥΣΑ ΕΓΓΥΗΣΗ Ή/ΚΑΙ ΤΙΣ ΠΩΛΗΣΕΙΣ.

ОГРАНИЧЕННАЯ ГАРАНТИЯ

EIZO Corporation (называемая в дальнейшем **“EIZO”**) и авторизованные EIZO дистрибуторы (называемые в дальнейшем **“Дистрибуторы”**) гарантируют, в соответствии с условиями и пунктами этой ограниченной гарантии (называемой в дальнейшем **“Гарантия”**), первичному покупателю (называемому в дальнейшем **“Первоначальный покупатель”**), который приобрел у EIZO или Дистрибуторов продукт, указанный в этом документе (называемый в дальнейшем **“Продукт”**), что EIZO или Дистрибуторы на свое усмотрение либо бесплатно отремонтируют, либо бесплатно заменят Продукт, если Первоначальный покупатель признает в пределах Гарантийного срока (определенного ниже), что Продукт неисправен или он поврежден процессе нормального использования продукта в соответствии с описанием в инструкции по эксплуатации, прилагаемой к Продукту (называемой в дальнейшем **“Руководство пользователя”**).

Гарантийный период ограничен сроком (i) пять (5) лет от даты приобретения Продукта или ограничен сроком (ii) 30 000 часов использования Продукта (называемый в дальнейшем **“Гарантийный период”**). EIZO и Дистрибуторы не несут никакой ответственности и не берут обязательств относительно Продукта по отношению к Первоначальному покупателю или по отношению к любым третьим сторонам, кроме обязательств, оговоренных в этой Гарантии.

EIZO и Дистрибуторы прекратят хранение или складирование любых деталей Продукта по истечении семи (7) лет после прекращения производства таких деталей. В случае ремонта монитора EIZO и Дистрибуторы будут использовать запчасти, которые соответствуют нашим стандартам QC (контроль качества).

Гарантия действительна только в странах или регионах, где расположены Дистрибуторы. Гарантия не ограничивает никакие законные права Первоначального покупателя.

Несмотря на другие условия этой Гарантии EIZO и Дистрибуторы не несут никаких обязательств согласно этой Гарантии в любом из перечисленных ниже случаев:

- (а) Любые дефекты Продукта, вызванные повреждениями при перевозке, модификацией, изменением, неправильным обращением, неправильным использованием, авариями, неправильной установкой, стихийными бедствиями, неправильным уходом и/или неправильным ремонтом третьей стороной, отличной от EIZO или Дистрибуторов;
- (б) Любые несовместимости Продукта из-за технических усовершенствований и/или изменения технических норм;
- (в) Любое повреждение датчика;
- (г) Любые ухудшения работы дисплея, вызванные изнашиванием невосстановимых частей, таких как панель ЖКД и/или подсветка и т.д. (например, изменение в яркости, изменение в равномерности яркости, изменение в цветности, изменение в равномерности цветности, изменение в пикселях, включая выгоревшие пикселы и т.д.);
- (д) Любые дефекты Продукта, вызванные внешним оборудованием;
- (е) Любые дефекты Продукта, при которых оригинальный серийный номер был изменен или удален;
- (ж) Любые естественные ухудшения продукта, в частности, вызванные износом расходных частей, принадлежностей и/или приспособлений (например, кнопок, вращающихся частей, кабелей, Руководства пользователя и т.д.); и
- (з) Любые деформации, изменения цвета и/или коробления внешней поверхности продукта, включая поверхность панели ЖКД.

Чтобы получить техническое обслуживание в рамках Гарантии, Первоначальный покупатель должен доставить Продукт местному Дистрибутору, оплатив перевозку, в его оригинальной упаковке или в другой соответствующей упаковке, обеспечивающей равноценную степень защиты, принимая во внимание риск повреждения и/или утерю при транспортировке. При запросе технического обслуживания в рамках Гарантии Первоначальный покупатель должен предоставить свидетельство покупки продукта и даты покупки.

Гарантийный период для любого замененного и/или отремонтированного продукта в рамках Гарантии истекает в конце завершения срока действия оригинального Гарантийного периода.

EIZO ИЛИ ДИСТРИБУТОРЫ НЕ НЕСУТ ОТВЕТСТВЕННОСТИ ЗА ЛЮБЫЕ ПОВРЕЖДЕНИЯ ИЛИ УТЕРЮ ДАННЫХ ИЛИ ДРУГОЙ ИНФОРМАЦИИ, ХРАНЯЩИХСЯ НА КАКИХ-ЛИБО НОСИТЕЛЯХ ИНФОРМАЦИИ ИЛИ НА ЛЮБЫХ ДРУГИХ ЧАСТЯХ ПРОДУКТА, КОТОРЫЙ ВОЗВРАЩЕН EIZO ИЛИ ДИСТРИБУТОРАМ ДЛЯ РЕМОНТА.

EIZO И ДИСТРИБУТОРЫ НЕ ДАЮТ НИКАКОЙ ДАЛЬНЕЙШЕЙ ГАРАНТИИ, ВЫРАЖЕННОЙ ИЛИ ПОДРАЗУМЕВАЕМОЙ ОТНОСИТЕЛЬНО ПРОДУКТА И ЕГО КАЧЕСТВА, ТЕХНИЧЕСКИХ ХАРАКТЕРИСТИК, ТОВАРНОСТИ ИЛИ СООТВЕТСТВИЯ ДЛЯ КАКОГО-ЛИБО ОПРЕДЕЛЕННОГО ИСПОЛЬЗОВАНИЯ. НИ ПРИ КАКИХ УСЛОВИЯХ EIZO ИЛИ ДИСТРИБУТОРЫ НЕ НЕСУТ ОТВЕТСТВЕННОСТИ ЗА ЛЮБОЙ СЛУЧАЙНЫЙ, КОСВЕННЫЙ, СПЕЦИАЛЬНЫЙ, ПОБОЧНЫЙ ИЛИ ИНОЙ УЩЕРБ (ВКЛЮЧАЯ, БЕЗ ОГРАНИЧЕНИЙ, УЩЕРБ ИЗ-ЗА НЕПОЛУЧЕННОЙ ПРИБЫЛИ, ПРЕРЫВАНИЯ БИЗНЕСА, ПОТЕРИ КОММЕРЧЕСКОЙ ИНФОРМАЦИИ ИЛИ ЛЮБЫЕ ДРУГИЕ ФИНАНСОВЫЕ ПОТЕРИ), ВОЗНИКШИЙ ИЗ-ЗА ИСПОЛЬЗОВАНИЯ ИЛИ НЕВОЗМОЖНОСТИ ИСПОЛЬЗОВАТЬ ПРОДУКТ ИЛИ В ЛЮБОЙ ДРУГОЙ СВЯЗИ С ПРОДУКТОМ, ЛИБО ОСНОВАННЫЙ НА КОНТРАКТНЫХ ОТНОШЕНИЯХ, ГРАЖДАНСКИХ ПРАВОНАРУШЕНИЯХ, НЕБРЕЖНОСТИ, ПРИЧИНЕНИЯ УЩЕРБА ТРЕТЬЕЙ СТОРОНЕ ИЛИ ЧЕМ-ЛИБО ЕЩЕ, ДАЖЕ ЕСЛИ EIZO ИЛИ ДИСТРИБУТОРЫ БЫЛИ УВЕДОМЛЕНЫ О ВОЗМОЖНОСТИ ТАКОГО УЩЕРБА. ЭТО ИСКЛЮЧЕНИЕ ТАКЖЕ ВКЛЮЧАЕТ ЛЮБЫЕ ОБЯЗАТЕЛЬСТВА, КОТОРЫЕ МОГУТ ВОЗНИКНУТЬ В РЕЗУЛЬТАТЕ ТРЕБОВАНИЙ ТРЕТЬЕЙ СТОРОНЫ В ОТНОШЕНИИ ПЕРВОНАЧАЛЬНОГО ПОКУПАТЕЛЯ. СУЩЕСТВОМ ЭТОГО ПОЛОЖЕНИЯ ЯВЛЯЕТСЯ ОГРАНИЧЕНИЕ ПОТЕНЦИАЛЬНОЙ ОТВЕТСТВЕННОСТИ EIZO И ДИСТРИБУТОРОВ, ВОЗНИКАЮЩЕЙ ИЗ ЗА ЭТОЙ ОГРАНИЧЕННОЙ ГАРАНТИИ И/ИЛИ ПРОДАЖ.

有限责任保证书

EIZO Corporation (以下简称“EIZO”)和EIZO授权的经销商(以下简称“经销商”),接受并依照本有限责任保证书(以下简称“保证书”)之条款,向从EIZO和经销商购买本文中所规定产品(以下简称“产品”)的原买方(以下称“原买方”)提供保证:在保证期内(规定如下),如果原买方发现按本产品所附使用说明书(以下简称“用户手册”)所述方式正常使用本产品过程中,本产品出现故障或损坏,EIZO和经销商根据其独立的判断免费修理或更换该产品。

本保证期限定为(i)自本产品购买之日起的五(5)年期间或限定为到达(ii)使用本产品3万小时的期限(以下简称“保证期限”)。EIZO和经销商将不向原买方或任何第三方承担本保证书所规定之外的与本产品有关的任何责任或义务。

本产品的任何部件停产七(7)年后,EIZO和经销商将不再保留或保管任何这类部件。维修显示器时,EIZO与经销商将使用符合我方质量控制标准的替换零件。

本保证书仅对于设有经销商的国家或地区有效。本保证书并不限定原买方的任何法律权利。

无论本保证书的任何其他条款如何规定,对于任何下列情况之一,EIZO和经销商将不承担本保证书规定责任:

- (a) 由于运输损害、改装、改动、滥用、误用、意外事故、错误安装、灾害、维护不善和/或由除EIZO和经销商以外的第三方进行不适当的修理造成本产品的任何故障。
- (b) 由于可能发生的技术变更和/或调整造成本产品的任何不兼容性。
- (c) 传感器的任何劣化。
- (d) 由于诸如液晶显示屏(LCD)和/或背灯等消耗品部件的老化造成的任何显示性能低劣(如亮度变化、亮度均一性变化、色彩变化、色彩均一性变化、如烧伤像素等像素缺陷)。
- (e) 因外部设备造成本产品的任何故障。
- (f) 因本产品的原序号被改变或消除造成本产品的任何故障。
- (g) 本产品的任何正常老化,尤其是消耗品、附件和/或附加装置(如按钮、旋转部件、电缆、用户手册等)、以及
- (h) 本产品表面包括液晶显示屏(LCD)表面的任何变形、变色和/或翘曲。

为了获得本保证书规定的服务,原买方必须使用原包装或其他具有同等保护程度的适当包装将本产品运送到当地的经销商,并且预付运费,承担运输中的损坏和/或损失的风险。要求提供本保证书规定的服务时,原买方必须提交购买本产品和标明此购买日期的证明。

按本保证书规定进行了更换和/或修理的任何产品的保证期限,将在原保证期限结束时终止。

在返回给EIZO和经销商进行修理后,任何产品的任何媒体或任何部件中储存的数据或其他信息发生任何损坏或损失,对此EIZO和经销商将不承担责任。

对于本产品及其质量、性能、可销售性以及对于特殊用途的适合性,EIZO和经销商不提供其他任何明示或暗示的保证。因使用本产品或无法使用本产品或因与本产品有任何关系(无论是否根据合同)而造成:任何附带的、间接的、特殊的、随之发生的或其他的损害(包括但不限于利润损失、业务中断、业务信息丢失或其他任何金钱损失)以及侵权行为、过失、严格赔偿责任或其他责任,即使已经向EIZO和经销商提出了发生这些损害的可能性,对此EIZO和经销商概不承担责任。本免责条款还包括因第三方向原买方提出索赔而可能发生的任何责任。本条款的本质是限定由于本有限责任保证书和/或销售本产品所发生的EIZO和经销商的潜在责任。

Recycling Information

This product, when disposed of, is supposed to be collected and recycled according to your country's legislation to reduce environmental burden. When you dispose of this product, please contact a distributor or an affiliate in your country.

The contact addressees are listed on the EIZO website below.

<http://www.eizo.com>

For recycling information for customers in Switzerland, please refer to the following website.

<http://www.swico.ch>

Informationen zum Thema Recycling

Dieses Produkt muss gemäß den Vorschriften Ihres Landes zur Entlastung der Umwelt recyclet werden. Wenden Sie sich bei der Entsorgung dieses Produkts an einen Verteiler oder eine Tochtergesellschaft in Ihrem Land.

Die Adressen zur Kontaktaufnahme sind auf der unten angegebenen Website von EIZO aufgeführt.

<http://www.eizo.com>

Kunden in der Schweiz entnehmen Informationen zum Recycling der folgenden Website:

<http://www.swico.ch>

Informations sur le recyclage

Ce produit doit être jeté aux points de collecte prévus à cet effet et recyclé conformément à la législation de votre pays, afin de réduire l'impact sur l'environnement. Lorsque vous jetez ce produit, veuillez contacter un distributeur ou une société affiliée de votre pays.

Les adresses des distributeurs sont répertoriées sur le site Web EIZO ci-dessous.

<http://www.eizo.com>

Pour les clients en Suisse, veuillez consulter le site Web suivant afin d'obtenir des informations sur le recyclage.

<http://www.swico.ch>

Información sobre reciclaje

Este producto debe desecharse y reciclarse según la legislación del país para reducir el impacto medioambiental. Cuando desee deshacerse de este producto, póngase en contacto con un distribuidor o una filial de su país.

Encontrará las direcciones de contacto en el sitio web de EIZO que se indica a continuación.

<http://www.eizo.com>

Informazioni sul riciclaggio

Per lo smaltimento e il riciclaggio del presente prodotto, attenersi alle normative vigenti nel proprio paese per ridurre l'impatto ambientale. Per lo smaltimento, rivolgersi ad un distributore o un affiliato presenti nel proprio paese.

Gli indirizzi sono elencati nel sito Web EIZO riportato di seguito.

<http://www.eizo.com>

Per informazioni sul riciclaggio per i clienti in Svizzera, consultare il sito Web riportato di seguito.

<http://www.swico.ch>

Återvinningsinformation

När denna produkt kasseras ska den hanteras och återvinnas enligt landets föreskrifter för att reducera miljöpåverkan. När du kasserar produkten ska du kontakta en distributör eller representant i ditt land.

Kontaktadresserna listas på EIZO-webbplatsen nedan.

<http://www.eizo.com>

Πληροφορίες ανακύκλωσης

Το προϊόν αυτό, όταν απορρίπτεται, πρέπει να συλλέγεται και να ανακυκλώνεται σύμφωνα με τη νομοθεσία της χώρας σας έτσι ώστε να μην επιβαρύνει το περιβάλλον. Για να απορρίψετε το προϊόν, επικοινωνήστε με έναν αντιπρόσωπο ή μια θυγατρική εταιρεία στη χώρα σας.

Οι διευθύνσεις επικοινωνίας αναγράφονται στην τοποθεσία web της EIZO παρακάτω.

<http://www.eizo.com>

Сведения по утилизации

По истечении срока службы данного продукта его следует принести на сборный пункт и утилизировать в соответствии с действующими предписаниями в вашей стране, чтобы уменьшить вредное воздействие на окружающую среду. Прежде чем выбросить данный продукт, обратитесь к дистрибьютору или в местное представительство компании в вашей стране.

Контактные адреса можно найти на веб-узле EIZO.

<http://www.eizo.com>

Informatie over recycling

Wanneer u dit product wilt weggooien, moet het uit milieu-overwegingen worden verzameld en gerecycled volgens de betreffende wetgeving van uw land. Wanneer u dit product wilt weggooien, moet u contact opnemen met een distributeur of een partner in uw land.

De contactadressen worden vermeld op de volgende EIZO-website.

<http://www.eizo.com>

Informação sobre reciclagem

Este produto, quando o deitar fora, deve ser recolhido e reciclado de acordo com a legislação do seu país para reduzir a poluição. Quando deitar fora este produto, contacte um distribuidor ou uma filial no seu país.

Os endereços de contacto estão listados no website do EIZO, abaixo.

<http://www.eizo.com>

Oplysninger om genbrug

Denne produkt forventes ved bortskaffelse at blive indsamlet og genbrugt i overensstemmelse med lovgivningen i dit land for at reducere belastningen af miljøet. Når du bortskaffer denne produkt, skal du kontakte en distributør eller et tilknyttet selskab i dit land.

Adresserne på kontaktpersonerne er angivet på EIZO's websted nedenfor.

<http://www.eizo.com>

Kierrätystä koskevia tietoja

Tuote tulee hävittää kierrättämällä maan lainsäädännön mukaisesti ympäristön kuormittumisen vähentämiseksi. Kun hävität tuotteen, ota yhteyttä jälleenmyyjään tai tytäryhtiöön maassasi.

Yhteystiedot löytyvät EIZOn Internet-sivustolta.

<http://www.eizo.com>

Wykorzystanie surowców wtórnych

Ten produkt po zużyciu powinien być zbierany i przetwarzany zgodnie z krajowymi przepisami dotyczącymi ochrony środowiska. Wyrzucając ten produkt, należy skontaktować się z lokalnym dystrybutorem lub partnerem. Adresy kontaktowe można znaleźć we wskazanej poniżej witrynie internetowej firmy EIZO.

<http://www.eizo.com>

Informace o recyklaci

Při likvidaci produktu musí být produkt vyzvednut a recyklován podle zákonů příslušné země, aby nedocházelo k zatěžování životního prostředí. Zbavujete-li se produktu, kontaktujte distributora nebo pobočku ve své zemi. Kontaktní adresy jsou uvedeny na následující webové stránce společnosti EIZO.
<http://www.eizo.com>

Ringlussevõtu alane teave

Keskkonnakoormuse vähendamiseks tuleks kasutatud tooted kokku koguda ja võtta ringlusse vastavalt teie riigi seadustele. Kui kõrvaldate käesoleva toote, võtke palun ühendust turustaja või filiaaliga oma riigis. Kontaktisikud on toodud EIZO veebilehel järgmisel aadressil:
<http://www.eizo.com>

Újrahasznosítási információ

Jelen terméket, amikor eldobjuk, az illető ország törvényei alapján kell összegyűjteni és újrahasznosítani, hogy csökkentsük a környezetet terhelését. Amikor ezt a terméket eldobja, kérjük lépjen kapcsolatba egy országon belüli forgalmazóval vagy társvállalkozással.
A kapcsolat címei az EIZO alábbi weboldalán találhatók felsorolva:
<http://www.eizo.com>

Podatki o recikliranju

Ob koncu uporabe odslužen izdelek izročite na zbirno mesto za recikliranje v skladu z okoljevarstveno zakonodajo vaše države. Prosimo, da se pri odstranjevanju izdelka obrnete na lokalnega distributerja ali podružnico.
Kontaktne naslovi so objavljeni na spodaj navedenih spletnih straneh EIZO:
<http://www.eizo.com>

Informácie o recyklácii

Pri likvidácii musí byť tento výrobok recyklovaný v súlade s legislatívou vašej krajiny, aby sa znížilo zaťaženie životného prostredia. Keď sa chcete zbaviť tohto výrobku, kontaktujte prosím distribútora alebo pobočku vo vašej krajine.
Zoznam kontaktných adries je uvedený na nasledovnej webovej stránke firmy EIZO:
<http://www.eizo.com>

Pārstrādes informācija

Utilizējot šo produktu, tā savākšana un pārstrāde veicama atbilstoši jūsu valsts likumdošanas prasībām attiecībā uz slodzes uz vidi samazināšanu. Lai veiktu šī produkta utilizāciju, sazinieties ar izplatītāju vai pārstāvniecību jūsu valstī.
Kontaktadrese ir norādītas zemāk minētajā EIZO tīmekļa vietnē.
<http://www.eizo.com>

Informacja apie gražinamąjį perdirbimą

Šalinant (išmetant) šiuos gaminius juos reikia surinkti ir perdirbti gražinamuoju būdu pagal jūsų šalies teisės aktus, siekiant sumažinti aplinkos teršimą. Kai reikia išmesti šį gaminį, kreipkitės į jūsų šalyje veikiančią gaminių pardavimo atstovybę arba jos filialą.
Kontaktiniai adresatai nurodyti EIZO interneto svetainėje.
<http://www.eizo.com>

Информация относно рециклиране

При изхвърлянето на този продукт се предлага събирането и рециклирането му съобразно законите на вашата страна за да се намали замърсяването на околната среда. Когато искате да се освободите от този продукт, моля свържете се с търговския му представител или със съответните органи отговарящи за това във вашата страна.

Данните за връзка с нас са описани на следния Интернет сайт на EIZO:
<http://www.eizo.com>

Informație referitoare la reciclare

Acest produs, când debarasat, trebuie colectat și reciclat conform legislației țării respective ca să reducem sarcina mediului. Când se debarasează de acest produs, vă rugăm să contactați un distribuitor sau un afiliat al țării respective.

Adresele de contact le găsiți pe pagina de web al EIZO:
<http://www.eizo.com>

معلومات عن إعادة التدوير

عند التخلص من هذا المنتج، من الضروري تجميعه وإعادة تدويره وفقاً للقوانين المتبعة في بلدك لتقليل العبء المسلط على البيئة. عندما تتخلص من هذا المنتج، يرجى الاتصال بموزع أو طرف متنسب إليه في بلدك. عناوين الاتصال مدرجة في موقع ايزو EIZO ادناه على شبكة الانترنت.

<http://www.eizo.com>

Geri Dönüşüm Bilgisi

Bu ürünün, atılacağı zaman, ülkenizin çevre kirliliğinin azaltılması konusundaki mevzuatına göre toplanması ve yeniden değerlendirilmesi gerekmektedir. Ürünü atacağınız zaman lütfen ülkenizdeki bir distribütör veya ilgili kuruluşla temasa geçiniz.

İrtibat adresleri aşağıdaki EIZO web sitesinde verilmiştir.
<http://www.eizo.com>

关于电子信息产品污染控制标识



本标识根据「电子信息产品污染控制管理办法」，适用于在中华人民共和国销售的电子信息产品。标识中央的数字为环保使用期限的年数。只要您遵守该产品相关的安全及使用注意事项，在自制造日起算的年限内，不会产生对环境污染或人体及财产的影响。上述标识粘贴在机器背面。

• 有毒有害物质或元素的名称及含量

部件名称	有毒有害物质或元素					
	铅 (Pb)	汞 (Hg)	镉 (Cd)	六价铬 (Cr (VI))	多溴联苯 (PBB)	多溴二苯醚 (PBDE)
印刷电路板	×	○	○	○	○	○
机箱	○	○	○	○	○	○
液晶显示器	×	○	○	○	○	○
其他	×	○	○	○	○	○

○：表示该有毒有害物质在该部件所有均质材料中的含量均在 SJ/T 11363-2006 规定的限量要求以下。
 ×：表示该有毒有害物质至少在该部件的某一均质材料中的含量超出 SJ/T 11363-2006 规定的限量要求。
 （企业可在此处，根据实际情况对上表中打“×”的技术原因进行进一步说明）

