



CONFIGURATION AND OPERATION MANUAL

**SilverBack V
&
SilverBack-VB**

CAMERA-MOUNTABLE FIBER OPTIC TRANSMISSION SYSTEM

252 INDIAN HEAD RD
KINGS PARK, NY 11754 USA
(877) 685-8439 / (516) 671-7278 / FAX (516) 671-3362
sales@multidyne.com
www.multidyne.com

SilverBack V Camera-Mountable Fiber Optic Transmission System

MULTIDYNE, the MultiDyne logo, are registered trademarks of MultiDyne Electronics, Inc.

Copyright 2024 MULTIDYNE ELECTRONICS, INC. KINGS PARK, NEW YORK

Printed in the United States of America.

All Rights Reserved.

Contents of this publication may not be reproduced in any form without the written permission of
MultiDyne Electronics, Inc.

This product was designed and manufactured in the UNITED STATES OF AMERICA.

TABLE OF CONTENTS

TABLE OF CONTENTS	2
IMPORTANT SAFETY INSTRUCTIONS	4
LASER SAFETY INFORMATION	6
OVERVIEW	7
SilverBack V Family	7
SilverBack V Camera Unit	7
SilverBack V Base Unit	8
INSTALLATION	9
Camera Unit Installation	9
Base Unit Installation	9
CONNECTIONS: BASE UNIT	12
Camera Fiber Connectors	12
SMPTE 304M LEMO Hybrid Fiber Connector Systems	12
Neutrik opticalCON DUO Hybrid Fiber Connector Systems	13
ST Connector Systems	13
ST & Molex Connector Systems	14
Signal I/O Connections	15
4K Camera Video Connections	15
Secondary SDI Connections	15
Reference Sync Connections	15
Timecode Connections	15
Camera Ethernet Connections	16
Intercom, Tally, and GPIO Connections	16
Audio Connections	16
Serial Data Connections	17
Frame Controller Connection	17
CONNECTIONS: CAMERA UNIT	18
Camera Unit Connectors	18
4K Camera Video Connections	18
Camera Reference Sync Connections	19
Timecode Connections	19
Secondary SDI Connections	19
Built-in Viewfinder Switch	19
Ethernet Connection	20
Intercom Headset Connection	20
Audio Connections	20
Tally and GPIO Connections	21
Serial Data Connections	21
D-Tap Power Connections	22

CAMERA UNIT OPERATION	23
Control Panel Indicators and Controls	23
Control Panel Navigation	24
CONTROL PANEL: STATUS SCREENS	25
General Instructions	25
Status Screens	25
Home Screen	25
Optical Status Screen	26
Power Status Screen	26
CONTROL PANEL: CAMERA UNIT MENUS	28
General Instructions	28
Main Menu	28
Video Settings	28
Audio Settings	30
Serial Data Settings	35
System Settings	35
Saving and Recalling Settings	38
BASE UNIT OPERATION	39
Front Panel Indicators and Controls	39
BASE UNIT MENUS	40
General Instructions	40
SBV System Status	40
Base Unit Root Menu	40
Gearbox Configuration and Operation	42
Audio Input Configuration	44
Audio Output Configuration	45
Intercom Configuration	46
Reference and Timecode Configuration	47
Serial Data Configuration	47
Base Unit Network Configuration	48
IP Address Settings	48
Firmware Updates	50
Saving and Recalling Settings	51
APPENDIX A - TECHNICAL SPECIFICATIONS	52
Connector Pinouts – Camera Unit	60
Connector Pinouts – Base Unit	62
APPENDIX B - TROUBLESHOOTING	64
Cable Cleaning Procedure	64
APPENDIX C - Updating System software	66
Overview	66
Base Unit Update Process	67
Camera Unit Update Process	69

IMPORTANT SAFETY INSTRUCTIONS

- Read these instructions.
- Keep these instructions.
- Heed all warnings.
- Follow all instructions.
- Do not use this apparatus near water.
- Clean only with dry cloth.
- Do not block any ventilation openings. Install in accordance with the manufacturer's instructions.
- Do not install near any heat sources such as radiators, heat registers, stoves, or other apparatus (including amplifiers) that produce heat.
- Do not defeat the safety purposes of the grounding-type plug. A ground-type plug has two blades and a third grounding prong. The third prong is provided for your safety. If the provided plug does not fit into your outlet, consult an electrician for replacement of the obsolete outlet.
- Protect the power cord from being walked on or pinching, particularly at plugs, convenience receptacles, and points where they exit from the apparatus.
- Only use attachments/accessories specified by the manufacturer.
- Use only with the cart, stand, tripod, bracket, or table specified by the manufacturer, or sold with the apparatus. When a cart is used, use caution when moving the cart/apparatus combination to avoid injury from tip-over.
- Unplug this apparatus during lightning storms or when unused for long periods of time.
- Refer all servicing to qualified service personnel. Servicing is required when the apparatus has been damaged in any way, such as a damaged power-supply cord or plug, liquid has been spilled or objects have fallen into the apparatus, the apparatus has been exposed to rain or moisture, does not operate normally, or has been dropped.
- Throughout this manual, a number of warning and caution notes may be presented to alert the user to important safety or operating information. Please read and comply with any and all of the following warning and caution notes:



Warnings indicate danger that requires proper procedures or practices to prevent injury or death to personnel.



Cautions indicate proper procedures or practices to prevent damage to equipment or property.



Warning – The safe operation of this product requires that a protective earth connection be provided. A grounding conductor in the equipment's mains supply cord provides this protective earth. To reduce the risk of electrical shock to the operator and service personnel, this ground conductor must be connected to an earthed ground. The mains plug shall remain readily operable.

- Always adhere to local building, safety and fire prevention codes during the installation and operation of this product.
- Use only power cords specified for this product and certified for the country of use.
- Connect the unit only to a power source with the specified voltage rating.
- Connect the unit only to a power source with suitable surge suppression.
- Use only fuses of the type and rating specified.
- In case of an emergency ensure that power is disconnected.



Warning – The apparatus shall not be exposed to dripping or splashing, and no objects filled with liquids, such as vases, shall be placed on the apparatus.



Warning – This symbol indicates that the apparatus should not be used at altitudes exceeding 2000 m.



Warning – Waste Electrical and Electronic Equipment Directive (WEEE Directive) - Please contact your local authority for further details of your nearest designated collection point. Penalties may be applicable for incorrect disposal of this waste, in accordance with your national legislation.

LASER SAFETY INFORMATION

This unit is classified as a **CLASS 1 LASER PRODUCT** according to EN60825-1 (EU) and FDA 21CFR 1040.10 (USA). Class 1 laser products are considered safe and do not result in biological hazard if used according to these instructions.

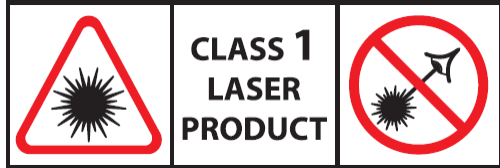

Warning – Use of controls, adjustments, or performance of procedures other than those specified herein may result in hazardous radiation exposure.



Warning – Never look directly into the end of the optical fiber while either end of the system is operating.



Warning – Never clean an optical fiber connector on equipment or cable that is carrying light.



Warning – Always use dust caps on fiber optic connectors when cables are not connected. This will protect the connector from damage and accidental exposure of a human eye to an operating laser.

OVERVIEW

The SilverBack™ V camera-mountable fiber optic transmission system provides a robust, full-bandwidth link between any 12G, quad-link or dual-link 4K camera and your truck, OB van, control room, flypack, or “video village” position. The system aggregates all of the signals needed for multi-camera 4K/UHD production onto a single tactical or SMPTE hybrid fiber cable, ensuring robust, trouble-free connectivity between a remote production and studio.

The SilverBack V can transport up to one 12G-SDI, two 6G-SDI, or four 3G-SDI signals from a camera to its rack-mounted base station, with one return path. Full camera control is provided by the camera manufacturer’s control panel via serial or a 10/100/GigE Ethernet path. Genlock, intercom, tally, and audio paths are also provided. You can operate the unit using a hybrid cable which simultaneously provides power to the camera, or you can use lightweight, robust tactical fiber and power the camera locally.

SilverBack V Family

There are several models of SilverBack V, each with slightly different features and capabilities. Review this chart to ensure that your model has the particular feature you require.

Feature	Signal Flow Direction		SBV-3EO	SBV-3GX	SBV-2X2	SBV-3X3	SBV-4K1	SBV-4K2	SBV-42	SBV-44
	Camera	Base	Signal Count	Signal Count	Signal Count	Signal Count	Signal Count	Signal Count	Signal Count	Signal Count
UHD Gearbox	>		0	0	0	0	1	1	1	1
3G-SDI	>		1	1	2	3	1	2	0	0
3G-SDI	<		1	1	2	3	1	2	2	4
Reference	<		0	1	1	1	1	1	1	1
Timecode	<	>	0	1	1	1	1	1	1	1
Audio	<	>	0	4	4	4	4	4	4	4
Intercom	<	>	0	2	2	2	2	2	2	2
Tally	<		0	2	2	2	2	2	2	2
GPIO	<	>	0	1	1	1	1	1	1	1
Ethernet	<	>	1	1	1	1	1	1	1	1
Serial Data	<	>	0	2	2	2	2	2	2	2

SilverBack V Camera Unit

The SilverBack V camera unit connects to the camera's rear battery mount. The device's OLED display provides clarity and easy access to configure system parameters, adjust intercom levels, and troubleshoot.

SilverBack V Base Unit

The SilverBack V base unit interfaces up to two cameras and accessories via lightweight tactical fiber cable or with SMPTE hybrid fiber cable to deliver all of your signals and the power to run your cameras and accessories. Separate internal power supplies provide power for each camera chain, and there are redundant power supplies for power within the base unit.

The base unit front panel's simple interface lets the operator easily monitor system link and signal status via a TFT display. Dedicated status LEDs permit easy monitoring of key signal levels, and a menu system on the TFT display allows detailed status and configuration of system parameters.

SYSTEM INSTALLATION



AC POWER 1: Camera 1 and base unit power

AC POWER 2: Camera 2 and base unit power

Camera Unit Installation

Connect the SilverBack V control unit to your camera's Anton Bauer or V-mount battery connector. Click into place to ensure that the unit is secure.

Base Unit Installation

Before cabling, ensure that the SilverBack V base unit is clear of wiring, equipment, and other obstructions. When mounting the base unit into a rack, allow at least 1 RU of open space above to ensure proper cooling.

Integrating SilverBack V with Your Facility

A. Tactical Fiber Cable — Camera Powered Locally

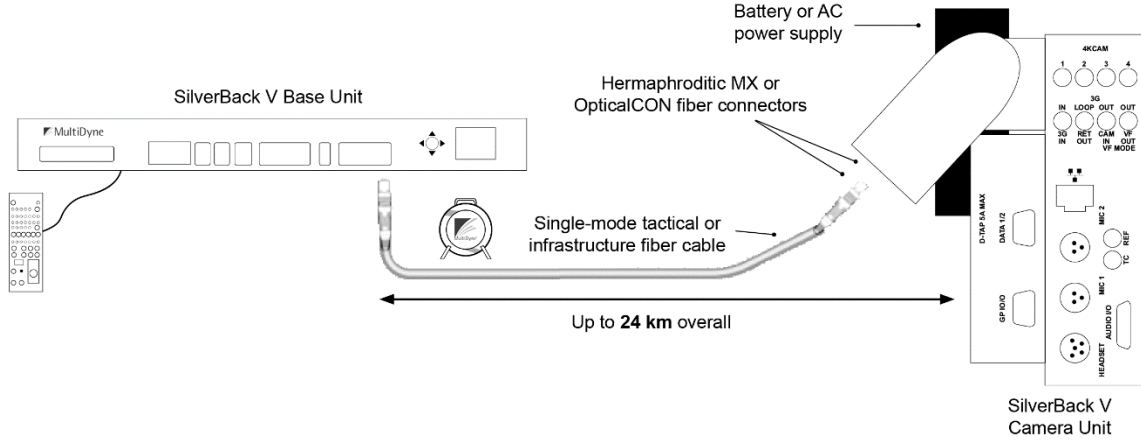

B. SMPTE Hybrid Fiber — Standard Internal “Juice” Power Supply

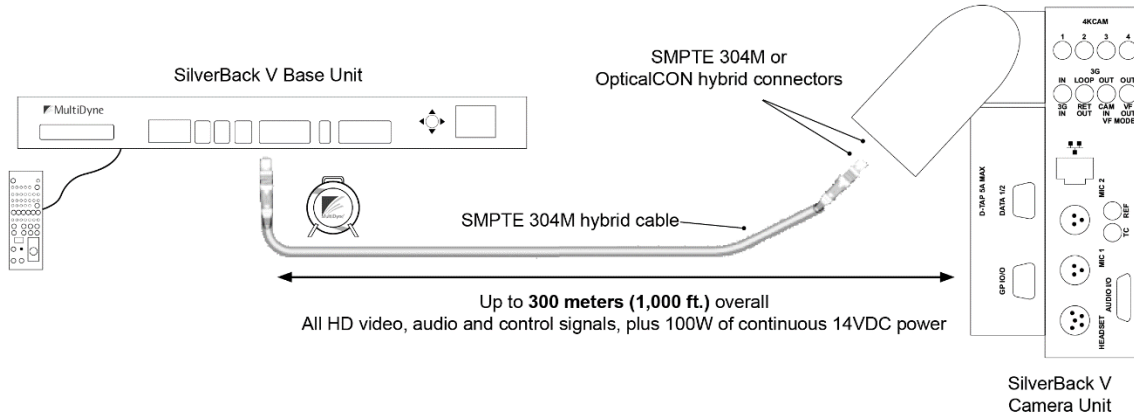

C. SMPTE Hybrid Fiber — External “Juice-48” Power Supply

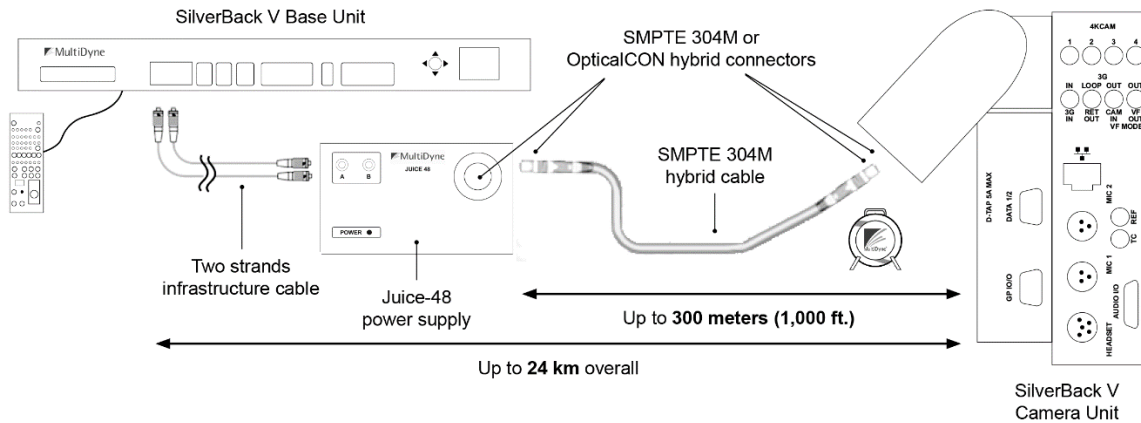

Maximum powered hybrid fiber distance varies and is determined by the size of the hybrid cable and the overall system power requirements. Power consumption of the camera, viewfinder, lens, and any other accessories will affect maximum available power at any given distance.

Hybrid Fiber Power vs. Distance

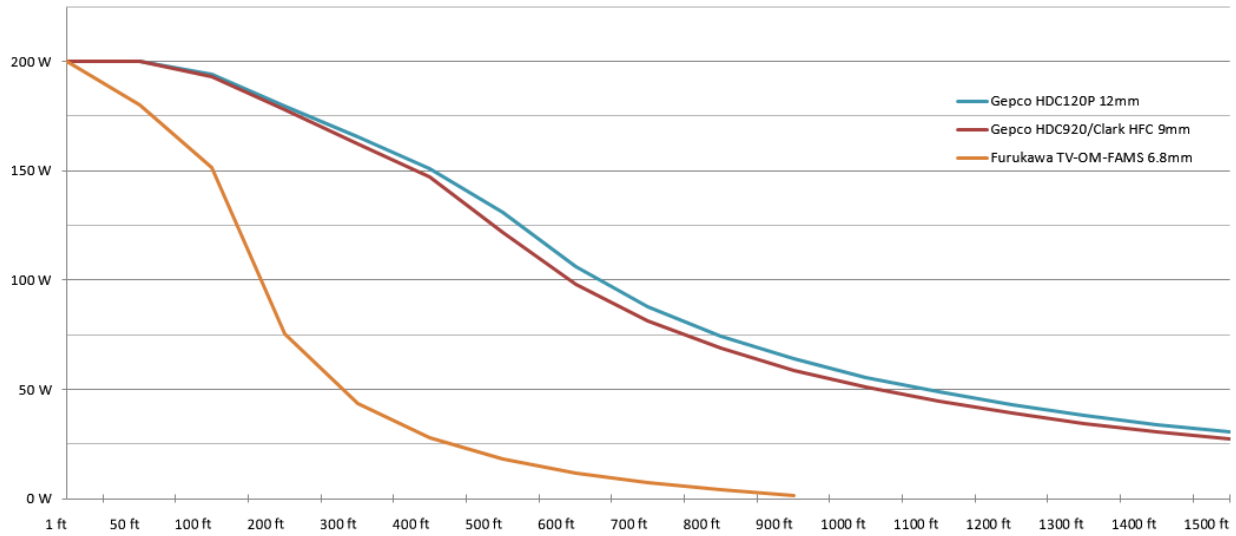

CONNECTIONS: BASE UNIT

The following section describes connections to the base unit. Depending on the type of SilverBack V system ordered, some of the signal types may not be available.



Base Unit System Example: SB5-B4K1-SPPJ-UB2R-2

Camera Fiber Connectors

The SilverBack V base unit can be ordered with various types of fiber-optic connectors for interfacing with the camera unit.

SMPTE 304M LEMO Hybrid Fiber Connector Systems

Systems with SMPTE 304M connectors typically provide both fiber-optic connectivity to the camera and power to the camera system. Connect the camera units to these ports using SMPTE 311M cabling. It is recommended to power off the base unit, where possible, before connecting hybrid fiber cable to the camera unit.

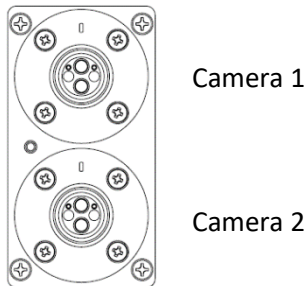

Neutrik opticalCON DUO Hybrid Fiber Connector Systems

Systems with Neutrik opticalCON DUO connectors typically provide both fiber-optic connectivity to the camera and power to the SilverBack V camera unit. Connect the camera units to these ports using opticalCON DUO cabling. It is recommended to power off the base unit, where possible, before connecting hybrid fiber cable to the camera unit.

Base units without camera power are also available with OpticalCON DUO connectors. For these systems, either opticalCON DUO cables or single-mode fiber (tactical) with LC/UPC connectors may be used.

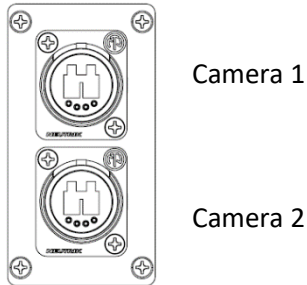

ST Connector Systems

Systems with ST fiber connectors do not provide power to the SilverBack V camera unit. Connect the camera units to these ports using ST/UPC single-mode fiber (tactical). Power for the camera units must be provided locally at the camera or by using a “juice” power supply and hybrid-fiber cabling on the final fiber run to the camera.

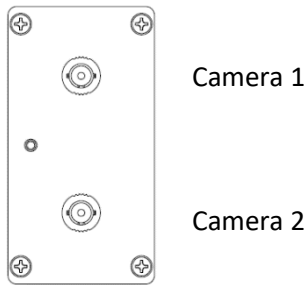

ST & Molex Connector Systems

Systems with ST and Molex connectors provide both fiber-optic connectivity to the camera and power to the SilverBack V camera unit. This configuration allows for custom breakout wiring and is typically used where multiple systems are connected to a local patch panel, where they make the transition to standard hybrid-fiber cabling. It is recommended to power off the base unit, where possible, before connecting hybrid fiber cable to the camera unit.

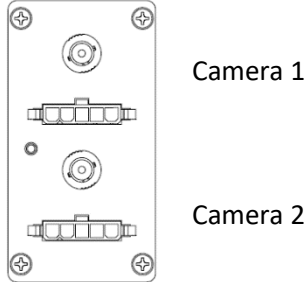

The Molex connector on the SilverBack V chassis is a five-pin male Molex Mini-Fit Jr p/n 39-01-4053 (MDCON04787) or equivalent. This configuration requires Molex p/n 39-00-0041 (MDCON04799) crimp pins. The mate for the chassis connector on a breakout cable is Molex Mini-Fit Jr p/n 39-01-4051 (MDCON04818) or equivalent. This configuration requires Molex p/n 39-00-0039 (MDCON04817) crimp pins.

Molex Pin #	Description	Neutrik OpticalCON DUO Connector Pin #	Lemo SMPTE Connector Pin Color
1	54VDC Out +	4	Black
2	54VDC Out +	2	Red
3	Chassis Ground (Shield)	Tab	Green (Shield)
4	54VDC Out -	3	Grey
5	54VDC Out -	1	White

Signal I/O Connections

4K Camera Video Connections

The 4K CAM outputs on the base unit are highlighted in blue and are capable of outputting single-link, dual-link, and quad-link SDI formats, supporting SD, HD, and 4K resolutions up to 4Kp60. Connect the 4K CAM outputs of the base unit to the desired facility destination. Depending on the type of camera and video resolution, up to four HD-BNC cables may be needed.

HDBNC #	Signal	4K Application		
		Single Link	Dual Link	Quad Link
1	12G/6G/3G/1.5G with gearbox	Single Link	Dual Link	Quad Link
2	6G/3G/1.5G with gearbox	X		
3	3G/1.5G with gearbox			
4	3G/1.5G with gearbox		X	

The base unit video settings will need to be set to match the camera's output video format. Please refer to the configuration and operations section for more information.

Secondary SDI Connections

The SilverBack V base unit is equipped with one or more secondary SDI paths, which function as camera sends, returns, or both. These SDI connections only support data rates up to 3G (they are not 6G or 12G capable).

The number of secondary SDI connections on the base unit and their directions varies from model to model. These secondary SDI connections on the base unit are highlighted in green, and the label indicates their direction.

Reference Sync Connections

Each camera chain in the SilverBack V base unit has a dedicated reference sync input. Connect the desired sync reference to these ports. This REF input can accept an analog NTSC, PAL, or HD tri-level signal. On older units, these inputs are loop-thru and require a 75-ohm termination on the loop-thru connector or at the end of the loop. Current units are internally terminating and do not require external termination.

If the camera requires SDI reference, use one of the 3G-SDI return inputs on each of the camera chains of the base unit.

Timecode Connections

Each camera chain in the SilverBack V base unit has dedicated timecode inputs and outputs. Connect timecode inputs and outputs to these ports, as necessary. Note that in order for a camera chain in the base unit to output the camera's timecode, the direction of the timecode connector on the camera unit must be set as an input.

Camera Ethernet Connections

Each camera chain in the SilverBack base unit has a dedicated Ethernet path for the camera unit. These paths are capable of 10/100/1000 Mbps operation and each contains an internal Ethernet switch, providing two ports for connectivity at the base station. The use of Cat5e or Cat6 cables is recommended.

Intercom, Tally, and GPIO Connections

Each camera chain in the SilverBack V base unit has a dedicated DB25 connector for intercom, tally, and GPIO connections. This connector follows the standard pinout used by Sony and Panasonic CCUs and supports 2-wire or 4-wire intercom systems.

Red and green tallies, as well as a GPIO in each direction, are provided. Tallies and GPIs expect a contact-closure to ground to activate, and the GPO provides a contact-closure to ground when activated at the camera unit. See pinouts for more details. Pre-made breakout cables are available for 2-wire and 4-wire intercom systems.

Part Number	Description
BO-4WICTAL-SB5-1M	SilverBack V base station 4-Wire intercom and tally breakout cable
BO-RTS2W-ICTAL-SB5-1M	SilverBack V base station 2-Wire RTS intercom and tally breakout cable
BO-CC2W-ICTAL-SB5-1M	SilverBack V base station 2-Wire ClearCom intercom and tally breakout cable

Audio Connections

Each camera chain in the SilverBack base unit has a dedicated DB25 connector, providing a bidirectional four-channel audio interface with the camera. These inputs and outputs may be configured as either analog line level or AES on a stereo-pair basis using the System menu.

The audio DB25 connector follows the Tascam channel-numbering convention, designating the first four channels as audio inputs and the last four channels as audio outputs. When using AES, only the odd numbered channels are used. See pinouts for more details. A pre-made breakout cable to XLR connectors is available.

Part Number	Description
BO-TASCAM4X4-XLR-10F	DB25M to 4 XLR-3F and 4 XLR3-M, 10 ft.

Serial Data Connections

Each camera chain in the SilverBack base unit is equipped with two dedicated user-configurable serial data ports to control cameras or other peripherals. These DB-9 serial data ports support RS232, RS422, LANC, and TTL level data. See pinouts for more details. Pre-made cables for specific camera and RCP manufacturers are available.

Part Number	Description
MDCAB00160	Cable Assembly, SilverBack V, base station-side RCP, for Sony 8-pin. 10' long, DB9 male to Hirose MXR series 8-pin male.
MDCAB00180	Cable Assembly, SilverBack V, base station-side RCP, for Panasonic 10-pin. 10' long, DB9 male to Hirose HR10A series 10-pin female.
MDCAB01068	Cable Assembly, SilverBack V, base station-side RCP, for Cannon LANC RCP. 10' long, DB9 male to 3.5mm male plug.
MDCAB01256	Cable Assembly, SilverBack V, base station-side RCP, for Sony FS9 LANC. 10' long, DB9 male to 2.5mm female jack.

Frame Controller Connection

The frame controller in the SilverBack V base unit can be accessed via its 10/100 Mbps Ethernet port. Connect this port to your facility network using Cat5e/Cat6 cabling.

The exact steps for connecting to your facility via an Ethernet network depends on the network requirements of your facility. Contact your IT department before connecting to your facility network to ensure that there are no IP address conflicts.

CONNECTIONS: CAMERA UNIT

Camera Unit Connectors

The following section describes connections to the SilverBack V camera unit. Depending on the type of system ordered, some of the signal types may not be available. The SilverBack V camera unit is installed on the camera by sliding it onto the camera's V-mount or Anton Bauer battery plate until it clicks and locks into place.

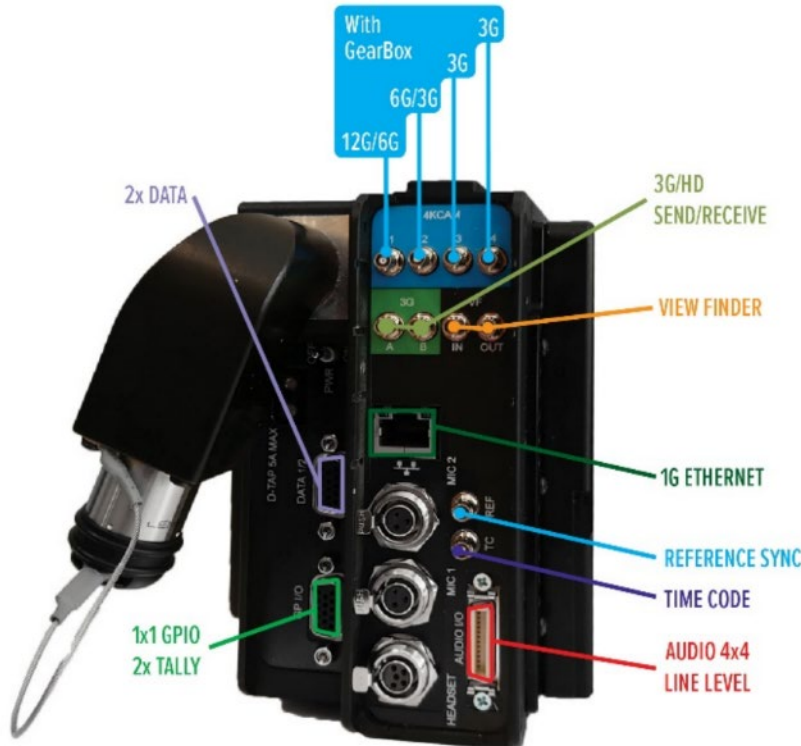

Camera Unit System Example: SB5-C4K1-SPPJ-5CVV

4K Camera Video Connections

The 4K CAM inputs on the camera unit are highlighted in blue and are capable of accepting single-link, dual-link, and quad-link SDI formats, supporting SD, HD, and 4K resolutions up to 4Kp60. Connect the 4K CAM inputs of the camera unit to the camera's 4K video outputs. Depending on the type of camera and video resolution, up to four HD-BNC cables may be needed.

HDBNC #	Signal	4K Application		
1	12G/6G/3G/1.5G with gearbox	Single Link	Dual Link	Quad Link
2	6G/3G/1.5G with gearbox	X		
3	3G/1.5G with gearbox			
4	3G/1.5G with gearbox		X	

The camera unit video settings will need to be set to match the camera's output video format. Please refer to the Configuration and Operations section of this manual for more information.

Camera Reference Sync Connections

Connect the SilverBack V camera unit REF output to camera REF/SYNC input using a BNC to HD-BNC cable. A valid analog black burst or tri-level signal must be connected to the base unit REF input to provide this reference signal to the camera.

If the camera requires SDI reference, connect one of the 3G SDI return outputs on the SilverBack V camera unit to the REF input on the camera. A valid SDI signal must be connected to the base unit on this return path to provide this SDI reference to the camera.

Timecode Connections

The SilverBack V camera unit has a single HDBNC connector for timecode, and the port direction is configured as either an input or output in the system menus. Connect the timecode connector on the SilverBack V camera unit to the appropriate timecode connector on the camera based on the desired workflow.

Some cameras utilize a single connector for timecode. In this case, ensure that the timecode port direction on the camera is set accordingly.

Secondary SDI Connections

The SilverBack V camera unit is equipped with one or more secondary SDI paths, which function as camera sends, returns, or both. These SDI connections only support data rates up to 3G (they are not 6G or 12G capable).

The number of secondary SDI connections on the camera unit and their directions varies from model to model. These secondary SDI connections on the camera unit are highlighted in green and the label indicates their direction. On certain models, some of the secondary SDI connections can be re-assigned in the settings menu to connect to a built-in internal viewfinder switch.

Built-in Viewfinder Switch

On certain SilverBack V camera unit models, some of the secondary SDI connections can be re-assigned in the Settings menu to connect to a built-in internal viewfinder switch. The camera unit configurations that support a built-in viewfinder switch are shown in the table below.

Configuration	C3EO	C3GX	C2X2	C4K1	C4K2	C42R	C44R	C3X3
Viewfinder Switch	Yes	Yes	Yes	Yes	Yes	Yes	Yes	Yes

There are three types of 3G-SDI cards that can be installed in internal card slots: 2Tx, 2Rx, and TRx. Typically, a VF-capable card is installed in the slot closest to the Ethernet or audio connectors. VF mode port connections are highlighted in magenta on the label. Use the Video Settings menu to enable the viewfinder switch and choose the card slot to assign it to.

TRX Card	Viewfinder Mode Disabled		Viewfinder Mode Enabled	
BNC #	Port Name	Port Description	Port Name	Port Description
1	3G IN	3G-SDI video input	3G IN	3G-SDI video input
2	LOOP	Loop output of above input	3G OUT	Return video from the base unit
3	3G OUT A	Return video from the base unit	CAM IN	3G-SDI camera video input
4	3G OUT B	Return video from the base unit (copy)	VF OUT	Viewfinder switch output. Connect to SDI input of viewfinder monitor

2RX Card	Viewfinder Mode Disabled		Viewfinder Mode Enabled	
BNC #	Port Name	Port Description	Port Name	Port Description
1	3G OUT1 A	Return video 1 from the base unit	3G OUT1	Return video 1 from the base unit
2	3G OUT1 B	Return video 1 from the base unit (copy)	3G OUT2	Return video 2 from the base unit
3	3G OUT2 A	Return video 2 from the base unit	CAM IN	3G-SDI camera video input
4	3G OUT3 B	Return video 2 from the base unit (copy)	VF OUT	Viewfinder switch output. Connect to SDI input of viewfinder monitor

Ethernet Connection

The SilverBack V camera unit is equipped with a 10/100/1000 Mbps Ethernet port. Connect to the camera or other device using Cat 5e or Cat 6 cable.

Intercom Headset Connection

The SilverBack V camera unit is equipped with an intercom headset port supporting both single- and dual-muff intercom headsets via a 5-pin miniXLR connector. A 5-pin miniXLR-M to XLR-F adapter cable for dual-muff headsets is included with the system. Contact MultiDyne for other adapter cable options.

Audio Connections

There are two distinct audio connection sections on the SilverBack V camera unit. The first are the two miniXLR MIC/Line inputs adjacent to the intercom headset connector. These analog inputs are used for applications requiring MIC level or the flexibility of switching between MIC and Line level. These inputs are setup in the System menu. Gain is fixed at unity when set to Line mode. In MIC mode, gain is adjustable and 48V phantom power can be enabled. Two 3-pin miniXLR-M to XLR-F adapter cables are included with the system.

The other audio connector is a high-density 26-pin MDR connector. This provides bidirectional four-channel analog Line/AES connectivity, mimicking the DB25 on the base unit. These inputs and outputs are configured using the System menu as either analog Line level or AES, on a stereo-pair basis.

An MDR mating connector is included with each system for constructing breakout cables. See pinouts for more details. A pre-made breakout cable to XLR connectors is also available.

Part Number	Description
MDR-XLR-4X4AN-1M	Breakout cable, MDR26 to 4 XLR-F & 4 XLR-M

Tally and GPIO Connections

Tally and GPIO connections on the SilverBack V camera unit are provided on a high-density HD15 connector. The following table describes the available tally and GPIO signals.

Signal	Direction	Description	Pin
Red Tally	Output	Red tally relay contact. Will close to ground when activated.	
Green Tally	Output	Green tally relay contact. Will close to ground when activated.	
Generic GPI	Input	General-purpose GPI input. Connect to ground to activate.	
Generic GPO	Output	General-purpose relay contact. Will close to ground when activated.	
Viewfinder In Select	Input	Selects Viewfinder switch input source. Ground selects return video, open selects CAM input.	
Ch1 Intercom PTT	Input	Ch1 MIC enable trigger. Refer to Intercom Operation for more details.	
Ch2 Intercom PTT	Input	Ch2 MIC enable trigger. Refer to Intercom Operation for more details.	
Rec Trigger	Input	Reserved for future use.	
+12VDC	Output	+12VDC/1A max.	

An external tally light, as well as pre-made breakout cables, are available.

Part Number	Description
TL-SB5	SilverBack V camera-side tally light with 5-pin miniXLR connector
BO-TALLY-DB15-MXLR5	SilverBack V camera-side tally breakout cable, HD15 to 5-pin miniXLR
BO-PTT-TALLY-DB15	SilverBack V camera-side Y cable breakout supports tally and intercom push to talk. Includes two intercom PTT switches and 5-pin miniXLR.

Serial Data Connections

The SilverBack V camera unit is equipped with two dedicated user-configurable serial data ports to control cameras or other peripherals. Each data port can independently support RS232, RS422, LANC, and TTL level data. These two ports are combined into a single high-density HD15 connector. See pinouts for more details. Pre-made cables for specific camera and RCP manufacturers are available.

Part Number	Description
MDCAB00155-11	Cable Assembly, SilverBack V, camera-side RCP, for Sony 8-Pin. 11" long, HDB15 male to Hirose MXR Series 8-pin male
MDCAB00155-16	Cable Assembly, SilverBack V, camera-side RCP, for Sony 8-Pin. 16" long, HDB15 male to Hirose MXR Series 8-pin male
MDCAB00155-18	Cable Assembly, SilverBack V, camera-side RCP, for Sony 8-Pin. 18" long, HDB15 male to Hirose MXR Series 8-pin male
MDCAB00175	Cable Assembly, SilverBack V, camera-side RCP, for Panasonic 10-Pin. 16" long, HDB15 male to Hirose HR10A Series 10-pin male
MDCAB01255	Cable Assembly, SilverBack V, camera-side RCP, for Canon LANC, 16" long, HDB15 male to 2.5mm male plug
MDCAB01257	Cable Assembly, SilverBack V, camera-side RCP, for Sony FS9 LANC, 16" long, HDB15 male to 2.5mm male plug

D-Tap Power Connections

The SilverBack V camera unit is equipped with two D-Tap power output ports for powering external camera accessories. These outputs are 14VDC nominal (12-17VDC) and can each provide up to 5A.

CAMERA UNIT OPERATION

The control panel on the SilverBack V camera unit provides a simple interface that allows the camera operator to monitor system link and signal status using the SilverBack V display. Push buttons provide navigation assistance to reach menu options and to control intercom push-to-talk, headset volume, and viewfinder settings.

Control Panel Indicators and Controls

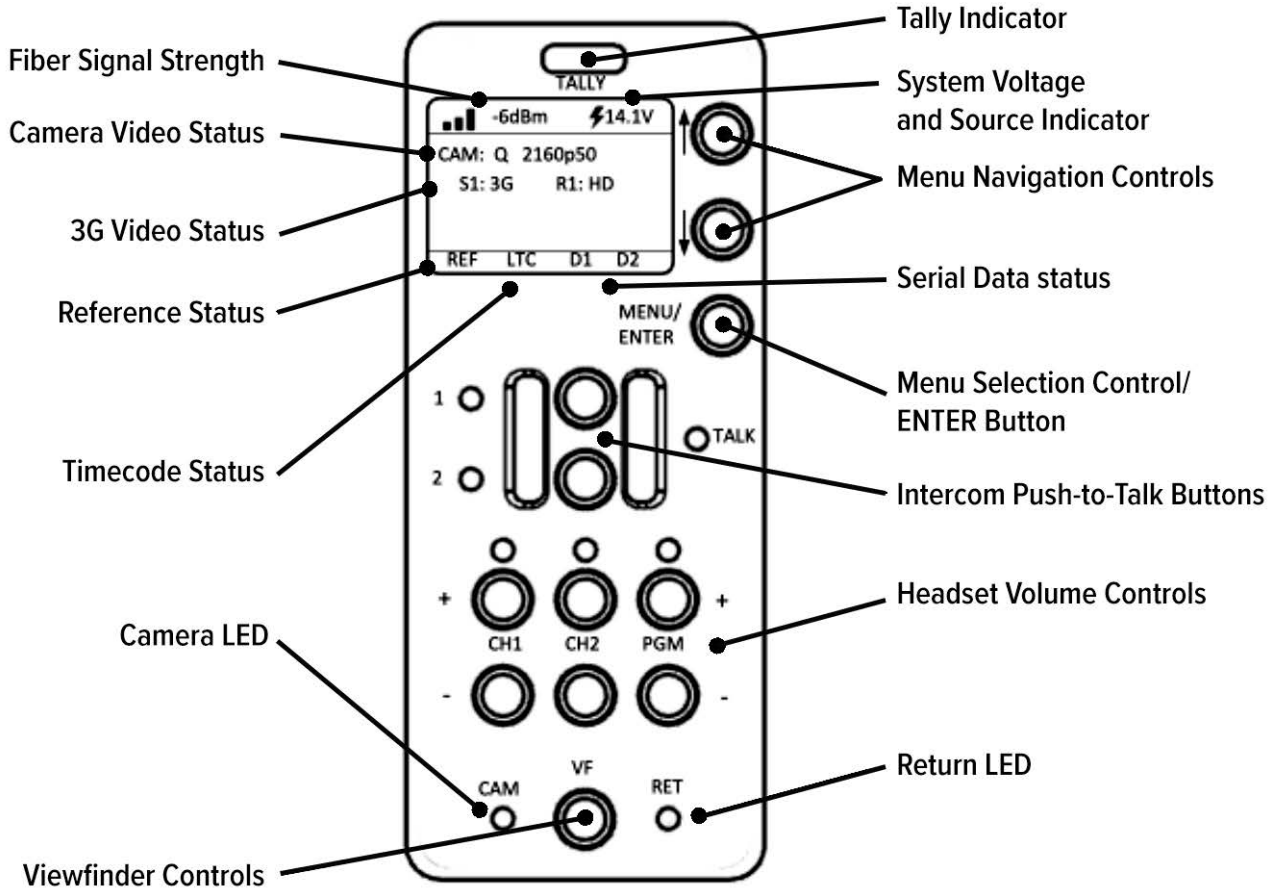

Control Panel Navigation

MENU/ENTER

- Press to open display main menu.
- Press again to select feature

UP/DOWN Arrow Buttons

- Use to navigate control panel Status pages and sub menus.

TALLY Indicator

- Illuminates when camera is live.

TALK 1 & 2

- TALK buttons provide momentary or latching PTT functionality for channels 1 and 2, either separately or simultaneously.

CH1, CH2 and PGM + or –

- Adjust intercom or program audio volume in the headset.
- LEDs indicate presence of intercom or program audio on each channel.

VF

- Determines which video signal is being sent to the viewfinder. This could be either the camera output or the return sent by the base unit.

CAM

- Illuminates when receiving camera output.

RET

- Illuminates when receiving base unit signal.

CONTROL PANEL: STATUS SCREENS

General Instructions

The display on the camera unit shows signal and system status on a series of Status pages. The various Status pages are accessed from the Home screen by pressing the UP/DOWN arrow buttons.

CAM Paired with SILVERBACK-VB

To use the camera unit with a SVB base unit, the base type configuration setting in the camera unit must be changed from the default SB5 setting to VB10. The setting will be remembered for subsequent power cycles so it only needs to be changed upon initial installation.

Menu Steps:

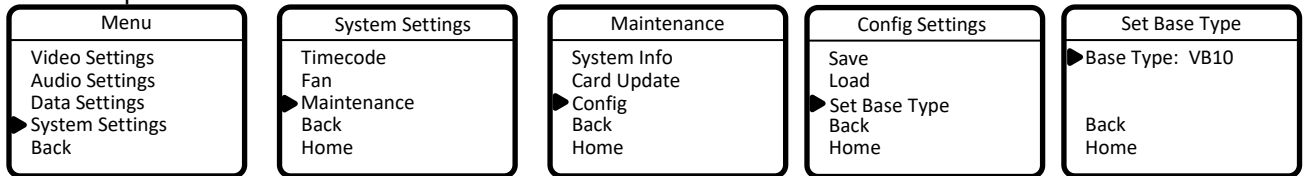

Status Screens

Home Screen

The Home status screen shows the most commonly needed system status information.

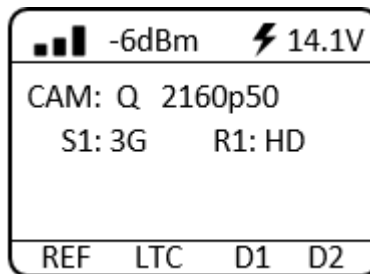

Fiber Link Status: Fiber Link status is shown both graphically as a series of bars and as an absolute signal strength reading. Fiber Link status is also color-coded green/yellow/red for easy assessment of the fiber signal strength.

System Voltage and Source Status: System output voltage to the camera is displayed, as well as whether the camera unit is operating on hybrid fiber power (lightning bolt) or from an external battery (battery symbol). Voltage and Source status are color-coded green/yellow/red for easy assessment of battery and camera voltage.

Camera Video Status: The video format being generated by the camera is shown on the line labeled CAM. For systems with an included 4K gearbox, the video resolution and frame rate will be displayed.

Secondary SDI Video Status: The video rate of the secondary SDI paths is shown here. Some systems may have more than one status line, depending on the number of included secondary SDI paths. Video sends from the camera unit (inputs) are shown with an “S” prefix. Video returns to the camera unit (outputs) are shown with an “R” prefix.

Reference Status: Reference Status (REF) will turn red when there is no reference sync signal connected at the base unit. REF will turn green when it has locked to the reference signal connected at the base unit. While the camera unit is locking to a reference signal, REF will turn yellow and display a countdown timer.

Timecode Status: Timecode status (LTC) will turn red when there is no timecode signal connected at the base unit. LTC will turn green when it has detected a timecode signal connected at the base unit.

Data Status D1, D2: D1 and D2 display data activity on the Data 1 and Data 2 serial ports. The indicator will turn green when data activity is detected.

Optical Status Screen

The Optical Status screen shows the optical receive and transmit power of the internal optics.

Optical Status	
1- Rx: -6.1	Tx: -1.2 dBm
2- Rx: -6.4	Tx: -2.6 dBm
3- Rx: -7.7	Tx: -2.0 dBm

Power Status Screen

The Power Status screen shows detailed system power information:

- **Batt Vin:** Displays the voltage of a connected battery.
- **Fiber Vout:** Displays the voltage being supplied by the hybrid fiber internal power converter.
- **Sys Vout:** Displays the system output voltage to the camera.
- **Power:** Displays the system power consumption in watts.
- **State:** Displays whether the system is operating from hybrid fiber power (Juice), battery, or Juice with battery backup.

Power Status	
Batt Vin:	0.0 V
Fiber Vout:	14.1 V
Sys Vout:	14.0 V
Power:	53.6 W
State:	Juice

CONTROL PANEL: CAMERA UNIT MENUS

General Instructions

All menus in the SilverBack V camera unit control panel function similarly. MENU/ENTER displays the Main menu.

Navigation within the menus:

- UP/DOWN arrows highlight menu options.
- MENU/ENTER toggles between or selects option.
- Select BACK and then ENTER to return to the previous menu.
- Select HOME and then ENTER to return to the main status screen.

Main Menu

The Main menu shows the setting options:

- Video Settings: Gearbox and viewfinder setup
- Audio Settings: Input, output, and intercom settings
- Data Settings: Data transmission settings
- System Settings: Timecode, fan, and maintenance settings

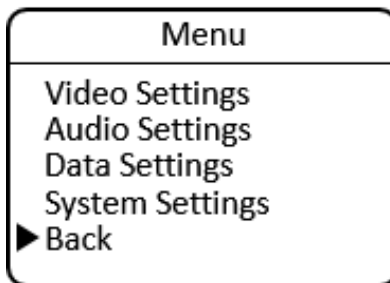

Video Settings

Gearbox Configuration and Operation

The gearbox in the SilverBack V camera unit takes the main camera video output and multiplexes it into a single video stream that is sent to the base unit. The gearbox accepts single-link, dual-link, and quad-link video inputs at SMPTE data rates ranging from 1.5G (HD) up to 12G.

The gearbox Input mode must be configured to match the type of output the camera is providing, which will be either a single-link, dual-link, or quad-link signal. The default setting from the factory is quad 3G.

Input Mode	Description
Single	The camera is outputting a single HD, 3G, 6G, or 12G stream.
Dual 3G	The camera is outputting a dual-link 3G stream (6G total).
Dual 6G	The camera is outputting a dual-link 6G stream (12G total).
Quad HD	The camera is outputting a quad-link HD stream (6G total).
Quad 3G (default)	The camera is outputting a quad-link 3G stream (12G total).

The gearbox relies on SMPTE S352M Program Identification (PID) metadata embedded in the camera’s output video stream to process the signal correctly. In some cases, this PID metadata may be missing or incorrect, which can cause incompatibility with the gearbox.

The PID mode setting is used to configure how the gearbox uses the PID metadata to multiplex the video into a single video stream. In most cases, the default setting of Auto should be used.

PID Mode	Description
Enable	Forces the gearbox to try to multiplex and convert a dual-link or quad-link signal into a visible SMPTE-compliant single-link 2SI (2 Sample Interleave) Level-A video stream with appropriate converted PID information.
Disable	Multiplexes a dual-link or quad-link signal into a single stream but maintains original PID information.
Auto (default)	Automatically determines PID conversion mode based on incoming PID information, number of links, and data rate.

The gearbox has certain limitations as to which dual-link and quad-link format inputs can be converted into a SMPTE-compliant 6G or 12G single-link 2SI Level-A video stream. The gearbox cannot convert Square Division (SD) format inputs into a 2SI format, nor can it convert Level-B format inputs to Level A. The gearbox can accept and transport SD and Level-A format inputs; however, they must be de-multiplexed in the gearbox in the base unit to their original format.

The gearbox is configured from the Video Settings menu.

MENU > Video Settings > Gearbox >

- In Mode: Select Single, Quad 3G, Quad HD, Dual 6G, or Dual 3G
- PID Mode: Select Auto, Enable, or Disable

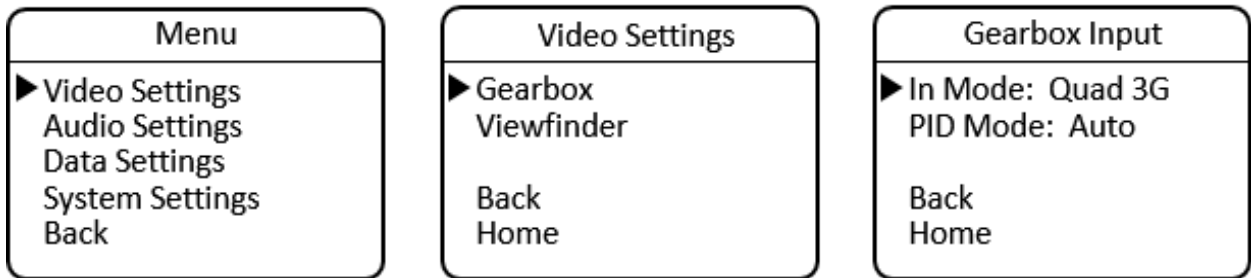

The Camera Gearbox may also be configured remotely, from the webpage dashboard accessed from the Base Unit.

Viewfinder Configuration and Operation

On certain SilverBack V camera unit models, some of the secondary SDI connections can be re-assigned in the Settings menu to connect to a built-in internal viewfinder switch. The camera unit configurations that support a built-in viewfinder switch are shown in the table below.

Configuration	C3EO	C3GX	C2X2	C4K1	C4K2	C42R	C44R	C3X3
Viewfinder Switch	YES	YES	YES	YES	YES	YES	YES	YES

Three types of 3G-SDI cards can be installed in internal card slots: 2Tx, 2Rx, and TRx. Typically, a VF-capable card is installed in the slot closest to the Ethernet or audio connectors.

The viewfinder is configured from the Viewfinder Setup menu under Video Settings.

MENU > Video Settings > Viewfinder >

- Enable: On or Off (default)
- Card Slot: 1-4 (available slots depend on the number and type of SDI cards installed)

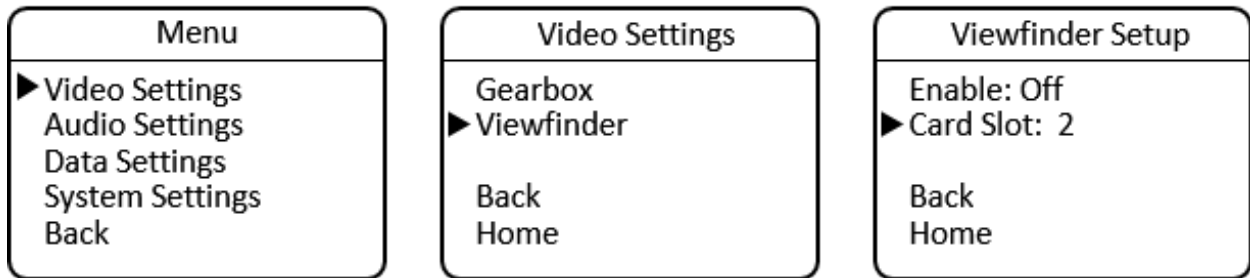

The Camera Viewfinder may also be configured remotely, from the webpage dashboard accessed from the Base Unit.

Audio Settings

SilverBack V camera unit audio input and output are configured in the Audio Settings menu.

MENU > Audio Settings

- Input
- Output
- Intercom

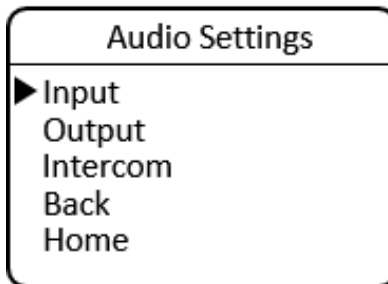

Audio Input Settings

The SilverBack V camera unit can accept analog line or MIC level inputs on the two miniXLR input connectors and/or analog Line or AES input on the high-density MDR connector. Audio input channels 1 and 2 can be taken either from the miniXLR connectors for MIC/Line applications or from the MDR connector for Line/AES applications. Audio input channels 3 and 4 are always from the MDR connector.

Audio Inputs 1 and 2, MIC or Line Mode, miniXLR Connectors

To configure the camera unit's inputs for audio channels 1 and 2 for MIC/Line mode, navigate to the Audio Inputs menu, select Input 1/2 Source, then XLR-MIC/Line.

MENU > Audio Settings > Audio Inputs > Input 1/2 Source > XLR-MIC/Line

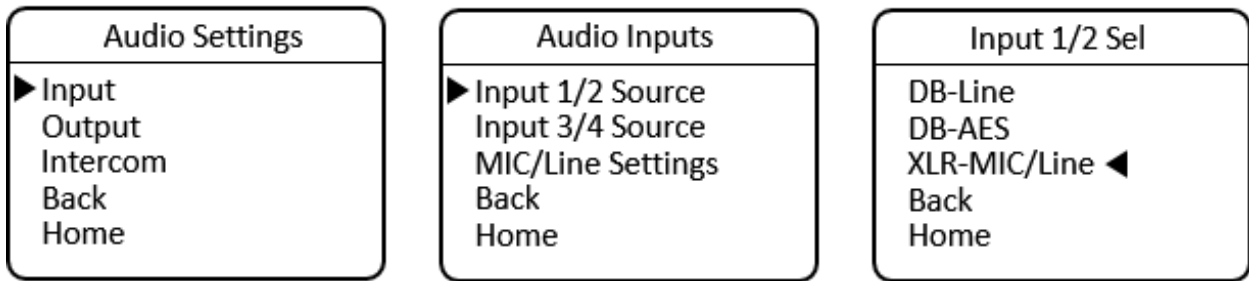

After setting the source, navigate back one level and select the MIC/Line Settings menu to configure each input.

MENU > Audio Settings > Audio Inputs > MIC/Line Settings

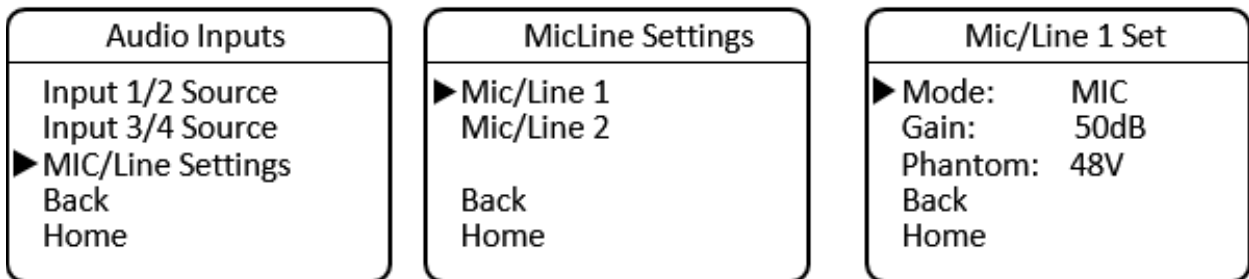

From here, the settings for each individual input are made. The settings for these two inputs are independent of each other; one may be set for MIC mode while the other is in Line mode, for example.

Navigate to the MIC/Line 1 Settings menu.

MENU > Audio Settings > Audio Inputs > MIC/Line Settings > MIC/Line 1 Settings

For Line mode, navigate to Mode and press Enter to toggle between MIC and Line modes until Line is displayed. After selecting Line for Input 1, navigate back up a menu level to configure input 2, if desired. When Line mode is selected, Phantom power is always turned off and Gain is fixed at 0 dB (unity).

For MIC mode, navigate to Mode and press Enter to toggle between MIC and Line modes until MIC is displayed. After selecting MIC for input 1, the previously used Gain and Phantom settings are recalled.

Navigate to Gain and press Enter to toggle through the available Gain settings. Gain is adjustable in 5dB increments. Navigate to Phantom and press Enter to turn Phantom power on or off, as desired. After completing the MIC settings for Input 1, navigate back up a menu level to configure Input 2, if desired.

Use the same procedure to configure Input 2 for Line or MIC mode by navigating to the MIC/Line 2 Settings menu.

MENU > Audio Settings > Audio Inputs > MIC/Line Settings > MIC/Line 2 Settings

Audio Inputs 1 and 2, Line or AES Mode, High-Density Connector

To configure the camera unit's inputs for audio channels 1 and 2 for Line or AES mode using the high-density connector, navigate to the Audio Inputs menu, select Input 1/2 Source, then select either DB-Line or DB-AES, as desired. These inputs are treated as a stereo pair together and cannot be split between analog and AES.

MENU > Audio Settings > Audio Inputs > Input 1/2 Source > DB-Line

or

MENU > Audio Settings > Audio Inputs > Input 1/2 Source > DB-AES

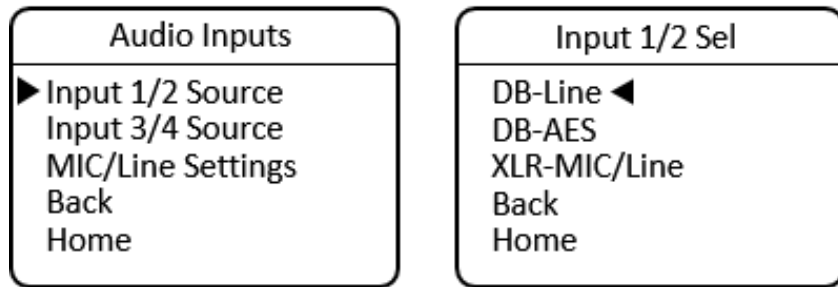

When selecting AES for inputs 1 and 2, the input is taken from the channel 1 input. After setting the source, navigate back one level to configure the settings for input 3 and 4.

Audio Inputs 3 and 4, Line or AES Mode, High-Density Connector:

To configure the camera unit's inputs for audio channels 3 and 4 for Line or AES mode using the high-density connector, navigate to the Audio Inputs menu, select Input 3/4 Source, then select either DB-Line or DB-AES, as desired. These inputs are treated as a stereo pair and cannot be split between analog and AES. They may be set differently than inputs 1 and 2, however.

MENU > Audio Settings > Audio Inputs > Input 3/4 Source > DB-Line

or

MENU > Audio Settings > Audio Inputs > Input 3/4 Source > DB-AES

When selecting DB-AES for inputs 3 and 4, the input is taken from the channel 3 input.

Audio Output Settings

The SilverBack V camera unit outputs four channels of analog Line-level or AES audio on the high-density MDR connector.

Audio Outputs 1 and 2, Line or AES Mode, High-Density Connector

To configure the camera unit’s outputs for audio channels 1 and 2 for Line or AES mode using the high-density connector, navigate to the Audio Outputs menu, select Out 1/2 Type, then select either DB-Line or DB-AES, as desired. These outputs are treated as a stereo pair and cannot be split between analog and AES.

MENU > Audio Settings > Audio Outputs > Out 1/2 Type > DB-Line

or

MENU > Audio Settings > Audio Outputs > Out 1/2 Type > DB-AES

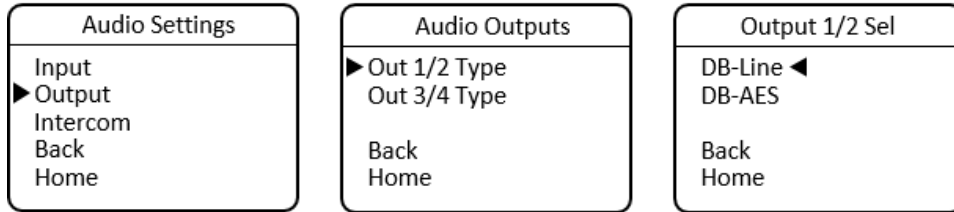

When selecting AES for outputs 1 and 2, the output is taken from channel 1. After setting outputs for channels 1 and 2, navigate back one level to configure the output settings for channel 3 and 4.

Audio Outputs 3 and 4, Line or AES Mode, High-Density Connector

To configure the camera unit’s outputs for audio channels 3 and 4 for Line or AES mode using the high-density connector, navigate to the Audio Outputs menu, select Out 3/4 Type, then select either DB-Line or DB-AES, as desired. These outputs are treated as a stereo pair and cannot be split between analog and AES.

MENU > Audio Settings > Output > Out 3/4 Type > DB-Line

or

MENU > Audio Settings > Output > Out 3/4 Type > DB-AES

When selecting AES for outputs 3 and 4, the output is taken from the channel 3 output.

The Camera Unit audio settings may also be configured remotely, from the webpage dashboard accessed from the Base Unit.

Intercom

The SilverBack V camera unit uses a 5-pin miniXLR connector to allow use of either single-muff or dual-muff intercom headsets. Headset MIC Gain and Sidetone settings are adjusted from within the Intercom Settings menu. Volume and talkback control are provided using dedicated buttons on the control panel for quick access.

Intercom Settings

To configure headset MIC Gain, navigate to the Audio Settings menu, select Intercom, and then select MIC Gain. Press Enter to toggle through the available Gain settings and stop at the desired setting.

MENU > Audio Settings > Intercom Settings > MIC Gain

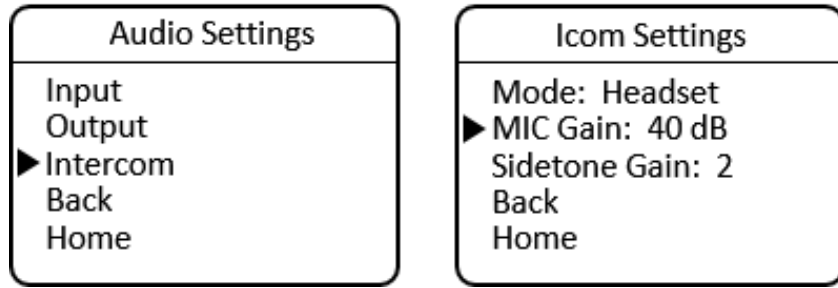

To configure headset Sidetone Gain, navigate to the Audio Settings menu, select Intercom, then select Sidetone Gain. Press Enter to toggle through the available Gain settings and stop at the desired setting.

MENU > Audio Settings > Intercom > Sidetone Gain

The Camera Intercom settings may also be configured remotely, from the webpage dashboard accessed from the Base Unit.

Intercom Operation

Volume controls are provided on the camera unit control panel for adjusting the audio levels of Intercom 1 (CH1), Intercom 2 (CH2), and Program (PGM) audio heard in the headset. The volume controls allow both intercom channels and program audio to be heard in the headset simultaneously.

A LED above each channel's set of volume control buttons will illuminate whenever audio is present on that channel. When adjusting the volume, these LEDs will rapidly blink three times whenever the minimum or maximum volume setting has been reached.

Two push-to-talk (PTT) switches are provided on the camera unit control panel, one for each intercom channel. Each PTT switch provides Momentary or Latching operation of the headset microphone to allow the operator to talk on a particular intercom channel, or on both channels simultaneously.

To talk on an intercom channel using Momentary mode:

1. For the desired channel, channel 1 or 2, press and hold the desired PTT switch, then speak into the microphone.
2. The TALK LED and selected channel TALK LED will blink and the microphone will remain open while the PTT switch is held.
3. When finished with the conversation, release the PTT button.
4. The microphone will shut off and the TALK LEDs will turn off.

To talk on an intercom channel using Latching mode for longer-term hands-free operation:

1. Quickly press and release the PTT switch for channel 1 or channel 2.
2. The microphone will latch open and TALK LED and the selected channel TALK LED will blink continuously.
3. When finished with the conversation, quickly press and release the PTT switch again.
4. The microphone will shut off and the TALK LEDs will turn off.

To talk on both intercom channels simultaneously (latching Mode only):

1. Quickly press and release the PTT switch for channel 1.
2. The microphone will latch open and the TALK and Ch1 TALK LEDs will blink continuously.
3. Quickly press and release the PTT switch for channel 2.
4. The microphone will stay open and the Ch2 TALK LED will now also blink continuously.
5. When finished with the conversation, quickly press and release the PTT 1 switch again to shut off channel 1 and then repeat for channel 2.
6. The microphone will shut off and the TALK LEDs will turn off.

Serial Data Settings

The SilverBack V camera unit's Serial Data Channel settings are configured in the Data Settings Menu. Each data port can be configured for RS232/RS422 type data or LANC control data. The factory default setting is RS232/422.

To configure a data channel, navigate to the Main menu and select Data Settings. Move to the Data 1 selection line and press Enter to toggle through the available settings. Then move to the Data 2 selection line and press Enter to toggle through the available settings.

MENU > Data Settings >

- Data 1: 232/422 or LANC
- Data 2: 232/422 or LANC



The Camera serial data settings may also be configured remotely, from the webpage dashboard accessed from the Base Unit.

System Settings

The System Settings menu provides system information and allows control of some overall system functions.

Timecode Settings

The SilverBack V camera unit has a single HDBNC connector for timecode transport. This connector can be set as an input or an output, depending on the desired workflow. The factory default setting is Output.

Timecode direction settings are found under the System menu. Navigate to the Main menu, select

System Settings, and from the System Settings menu select Timecode. On the Timecode BNC menu, select Direction and press Enter to toggle through the available settings.

The Camera timecode settings may also be configured remotely, from the webpage dashboard accessed from the Base Unit.

MENU > System Settings > Timecode BNC

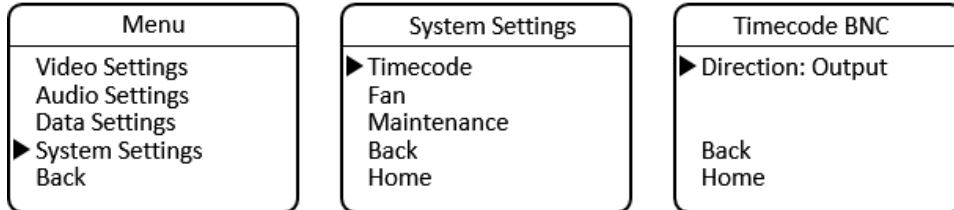

Some cameras utilize only a single connector for timecode. In this case, please ensure the timecode port direction on the camera is also set accordingly.

Fan Control

To change the speed of the internal fan, navigate to the Main menu, select System Settings, then Fan. The Profile is a factory setting and should be kept at the default setting of 1. For fan speed, the choices are Off, Low, Med, and High. It is recommended to keep the speed setting at high to ensure maximum cooling.

MENU > System Settings > Fan Settings

- Profile: 1 to 4
- Speed: Low, Medium, High, or Off

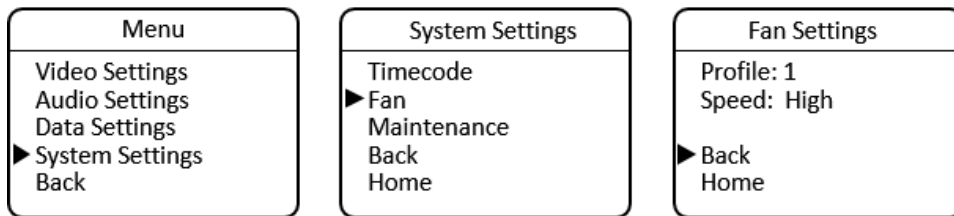

The Camera fan settings may also be configured remotely, from the webpage dashboard accessed from the Base Unit.

System Information

The System Info menu displays the software versions of the unit, as well as provides control of the brightness of the OLED display and LEDs on the control panel.

MENU > System Settings > Maintenance > System Info

- Software: Version number
- FPGA: Version number
- Brightness: Select 1 to 5

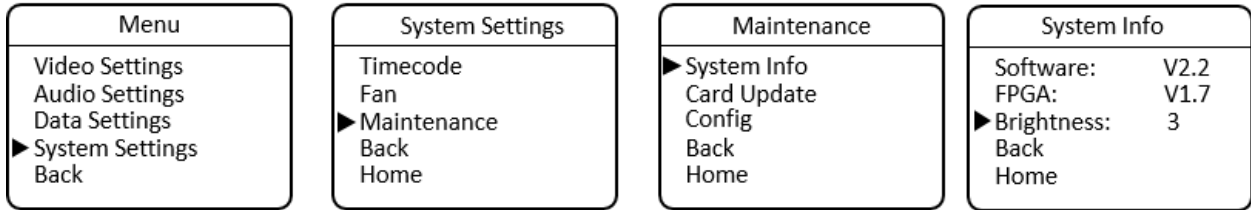

Card Update

To update system software from a MicroSD card installed in the side of the control panel, navigate to the Main menu, select System Settings, then Maintenance, then Card Update. Camera Unit software can also be updated remotely from the Base Unit. See Appendix C for more details.

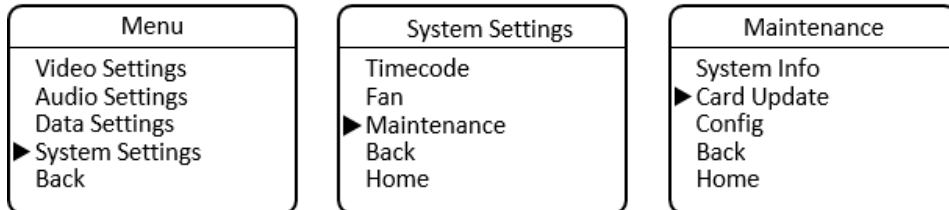

Saving and Recalling Settings

Camera Unit configuration settings can be saved to a microSD card for easy recall or to share between camera units. The Configuration Load/Save Menu is accessed from the Maintenance Menu.

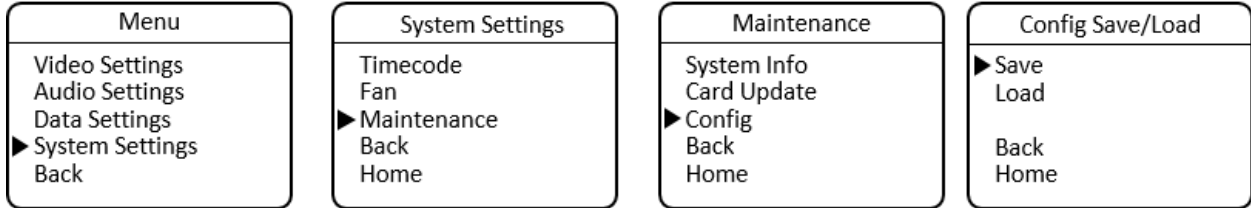

Note: In order to use the configuration save/recall feature, the microSD card must have a valid, existing config.txt file on it. This file may be obtained from MultiDyne service or can be created on the Base Unit microSD card and then copied to another card for use in the camera unit (see below).

Camera Unit configuration settings may also be saved or recalled, remotely, from the webpage dashboard that is accessed via the Base Station. Navigate to the Camera Configuration Load/Save Settings Box on the webpage and then click the Load or Save button as desired. Configuration will be saved to the microSD card in the Base Unit

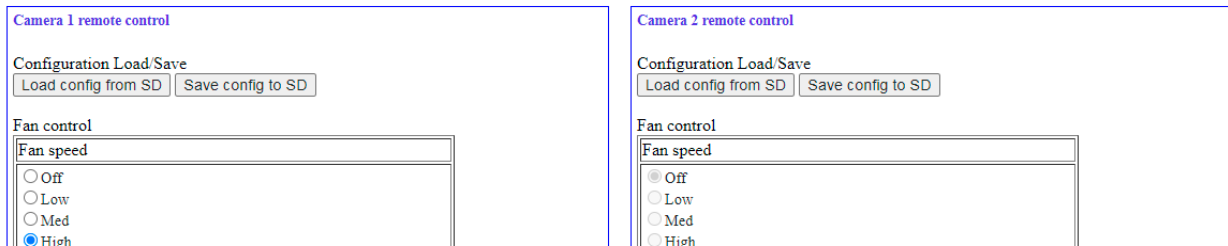

BASE UNIT OPERATION

The front panel on the SilverBack V base unit provides a simple interface that allows operators to monitor system link and signal status using LEDs and a TFT display. A joystick provides navigation assistance to reach menu options for further status and system configuration.

Front Panel Indicators and Controls

Control Panel Layout



BASE UNIT MENUS

General Instructions

All menus in the SilverBack V base unit control panel function similarly:

- NAV multidirectional actuator (joystick) allows you to move through the menus.
- Press in the center to select.

When in the menus:

- Select BACK to return to the previous menu.
- Select HOME to return to the main menu.

SBV System Status

The Home screen on the base unit displays a quick overview of SilverBack V system status.

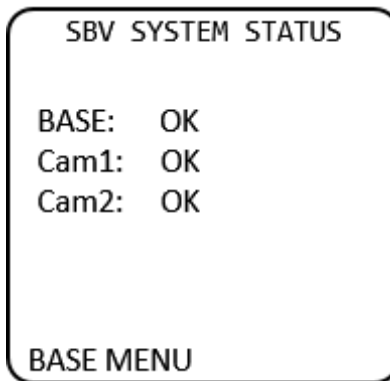

Base Unit Root Menu

- Status: Fiber/Video/Audio/Intercom/Power
- Settings: Audio Input/Audio Output/Video/Intercom/Reference/Data
- Network
- Maintenance

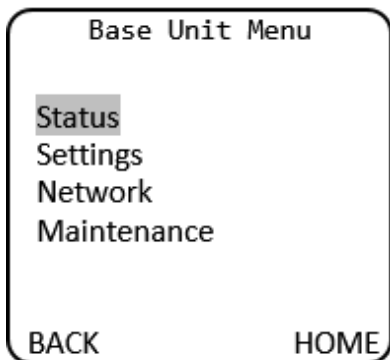

The Base Fiber Rx Status menu displays GBX, 3G or COR for video channels 1 and 2 depending on the cards installed.

Base Unit Menu > Status > Fiber > Base Fiber Rx Status

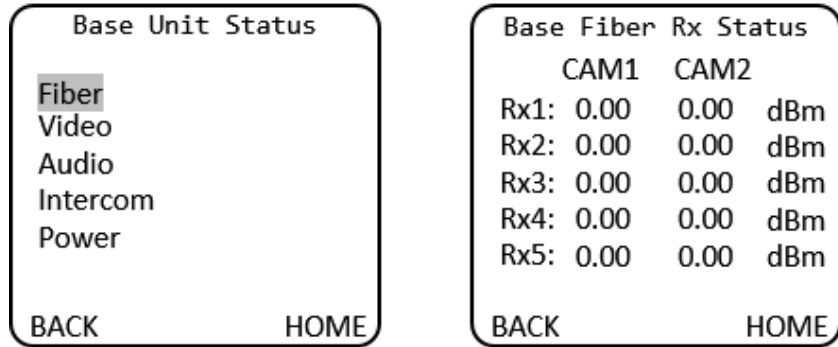

The Base Video Status menu displays video resolution for video channels 1 and 2 depending on the cards installed.

Base Unit Menu > Status > Video > Base Video Status

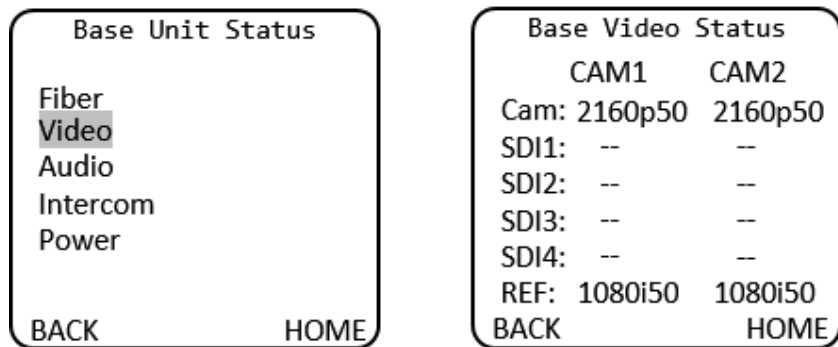

Base Unit Menu > Status > Audio > Base Audio Status

The Base Audio Status menu displays "OK" if there is audio on each respective audio channel.

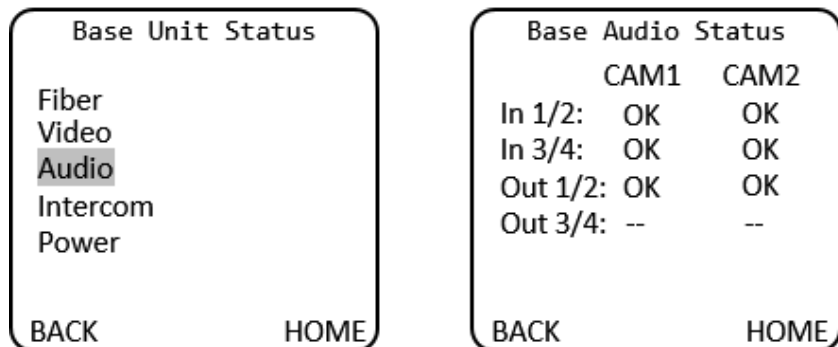

Base Unit Menu > Status > Intercom > Base Intercom Status

The Base Intercom Status menu displays “OK” if there is audio on each respective audio channel.

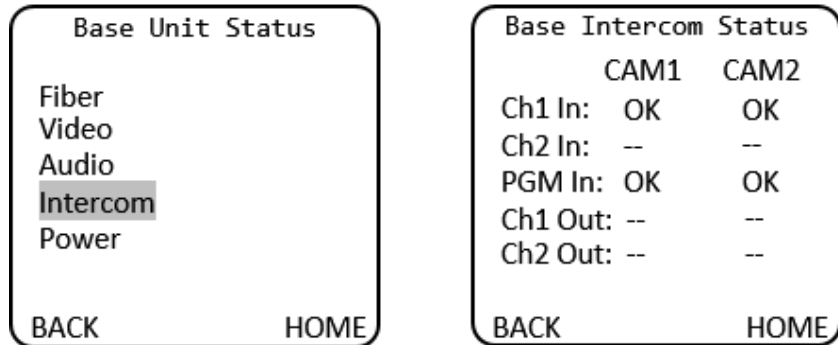

Base Unit Menu > Status > Power > Base Power Status

The Base Power Status menu displays Volts and Amps settings for each power supply unit.

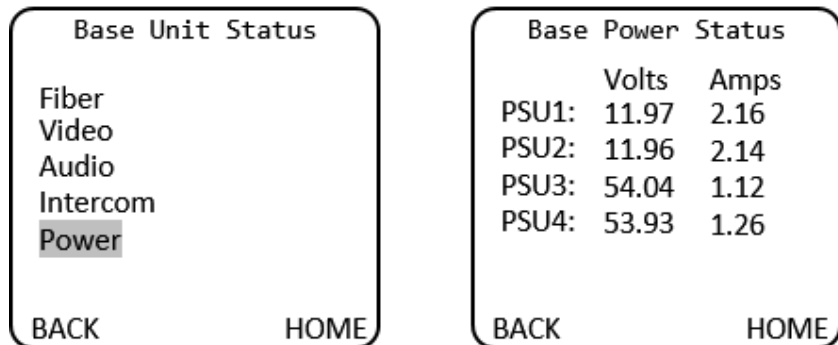

Base unit settings for Audio Input/Audio Output/Video/Intercom/Reference/Data are accessed via the Base Unit Settings menu.

Base Unit Menu > Settings

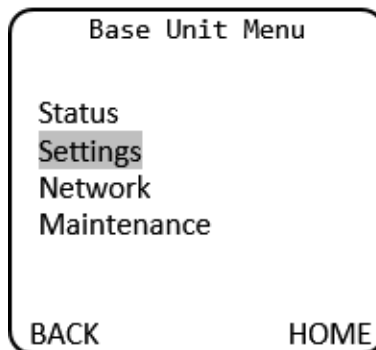

Gearbox Configuration and Operation

The gearbox in each camera chain in the SilverBack V base unit receives the main camera video stream from the camera unit and de-multiplexes it back into its original video format.

The gearbox mode must be configured to match the type of output the camera is providing, which will be either a single-link, dual-link, or quad-link signal. The default setting from the factory is Quad 3G.

Output Mode	Description
Single Link	The base unit outputs a single HD, 3G, 6G or 12G stream.
Dual Link 3G	The base unit outputs a dual-link 3G stream (6G total).
Dual Link 6G	The base unit outputs a dual-link 6G stream (12G total).
Quad Link HD	The base unit outputs a quad-link HD stream (6G total).
Quad Link 3G (default)	The base unit outputs a quad-link 3G stream (12G total).

The gearbox relies on SMPTE S352M PID metadata embedded in the camera's output video stream to process the signal correctly. In some cases, PID metadata from the camera may be missing or incorrect, which can cause incompatibility with the gearbox.

The PID Mode setting is used to configure how the gearbox processes the PID metadata from the camera. In most cases, the default setting of Auto should be used.

Auto PID Mode	Description
Enable (default)	Automatically determine video format conversion and PID conversion modes based on incoming PID information and Output mode setting.
Disable	The gearbox will output video using the selected Output mode, but will maintain original PID information from the camera.

The gearbox has certain limitations as to which camera video formats can be converted between single-link, dual-link, and quad-link video streams. The gearbox cannot convert Square Division (SD) camera formats into a 2SI formats, nor can it convert Level-B formats to Level A. Only 2SI Level-A camera video streams are capable of being converted between single-link, dual-link, and quad-link. The gearbox can accept and transport SD and Level-A camera formats; however, they must always be de-multiplexed in the gearbox in the base unit back to their original format.

The gearbox for each camera chain is configured from the Video Settings menu:

Base Unit Menu > Settings > Video > Base Video Settings

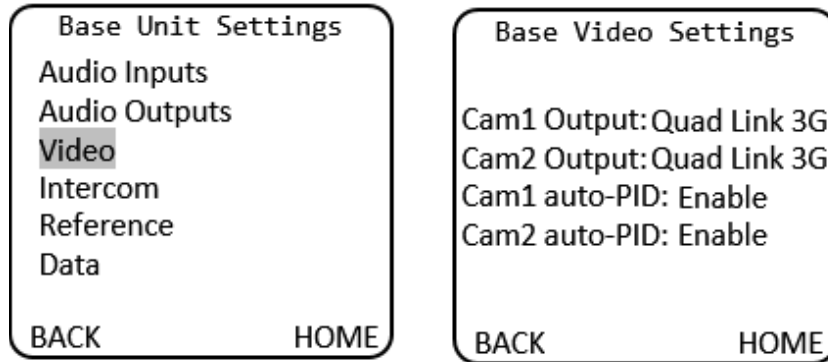

The Gearbox settings may also be configured from the webpage dashboard accessed from the Base Unit.

Audio Input Configuration

The SilverBack V base unit can accept analog Line-level or AES inputs on the DB25 connector.

To configure the base unit audio inputs for Line or AES mode, navigate to the Base Unit Settings menu and select Audio Inputs, then either Analog or AES as desired for each camera chain. Audio inputs are treated as stereo pairs for channels 1 and 2 and channels 3 and 4. When selecting AES for either input pair, the physical input is taken from the odd numbered input channel on the connector.

Base Unit Menu > Base Unit Settings > Audio Input Settings

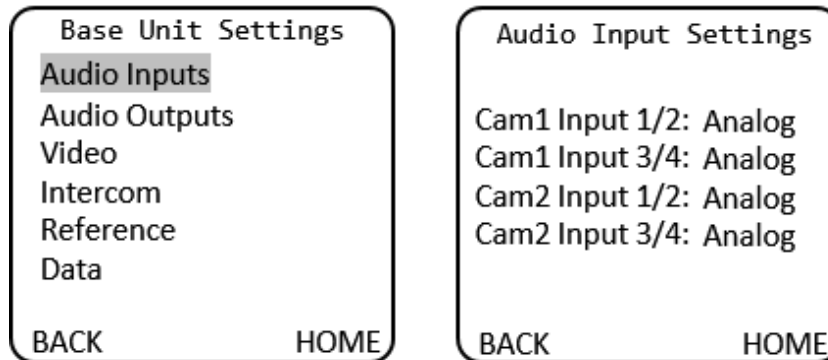

The Audio input settings may also be configured from the webpage dashboard accessed from the Base Unit.

Audio Output Configuration

The SilverBack V base unit can output analog Line-level or AES audio on the audio DB25 connector.

To configure the base unit audio outputs for Line or AES mode, navigate to the Audio Output Settings Menu and select either Analog or AES as desired for each camera chain. Audio outputs are treated as stereo pairs for channels 1 and 2 and channels 3 and 4.

To configure the base unit audio outputs for Line or AES mode, navigate to the Base Unit Settings menu and select Audio Outputs, then either Analog or AES for each camera chain. Audio outputs are treated as stereo pairs for channels 1 and 2 and channels 3 and 4. When selecting AES for either output pair, the physical output is taken from the odd numbered output channel on the connector.

Base Unit Menu > Settings > Audio Outputs >

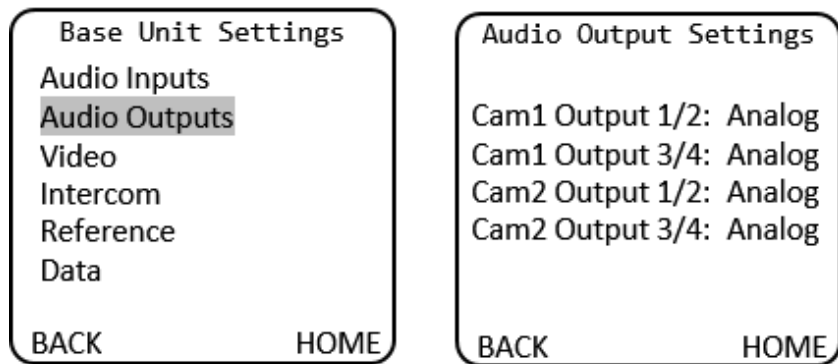

The Audio output settings may also be configured from the webpage dashboard accessed from the Base Unit.

Intercom Configuration

The SilverBack V base unit can interface with either 4-wire or 2-wire party-line intercom systems using the intercom/GPIO DB25 connector.

To configure the base unit intercom interface for 4-wire or 2-wire mode, navigate to the Base Unit Settings menu and select Intercom, then either 4-wire or 2-wire. Both camera chains in the base unit share the same interface type automatically.

Base Unit Menu > Base Unit Settings > Base Intercom Settings

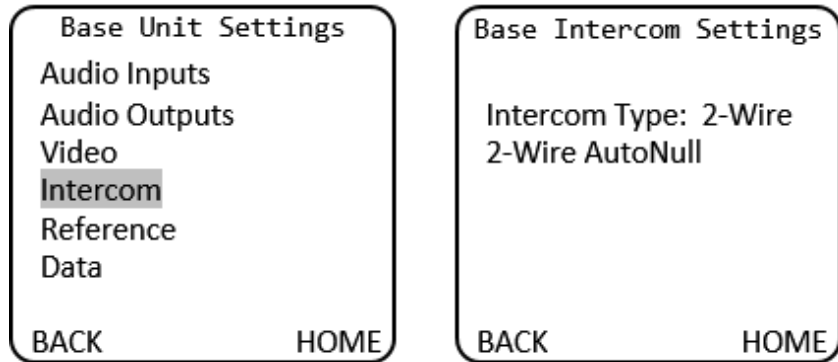

For 2-wire intercom systems, it is recommended that an AutoNull be performed whenever any device is physically added or removed from the 2-wire party line. To AutoNull any of the 2-wire intercom channels, select the 2-wire AutoNull menu and click on the desired channel to be nulled. The AutoNull process takes about 30 seconds to complete for each channel while a series of tones are transmitted on that party line.

Base Unit Menu > Base Unit Settings > Base Intercom Settings > 2-Wire AutoNull

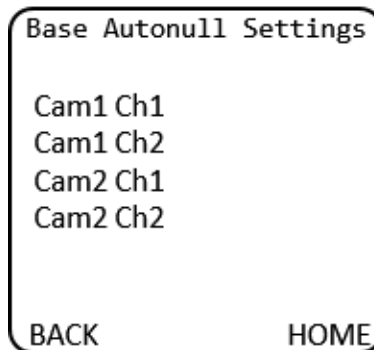

The Intercom settings may also be configured from the webpage dashboard accessed from the Base Unit.

Reference and Timecode Configuration

Each camera chain in the SilverBack V base unit has dedicated reference sync and timecode inputs. For dual camera chain systems, either chain's reference or timecode input may be internally routed to either or both of the camera chains.

To configure the base unit reference and timecode settings, navigate to the Base Unit Settings menu and select Reference, then select the desired REF and LTC input for each camera chain.

Base Unit Menu > Base Unit Settings > Base Reference Settings

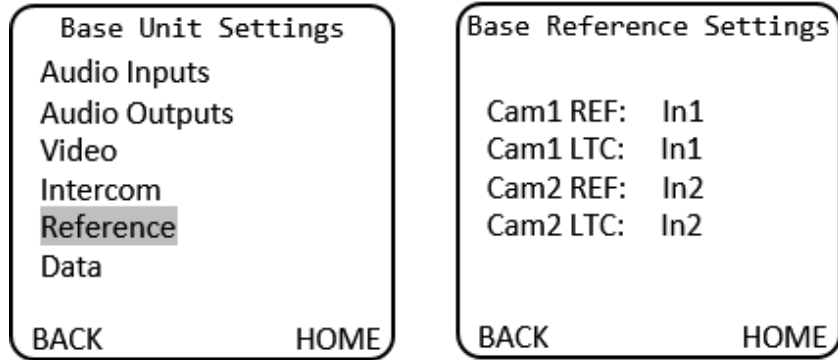

The reference and timecode routing settings may also be configured from the webpage dashboard accessed from the Base Unit.

Serial Data Configuration

SilverBack V base unit Serial Data Channel settings are configured in the Data Settings menu. Each data port can be configured for RS232/RS422 type data or LANC control data. The factory default settings are RS232/422.

To configure a data channel, navigate to the Base Unit Settings menu and select Data, then select the desired data types for the camera and data ports of each camera chain.

Base Unit Menu > Base Unit Settings > Base Data Settings

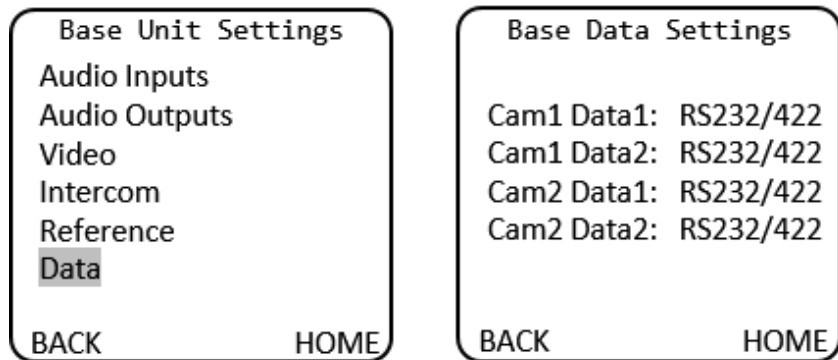

The serial data settings may also be configured from the webpage dashboard accessed from the Base Unit.

Base Unit Network Configuration

The SilverBack V base unit can monitor the Status and Control settings of the system through a web-based dashboard embedded within the frame controller software. The procedure for connecting to a facility Ethernet network will depend on the network requirements of the site. Your IT department should be contacted before connecting to the facility network to avoid potential conflicts.

To display the current network settings of the frame controller card, navigate to the Base Unit menu on the front panel display and select Network. No settings can be changed from the Base Network Settings menu, as they are configured either from the DIP switch accessible from the rear of the unit or from the dashboard web page.

Base Unit Menu > Base Network Settings

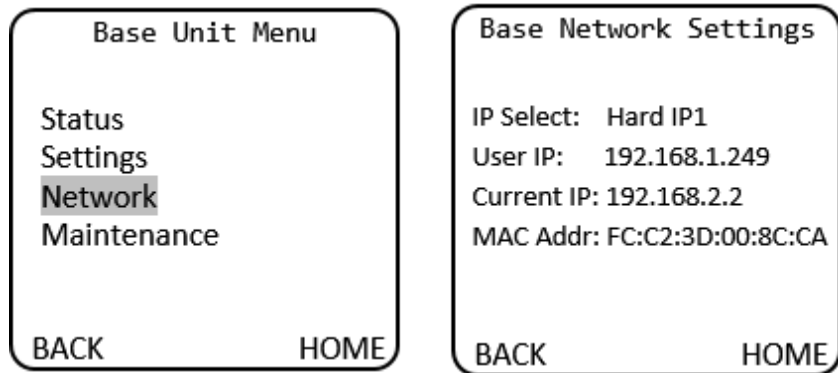

IP Address Settings

Four DIP switches on the rear of the SilverBack V chassis are used to set the network address. (Note: Only one switch can be set to the ON position.)

DIP Switch #	Description
1	DHCP. Network settings assigned by a DHCP server.
2	User IP Address. IP address is set by the user through embedded web page. Factory default is 192.168.1.249.
3	Fixed IP Address #1. 192.168.2.2.
4	Fixed IP Address #2. 10.1.1.2

DHCP (DIP Switch 1)

Configures the SilverBack V base unit with an automatically assigned IP address. To configure the network settings via DHCP:

- Using an Ethernet cable, connect the SilverBack V base unit to your network.
- Power up the SilverBack V base unit.
- Set the DIP switch #1 to ON to specify DHCP configured settings.

Preset IP Address (DIP Switch 3 or 4)

Set the DIP switch to specify the desired preset IP address (as outlined in the IP address DIP switch table). Ensure that your computer and the SilverBack V base unit are on the same subnet. Contact your IT department if you need help determining or configuring the network settings of your computer.

To prevent possible IP address conflicts:

- Initially isolate the SilverBack V base unit and your computer from the rest of your network by unplugging all devices except the SilverBack V base unit and your computer.

or

- Use an Ethernet cable to connect the SilverBack V base unit directly to your computer.

From your computer, launch a web browser.

- Power up the SilverBack V base unit.
- In the address bar of the web browser, enter the preset IP address indicated on the DIP switch.
- Wait approximately 30 seconds while network communications are established.
- Verify that the SilverBack V base unit dashboard web page displays in the web browser.
- Should the web page fail to display after a minute or two:
 - Click the refresh/reload button in your browser.
 - Verify that the Ethernet cables are properly connected.
 - Ensure that the LEDs on the Ethernet connector registers activity.
 - Verify that you have properly performed each step of this procedure.
- If you and your IT team cannot establish a connection, contact MultiDyne Technical Support.

Custom User IP Address (DIP Switch 2)

With network communications established, you may wish to configure a custom static IP address through the Frame Ethernet Settings box on the web page dashboard.

- Establish communications with the SilverBack V base unit by using one of the preset IP addresses, DHCP, or previously configured User IP address.
- From your computer, launch a web browser and enter the previously established IP address.
- When the dashboard launches, enter the desired user IP address in the Frame Ethernet Settings box. (Ensure that your computer and the SilverBack V base unit are on the same subnet. Contact your IT Department if you need help determining or configuring the network settings of your computer.)
- Verify the IP address. Click "Save IP". (The IP address is stored in non-volatile memory.)
- Switch the DIP switch #2 to ON. (If this switch is already on, you may need to toggle for the address to take effect.)
- Verify the new IP address by entering it into a web browser address bar.

The screenshot shows a web page titled "Frame Ethernet Settings" with a blue border. It displays the following information and controls:

- MAC Address: FC:C2:3D:0:8C:CA
- Current IP Address: 192.168.1.249
- IP Switch Setting: User IP
- User IP Address: Four input fields containing "192", "168", "1", and "249", followed by a "Save IP" button.
- Frame Description: An input field containing "Rack 12 Top" and a "Save Info" button.
- Frame ID Led: A "Turn On" button.

PRO TIP: Physically Identifying a SilverBack V Base Unit in a Facility

A LED on the rear of the frame controller card in the chassis can assist in identifying a SilverBack V base unit amidst other rack-mounted gear. Turn this LED on or off from the Frame Ethernet Settings box on the web page. The LED blinks when turned on.

Firmware Updates

Base Unit Menu > Base Maintenance Menu

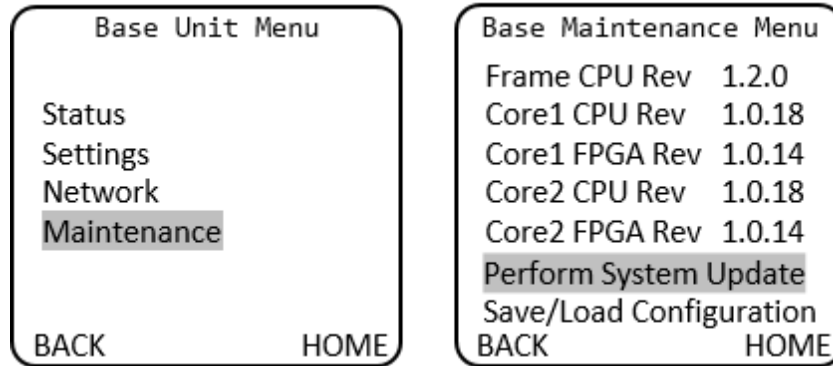

See the procedure for updating SilverBack V firmware in Appendix C of this manual. Software may also be updated using the system webpage dashboard.

Base Unit Menu > Base Maintenance Menu > Perform System Update

- FW Name: Firmware to be flashed
- FW Size: Size in Bytes
- Update: Cam1 or Update Cam2

Saving and Recalling Settings

Base Unit configuration settings can be saved to the microSD card for easy recall or to share between base units. The Configuration Load/Save Menu is accessed from the Maintenance Menu.

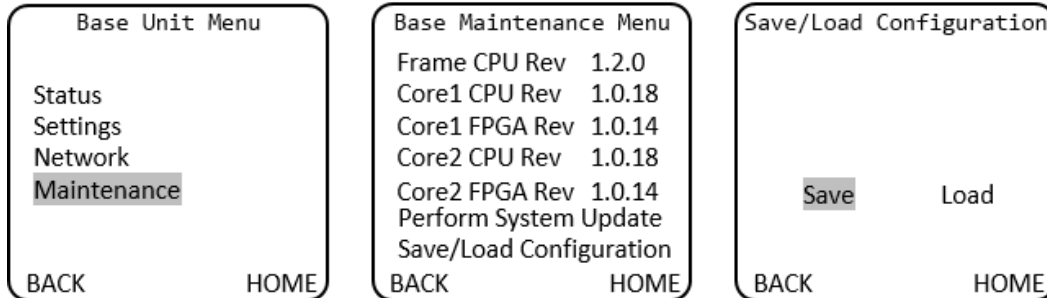

Configuration settings may also be saved or recalled from the webpage dashboard. Navigate to the Base Configuration Load/Save Settings Box on the webpage and then click the Load or Save button as desired.

Base Configuration Load/Save

Load config from SD

Save config to SD

SILVERBACK-VB

The camera end must be configured for use with the SILVERBACK-VB base. See [CAMERA UNIT OPERATION](#) for details.

The SilverBack-VB system is engineered to bring a lower cost and smaller footprint solution to a wider range of camera platforms and applications. The SilverBack-VB provides a robust, full bandwidth fiber optic link between any 12G 4K or HD camera and your truck, control room, or “video village” position. The system puts all the signals needed for multi-camera 4K/UHDTV production onto a single tactical or SMPTE hybrid fiber cable, ensuring robust, trouble-free connectivity on any studio or remote production. Full camera control is provided by the camera manufacturer’s control panel via serial or a 10/100/GigE Ethernet path. Genlock, Intercom, Tally and GPIO are also provided. Pair with the JUICE-48 power supply and operate on a hybrid cable and provide power to the camera or use lightweight, robust tactical fiber and power the camera locally for the lowest cost solution.

The Silver-back-VB system uses a 1RU half rack width enclosure reducing rack space requirements and shipping costs for flypacks and rentals. Status LEDs on the front panel provide peace of mind that signals are flowing.

Sample Base



VB Base Breakout Cables

Model	Cable Part #	Description
VB	CA-HD15M2DE9-GPIO-1M	RS-232/422 Data/Tally/GPIO Breakout Y-Cable SB-VB, 1-Meter HD15m to 2 x DE9 (female) & Bare Wire GPIO / Tally
V/VB	MDCAB00160	Sony / Canon RCP data cable for SilverBack-V/B base station, 10', 8 Pin Hirose to DB-9
V/VB	MDCAB00180	Panasonic RCP data cable for SilverBack base station, 10 feet, 10 Pin Hirose to DB-9 data connector
V/VB	MDCAB01068	Canon RCP data cable for SilverBack-V/B base station, 10', DB9 Male to 3.5mm
V/VB	MDCAB01256	Base Station LANC Remote Cable 10' for Sony - 9-Pin to 2.5mm
V/VB	MDCAB01257	Base Station LANC Remote Cable 10' for Canon - 9-Pin to 3.5mm
V/VB	MDR-XLR-4X4AN-18I	18 Inch XLR Breakout for 4 x 4 Analog Audio. MDR Connector to 4 XLR male & 4 XLR female

V/VB	MDR-XLR-4X4AN-1M	1 Meter XLR Breakout for 4 x 4 Analog Audio. MDR Connector to 4 XLR male & 4 XLR female
------	------------------	---

Audio & Intercom Pinout

The VB Audio and Intercom Cards transport 4x4 balanced analog audio channels, with a max level of +4 dBu.

*Note the same **MDR-XLR-4X4AN-xx** style cables can be used on either camera and VB base ends.

The connector (PN 1026-3000PE) is a 26-Position cable receptacle connector.

MDR PIN #	VB FUNCTION	XLR (FEMALE)	SB5 CAM FUNCTION (INTERCOM)	SB5 CAM FUNCTION (AUDIO MDR)
1	GND	XLR 1_PIN 1	I-COM 1	GND
2	AUD1_IN-	XLR 1_PIN 3		AUD1_OUT-
3	AUD1_IN+	XLR 1_PIN 2		AUD1_OUT+
4	GND	XLR 2_PIN 1	I-COM 2	GND
5	AUD2_IN+	XLR 2_PIN 2		AUD2_OUT+
6	AUD2_IN-	XLR 2_PIN 3		AUD2_OUT-
7	GND	XLR 3_PIN 1	PROG. 1	GND
8	AUD3_IN+	XLR 3_PIN 2		AUD3_OUT+
9	AUD3_IN-	XLR 3_PIN 3		AUD3_OUT-
10	GND	XLR 4_PIN 1	PROG 2.	GND
11	AUD4_IN+	XLR 4_PIN 2		AUD4_OUT+
12	AUD4_IN-	XLR 4_PIN 3		AUD4_OUT-
13	GND	N/C		GND
MDR PIN #	FUNCTION	XLR (MALE)	SB5 CAM FUNCTION (INTERCOM)	SB5 CAM FUNCTION (AUDIO MDR)
14	GND	XLR 1_PIN 1	I-COM CH1	GND
15	AUD1_OUT+	XLR 1_PIN 2		AUD1_IN+
16	AUD1_OUT-	XLR 1_PIN 3		AUD1_IN-
17	GND	XLR 2_PIN 1	I-COM CH2	GND
18	AUD2_OUT+	XLR 2_PIN 2		AUD2_IN+
19	AUD2_OUT-	XLR 2_PIN 3		AUD2_IN-
20	GND	XLR 3_PIN 1		GND
21	AUD3_OUT+	XLR 3_PIN 2		AUD3_IN+
22	AUD3_OUT-	XLR 3_PIN 3		AUD3_IN-
23	GND	XLR 4_PIN 1		GND
24	AUD4_OUT+	XLR 4_PIN 2		AUD4_IN+
25	AUD4_OUT-	XLR 4_PIN 3		AUD4_IN-
26	GND	N/C		GND

Data Pinout

The VB Data Card uses a 15-position, high-density, D-SUB female socket connector. It supports one Bidirectional Tally, one GPIO Bidirectional Channel, and two Data Channels transport up to 3Mbps. The LEDs on the front panel will turn on showing the data paths are active. *Note: the HD15 pinout does not match the SilverBack V Camera Data HD15.*

Data can be set in different configurations based on customer specifications. The cards can be configured for RS232, RS422 or RS485 by changing the switch settings. RS232 and RS422 operate in full duplex mode while RS485 operates in half duplex.

<i>DIP</i>	POSITION	MODE
<i>BOTTOM</i>	SW1 OFF	CH1 RS232
	SW1 ON	CH1 RS422/RS485
<i>TOP</i>	SW2 OFF	CH2 RS232
	SW2 ON	CH2 RS422/RS485

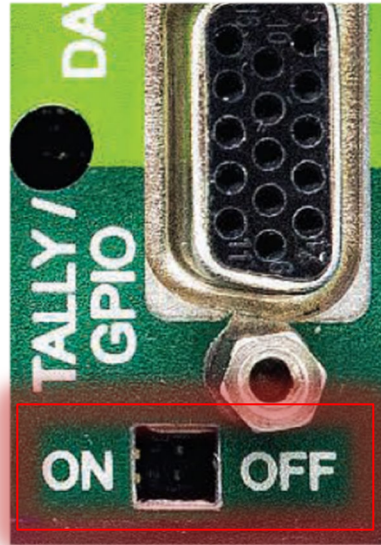

DATA FORMAT

On RS485 applications, the TX and RX pins must be connected together with a small 680 Ohm Resistor. See Figure below for a simplified diagram for the resistor connections.

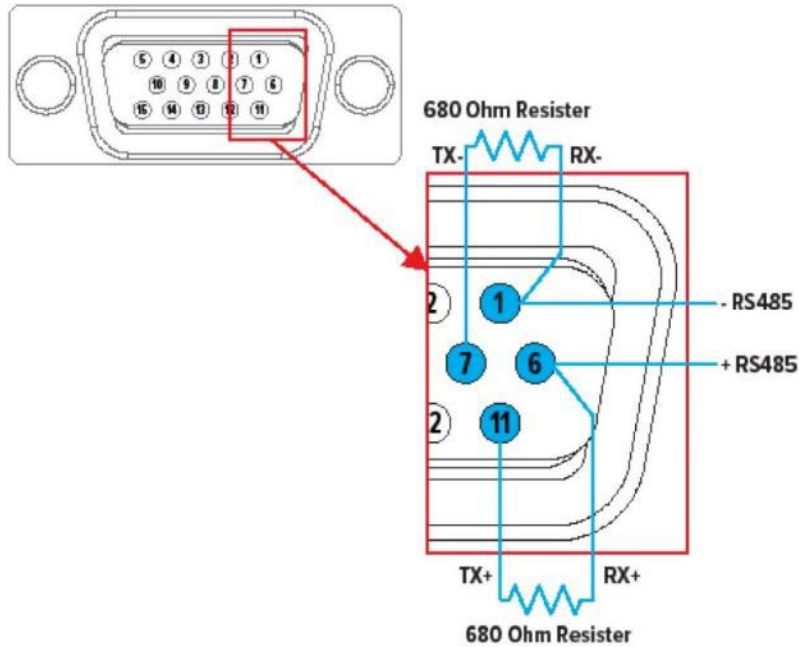

Pin Number	VB Function	232/485	422	SB5 Cam Function
1	CH1 RX-	DATA 1 RXD	DATA 1 RXD IN-	See <i>Camera Unit Serial Data Connector Pinout</i> in Appendix A
6	CH1 RX+	N/C	DATA 1 RXD IN+	
7	CH1 TX-	DATA 1 TXD	DATA 1 TXD OUT-	
11	CH1 TX+	N/C	DATA 1 TXD OUT+	
2	CH2 RX+	N/C	DATA 2 RXD IN+	
8	CH2 RX-	DATA 2 RXD	DATA 2 RXD IN-	
12	CH2 TX+	N/C	DATA 2 TXD OUT+	
3	CH2 TX-	DATA 2 TXD	DATA 2 TXD OUT-	
9	TALLY IN			TALLY RED OUT
10	GPI			TALLY GREEN OUT
13	GPO			N/A
4	TALLY OUT			GPI-1 In
14/15	GND			
5	+12V			

APPENDIX A - TECHNICAL SPECIFICATIONS

SDI Video

Interface	SMPTE ST259, ST292, ST425, ST2081, ST2082
Data Rate	270Mbps, 1.5Gbps, 3Gbps, 6Gbps, 12Gbps
Number of Channels (camera unit to base unit)	1 to 8, depending on model ordered
Number of Channels (base unit to camera unit)	1 to 8, depending on model ordered
Input/Output Level	800mVp-p
Input/Output Impedance	75 ohms
Connector, Camera Unit	HDBNC
Connector, Base Unit	HDBNC
Embedded Audio Supported	Yes

Video, Genlock

Type	Analog black burst, HD tri-level
Impedance	75 ohms, terminated internally
Level	1Vp-p
Connector, Camera Unit	HDBNC
Connector, Base Unit	HDBNC

Audio

Type	Balanced analog, AES3
Number of Channels (bidirectional)	4 analog, 2 AES, 2 MIC/Line (cam to base only) 4 channels total each direction
Level (Analog)	+4dBu nominal, +24dBu max
MIC Input Adjustment Range	0 to 60dB
Input Impedance	> 10k ohms
Output Impedance	50 ohms
THD+N	Better than 0.1%
Frequency Response	+0.1 dB/-3dB, 20Hz to 20kHz
MIC Phantom Power	48V
AES Sampling	24-bit, 48kHz
Connector, Camera Unit	MDR-26, miniXLR (MIC/Line inputs)
Connector, Base Unit	DB25 (Tascam compatible)

Intercom

Number of Channels	2
Interface	2-Wire or 4-Wire
Compatibility	RTS, ClearCom
Headset MIC Type	Dynamic
Headset MIC Impedance	200 ohms nominal
Level, 4-Wire	+4dBu nominal, +24dBu max
Level, 2-Wire	-10dBu nominal
Connector, Headset	miniXLR-5
Connector, Base Unit	DB25 (Sony/Panasonic CCU compatible)

Serial Data (Control)

Type	RS232, RS422, LANC
Number of Channels (bidirectional)	2
Data Rate	1Mbps max
Connector, Camera Unit	HD15
Connector, Base Unit	DB9 (2)

Ethernet

Data Rates	10/100/1000 Base-T
Connector	RJ45 Cat5e

Tally/GPIO

Number of Channels (base unit to camera unit)	3
Number of Channels (camera unit to base unit)	1
Input type	Short to GND or TTL low to activate
Output Type	Relay contact closure (30V, 2A max)
Connector, Camera Unit	HD15
Connector, Base Unit	DB25 (shared with intercom)

Timecode

Type	SMPTE/EBU LTC
Input	Unbalanced, 7Vp-p max
Output	Unbalanced, 3Vp-p max
Connector, Camera Unit	HDBNC
Connector, Base Unit	HDBNC

Electro-Optical

Operating Wavelengths	1271-1611nm
TX Laser Output Power	0dBm (Class 1 Laser)
Receiver Sensitivity	-24dBm(1.25G), -20dBm(3G), -14dBm(12G)
Optical Budget*	16dB (3G models), 10dB (12G/gearbox models)
Fiber Compatibility	Single-mode
Available Optical Connector Types	opticalCON DUO, SMPTE 304M, ST, LC

* The number, quality, and cleanliness of all fiber cables and interconnection points in the fiber path will affect the maximum usable cable length.

Power

Power Input, Base Unit	IEC320, universal input, 90-250VAC, 50-60Hz
Power Consumption, Base Unit	450W max
Power Input, Camera	
Remote Power	Hybrid fiber connector, 54 VDC
Local Power	Battery mount (Anton Bauer or V-mount), 11-17 VDC
Power Consumption, Camera Unit	30W max
Total Power Available from Camera Unit via Hybrid Fiber for Camera and Accessories*	14V (nominal), 150W max
Auxiliary Power Outputs from Camera Unit	2
Connector Type	D-Tap
Power Output	14V (nominal), 5A max (each)

* Maximum powered hybrid fiber distance varies and is determined by the size of the hybrid cable and the overall system power requirements. Power consumption of the camera, viewfinder, lens, and any other accessories will affect maximum available power at any given distance.

Mechanical/Environmental

Dimensions	
Camera Unit	6" x 7" x 4"
Base Unit	19" x 22" x 3.5" (2RU)
Operating Temperature	0 to 40°C
Operating Temperature	0 to 95% RH, non-condensing

Compliance

Laser Safety	Class 1 Laser
Other	RoHS

Connector Pinouts – Camera Unit

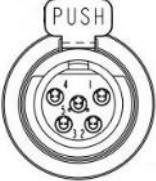
Intercom Headset Pinout		
 miniXLR-5F	Number	Description
	1	GND
	2	MIC Input+
	3	GND
	4	Audio L Output
	5	Audio R Output

MIC/Line Audio Input (MIC 1 and MIC 2) Connector and Pinout		
 miniXLR-3F	Number	Description
	1	GND
	2	Input+
	3	Input-

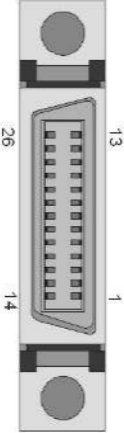
Four Channel Line Level I/O Connector (AUDIO I/O) and Pinout (26-Pin MDR)				
 MDR26-F	Number	Description	Number	Description
	1	GND	14	GND
	2	Ch1 Analog Audio Input- or AES1 Input-	15	Ch1 Analog Audio Output+ or AES1 Output -
	3	Ch1 Analog Audio Input+ or AES1 Input+	16	Ch1 Analog Audio Output- or AES1 Output +
	4	GND	17	GND
	5	Ch2 Analog Audio Input+	18	Ch2 Analog Audio Output +
	6	Ch2 Analog Audio Input-	19	Ch2 Analog Audio Output -
	7	GND	20	GND
	8	Ch3 Analog Audio Input+ or AES2 Input+	21	Ch3 Analog Audio Output + or AES2 Output +
	9	Ch3 Analog Audio Input- or AES2 Input-	22	Ch3 Analog Audio Output - or AES2 Output -
	10	GND	23	GND
	11	Ch4 Analog Audio Input+	24	Ch4 Analog Audio Output +
	12	Ch4 Analog Audio Input-	25	Ch4 Analog Audio Output -
	13	GND	26	GND
Follows MultiDyne VB Audio Series convention				

Camera Unit Serial Data Connector Pinout					
Number	RS422 Pinout	RS232 Pinout	Number	RS422 Pinout	RS232 Pinout
1	Data1 RXD In-	Data1 RXD	9	Data2 TTL Bias	N/C
2	Data1 RXD In+	N/C	10	GND	GND
3	N/C	Tie to GND	11	Data1 TXD Out-	Data1 TXD
4	Data2 RXD In-	Data2 RXD	12	Data1 TXD Out+	N/C
5	Data2 TXD Out+	N/C	13	N/C	N/C
6	Data1 TTL Bias	N/C	14	Data2 TXD Out-	Data2 TXD
7	GND	GND	15	Data2 RXD In+	N/C
8	N/C	Tie to GND			

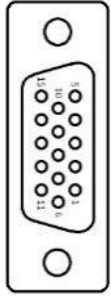

HDB15-F

GPIO Connections

Your SilverBack V camera unit may be equipped with a GPIO port for interfacing with other devices and/or controlling certain functions within the camera unit.

Camera Unit GPIO Connector Pinout				
Number	Description	Number	Description	
1	Red Tally Output	9	GND	
2	Green Tally Output	10	GND	
3	GPO 1 Output	11	Ch1 ICOM MIC Talk Trigger GPI Input	
4	GPI 1 Input	12	Ch2 ICOM MIC Talk Trigger GPI Input	
5	N/C	13	VF Input Select GPI Input	
6	GND	14	Future Use GPI Input	
7	GND	15	+12VDC Output, 1A Max	
8	GND			

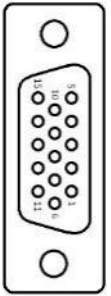

HDB15-F

The GPIO functions are as follows:

- Generic GP input passed down to the base unit.
- Generic GP output passed up from the base unit (relay contact closure).
- Red tally output (relay contact closure).
- Green tally output (relay contact closure).
- Two headset MIC PTT GP inputs (one for each intercom channel).
- External Viewfinder Source Select GP input.
 - Pin connected to Ground: Viewfinder will output return video.
 - Pin open/disconnected: Viewfinder will output video signal connected to viewfinder input.
- Generic GP input for controlling a camera unit function (future use).

Connector Pinouts – Base Unit

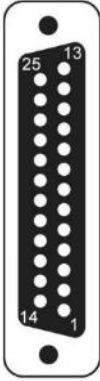
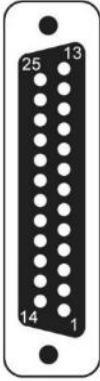
Base Unit Intercom/GPIO Connector Pinout				
 DB25-F	Number	Description	Number	Description
	1	2-Wire Intercom Pin2 (Ch1) or 4-Wire Intercom Ch1 Output+	14	2-Wire Intercom Pin3 (Ch2) or 4-Wire Intercom Ch2 Output+
	2	4-Wire Intercom Ch1 Output-	15	4-Wire Intercom Ch2 Output-
	3	GND	16	GND
	4	4-Wire Intercom Ch1 Input+	17	4-Wire Intercom Ch2 Input+
	5	4-Wire Intercom Ch1 Input-	18	4-Wire Intercom Ch2 Input-
	6	PGM Audio Ch1 Input+	19	PGM Audio Ch2 Input+
	7	PGM Audio Ch1 Input-	20	PGM Audio Ch2 Input-
	8	GND	21	GND
	9	GND	22	GPO Output 1
	10	GPI Input 1	23	N/C
	11	Red Tally GPI Input	24	Green Tally GPI Input
	12	GND	25	GND
	13	GND		
Follows Sony/Panasonic CCU Convention				
Base Unit Audio Connector Pinout				
 DB25-F	Number	Description	Number	Description
	1	Ch4 Analog Audio Output+	14	Ch4 Analog Audio Output-
	2	GND	15	Ch3 Analog Audio Output+ or AES2 Output+
	3	Ch3 Analog Audio Output- or AES2 Output-	16	GND
	4	Ch2 Analog Audio Output+	17	Ch2 Analog Audio Output-
	5	GND	18	Ch1 Analog Audio Output+ or AES1 Output+
	6	Ch1 Analog Audio Output- or AES1 Output-	19	GND
	7	Ch4 Analog Audio Input+	20	Ch4 Analog Audio Input-
	8	GND	21	Ch3 Analog Audio Input+ or AES2 Input+
	9	Ch3 Analog Audio Input- or AES2 Input-	22	GND
	10	Ch2 Analog Audio Input+	23	Ch2 Analog Audio Input-
	11	GND	24	Ch1 Analog Audio Input+ or AES1 Input+
	12	Ch1 Analog Audio Input- or AES1 Input-	25	GND
	13	N/C		
Follows Tascam convention				

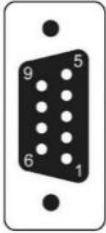
Base Unit Data Connector Pinout			
 <p>DB-9F</p>	Number	RS232 Pinout	RS422 Pinout
	1	N/C	N/C (TTL Bias)
	2	TXD Out	TXD Out -
	3	RXD In	RXD In -
	4	Tie to GND	N/C
	5	GND	GND
	6	N/C	N/C
	7	N/C	TXD Out +
	8	N/C	RXD In +
	9	+12V Out	+12V Out

APPENDIX B - TROUBLESHOOTING

The following table consists of common symptom, probable cause, and test/corrective actions. The probable cause column lists the most common faults that can occur with its corresponding symptom. The test/corrective action column provides a reference to test procedures or specific repairs.

Symptom	Probable Cause	Test/Corrective Action
No power to system	Circuit breaker tripped	Verify that circuit breaker at power source is on. Reset if necessary.
Operational settings are not in synchronization between camera unit and base unit	Camera unit and base unit are not set up correctly	Reference operating procedures
No video	Dirty cable connection	Remove cable and clean both ends, as described below
	Defective video card	Contact MultiDyne
No audio, sync, or data functions	Dirty cable connection	Remove cable and clean both ends, as described below
	Defective circuit card	Contact MultiDyne

Cable Cleaning Procedure

CAUTION!

NEVER use isopropyl alcohol on any fiber connection. If not thoroughly cleaned and dry, isopropyl alcohol can leave residual material on the fiber core, which can interrupt signal flow.

Use only MultiDyne-recommended cleaning products designed for fiber optic cable connections. MultiDyne recommends Sticklers Fiber Optic Connector Cleaner and Benchtop Clean Wipes. For in-depth cleaning, MultiDyne recommends Bulkhead Ferrule Cleaner tool.

Do not scrub the fiber against the wipe. This can cause scratches to the fiber connection. In addition, do not reuse wipes as residual dirt can be transmitted to other cable connections.

Use a fiberscope to inspect the LC connectors for dirt or damage.

- If cable connection is **damaged**, check the connection at both the camera unit and the base unit
- If cable connection is **dirty**:
 - Fold a lint-free Sticklers Benchtop Clean Wipe into a square.
 - Moisten one section of the wipe with a small amount of Sticklers Connector Cleaner.
 - Lightly wipe the connector end.
 - Dry using the other end of the wipe.
 - Repeat this procedure using a fresh wipe for the other cables that need to be cleaned.

Re-inspect the LC connectors using a fiberscope to be sure connection has been cleaned.

For more in-depth cleaning, use the Bulkhead Ferrule Cleaner device.

- Make sure to use the correct size for the connector being cleaned.

- Prime the cleaner and place on the cable end to thoroughly clean the connection.
- Repeat this step for the other cables, as needed.

APPENDIX C - UPDATING SYSTEM SOFTWARE

Overview

The firmware update feature allows user to update the CPU and FPGA software through the use of a microSD card without using any dedicated programmers. To use the SD card firmware update feature. Turn off the SilverBack V, place the update file (.bin) for the desired system card onto the microSD card, turn on the unit and navigate to the appropriate menu to perform the update process.

When updating a unit with multiple system cards of the same type, they will be updated automatically one by one. Please allow the update process to finish completely before removing the power.

User menu input will be disabled for the duration of the software update and will be re-enabled when software update is completed.

Note: Please only place one update file onto the SD card at a time.

For the SBV Base unit, Frame controller software Version 1.1.4 or higher is required to support software updates.

For the SBV Camera unit, Main controller software Version 1.8 or higher is required to support software updates.

For SBV FPGA updates and remote updates of the Camera unit from the Base unit, the following software revisions are required:

- Base Unit Frame Controller version 1.1.8
- Base Unit Main Board version 1.0.17
- Camera Unit Main Board version 2.1

Base Unit Update Process

This feature will update the cards in the SilverBack base unit through the microSD card. User has the ability to individually update the two cameras.

To use the Silverback V Base Update feature:

- First, turn off the SilverBack V base unit
- Place the update file (.bin) onto the microSD card
- Insert the card into the SilverBack V base unit
- Turn on the unit
- Navigate to the base firmware update menu.
 - To navigate to the base firmware update menu: Base Menu → Maintenance → Perform System Update.

On the update screen, it will display the name of the file used in the update, the size of the file, the intended card that will be updated and the current firmware version of the card/cards.

Select one of the cameras to update and the display will show “Update done” when the update process is finished.



If the power supply software is being updated, Update Cam1 button will update the 12V and 48V power supply for camera 1. Update Cam2 button will update the 12V and 48V power supply for camera 2.

If multiple cards of the same type are installed in each camera chain, e.g. 3G SDI cards, they will all be updated automatically, one at a time.

Each CPU Software update takes around 2 minutes and each FPGA Firmware takes around 5 minutes. A power cycle is recommended after performing any system updates.

System software may also be updated from the webpage dashboard. The Base Software Update box can be found on the webpage after the Base configuration settings.

Base software update

Update file name: SVBPS013.BIN

Update file size: 5728

Update card name: PSU

The Base Frame Controller Software is updated using a different procedure, it cannot be updated from the front panel menus or from the webpage dashboard.

To update the SBV base frame controller card:

- Turn off SilverBack V base unit.
- Remove the microSD card
- Place the update.bin file onto the microSD card.
- Insert the card into the SilverBack V base unit.
- Turn on the base unit.

The frame controller will automatically load the new software and boot from the new software.

Camera Unit Update Process

This feature will update the cards in the SilverBack V camera unit through the microSD card.

To use the Silverback V Camera Update Feature:

- First, turn off the SilverBack V camera unit
- Place the update file (.bin) onto the microSD card
- Insert the card into the SilverBack V camera unit
- Turn on the unit.
- Navigate to the camera firmware update menu.
 - To navigate to the camera firmware update menu: System settings → Maintenance → Card Update.

On the update screen, it will display the name of the card that will be updated, the update version and the software version currently installed.



Select update to start the update process and it will show “Done” in green when the update process is finished.

Each CPU Software update takes around 2 minutes and each FPGA Firmware update takes around 5 minutes.

SilverBack V remote camera update process

This feature allows user to update the software in the camera unit from the base unit. This is useful when the camera is located in hard to reach places.

To use the Silverback V Remote Camera Update Feature:

- Turn off both SilverBack V camera and base unit
- Place the update file (.bin) onto the microSD card
- Insert the card into the SilverBack V base unit
- Turn on the units.

- Navigate to the remote camera firmware update menu in the Base Unit.
 - To navigate to the base remote update menu: Cam Menu → Camera 1 OR Camera 2 → Card Update.



On the update screen, it will display the name of the file used in the update, the size of the file and the intended card that will be updated.

Remote Camera Unit software updates can also be invoked from the webpage dashboard instead of the front panel menu. You can find the Remote Camera Software Update box on the webpage after the Camera Remote Controls section.

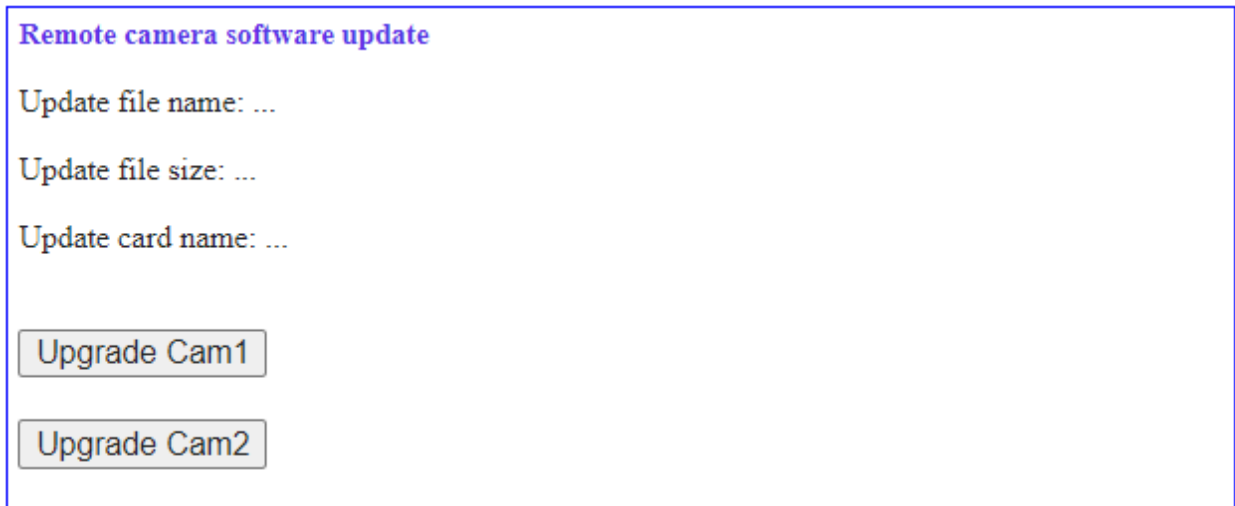

Each remote Software update takes around 4 minutes to complete and each remote FPGA Firmware update takes around 30 minutes due to messaging protocol overhead over the fiber.

