

# ZONE WIRED 2

Setup Guide  
设置指南

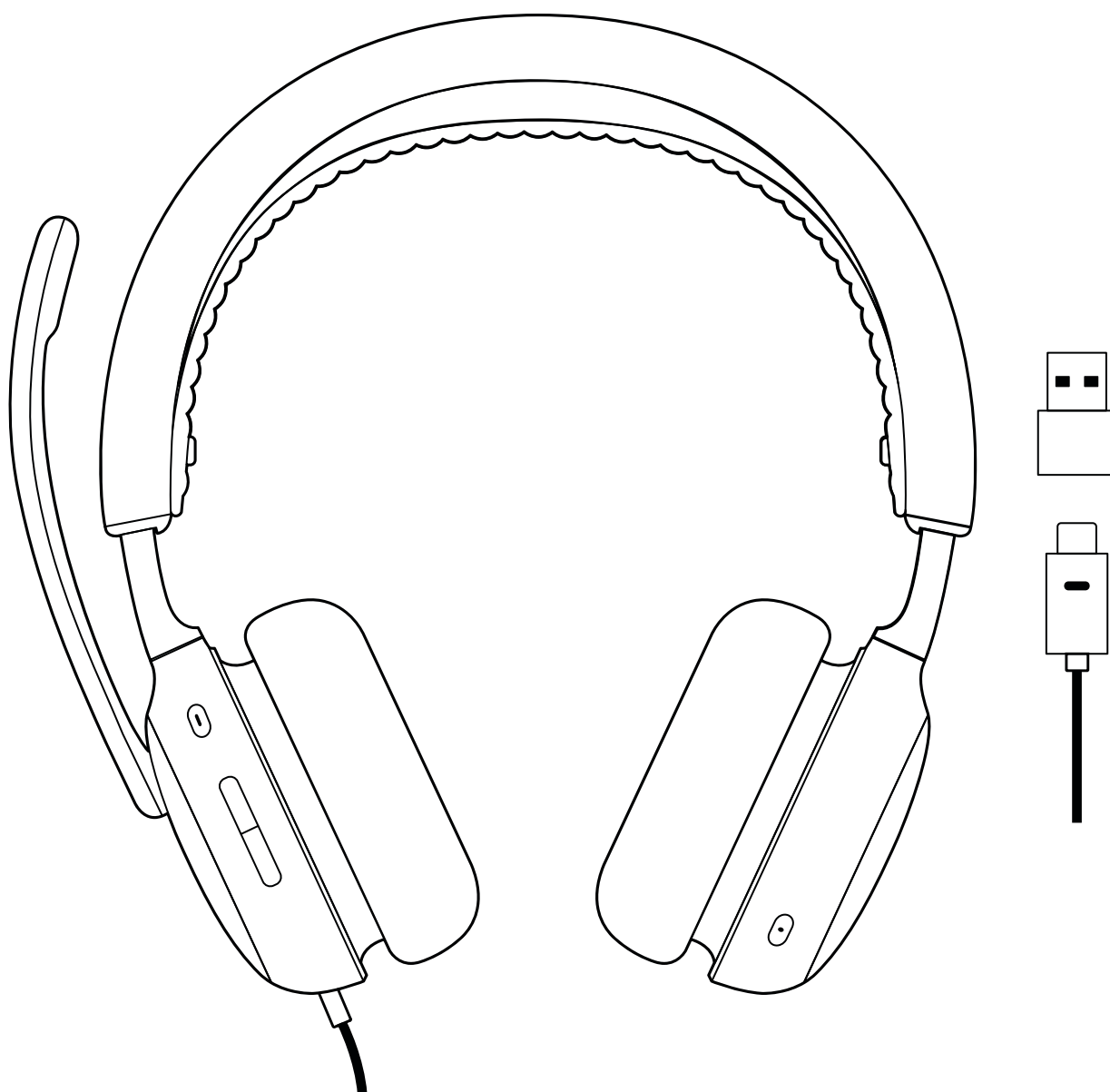

logitech 罗技®

# CONTENTS

English . . . . . 3

简体中文 . . . . . 11

# KNOW YOUR PRODUCT

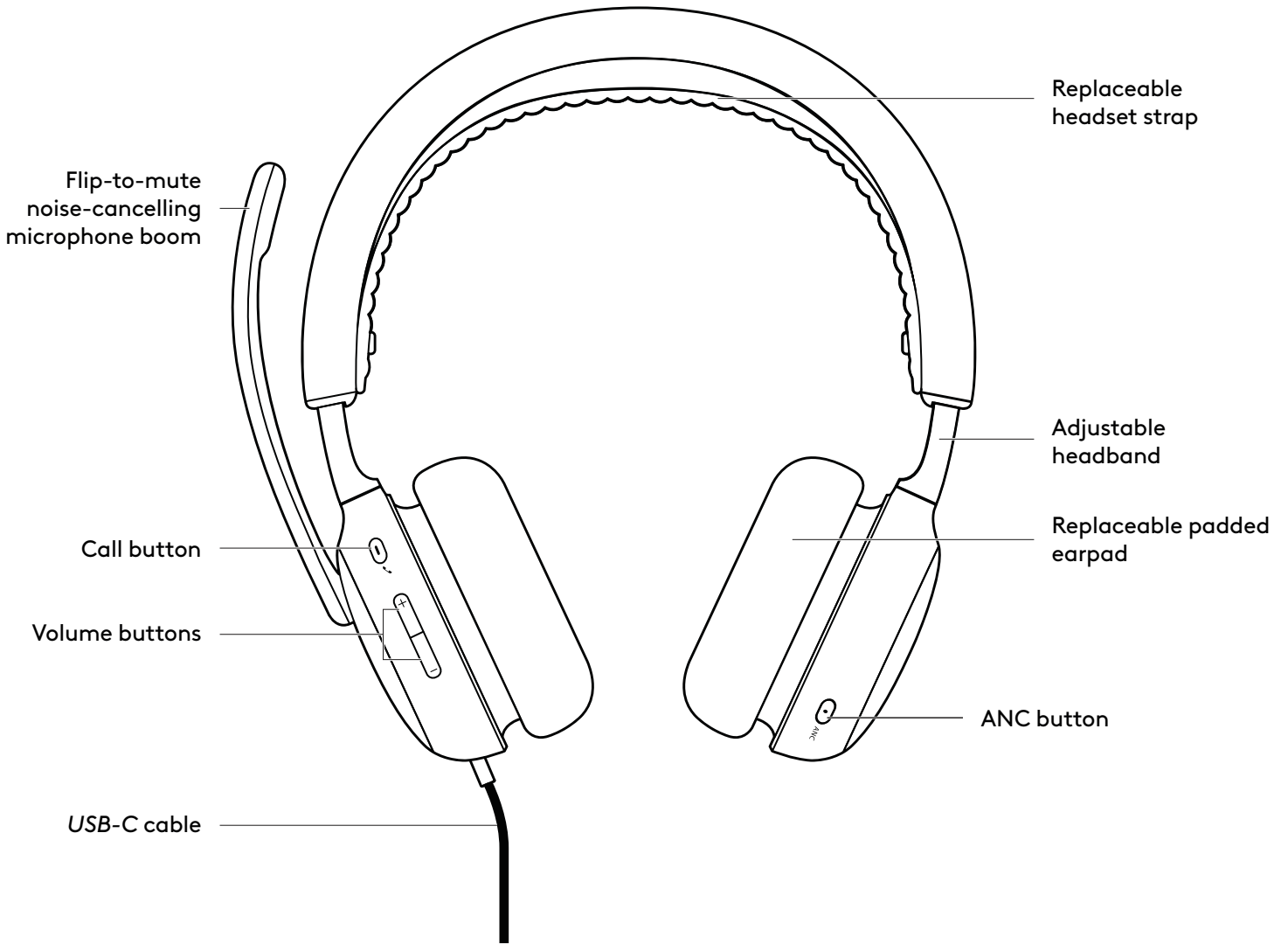

## USB PLUG AND ADAPTER

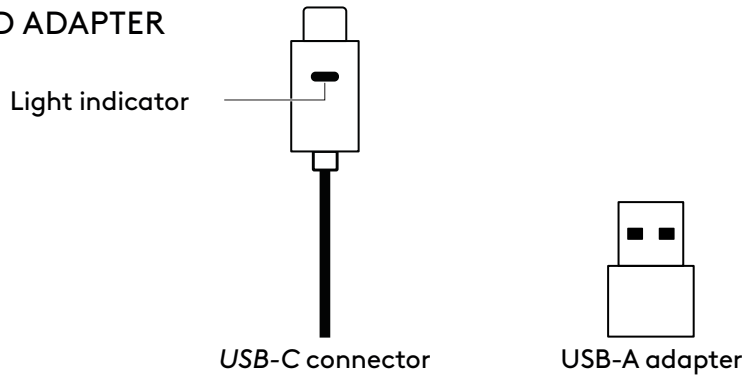

## WHAT'S IN THE BOX

1. Headset
2. USB-A adapter
3. Travel bag
4. User documentation

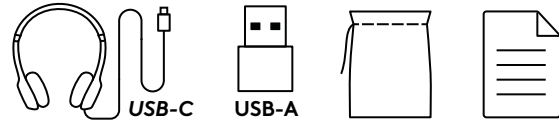

## CONNECT YOUR HEADSET

Plug the *USB-C* connector into the computer *USB-C* port. Or use the provided *USB-A* adapter to plug the headset into the computer *USB-A* port.

**Note:** Only use the *USB-A* adapter with the provided headset.

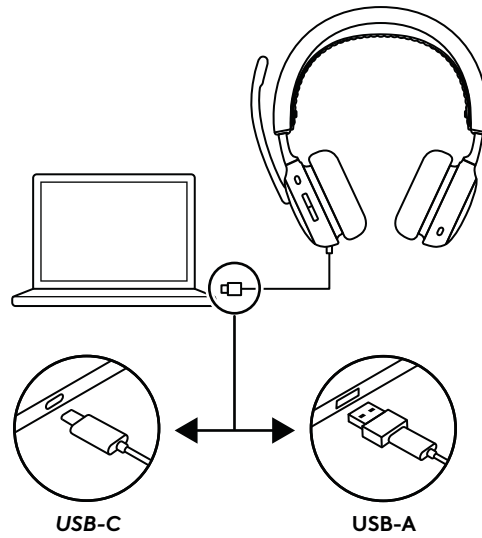

## ADJUSTING HEADSET

1. Adjust the headset by sliding earcups up and down the headband.
2. Swivel earcups to fit on your ear.
3. It may be easier to adjust the headset on your head. Move the earcups up and down the headband until they sit comfortably on your ears.

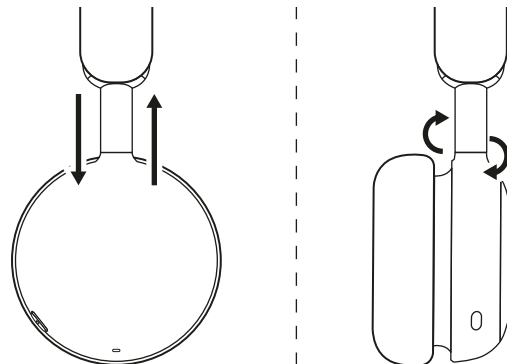

## ADJUSTING THE MICROPHONE BOOM

The microphone boom rotates 270 degrees. Wear it on either the left or right side. The audio channel will switch automatically, depending on the direction you are wearing the microphone.

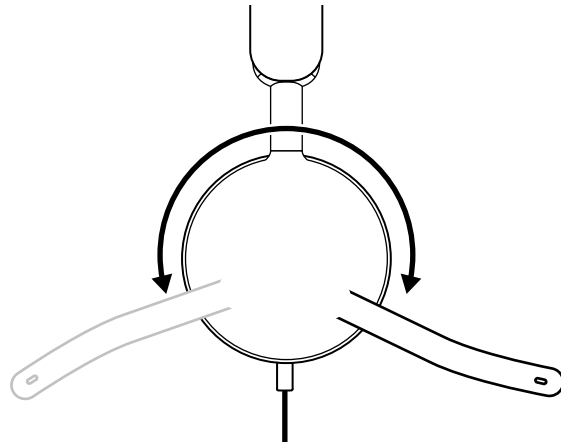

Mic boom should be placed close or next to your mouth, aligned with the corner of the mouth.

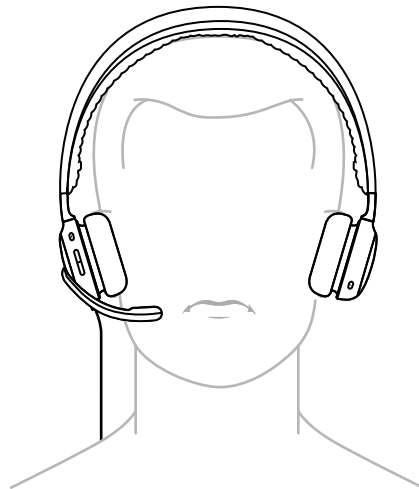

## HEADSET CONTROLS

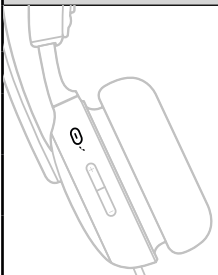
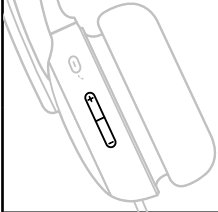
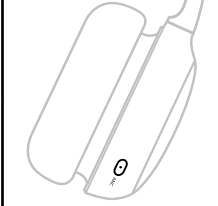
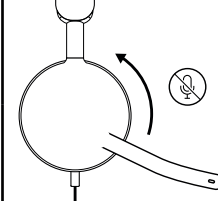
Button	Usage		Action
	<b>Call controls<sup>1</sup></b>	Answer / End call	Short press
		Reject call	2 seconds press
	<b>Media controls (Enable with Logi Tune)</b>	Play / Pause	Short press
		Next track	Double press
		Previous track	Triple press
	<b>Volume controls</b>	Volume up	Short press "+"
		Volume down	Short press "-"
	<b>ANC controls<sup>1</sup></b>	Toggle between ANC and Transparency On	Short press
		ANC off	2 seconds press
	<b>Mute</b>	Mute on	Mic boom flip up
		Mute off	Mic boom flip down

**Note:**

- Voice prompts indicate when the mic is mute on/off.<sup>2</sup>

### ACTIVE NOISE CANCELLATION (ANC)

ANC blocks out the noise around you to help you concentrate on the task at hand.

- Press the ANC button on the side of the earcup to toggle between ANC and Transparency mode.
- There will be voice prompts when switching between modes.<sup>2</sup>

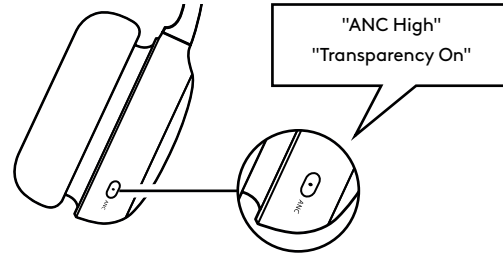

**Note:** ANC button can be customized to cycle through up to 5 different modes on Logi Tune app.

### CONNECTOR LIGHT INDICATOR

Light		Status
White	Solid	Ongoing call
	Flashing	Incoming call
Red	Solid	Mute on
Purple and White	Blinking	Headset firmware updating

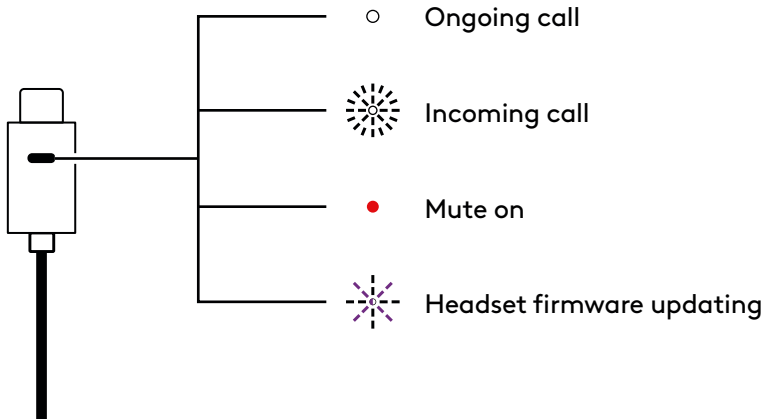

## LOGI TUNE

Logi Tune helps boost your headset performance with periodic software and firmware updates. Learn more and download Logi Tune at [logitech.com/tune](https://logitech.com/tune).



## ADJUSTING SIDETONE

**Sidetone** lets you hear your own voice while speaking so you are aware of how loud you are talking. In Logi Tune app, select the sidetone feature, wear your headset, adjust the setting while speaking.

- A higher number means you hear more external sound.
- A lower number means you hear less external sound.

## MIC EQ

Customize Mic EQ in Logi Tune to adjust your voice to sound brighter or deeper.

## HEARING PROTECTION

Zone Wired 2 provides three types of protection to help you hear safely.

**Peak limiting:** Audio volume is always limited at 100dBA to prevent hearing damages.

**Anti-startle protection:** It limits sudden audio spikes to avoid acoustic shocks as per Australian G616 guideline. This can be enabled on the Logi Tune app and applies to call activities only.

**Noise exposure over time:** It monitors the average daily noise levels in calls not to exceed time-weighted average of 85dBA as per Australian G616 guideline. This can be enabled on the Logi Tune app and applies to call activities only.

## ENABLE EQ FOR CALLS

Logi Tune now lets you apply equalizer settings to call audio in addition to music. Customize the sound you hear in calls with deeper bass, crisper treble, or any other preferred settings.

Turn on the "Enable EQ for calls" toggle in Logi Tune to use your customized equalizer settings for calls.

## POWER SAVING MODE

Activate Power Saving Mode in Logi Tune to lower power usage from the device your headset is connected to.

When enabled, the headset will automatically turn off Active Noise Cancellation (ANC) and the light indicator after 30 minutes of inactivity to save power.

To wake up the headset, simply start using the headset by joining a call, listening to music or pressing any button.

## UPDATE YOUR HEADSET

We recommend updating your headset to ensure optimal performance.

To do so, download Logi Tune from [logitech.com/tune](https://logitech.com/tune) and check for available firmware updates.

## DIMENSIONS

### Headset:

Height x Width x Depth:  
185.2 x 183.6 x 73.0 mm

### Weight:

223.5 g

### Adapter:

Height x Width x Depth:  
24.5 x 15.4 x 8.7 mm

## SYSTEM REQUIREMENTS

Works with common calling applications across almost all platforms and operating systems.

Works with *Windows*, *Mac*, or *Chrome*-based computer<sup>3</sup> via *USB-C* or *USB-A*.

## TECHNICAL SPECIFICATIONS

Microphone type: 2 noise-canceling mics with AI-based algorithm and Mic EQ

Frequency response (headset): 20 Hz – 20 kHz (music mode), 100 Hz – 8 kHz (talk mode)

Frequency response (microphone): 100 Hz – 8 kHz

Cable length: 1.9 m

Audio compliance: EN 50332-2 compliant

## FOOTNOTE

<sup>1</sup> Customize the button in Logi Tune. Check Logi Tune compatibility on [logi.com/tune](https://logi.com/tune).

<sup>2</sup> The headset currently supports voice prompts in the following languages with the Logi Tune desktop app: English, French, German and Spanish. You can choose your preferred language in the app.

<sup>3</sup> Device basic functions will be supported for operating systems that do not support Logi Tune.

[www.logitech.com/support/zone-wired-2](https://www.logitech.com/support/zone-wired-2)

# 了解您的产品

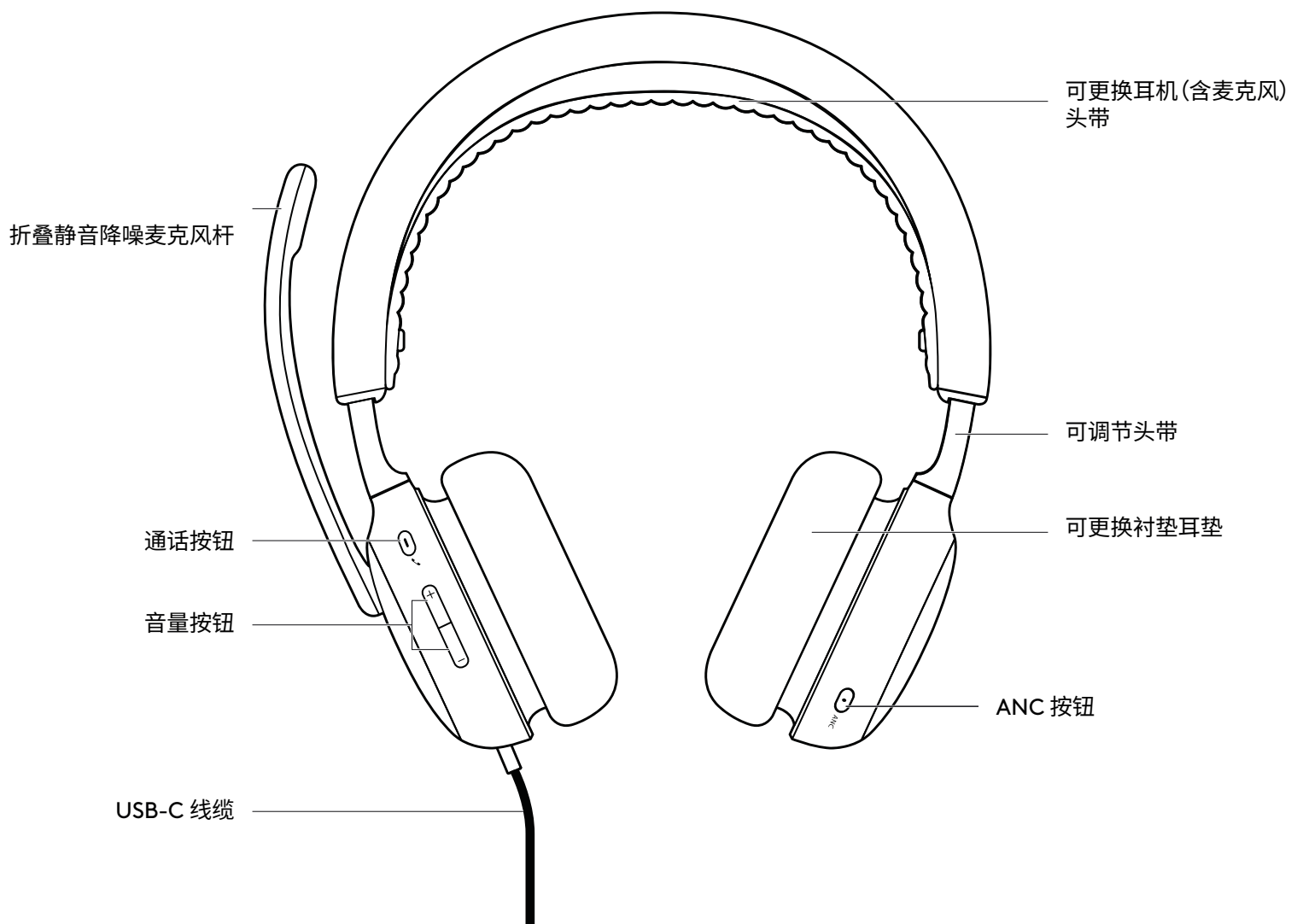

## USB 插头和适配器

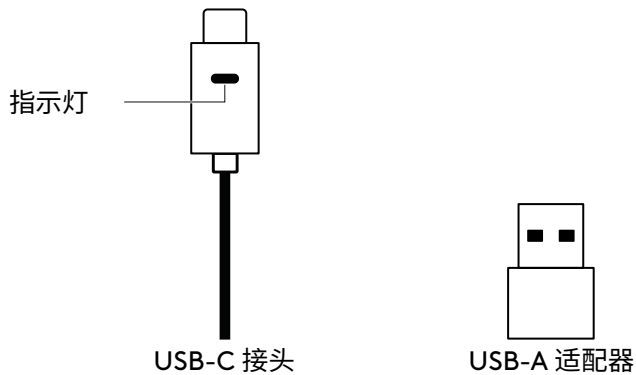

## 包装内容

1. 耳机(含麦克风)
2. USB-A 适配器
3. 便携包
4. 用户文档

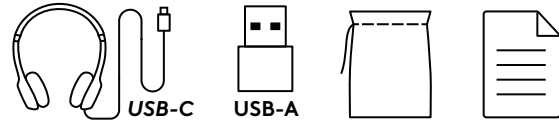

## 连接耳机(含麦克风)

将 USB-C 接头插入电脑的 USB-C 端口。或使用随附的 USB-A 适配器，将耳机(含麦克风)插入电脑的 USB-A 端口。

**注:**仅可使用 USB-A 适配器搭配随附的耳机(含麦克风)。

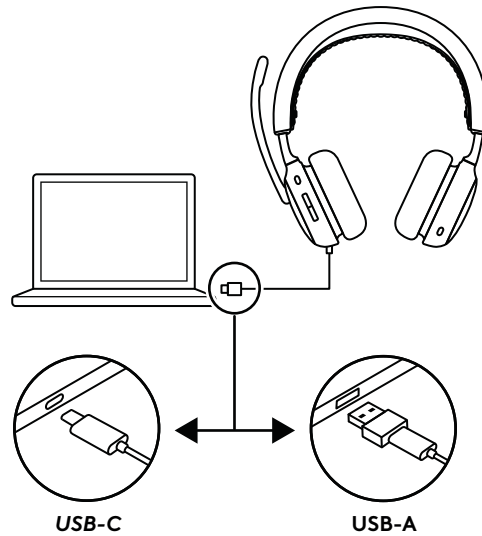

## 调整耳机(含麦克风)

1. 通过头带上下滑动耳罩调节耳机(含麦克风)以佩戴。
2. 旋转耳罩以贴合耳部。
3. 带好耳机(含麦克风)后将使得耳机(含麦克风)更易调整。在头带处上下移动耳罩，直至舒适贴合耳部。

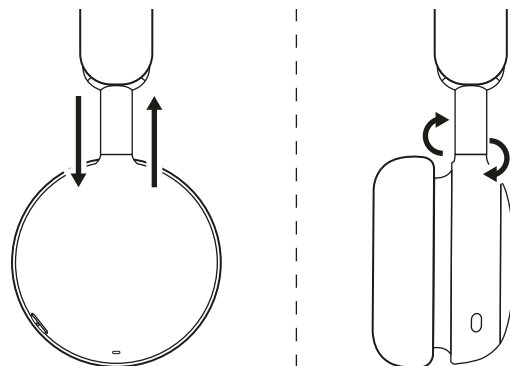

## 调整麦克风杆

麦克风杆可旋转 270 度。将其佩戴于左右均可。音频通道将自动切换，具体取决于您佩戴麦克风的方向。

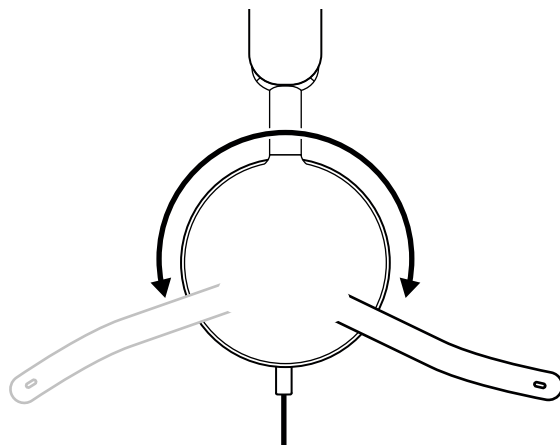

麦克风杆应靠近嘴部放置，与嘴角对齐。

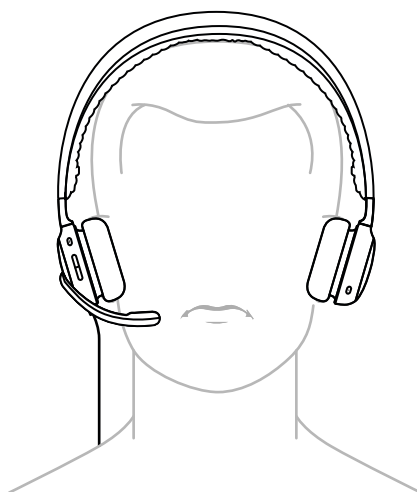

## 耳机(含麦克风)控制

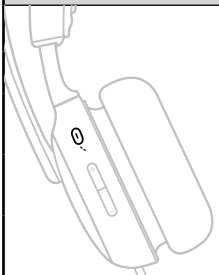
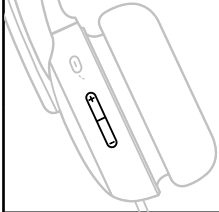
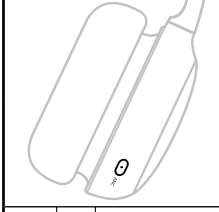
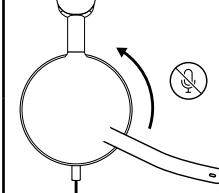
按钮	使用		操作
	通话控制 <sup>1</sup>	接听/结束通话	短按
		拒绝通话	按 2 秒
	媒体控制 (通过 Logi Tune 启用)	播放/暂停	短按
		下一曲目	按两次
	上一曲目	按三次	
	音量控制	音量上升	短按 “+”
		音量下降	短按 “-”
	ANC 控制 <sup>1</sup>	在 ANC 和通透模式之间切换	短按
		ANC 关闭	按 2 秒
	静音	静音开启	麦克风杆向上翻转
		取消静音	麦克风杆向下翻转

### 注:

- 语音提示会指示麦克风静音状态。<sup>2</sup>

## 主动降噪 (ANC)

ANC 可以阻隔您周围的噪音, 帮助您专注于手头的任务。

- 按下耳罩侧面的 ANC 按钮可在 ANC 和通透模式之间切换。
- 切换模式时会有语音提示。<sup>2</sup>

**注意:** ANC 按钮可在 Logi Tune 应用程序中自定义设置为循环切换最多 5 种不同的模式。

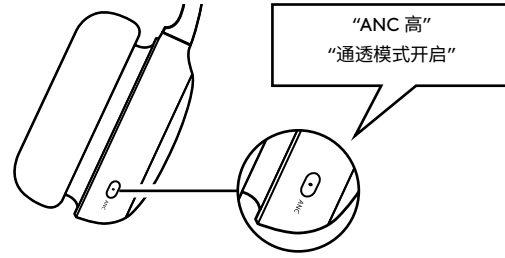

## 接口指示灯

指示灯		状态
白色	常亮	通话中
	闪烁	通话呼入
红色	常亮	静音开启
紫色和白色	闪烁	耳机(含麦克风)固件更新

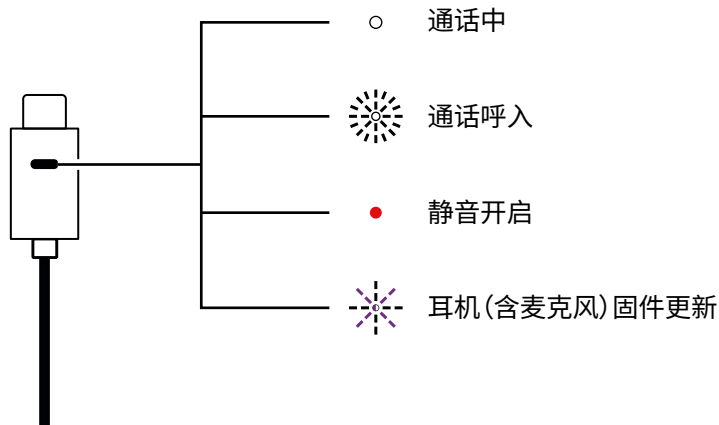

## LOGI TUNE

Logi Tune 通过定期的软件和固件更新帮助改善耳机 (含麦克风) 性能。了解更多和下载 Logi Tune, 请访问 [logitech.com/tune](https://logitech.com/tune)



### 调节侧音

**侧音** 让您可以在发言中听到自己的声音, 以了解自己的说话音量。在 Logi Tune 应用程序中, 选择侧音功能, 佩戴耳机 (含麦克风), 在说话时调节设置。

- 数字越大表示您听到的外部声音越多。
- 数字越小表示您听到的外部声音越少。

### 麦克风均衡器

在 Logi Tune 中自定义麦克风均衡器, 调整您的声音, 使其听起来更清亮或更低沉。

### 听力保护

Zone Wired 2 提供三种类型的保护, 助您安全聆听。

**峰值限制:** 音量阈值始终限制为 100dBa, 以防止听力受损。

**防护声音冲击:** 根据澳大利亚 G616 指南要求, 限制突发的音频尖峰信号, 以避免声震。此功能可在 Logi Tune 应用程序中启用且仅应用于通话活动。

**噪声暴露随时间的变化:** 根据澳大利亚 G616 指南, 监控日均通话噪音水平, 确保通话噪音不超过 85dBa 的时间加权平均值。此功能可在 Logi Tune 应用程序中启用且仅应用于通话活动。

### 启用通话均衡器

除播放音乐以外, Logi Tune 目前还可将均衡器设置应用于通话音频。自定义通话音质, 可增强低音效果、提升高音清晰度, 或根据个人喜好进行其他设置。

在 Logi Tune 中开启“启用通话均衡器”开关, 即可在通话时使用自定义的均衡器设置。

## 省电模式

在 Logi Tune 中激活省电模式,以降低耳机(含麦克风)所连接设备的功耗。

启用后,耳机(含麦克风)将在闲置 30 分钟后自动关闭主动降噪(ANC)和指示灯,以节省电量。

要唤醒耳机(含麦克风),只需通过接听电话、播放音乐或按任意按钮即可使用耳机(含麦克风)。

## 更新耳机(含麦克风)

建议您更新耳机(含麦克风),以获得出众性能。为此,请从 [logitech.com/tune](https://logitech.com/tune) 下载 Logi Tune,并检查是否有可用的固件更新。

## 尺寸

### 耳机(含麦克风):

高 x 宽 x 深:

约185.2 x 约183.6 x 约73.0 毫米

### 重量:

约223.5 克

### 适配器:

高 x 宽 x 深:

约24.5 x 约15.4 x 约8.7 毫米

## 系统要求

兼容多数平台和操作系统的常用通话应用程序。通过 USB-C 或 USB-A 支持 Windows、Mac 或基于 Chrome 的电脑<sup>3</sup>。

## 技术规格

麦克风类型:2 个降噪麦克风,搭载基于人工智能的算法和麦克风均衡器

频率响应(耳机(含麦克风)):20 Hz 至 20 kHz(音乐模式),100 Hz 至 8 kHz(通话模式)

频率响应(麦克风):100 Hz 至 8 kHz

线缆长度:约1.9 米

音频合规性:符合 EN 50332-2 标准

## 附注

<sup>1</sup> 在 Logi Tune 中自定义按钮。查看 Logi Tune 兼容性, 请访问 [logi.com/tune](https://logi.com/tune)。

<sup>2</sup> 耳机(含麦克风) 目前通过 Logi Tune 桌面应用程序支持以下语言的语音提示: 英语、法语、德语和西班牙语。您可以在应用程序中选择首选语言。

<sup>3</sup> 不支持 Logi Tune 的操作系统亦可支持设备的基本功能。

[www.logitech.com/support/zone-wired-2](https://www.logitech.com/support/zone-wired-2)

© 2025 Logitech. Logitech, 罗技, Logi, Zone, and the Logitech logo are trademarks or registered trademarks of Logitech Europe S.A. and/or its affiliates in the U.S. and other countries. *Windows* is a trademark of the Microsoft group of companies. *macOS* is a trademark of Apple Inc. *Google*, *ChromeOS*, and *Chrome* are trademarks of Google LLC. *USB-C* is a trademark of USB Implementers Forum. All other third party trademarks are the property of their respective owners. Logitech assumes no responsibility for any errors that may appear in this manual. Information contained herein is subject to change without notice.

版权所有 © 2025 罗技。罗技、Logitech、Logi、Zone 和罗技标志为罗技欧洲公司和/或其美国及其他国家/地区附属公司的商标，并已注册。*Windows* 是 Microsoft 集团公司的商标。*macOS* 是 Apple Inc. 的商标。*Google*、*ChromeOS* 和 *Chrome* 是 Google LLC 的商标。*USB-C* 是 USB Implementers Forum 的商标。所有其他第三方商标均为其各自所有者的财产。罗技对于本手册中可能出现的任何错误不承担任何责任。本手册中包含的信息如有更改，恕不事先通知。