

Dell Pro Micro

QCM1255

Owner's Manual

Notes, cautions, and warnings

 **NOTE:** A NOTE indicates important information that helps you make better use of your product.

 **CAUTION:** A CAUTION indicates either potential damage to hardware or loss of data and tells you how to avoid the problem.

 **WARNING:** A WARNING indicates a potential for property damage, personal injury, or death.

Chapter 1: Views of Dell Pro Micro QCM1255	7
Front view.....	7
Back.....	8
Top.....	10
Chapter 2: Set up your computer	11
Chapter 3: Specifications of Dell Pro Micro QCM1255	16
Dimensions and weight.....	16
Processor.....	16
Chipset.....	17
Operating system.....	18
Memory.....	18
Memory matrix.....	18
External ports and slots.....	19
Internal slots.....	20
Ethernet.....	20
Wireless module.....	20
Audio.....	21
Storage.....	21
Storage matrix.....	21
Power adapter.....	22
GPU—Integrated.....	22
Video port resolution (GPU—Integrated).....	23
External display support (GPU—Integrated).....	23
Hardware security.....	23
Environmental.....	24
Regulatory compliance.....	24
Operating and storage environment.....	24
Dell Optimizer.....	25
Chapter 4: Working inside your computer	26
Safety instructions.....	26
Before working inside your computer.....	26
Safety precautions.....	27
Electrostatic discharge—ESD protection.....	27
ESD Field Service kit	28
Transporting sensitive components.....	29
After working inside your computer.....	29
BitLocker.....	29
Information on repairability for Québec - From Dell Canada Inc. - to Quebec consumers.....	29
Recommended tools.....	29
Screw list.....	30
Major components of Dell Pro Micro QCM1255.....	31

Chapter 5: Removing and installing side cover.....	34
Removing the side cover.....	34
Installing the side cover.....	35
Chapter 6: Removing and installing coin-cell battery.....	36
Removing the coin-cell battery.....	36
Installing the coin-cell battery.....	37
Chapter 7: Removing and installing Customer Replaceable Units (CRUs).....	38
Speaker.....	38
Removing the speaker.....	38
Installing the speaker.....	39
Solid state drive.....	39
Removing the M.2 2230 solid-state drive in a single SSD configuration.....	40
Installing the M.2 2230 solid-state drive in a single SSD configuration.....	40
Removing the M.2 2280 solid-state drive in a single SSD configuration.....	42
Installing the M.2 2280 solid-state drive in a single SSD configuration.....	43
Removing the M.2 2230 solid-state drive in a dual SSD configuration.....	45
Installing the M.2 2230 solid-state drive in a dual SSD configuration.....	46
Removing the M.2 2280 solid-state drive in a dual SSD configuration.....	48
Installing the M.2 2280 solid-state drive in a dual SSD configuration.....	49
Wireless card.....	50
Removing the wireless card.....	50
Installing the wireless card.....	50
Fan.....	52
Removing the fan.....	52
Installing the fan.....	53
Memory.....	55
Removing the memory module.....	55
Installing the memory module.....	55
External puck antenna.....	57
Removing external puck antenna.....	57
Installing external puck antenna module.....	58
SMA antenna module.....	59
Removing SMA antenna module.....	59
Installing SMA antenna module.....	60
Optional Input/Output modules.....	61
Dual USB 3.2 Gen 2 ports module.....	61
USB Type-C port module with DisplayPort Alt mode and Power Delivery.....	63
DisplayPort module.....	68
HDMI port module.....	71
VGA port module.....	74
PS2 port module.....	77
Serial port module.....	80
Fiber optic port module.....	83
Chapter 8: Removing and installing Field Replaceable Units (FRUs).....	87
Heat sink.....	87

Removing the heat sink.....	87
Installing the heat sink.....	88
Internal antenna module.....	89
Removing the antenna module (white cable).....	89
Installing the antenna module (white cable).....	91
Removing the antenna module (black cable).....	92
Installing the antenna module (black cable).....	93
Processor.....	94
Removing the processor.....	94
Installing the processor.....	95
Speaker holder.....	96
Removing the speaker holder.....	96
Installing the speaker holder.....	97
System board.....	98
Removing the system board.....	98
Installing the system board.....	101
Chapter 9: Software.....	106
Operating system.....	106
Drivers and downloads.....	106
Chapter 10: BIOS Setup.....	107
Entering BIOS Setup program.....	107
Navigation keys.....	107
One time boot menu.....	107
F12 One Time Boot menu.....	108
System setup options.....	108
Updating the BIOS.....	117
Updating the BIOS in Windows.....	117
Updating the BIOS in Linux and Ubuntu.....	118
Updating the BIOS using the USB drive in Windows.....	118
Updating the BIOS from the One-Time boot menu.....	118
Updating the BIOS.....	119
Updating the BIOS in Windows.....	119
Updating the BIOS using the USB drive in Windows.....	119
Updating the BIOS in Linux and Ubuntu.....	120
Updating the BIOS from the One-Time boot menu.....	120
System and setup password.....	120
Assigning a System Setup password.....	120
Deleting or changing an existing system password or setup password.....	121
Clearing CMOS settings.....	121
Clearing system and setup passwords.....	121
Chapter 11: Troubleshooting.....	122
Dell SupportAssist Pre-boot System Performance Check diagnostics.....	122
Running the SupportAssist Pre-Boot System Performance Check.....	122
Power-Supply Unit Built-in Self-Test	122
System-diagnostic lights.....	122
Recovering the operating system.....	123

Real-Time Clock—RTC reset.....	124
Backup media and recovery options.....	124
Network power cycle.....	124
Chapter 12: Getting help and contacting Dell.....	125
Chapter 13: Revision history.....	126

Views of Dell Pro Micro QCM1255

Front view

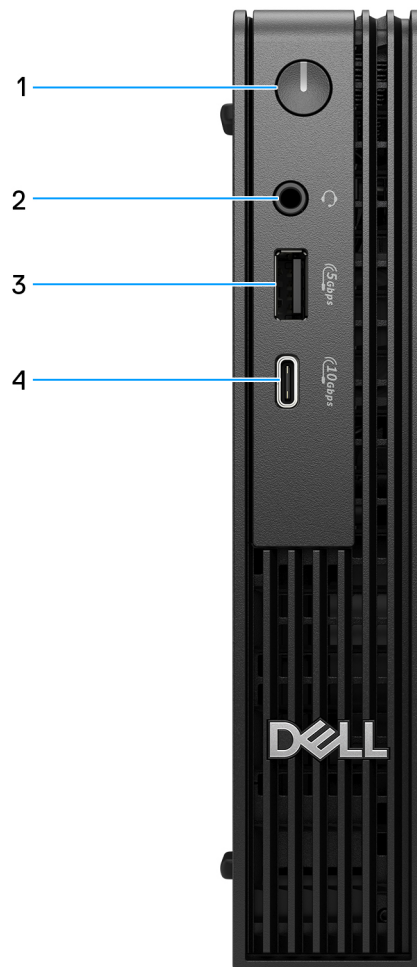

Figure 1. Front view

1. Power button

Press to turn on the computer if it is turned off, in sleep state, or in hibernate state. When the computer is turned on, press the power button to put the computer into a sleep state; press and hold the power button for 10 seconds to force shut-down the computer.

2. Headset (headphone and microphone combo) port

Connect headphones or a headset.

3. USB 3.2 Gen 1 (5 Gbps) port

Connect devices such as external storage devices and printers. Provides a data transfer speed of up to 5 Gbps.

4. USB 3.2 Gen 2 (10 Gbps) Type-C port

Connect devices such as external storage devices and printers. Provides a data transfer speed of up to 10 Gbps.

Back

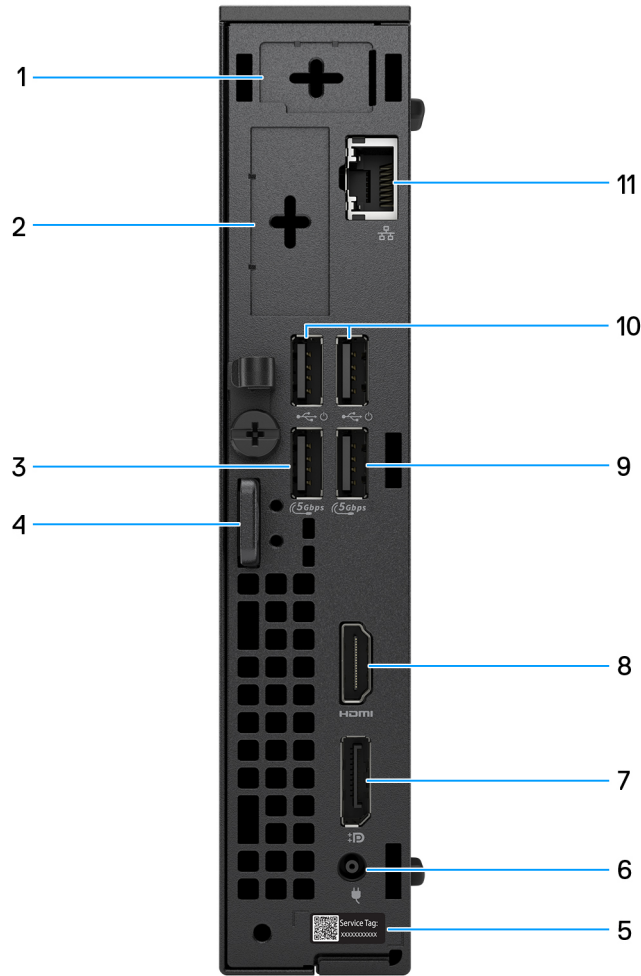

Figure 2. Back view

1. Optional external antenna port

Supports an optional external antenna module.

2. Optional I/O module port

Supports an optional I/O module with one of the following ports:

- HDMI 2.1 (FRL) port
- DisplayPort 1.4a (HBR3) port
- VGA port
- USB 3.2 Gen 2 Type-C with DisplayPort Alt Mode port and 100W Power Input
- Two USB 3.2 Gen 2 ports
- PS2 port
- Serial port
- Fiber optic port (5 Gbps, peer-to-peer)

NOTE: Supports up to 5 Gbps connectivity in peer-to-peer transmission. Actual speed via network depends on equipment compatibility, requiring both transceiver and switch at the same maximum speed.

3. USB 3.2 Gen 1 (5 Gbps) port

Connect devices such as external storage devices and printers. Provides data transfer speeds of up to 5 Gbps.

4. Kensington security-cable slot and padlock ring

Connect a security cable to prevent unauthorized movement of your computer and install a standard padlock to prevent unauthorized access to the interior of your computer.

5. Service Tag label

The Service Tag is a unique alphanumeric identifier that enables Dell service technicians to identify the hardware components in your computer and access warranty information.

6. Power-adaptor port

Connect a power adaptor to provide power to your computer.

7. DisplayPort 1.4a (HBR3) port

Connect an external display or a projector.

8. HDMI 2.1 (TMDS) port

Connect a gaming console, Blu-ray player, or other HDMI-out enabled device.

9. USB 3.2 Gen 1 (5 Gbps) port

Connect devices such as external storage devices and printers. Provides data transfer speeds of up to 5 Gbps.

10. Two USB 2.0 (480 Mbps) ports with Smart Power On

Connect devices such as external storage devices and printers. Provides data transfer speeds of up to 480 Mbps.



NOTE: When USB wake is enabled in the BIOS, the computer will turn on or resume from hibernation when a USB device that is connected to this port, such as a mouse or keyboard is used.

11. RJ45 ethernet port (Up to 1 Gbps)

Connect an ethernet (RJ45) cable from a router or a broadband modem for network or Internet access, with a transfer rate of 10/100/1000 Mbps (maximum 1 Gbps).

Top



Figure 3. Top view of Dell Pro Micro QCM1255

1. MyDell QR code

MyDell is your hub for content personalized to your Dell Pro Micro QCM1255, including videos, articles, manuals, and easy access to support.

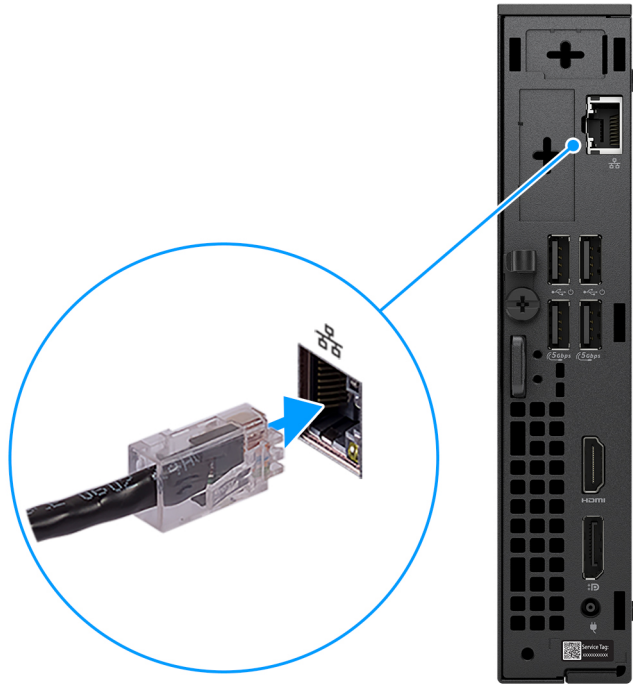

Figure 5. Connect to your network using a cable, or connect to a wireless network

3. Connect the display. For more information about setting up the display, see the documentation that is shipped with your display.



Figure 6. Connect the display

4. Connect the power cable to the computer and then connect it to the wall outlet.

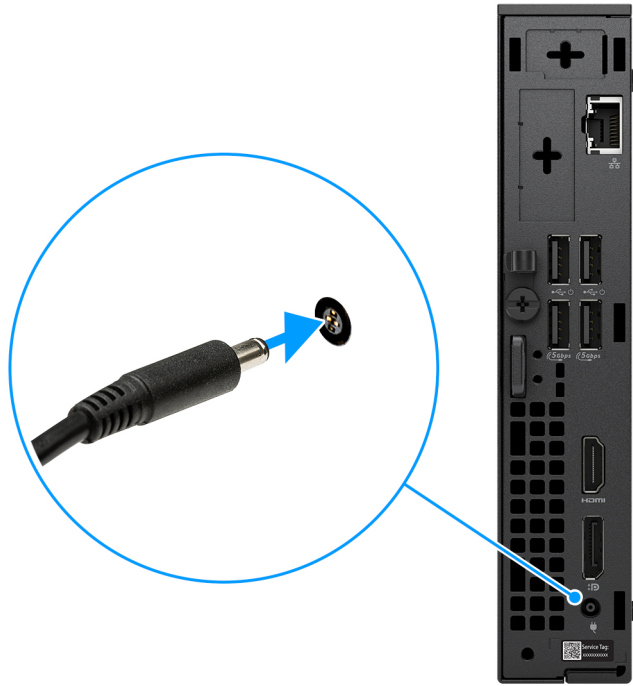

Figure 7. Setup your computer

5. Press the power button at the front of the computer to turn on the computer.



Figure 8. Press the power button

6. Finish the operating system setup.

For Ubuntu:

Follow the on-screen instructions to complete the setup. For more information about installing and configuring Ubuntu, search in the Knowledge Base Resource at [Dell Support Site](#).

For Windows:

Follow the on-screen instructions to complete the setup. When setting up, Dell Technologies recommends that you:





- Connect to a network for Windows updates.

NOTE: If connecting to a secured wireless network, enter the password for the wireless network access when prompted.

- If connected to the Internet, sign-in with or create a Microsoft account. If not connected to the Internet, create an offline account.
- On the **Support and Protection** screen, enter your contact details.

7. Locate and use Dell apps from the Windows Start menu—Recommended.

Table 1. Locate Dell apps

Resources	Description
	<p>Dell Optimizer is an application is designed to enhance computer performance and productivity by optimizing settings for power, battery, display, collaboration touchpad, and presence detection. It also provides access to applications purchased with your new computer.</p> <p>For more information, see Dell Optimizer User's Guide at Dell Support Site</p>
	<p>Dell Product Registration</p> <p>Register your computer with Dell.</p>
	<p>Dell Help & Support</p> <p>Access help and support for your computer.</p>
	<p>SupportAssist</p> <p>SupportAssist is a proactive and predictive technology that offers automated technical support for Dell computers. It proactively monitors both hardware and software, addressing performance issues, preventing security threats, and automating engagement with Dell Technical Support.</p> <p>For more information, see Support Assist documentation at Dell Support Site.</p> <p> NOTE: In SupportAssist, click the warranty expiry date to renew or upgrade your warranty.</p>

Specifications of Dell Pro Micro QCM1255

Dimensions and weight

The following table lists the height, width, depth, and weight of your Dell Pro Micro QCM1255.

Table 2. Dimensions and weight

Description	Values
Height	182.00 mm (7.17 in.)
Width	36.00 mm (1.41 in.)
Depth	178.00 mm (7.01 in.)
Weight  NOTE: The weight of your computer depends on the configuration that is ordered and manufacturing variability.	<ul style="list-style-type: none"> • Maximum - 1.39 kg (3.05 lbs) • Minimum - 1.17 kg (2.57 lbs)

Processor

The following table lists the details of the processors that are supported by your Dell Pro Micro QCM1255.

Table 3. Processor

Description	Option one	Option two	Option three	Option four	Option five	Option six
Processor type	AMD Ryzen 7 PRO 8700GE	AMD Ryzen 5 PRO 8600GE	AMD Ryzen 5 PRO 8500GE	AMD Ryzen 5 8500GE	AMD Ryzen 3 PRO 8300GE	AMD Ryzen 3 8300GE
Processor wattage	35 W	35 W	35 W	35 W	35 W	35 W
Processor total core count	8	6	6	6	4	4
Processor total thread count	16	12	12	12	8	8
Processor frequency						
Maximum Boost frequency	5.10 GHz	5.00 GHz	5.00 GHz	5.00 GHz	4.90 GHz	4.90 GHz
Base frequency	3.65 GHz	3.90 GHz	3.40 GHz	3.40 GHz	3.50 GHz	3.50 GHz
Processor cache	24 MB	22 MB	22 MB	22 MB	12 MB	12 MB
Integrated graphics	AMD Radeon 780M Graphics	AMD Radeon 760M Graphics	AMD Radeon 740M Graphics	AMD Radeon 740M Graphics	AMD Radeon 740M Graphics	AMD Radeon 740M Graphics
AI technology	AMD Ryzen AI	AMD Ryzen AI	None	None	None	None
Neural Processing Unit (NPU) performance	16 TOPS	16 TOPS	Not applicable	Not applicable	Not applicable	Not applicable
 NOTE: Tera Operations Per Second (TOPS) is an AI performance metric that measures how many trillions of operations per second an AI processor can perform.						

Chipset

The following table lists the details of the chipset that is supported in your Dell Pro Micro GCM1255.

Table 4. Chipset

Description	Option one
Chipset	AMD PRO 665
Processors	<ul style="list-style-type: none"> • AMD Ryzen 7 PRO 8700GE • AMD Ryzen 5 PRO 8600GE • AMD Ryzen 5 PRO 8500GE • AMD Ryzen 5 8500GE • AMD Ryzen 3 PRO 8300GE • AMD Ryzen 3 8300GE
DRAM bus width	128-bit
Flash EPROM	64 MB non-RPMC + 2 MB non-RPMC
PCIe bus	Up to Gen4
Non-volatile memory	Yes

Table 4. Chipset (continued)

Description	Option one
BIOS configuration Serial Peripheral Interface (SPI)	512 Mbit (64 MB) located at SPI_FLASH
Trusted Platform Module (TPM) 2.0 (Discrete TPM Enabled)	24 KB located at TPM 2.0 on chipset
Firmware-TPM (Discrete TPM disabled)	Not supported
NIC EEPROM	LOM configuration contained within SPI flash ROM instead of LOM e-fuse

Operating system

Your Dell Pro Micro QCM1255 supports the following operating systems:

- Windows 11 Home
- Windows 11 Pro
- Windows 11 Pro National Education
- Ubuntu Linux 24.04 LTS, 64-bit

Memory

The following table lists the memory specifications that are supported by your Dell Pro Micro QCM1255.

Table 5. Memory specifications

Description	Values
Memory slots	Two SODIMM slots
Memory type	DDR5
Memory speed	4800 MT/s
Maximum memory configuration	64 GB
Minimum memory configuration	8 GB
Memory size per slot	8 GB, 16 GB, or 32 GB
Memory configurations supported	<ul style="list-style-type: none"> • 8 GB, 1 x 8 GB, DDR5, 4800 MT/s, single-channel • 16 GB, 1 x 16 GB, DDR5, 5600 MT/s, dual-channel • 16 GB, 2 x 8 GB, DDR5, 4800 MT/s, dual-channel • 32 GB, 1 x 32 GB, DDR5, 5600 MT/s, dual-channel • 32 GB, 2 x 16 GB, DDR5, 4800 MT/s, dual-channel • 64 GB, 2 x 32 GB, DDR5, 4800 MT/s, dual-channel

Memory matrix

The following table lists the memory configurations supported on your Dell Pro Micro QCM1255.

Table 6. Memory matrix

Configuration	Slot	
	SODIMM1	SODIMM2
8 GB DDR5	8 GB	

Table 6. Memory matrix (continued)

Configuration	Slot	
	SODIMM1	SODIMM2
16 GB DDR5	16 GB	
16 GB DDR5	8 GB	8 GB
32 GB DDR5	32 GB	
32 GB DDR5	16 GB	16 GB
64 GB DDR5	32 GB	32 GB

External ports and slots

The following table lists the external ports and slots of your Dell Pro Micro QCM1255.

Table 7. External ports and slots

Description	Values
Network port	One RJ45 ethernet port (1 Gbps)
USB ports	<ul style="list-style-type: none"> • One USB 3.2 Gen 2 (10 Gbps) Type-C port • Three USB 3.2 Gen 1 (5 Gbps) ports • Two USB 2.0 (480 Mbps) ports with Smart Power On
Audio port	One headset (headphone and microphone combo) port
Video port(s)	<ul style="list-style-type: none"> • One HDMI 2.1 (TMDS) port • One DisplayPort 1.4a (HBR3 support) port
Power-adaptor port	One 4.5 mm DC-in port
Security-cable slot	<ul style="list-style-type: none"> • One security-cable slot (for Kensington locks) • One padlock ring
Optional port	<ul style="list-style-type: none"> • One external antenna port • One I/O module port <p>i NOTE: The optional I/O module port can be configured with one of the following options:</p> <ul style="list-style-type: none"> ○ One HDMI 2.1 (FRL) port ○ One DisplayPort 1.4a (HBR3 support) port ○ One VGA port ○ One USB 3.2 Gen 2 Type-C port with DisplayPort Alt Mode and 100W Power Input ○ Two USB 3.2 Gen 2 ports ○ One PS2 port ○ One serial port ○ One fiber optic port (5 Gbps, peer-to-peer) <p>NOTE: Supports up to 5 Gbps connectivity in peer-to-peer transmission. Actual speed via network depends on equipment compatibility, requiring both transceiver and switch at the same maximum speed.</p>

Internal slots

The following table lists the internal slots of your Dell Pro Micro QCM1255.

Table 8. Internal slots

Description	Values
M.2	<ul style="list-style-type: none"> One M.2 2230 slot for Wi-Fi and Bluetooth combo card Two M.2 2230/2280 Gen4 slots for solid-state drive <p>NOTE: To learn more about the features of different types of M.2 cards, search Dell Support Site.</p>

Ethernet

The following table lists the wired ethernet Local Area Network (LAN) specifications of your Dell Pro Micro QCM1255.

Table 9. Ethernet specifications

Description	Values
Model	Realtek RTL8111EPP
Transfer rate	10/100/1000 Mbps

Wireless module

The following table lists the Wireless Local Area Network (WLAN) modules that are supported on your Dell Pro Micro QCM1255.

Table 10. Wireless module specifications

Description	Option one	Option two
Model number	MediaTek MT7925	MediaTek MT7920
Transfer rate	Up to 2882 Mbps	Up to 1200 Mbps
Frequency bands supported	2.4 GHz/5 GHz/6 GHz	2.4 GHz/5 GHz
Wireless standards	<ul style="list-style-type: none"> WiFi 802.11a/b/g Wi-Fi 4 (WiFi 802.11n) Wi-Fi 5 (WiFi 802.11ac) Wi-Fi 6 (WiFi 802.11ax) Wi-Fi 7 (WiFi 802.11be) 	<ul style="list-style-type: none"> WiFi 802.11a/b/g Wi-Fi 4 (WiFi 802.11n) Wi-Fi 5 (WiFi 802.11ac) Wi-Fi 6 (WiFi 802.11ax)
Encryption	<ul style="list-style-type: none"> 64-bit/128-bit WEP AES-CCMP TKIP 	<ul style="list-style-type: none"> 64-bit/128-bit WEP AES-CCMP TKIP
Bluetooth wireless card NOTE: The functionality of the Bluetooth wireless card may vary based on the operating system.	Bluetooth 5.4	Bluetooth 5.4

Audio

The following table lists the audio specifications of your Dell Pro Micro QCM1255.

Table 11. Audio specifications

Description	Values
Audio type	4 Channel High-Definition Audio
Audio controller	Realtek ALC3204 Codec
Internal audio interface	High-Definition Audio
External audio interface	One headset (headphone and microphone combo) port
Speakers	Internal speakers

Storage

This section lists the storage options on your Dell Pro Micro QCM1255.

Table 12. Storage specifications

Storage type	Interface type	Capacity
M.2 2230 solid state drive	QLC PCIe Gen4 NVMe, Class 25	Up to 1 TB
M.2 2230 solid state drive	TLC Gen4 PCIe NVMe, Class 35	Up to 1 TB
M.2 2280 solid state drive	TLC Gen4 PCIe NVMe, Class 40, Self-Encrypting Opal 2.0, Class 40	Up to 1 TB

NOTE: Your computer supports two SSD configurations.

- **Single SSD configuration:** One SSD is installed in either of the two slots.
- **Dual SSD configuration:** SSDs are installed in both slots.

To upgrade from a single SSD configuration to a dual configuration by adding an SSD, users must install SSD heatsinks on both SSDs to ensure optimal performance. These heatsinks must be purchased separately.

Storage matrix

The following table lists the storage configurations supported on your Dell Pro Micro QCM1255.

Table 13. Storage matrix

Storage	Slot	
	M.2 PCIe SSD-0 (Primary M.2 PCIe for boot function)	M.2 PCIe SSD-1
One M.2 2230 solid-state drive	Yes	
One M.2 2280 solid-state drive	Yes	
Two M.2 2230 solid-state drive	Yes	Yes
Two M.2 2280 solid-state drive	Yes	Yes
One M.2 2230 solid-state drive +	Yes (M.2 2230/2280)	Yes (M.2 2230/2280)

Table 13. Storage matrix (continued)

Storage	Slot	
	M.2 PCIe SSD-0 (Primary M.2 PCIe for boot function)	M.2 PCIe SSD-1
One M.2 2280 solid-state drive		

Power adapter

The following table lists the power adapter specifications of your Dell Pro Micro QCM1255.

Table 14. Power-adapter specifications

Description	Option one	Option two
Type	90 W	65 W
Connector dimensions:		
External diameter	4.50 mm	4.50 mm
Internal diameter	2.90 mm	2.90 mm
Power-adapter dimensions:		
Height	32.00 mm	28.00 mm
Width	52.00 mm	47.00 mm
Depth	128.00 mm	108.00 mm
Input voltage	100 VAC–240 VAC	100 VAC–240 VAC
Input frequency	50 Hz–60 Hz	50 Hz–60 Hz
Input current (maximum)	1.50 A	1.70 A
Output current (continuous)	4.62 A	3.34 A
Rated output voltage	19.5 VDC	19.50 VDC
Temperature range:		
Operating	0°C to 40°C (32°F to 104°F)	0°C to 40°C (32°F to 104°F)
Storage	-40°C to 70°C (-40°F to 158°F)	-40°C to 70°C (-40°F to 158°F)
 CAUTION: Operating and storage temperature ranges may differ among components, so operating or storing the device outside these ranges may impact the performance of specific components.		

GPU—Integrated

The following table lists the specifications of the integrated Graphics Processing Unit (GPU) supported by your Dell Pro Micro QCM1255.

Table 15. GPU—Integrated

Controller	Memory size	Processor
AMD Radeon 780M Graphics	Shared system memory	AMD Ryzen 7 PRO 8700GE

Table 15. GPU—Integrated (continued)

Controller	Memory size	Processor
AMD Radeon 760M Graphics	Shared system memory	AMD Ryzen 5 PRO 8600GE
AMD Radeon 740M Graphics	Shared system memory	<ul style="list-style-type: none"> • AMD Ryzen 5 PRO 8500GE • AMD Ryzen 5 8500GE • AMD Ryzen 3 PRO 8300GE • AMD Ryzen 3 8300GE

Video port resolution (GPU—Integrated)

Table 16. Video port resolution (GPU—Integrated)

Graphics card	Video ports	Maximum supported resolution
AMD Radeon 780M/760M/740M Graphics	One DisplayPort 1.4a (HBR3 support) port	5120 x 3200 @ 60Hz
	One HDMI 2.1 (TMDS) port	4096 x 2160 @ 60 Hz
	One optional port slot which can be configured with one of the following options: <ul style="list-style-type: none"> • HDMI 2.1 (FRL) port • DisplayPort 1.4a (HBR3) port • VGA port • USB Type-C port with DisplayPort Alt Mode 	<ul style="list-style-type: none"> • HDMI 2.1 - Up to 5120 x 3200 @ 60 Hz • DisplayPort 1.4a (HBR3) - 5120 x 3200 @ 60 Hz • VGA - Up to 1920 x 1200 @ 60 Hz • USB Type-C with DisplayPort Alt Mode - Up to 5120 x 3200 @ 60 Hz

External display support (GPU—Integrated)

Display support for the integrated graphics card

Table 17. Display support specifications

Graphics card	Supported external displays
AMD Radeon 780M/760M/740M	Up to 4 simultaneous displays
AMD Radeon 780M/760M/740M + optional module	Up to 4 simultaneous displays

Hardware security

The following table lists the hardware security of your Dell Pro Micro QCM1255.

Table 18. Hardware security

Hardware security
Kensington security-cable slot
Padlock ring
Chassis lock slot support
Chassis intrusion switch
Lockable cable covers
Supply chain tamper alerts

Table 18. Hardware security (continued)

Hardware security
SafelD including Trusted Platform Module (TPM) 2.0
Smart card keyboard (FIPS)
Microsoft 10 Device Guard & Credential Guard (Enterprise SKU)
SafeBIOS: includes Dell Off-host BIOS Verification, BIOS Resilience, BIOS Recovery, and additional BIOS Controls
Microsoft Windows BitLocker
Local hard drive data wipe through BIOS (Secure Erase)
Self-encrypting storage drives (Opal, FIPS)

Environmental

The following table lists the environmental specifications of your Dell Pro Micro QCM1255.

Table 19. Environmental

Feature	Values
Recyclable packaging	Yes
BFR/PVC—free chassis	Yes
Vertical orientation packaging support	Yes
Multi-Pack packaging	Yes
Energy-Efficient Power Supply	Standard
ENV0424 compliant	Yes

NOTE: Wood-based fiber packaging contains a minimum of 35% recycled content by total weight of wood-based fiber. Packaging that contains without wood-based fiber can be claimed as Not Applicable. The anticipated required criteria for EPEAT 2018.

Regulatory compliance

The following table lists the regulatory compliance of your Dell Pro Micro QCM1255.

Table 20. Regulatory compliance

Regulatory compliance
Product Safety, EMC and Environmental Datasheets
Dell Regulatory Compliance Home Page
Responsible Business Alliance policy

Operating and storage environment

This table lists the operating and storage specifications of your Dell Pro Micro QCM1255.

Airborne contaminant level: G1 as defined by ISA-S71.04-1985

Table 21. Computer environment

Description	Operating	Storage
Temperature range	10°C to 35°C (50°F to 95°F)	-40°C to 65°C (-40°F to 149°F)
Relative humidity (maximum)	20% to 80% (non-condensing)	5% to 95% (non-condensing)
Vibration (maximum)*	0.26 GRMS	1.37 GRMS
Shock (maximum)	40 G†	105 G†
Altitude range	-15.2 m to 3048 m (-49.87 ft to 10,000 ft)	-15.2 m to 10,668 m (-49.87 ft to 35,000 ft)
 CAUTION: Operating and storage temperature ranges may differ among components, so operating or storing the device outside these ranges may impact the performance of specific components.		

* Measured using a random vibration spectrum that simulates the user environment.

† Measured using a 2 ms half-sine pulse.

Dell Optimizer

This section details the Dell Optimizer specifications of your Dell Pro Micro QCM1255.

Dell Optimizer is an AI-based software application that allows you to customize your computer settings for power and more. Learn more: [Optimizer at Dell Site](#)

For Dell Pro Micro QCM1255 with Dell Optimizer, you can:









- Tune the performance, power consumption, cooling, and fan noise with selectable thermal modes.
- Download and redeem the apps that are purchased with your computer.

For more information about configuring and using these features, see [Dell Optimizer User Guide](#).

Working inside your computer



Safety instructions

Use the following safety guidelines to protect your computer from potential damage and to ensure your personal safety. Unless otherwise noted, each procedure in this document assumes that you have read the safety information that shipped with your computer.

-  **WARNING:** Before working inside your computer, read the safety information that is shipped with your computer. For more safety best practices, see [Dell Regulatory Compliance Home Page](#).
-  **WARNING:** Disconnect your computer from all power sources before opening the computer cover or panels. After you finish working inside the computer, replace all covers, panels, and screws before connecting your computer to an electrical outlet.
-  **WARNING:** For laptops, discharge the battery completely before removing it. Disconnect the AC power adapter from the computer and operate the computer solely on battery power—the battery is fully discharged when the computer no longer turns on when the power button is pressed.
-  **CAUTION:** To avoid damaging the computer, ensure that the work surface is flat, dry, and clean.
-  **CAUTION:** You should only perform troubleshooting and repairs as authorized or directed by the Dell technical support team. Damage due to servicing that is not authorized by Dell is not covered by your warranty.
-  **CAUTION:** Before touching anything inside your computer, ground yourself by touching an unpainted metal surface, such as the metal at the back of the computer. While you work, periodically touch an unpainted metal surface to dissipate static electricity which could harm internal components.
-  **CAUTION:** To avoid damaging the components and cards, handle them by their edges, and avoid touching the pins and the contacts.
-  **CAUTION:** When you disconnect a cable, pull it by its connector or its pull tab, not the cable itself. Some cables have connectors with locking tabs or thumbscrews that you must disengage before disconnecting the cable. When disconnecting cables, keep them evenly aligned to avoid bending the connector pins. When connecting cables, ensure that the connector on the cable is correctly oriented and aligned with the port.
-  **CAUTION:** Press and eject any installed card from the media-card reader.

Before working inside your computer

 **NOTE:** The images in this document may differ from your computer depending on the configuration you ordered.

1. Save and close all open files and exit all open applications.
2. Shut down your computer. For Windows operating system, click **Start** >  **Power** > **Shut down**.
 -  **NOTE:** If you are using a different operating system, see the documentation of your operating system for shut-down instructions.
3. Turn off all the attached peripherals.
4. Disconnect your computer from the electrical outlet.
5. Disconnect all attached network devices and peripherals, such as keyboard, mouse, and monitor from your computer.

 **CAUTION:** To disconnect a network cable, unplug the cable from your computer.

6. Remove any media card and optical disc from your computer, if applicable.

Safety precautions

This section details the primary steps to be followed before disassembling any device or component.

Observe the following safety precautions before any installation or break-fix procedures involving disassembly or reassembly:

- Turn off the computer and all attached peripherals.
- Disconnect the computer from AC power.
- Disconnect all network cables and peripherals from the computer.
- Use an ESD field service kit when working inside your computer to avoid electrostatic discharge (ESD) damage.
- Place the removed component on an anti-static mat after removing it from the computer.
- Press and hold the power button for 15 seconds to discharge the residual power in the system board.

Bonding

Bonding is a method for connecting two or more grounding conductors to the same electrical potential. This is done by using a field service electrostatic discharge (ESD) kit. When connecting a bonding wire, ensure that it is connected to bare metal and never to a painted or nonmetal surface. Ensure that the wrist strap is secure and in full contact with your skin. Remove all jewelry, watches, bracelets, or rings before grounding yourself and the equipment.

Electrostatic discharge—ESD protection

ESD is a major concern when you handle electronic components, especially sensitive components such as expansion cards, processors, memory modules, and system boards. A slight charge can damage circuits in ways that may not be obvious, such as intermittent problems or a shortened product life span. As the industry pushes for lower power requirements and increased density, ESD protection is an increasing concern.

Two recognized types of ESD damage are catastrophic and intermittent failures.

- **Catastrophic** – Catastrophic failures represent approximately 20 percent of ESD-related failures. The damage causes an immediate and complete loss of device functionality. An example of catastrophic failure is a memory module that has received a static shock and immediately generates a "No POST/No Video" symptom with a beep code that is emitted for missing or nonfunctional memory.
- **Intermittent** – Intermittent failures represent approximately 80 percent of ESD-related failures. The high rate of intermittent failures means that most of the time when damage occurs, it is not immediately recognizable. The memory module receives a static shock, but the tracing is merely weakened and does not immediately produce outward symptoms that are related to the damage. The weakened trace may take weeks or months to melt, and in the meantime may cause degradation of memory integrity, intermittent memory errors, and so on.

Intermittent failures that are also called latent or "walking wounded" are difficult to detect and troubleshoot.

Perform the following steps to prevent ESD damage:

- Use a wired ESD wrist strap that is properly grounded. Wireless anti-static straps do not provide adequate protection. Touching the chassis before handling parts does not ensure adequate ESD protection on parts with increased sensitivity to ESD damage.
- Handle all static-sensitive components in a static-safe area. If possible, use anti-static floor pads and workbench pads.
- When unpacking a static-sensitive component from its shipping carton, do not remove the component from the anti-static packing material until you are ready to install the component. Before unwrapping the anti-static packaging, use the anti-static wrist strap to discharge the static electricity from your body.

NOTE: You can protect against ESD and discharge static electricity from your body by touching a metal-grounded object before you interact with anything electronic, for example, an unpainted metal surface on your computer's I/O panel. When connecting a peripheral (including handheld digital assistants) to your computer, you should always ground both yourself and the peripheral before connecting it to the computer. In addition, as you work inside the computer, periodically touch a metal-grounded object to remove any static charge that your body may have accumulated.

For more information about the wrist strap and ESD wrist strap tester, see [Components of an ESD Field Service Kit](#).

- Before transporting a static-sensitive component, place it in an anti-static container or packaging.

ESD Field Service kit

The unmonitored field service kit is the most commonly used service kit. Each Field Service kit includes three main components: anti-static mat, wrist strap, and bonding wire.

 **CAUTION: It is critical to keep ESD-sensitive devices away from internal parts that are insulated and often highly charged, such as plastic heat sink casings.**

Working environment

Before the ESD Field Service kit is deployed, conduct an evaluation of the site to ensure proper setup and readiness. For example, deploying the kit for a server environment is different than for a desktop or laptop environment. Servers are typically installed in a rack within a data center; desktops or laptops are typically placed on office desks or cubicles. Always look for a large open flat work area that is free of clutter and large enough to deploy the ESD kit with additional space to accommodate the type of computer that is being repaired. The workspace should also be free of insulators that can cause an ESD event. On the work area, insulators such as styrofoam and other plastics should always be moved at least 12 inches or 30 centimeters away from sensitive parts before physically handling any hardware components.

ESD packaging

All ESD-sensitive devices must be shipped and received in static-safe packaging. Metal, static-shielded bags are preferred. However, you should always return the damaged component using the same ESD bag and packaging that the new part arrived in. The ESD bag should be folded over and taped shut and all the same foam packing material should be used in the original box that the new part arrived in. ESD-sensitive devices should be removed from packaging only at an ESD-protected work surface, and parts should never be placed on top of the ESD bag because only the inside of the bag is shielded. Always place parts in your hand, on the anti-static mat, in the computer, or inside an ESD bag.

Components of an ESD Field Service kit

The components of an ESD Field Service kit are:

- **Anti-Static Mat** – The anti-static mat is dissipative and parts can be placed on it during service procedures. When using an anti-static mat, your wrist strap should be snug and the bonding wire should be connected to the anti-static mat and to any bare metal on the computer being worked on. Once deployed properly, service parts can be removed from the ESD bag and placed directly on the anti-static mat. ESD-sensitive items are safe in your hand, on the anti-static mat, in the computer, or inside an ESD bag.
- **Wrist Strap and Bonding Wire** – If an anti-static mat is not being used, the wrist strap and bonding wire should be connected directly between your wrist and an exposed metal part of the hardware. If you are using an anti-static mat, connect the wrist strap and bonding wire to the anti-static mat to ensure protection for any hardware placed on the mat. The physical connection of the wrist strap and bonding wire between your skin, the anti-static mat, and the hardware is known as bonding. Use only Field Service kits with a wrist strap, anti-static mat, and bonding wire. Never use wireless wrist straps. Always be cautious that the internal wires of a wrist strap are prone to damage from normal wear and tear, and must be checked regularly with a wrist strap tester in order to avoid accidental ESD hardware damage. It is recommended to test the wrist strap and bonding wire at least once per week.
- **ESD Wrist Strap Tester** – The wires inside an ESD strap are prone to damage over time. When using an unmonitored ESD kit, it is recommended to test the wrist strap regularly—ideally before each service session, and at a minimum, once per week. The most reliable method for testing is with a wrist strap tester. To perform the test, connect the bonding wire of the wrist strap to the tester while wearing the strap. Press the test button to initiate the check. A green LED indicates a successful test, while a red LED and audible alarm signal a failure.

 **NOTE:** It is recommended to always use the traditional wired ESD grounding wrist strap and protective anti-static mat when servicing Dell products. In addition, it is critical to keep sensitive parts separate from all insulator parts while servicing the computer.

Transporting sensitive components

When transporting ESD sensitive components such as replacement parts or parts to be returned to Dell, it is critical to place these parts in anti-static bags for safe transport.

Lifting equipment

Adhere to the following guidelines when lifting heavy equipment:

 **CAUTION: Do not lift greater than 50 pounds. Always obtain additional resources or use a mechanical lifting device.**

1. Get a firm balanced footing. Keep your feet apart for a stable base, and point your toes out.
2. Tighten stomach muscles. Abdominal muscles support your spine when you lift, offsetting the force of the load.
3. Lift with your legs, not your back.
4. Keep the load close. The closer it is to your spine, the less force it exerts on your back.
5. Keep your back upright, whether lifting or setting down the load. Do not add the weight of your body to the load. Avoid twisting your body and back.
6. Follow the same technique in reverse to set the load down.

After working inside your computer

 **CAUTION: Leaving stray or loose screws inside your computer may severely damage your computer.**

1. Replace all screws and ensure that no stray screws remain inside your computer.
2. Connect any external devices, peripherals, or cables you removed before working on your computer.
3. Replace any media cards, discs, or any other components that you removed before working on your computer.
4. Connect your computer and all attached devices to their electrical outlets.
5. Turn on your computer.

BitLocker

When updating the BIOS on a computer with BitLocker enabled, consider the following precautions.

 **CAUTION: If BitLocker is not suspended before updating the BIOS, the BitLocker key will not be recognized the next time that you reboot the computer. You are prompted to enter the recovery key to progress, and the computer displays a prompt for the recovery key on each reboot. If the recovery key is not known, this can result in data loss or an operating system reinstall. For more information, see Knowledge Article: [updating the BIOS on Dell computers with BitLocker enabled](#).**

The installation of the following components triggers BitLocker:

- Hard disk drive or solid state drive
- System board

Information on repairability for Québec - From Dell Canada Inc. - to Quebec consumers

Dell does not guarantee the availability of replacement parts, repair services, or information necessary for maintenance or repair.

Recommended tools

The procedures in this document may require the following tools:

- Phillips screwdriver #0

- Phillips screwdriver #1
- Plastic scribe

Screw list

NOTE: When removing screws from a component, it is recommended to note the screw type and the quantity of screws, and then place them in a screw storage box. This is to ensure that the correct number of screws and correct screw type is restored when the component is replaced.

NOTE: Some computers have magnetic surfaces. Ensure that the screws are not left attached to such surfaces when replacing a component.

NOTE: Screw color may vary depending on the configuration ordered.

Table 23. Screw list



















Component	Screw type	Quantity	Screw image
Side cover	#6-32	1	
M.2 2230 solid-state drive in a single SSD configuration	M2x3.5	2	
M.2 2280 solid-state drive in a single SSD configuration	M2x3.5	1	
M.2 2230 solid-state drive in a dual SSD configuration	M2x8.5	1	
	M2x6	1	
M.2 2280 solid-state drive in a dual SSD configuration	M2x3.5	1	
Wireless card	M2x3.5	1	
External puck antenna	Captive	1	
SMA antenna module	M3x3	1	
Optional input/output module (Dual USB 3.2 Gen 2 / USB Type-C / DisplayPort / HDMI / VGA / PS2 / Serial)	Captive	1	

Table 23. Screw list (continued)

Component	Screw type	Quantity	Screw image
		1	
Optional fiber optic port module	Captive	2	
		1	
Heat sink	Captive	3	
Internal antenna module	M3x3	2	
	Captive	1	
Speaker holder	M3x5	1	
System board	M3x5	3	
	Standoff nut	1	

Major components of Dell Pro Micro QCM1255

The following image shows the major components of Dell Pro Micro QCM1255.

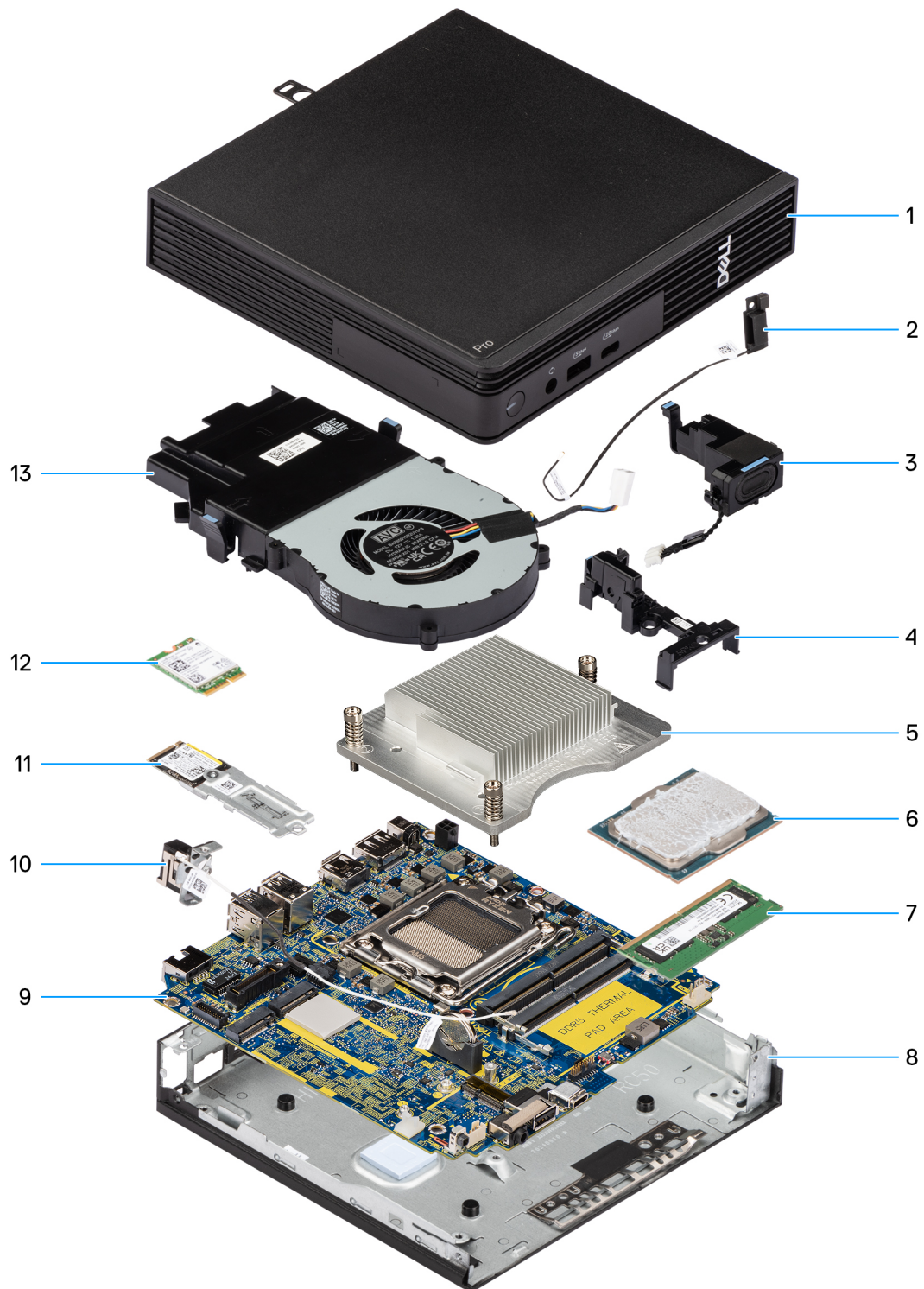



Figure 9. Major components of Dell Pro Micro QCM1255

- 1. Side cover
- 2. Internal antenna module (black cable)
- 3. Speaker
- 4. Speaker holder
- 5. Heat sink
- 6. Processor
- 7. Memory

8. Chassis
9. System board
10. Internal antenna module (white cable)
11. Solid-state drive assembly
12. Wireless card
13. Fan

 **NOTE:** Dell Technologies provides a list of components and their part numbers for the original system configuration purchased. These parts are available according to warranty coverages purchased by the customer. Contact your Dell sales representative for purchase options.

Removing and installing side cover

Removing the side cover

1. Follow the procedure in [Before working inside your computer](#).

The following images indicate the location of the side cover and provide a visual representation of the removal procedure.



Figure 10. Removing the side cover

1. Place your computer on its side with the side cover facing up.
2. Loosen the thumbscrew (6x32) that secures the side cover to the chassis.
3. Slide and lift the side cover off the chassis.

Installing the side cover

If you are replacing a component, remove the existing component before performing the installation process. The following images indicate the location of the side cover and provide a visual representation of the installation procedure.

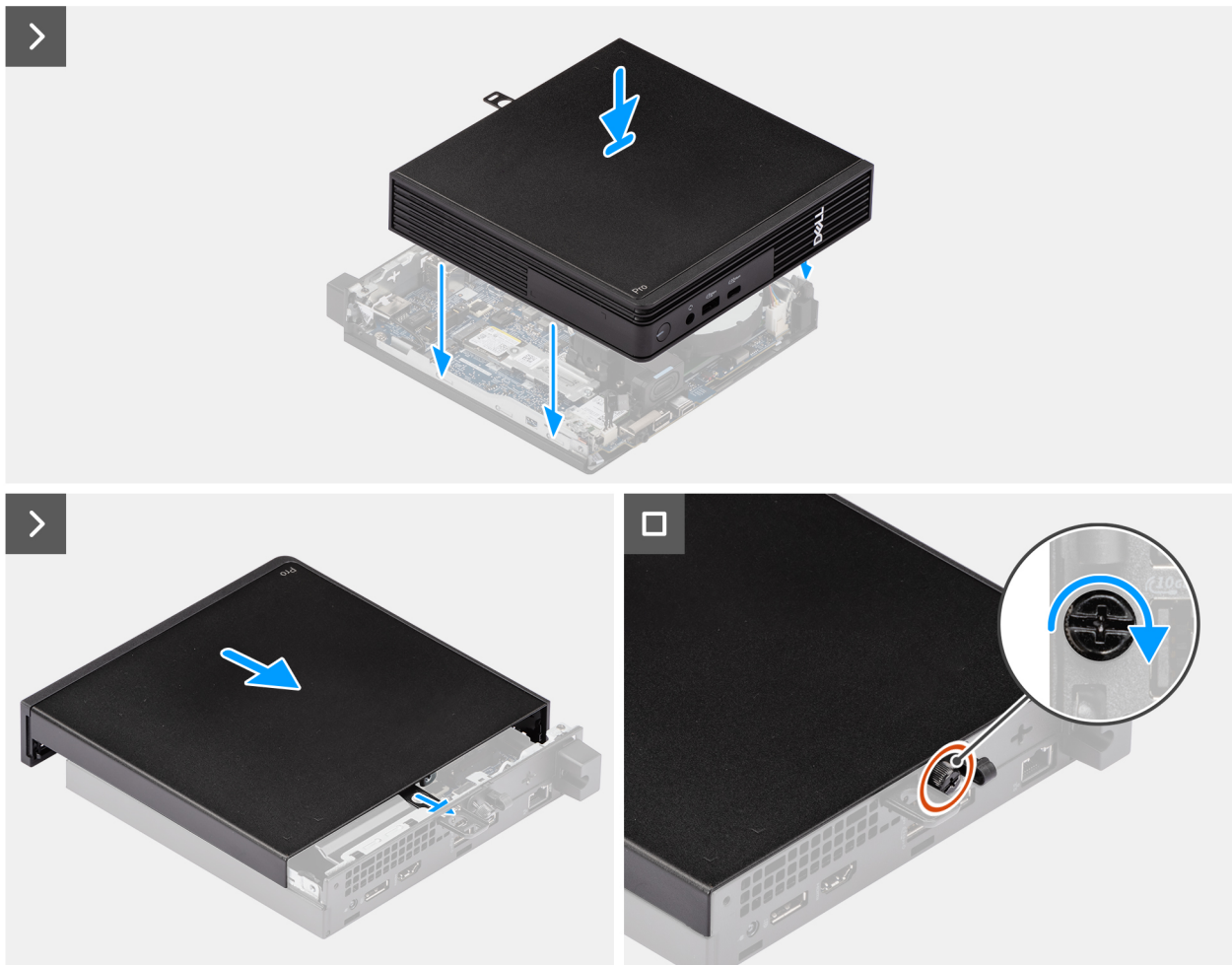

Figure 11. Installing the side cover

1. Place the side cover on the chassis by aligning the tabs on the side cover with the slots on the chassis.
2. Slide the side cover towards the rear of the computer.
3. Tighten the thumbscrew (6x32) that secures the side cover to the chassis.
1. Follow the procedure in [After working inside your computer](#).

Removing and installing coin-cell battery

Removing the coin-cell battery

CAUTION: Removing the coin-cell battery clears the CMOS and resets BIOS settings.

1. Follow the procedure in [Before working inside your computer](#).
2. Remove the [side cover](#).
3. Remove the [speaker](#).

The following images indicate the location of the coin-cell battery and provide a visual representation of the removal procedure.

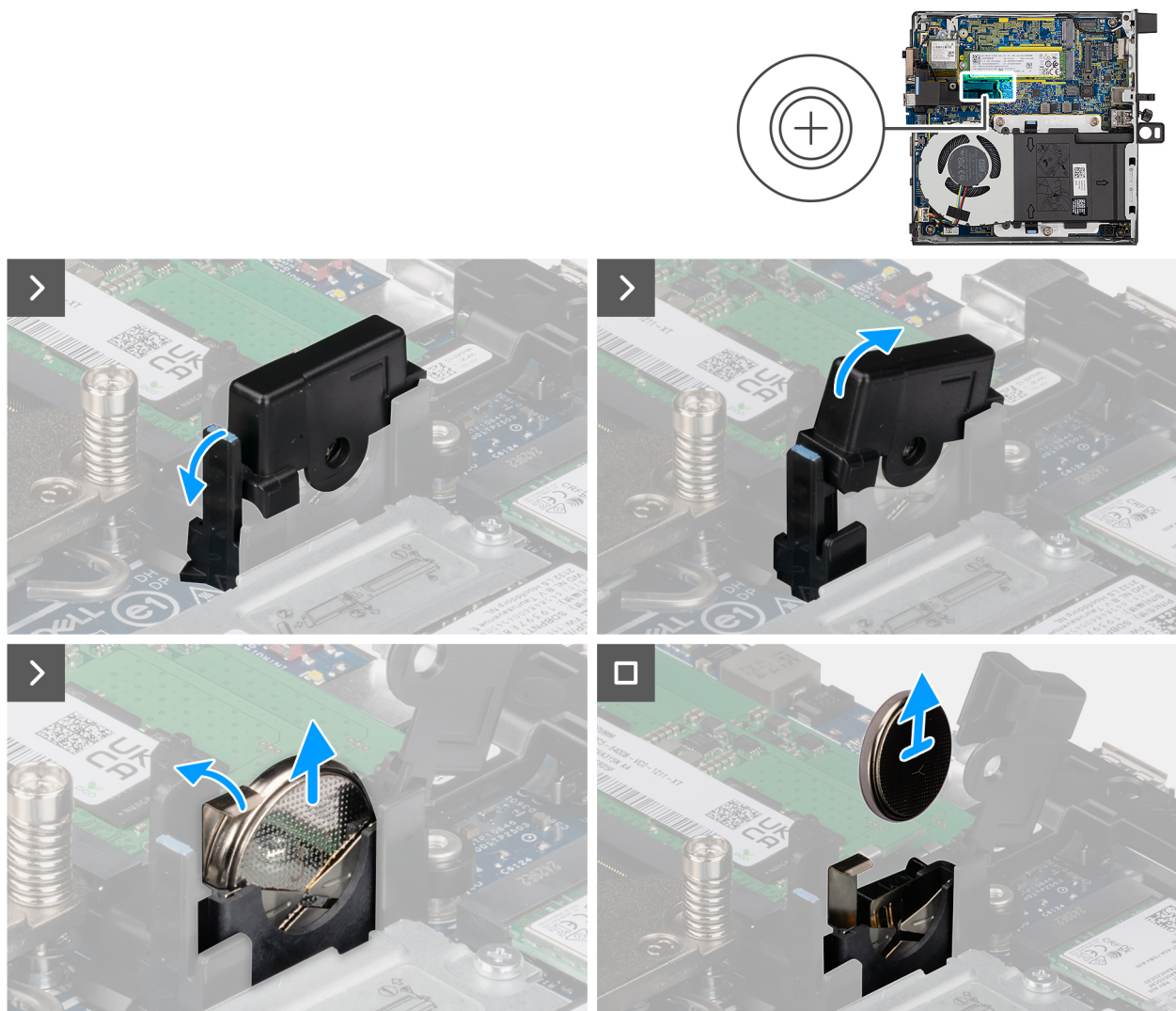

Figure 12. Removing the coin-cell battery

1. Pull the coin-cell battery-cover tab and rotate the coin-cell battery cover to access the coin-cell battery.
2. Press the coin-cell battery-release lever on the coin-cell battery socket and pull the coin-cell battery slightly upwards.
3. Lift and remove the coin-cell battery from the coin-cell battery socket.

Installing the coin-cell battery

If you are replacing a component, remove the existing component before performing the installation process.

The following images indicate the location of the coin-cell battery and provide a visual representation of the installation procedure.

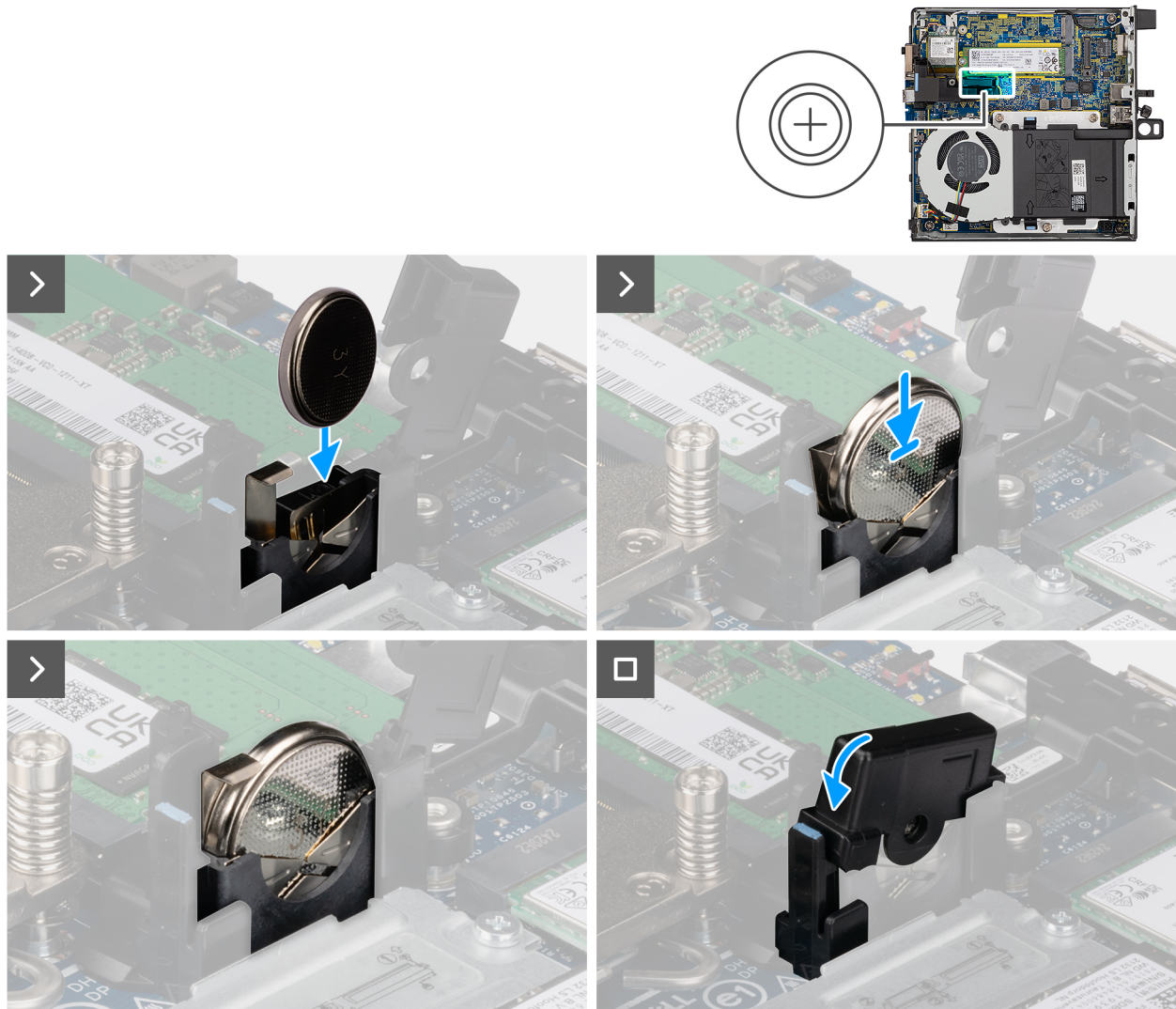

Figure 13. Installing the coin-cell battery

1. With the positive side (+) facing towards the front side of the computer, insert the coin-cell battery into the coin-cell battery socket and snap the battery into place.
 2. Rotate and press the coin-cell battery cover until it snaps into its place.
1. Install the [speaker](#).
 2. Install the [side cover](#).
 3. Follow the procedure in [After working inside your computer](#).

Removing and installing Customer Replaceable Units (CRUs)

The replaceable components in this chapter are Customer Replaceable Units (CRUs).

CAUTION: Customers can replace only the Customer Replaceable Units (CRUs) following the safety precautions and replacement procedures.

NOTE: The images in this document may differ from your computer depending on the configuration you ordered.

Speaker

Removing the speaker

1. Follow the procedure in [Before working inside your computer](#).
2. Remove the [side cover](#).

The following images indicate the location of the speaker and provide a visual representation of the removal procedure.

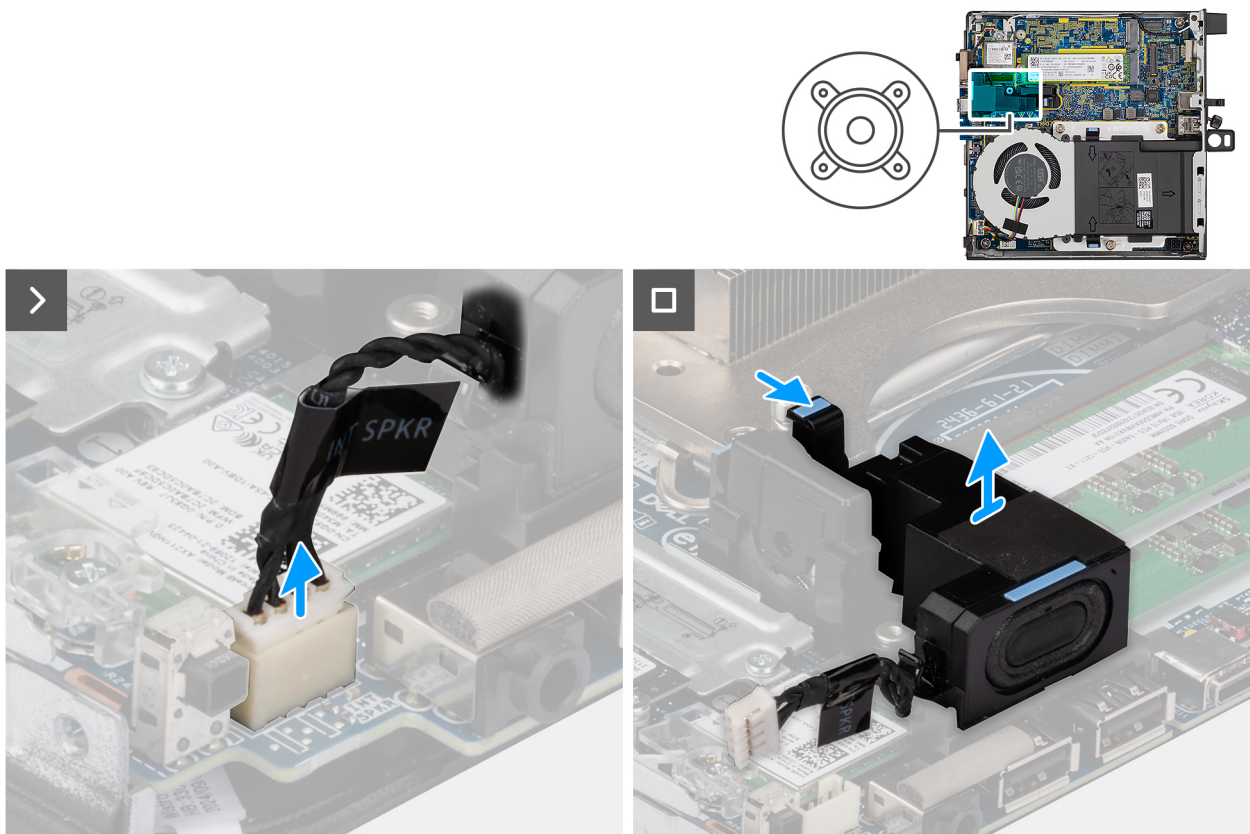

Figure 14. Removing the speaker

1. Disconnect the speaker cable from its connector (INT SPKR) on the system board.
2. Press the tab that secures the speaker to the speaker holder.

3. Lift the speaker off the bracket.

Installing the speaker

If you are replacing a component, remove the existing component before performing the installation process.

The following images indicate the location of the speaker and provide a visual representation of the installation procedure.

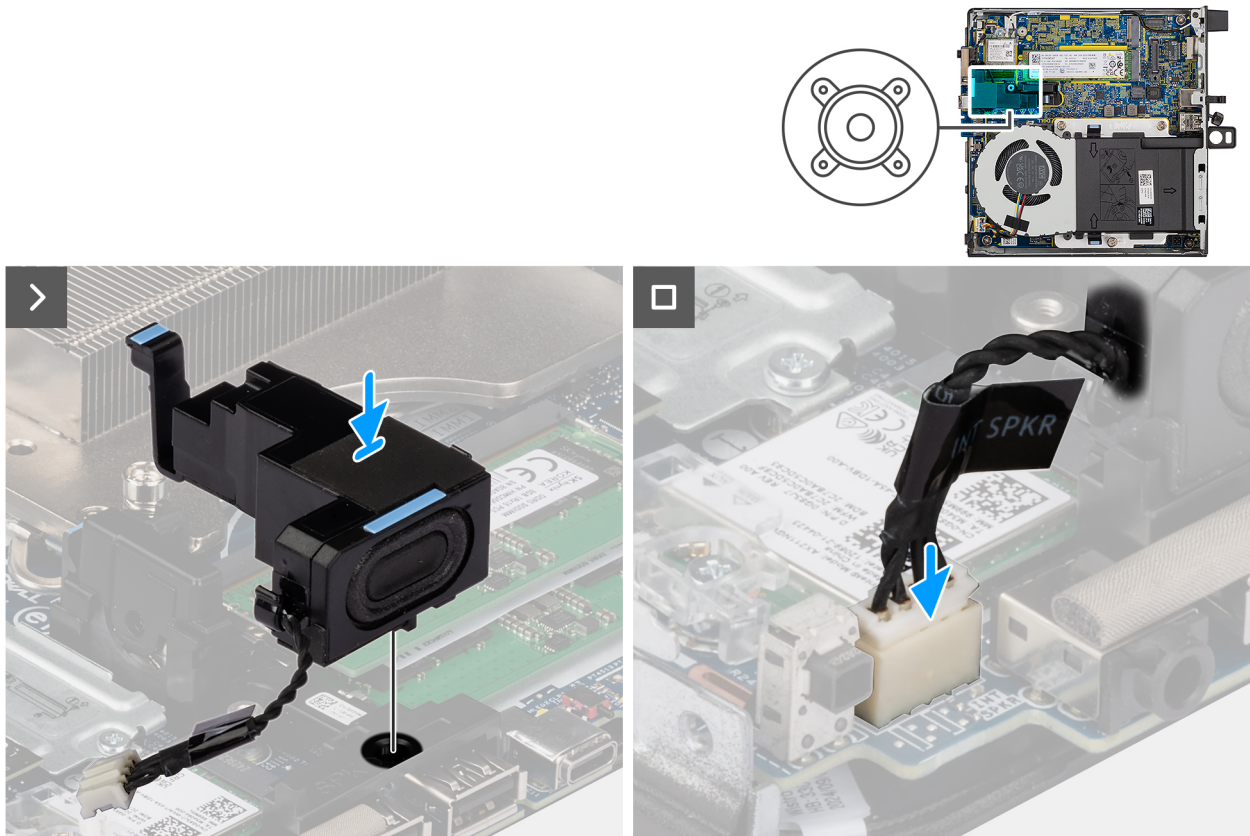

Figure 15. Installing the speaker

1. Align the tab on the speaker with its slot in the speaker holder.
 2. Place the speaker onto the speaker holder and press it downwards to snap the speaker into its place.
 3. Connect the speaker cable to its connector (INT SPKR) on the system board.
1. Install the [side cover](#).
 2. Follow the procedure in [After working inside your computer](#).

Solid state drive

NOTE: Your computer supports two SSD configurations.

- **Single SSD configuration:** One SSD is installed in either of the two slots.
- **Dual SSD configuration:** SSDs are installed in both slots.

To upgrade from a single SSD configuration to a dual configuration by adding an SSD, users must install SSD thermal pads on both SSDs to ensure optimal performance. These thermal pads must be purchased separately.

Removing the M.2 2230 solid-state drive in a single SSD configuration

1. Follow the procedure in [Before working inside your computer](#).
2. Remove the [side cover](#).

The following images indicate the location of the M.2 2230 solid-state drive and provide a visual representation of the removal procedure.

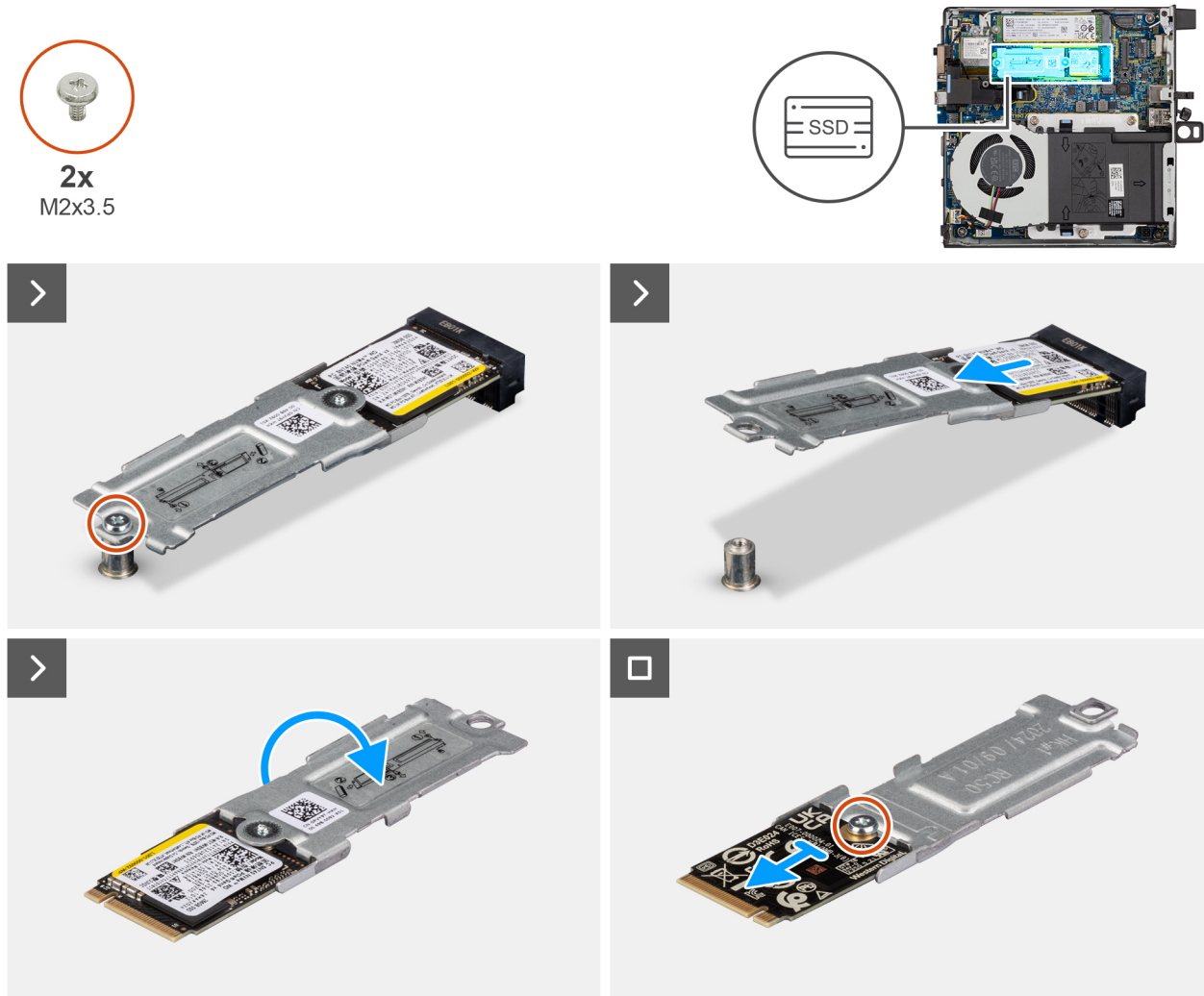

Figure 16. Removing the 2230 solid-state drive

1. Remove the screw (M2x3.5) that secures the M.2 2230 solid-state drive assembly to the system board.
2. Slide and lift the M.2 2230 solid-state drive assembly off the solid-state drive slot (M.2 PCIe SSD-0) on the system board.
3. Hold the M.2 2230 solid-state drive assembly and flip it over.
4. Remove the screw (M2x3.5) that secures the M.2 2230 solid-state drive to its bracket.

Installing the M.2 2230 solid-state drive in a single SSD configuration

If you are replacing a component, remove the existing component before performing the installation process.

- NOTE:** Ensure that a thermal pad is installed in the solid-state drive slot 1 (M.2 PCIe SSD-0) before installing the M.2 2230 solid-state drive.

The following images indicate the location of the M.2 2230 solid-state drive and provide a visual representation of the installation procedure.



2x
M2x3.5

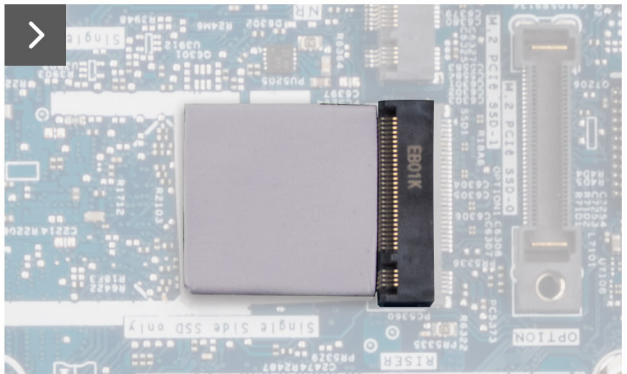
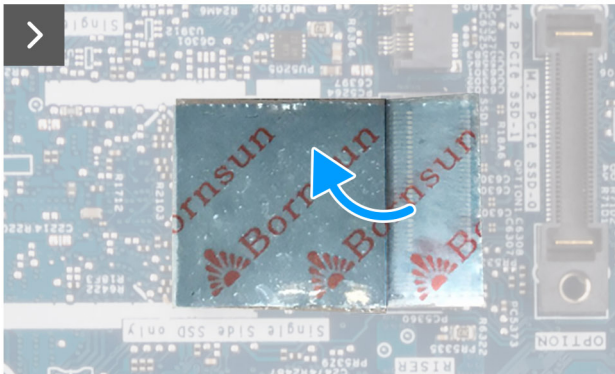
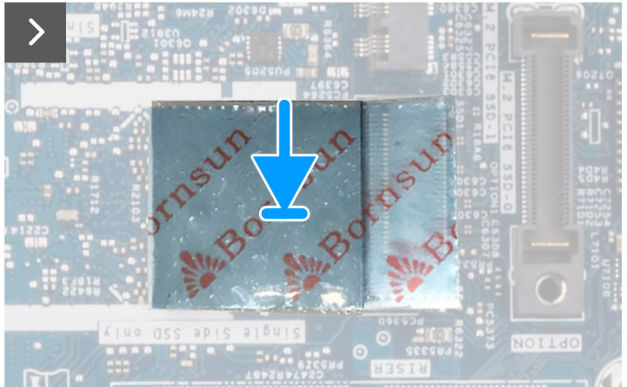
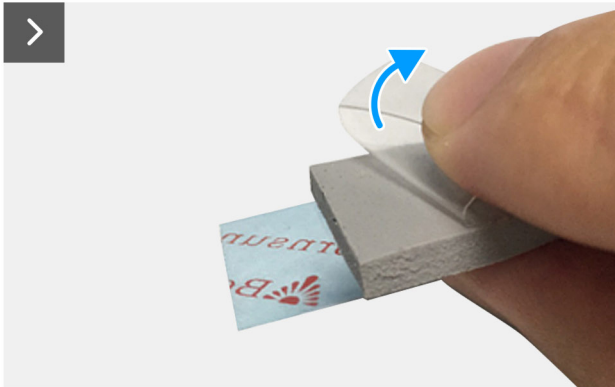
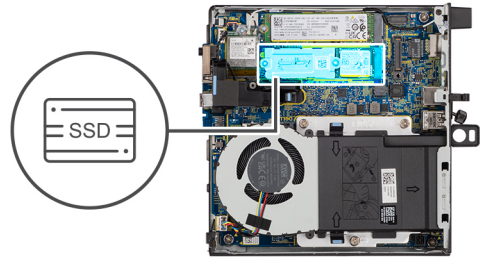

Figure 17. Installing the 2230 solid-state drive

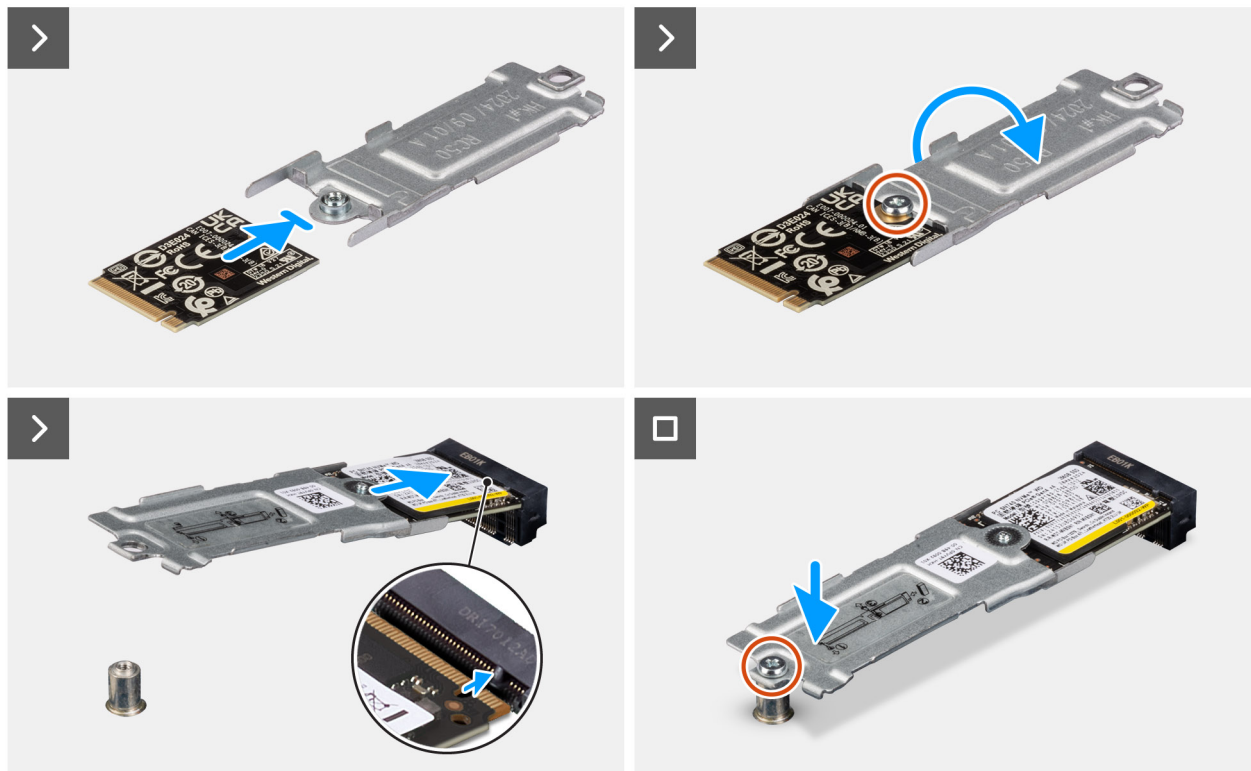

Figure 18. Installing the 2230 solid-state drive

NOTE: Step 1 to Step 5 are applicable only to the installation of the SSD thermal pad on **Slot 1 (M.2 PCIe SSD-0)** of the system board.

1. Remove the plastic liner covering the solid-state drive thermal pad, exposing the adhesive surface halfway.
 2. Place the solid-state drive thermal pad over the M.2 solid state-drive thermal pad area, ensuring accurate alignment and secure positioning.
 3. Remove the remaining plastic liner from the solid-state drive thermal pad, and carefully apply the pad to the M.2 solid-state drive thermal pad area, ensuring a secure and even bond.
 4. Use a plastic scraper to gently press and flatten the solid-state drive thermal pad onto the M.2 solid-state drive thermal pad area, ensuring a smooth and even surface for optimal adhesion.
 5. Remove the remaining plastic liner from the solid-state drive thermal pad.
 6. Align the screw hole on the M.2 2230 solid-state drive with the screw hole on the solid-state drive bracket.
 7. Replace the screw (M2x3.5) that secures the M.2 2230 solid-state drive to the solid-state drive bracket and flip over the solid-state drive assembly.
 8. Align the notch on the M.2 2230 solid-state drive with the tab on the solid-state drive slot (M.2 PCIe SSD-0).
 9. Slide the M.2 2230 solid-state drive assembly into the solid-state drive slot (M.2 PCIe SSD-0) on the system board.
 10. Replace the screw (M2x3.5) that secures the M.2 2230 solid-state drive assembly to the system board.
1. Install the [side cover](#).
 2. Follow the procedure in [After working inside your computer](#).

Removing the M.2 2280 solid-state drive in a single SSD configuration

1. Follow the procedure in [Before working inside your computer](#).
2. Remove the [side cover](#).

The following images indicate the location of the M.2 2280 solid-state drive and provide a visual representation of the removal procedure.

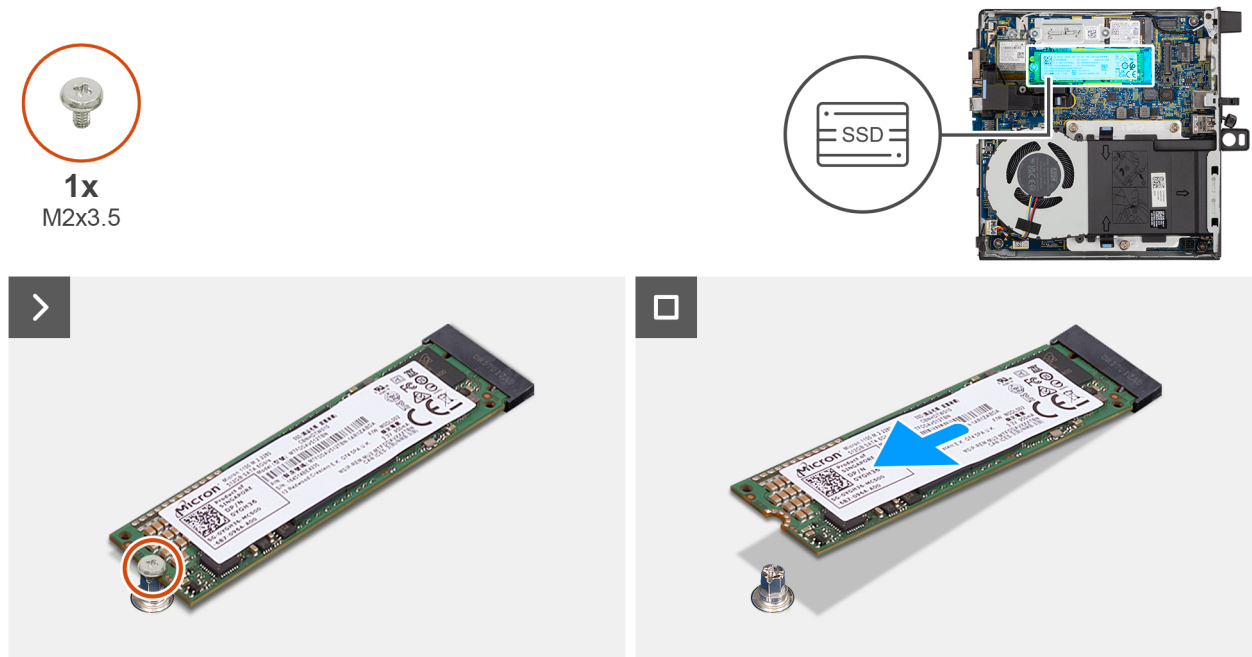

Figure 19. Removing the M.2 2280 solid-state drive

1. Remove the screw (M2x3.5) that secures the M.2 2280 solid-state drive to the system board.
2. Slide and lift the M.2 2280 solid-state drive off the solid-state drive slot (M.2 PCIe SSD-0) on the system board.

Installing the M.2 2280 solid-state drive in a single SSD configuration

If you are replacing a component, remove the existing component before performing the installation process.

NOTE: This procedure is only applicable if you are installing an M.2 2280 solid-state drive in the solid-state drive slot (M.2 PCIe SSD 0).

NOTE: Ensure that a thermal pad is installed in the solid-state drive slot 1 (M.2 PCIe SSD-0) before installing the M.2 2280 solid-state drive.

The following images indicate the location of the M.2 2280 solid-state drive and provide a visual representation of the installation procedure.



1x
M2x3.5

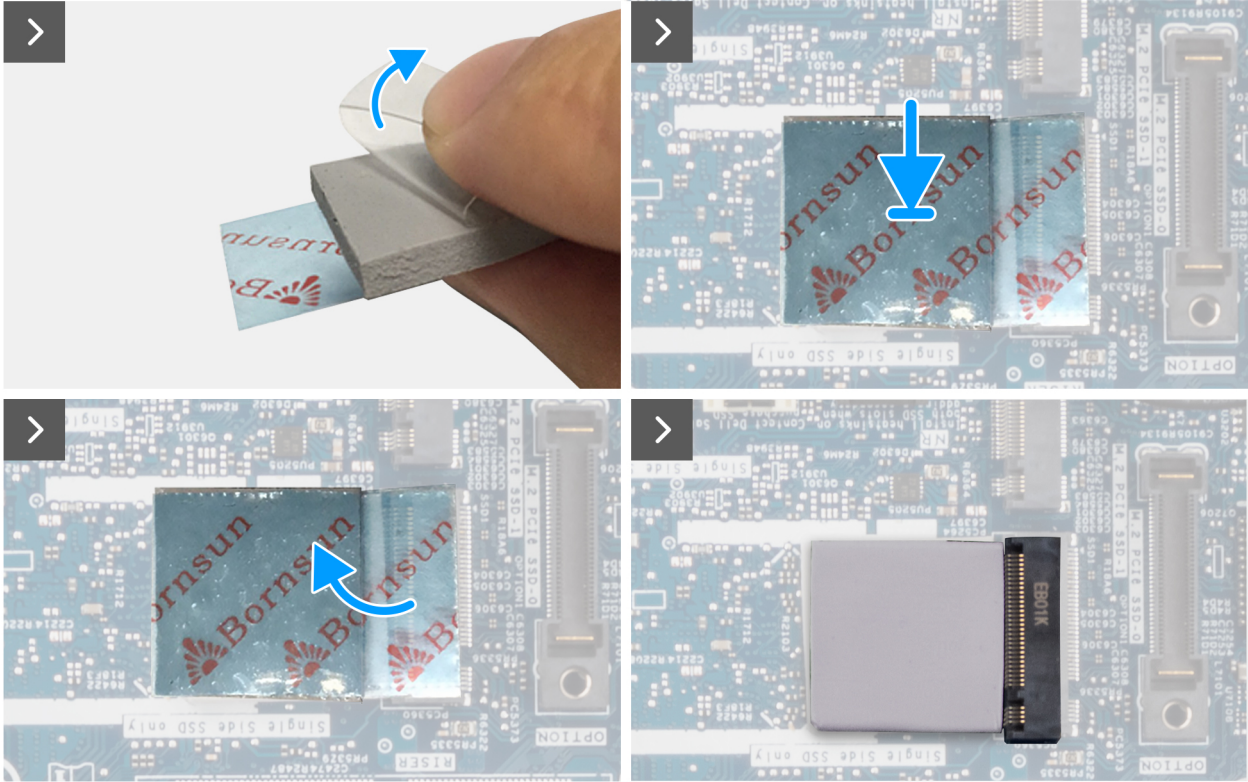
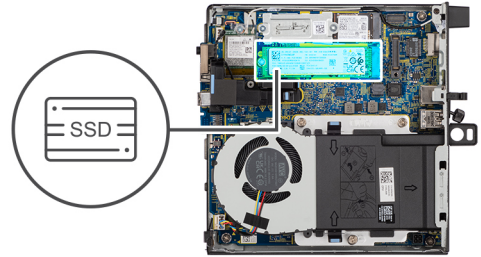

Figure 20. Installing the M.2 2280 solid-state drive

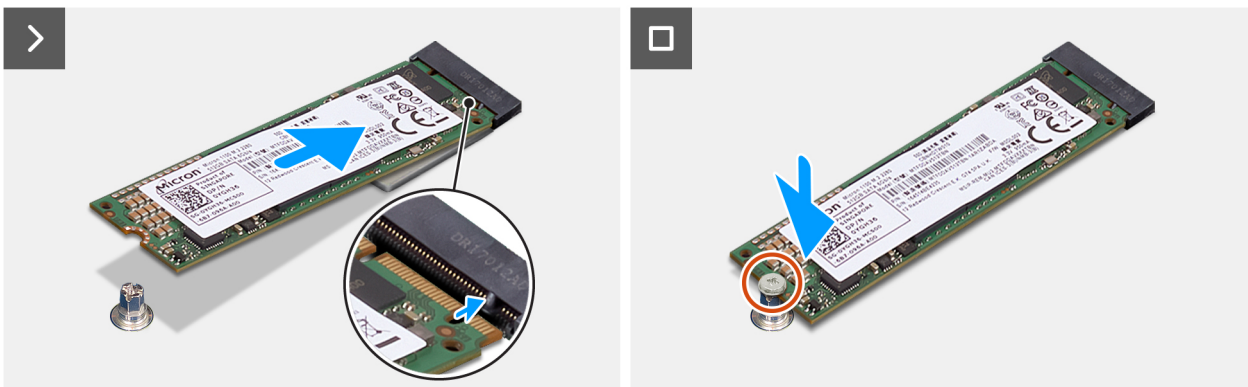

Figure 21. Installing the M.2 2280 solid-state drive

NOTE: Step 1 to Step 5 are applicable only to the installation of the SSD thermal pad on **Slot 1 (M.2 PCIe SSD-0)** of the system board.

1. Remove the plastic liner covering the solid-state drive thermal pad, exposing the adhesive surface halfway.
2. Place the solid-state drive thermal pad over the M.2 solid state-drive thermal pad area, ensuring accurate alignment and secure positioning.

3. Remove the remaining plastic liner from the solid-state drive thermal pad, and carefully apply the pad to the M.2 solid-state drive thermal pad area, ensuring a secure and even bond.
 4. Use a plastic scraper to gently press and flatten the solid-state drive thermal pad onto the M.2 solid-state drive thermal pad area, ensuring a smooth and even surface for optimal adhesion.
 5. Remove the remaining plastic liner from the solid-state drive thermal pad.
 6. Align the notch on the M.2 2280 solid-state drive with the tab on the solid-state drive slot (M.2 PCIe SSD-0).
 7. Slide the M.2 2280 solid-state drive into the solid-state drive slot (M.2 PCIe SSD-0) on the system board.
 8. Replace the screw (M2x3.5) that secures the M.2 2280 solid-state drive to the system board.
1. Install the [side cover](#).
 2. Follow the procedure in [After working inside your computer](#).

Removing the M.2 2230 solid-state drive in a dual SSD configuration

1. Follow the procedure in [before working inside your computer](#).
2. Remove the [side cover](#).

The following images indicate the location of the SSD and provide a visual representation of the removal procedure.

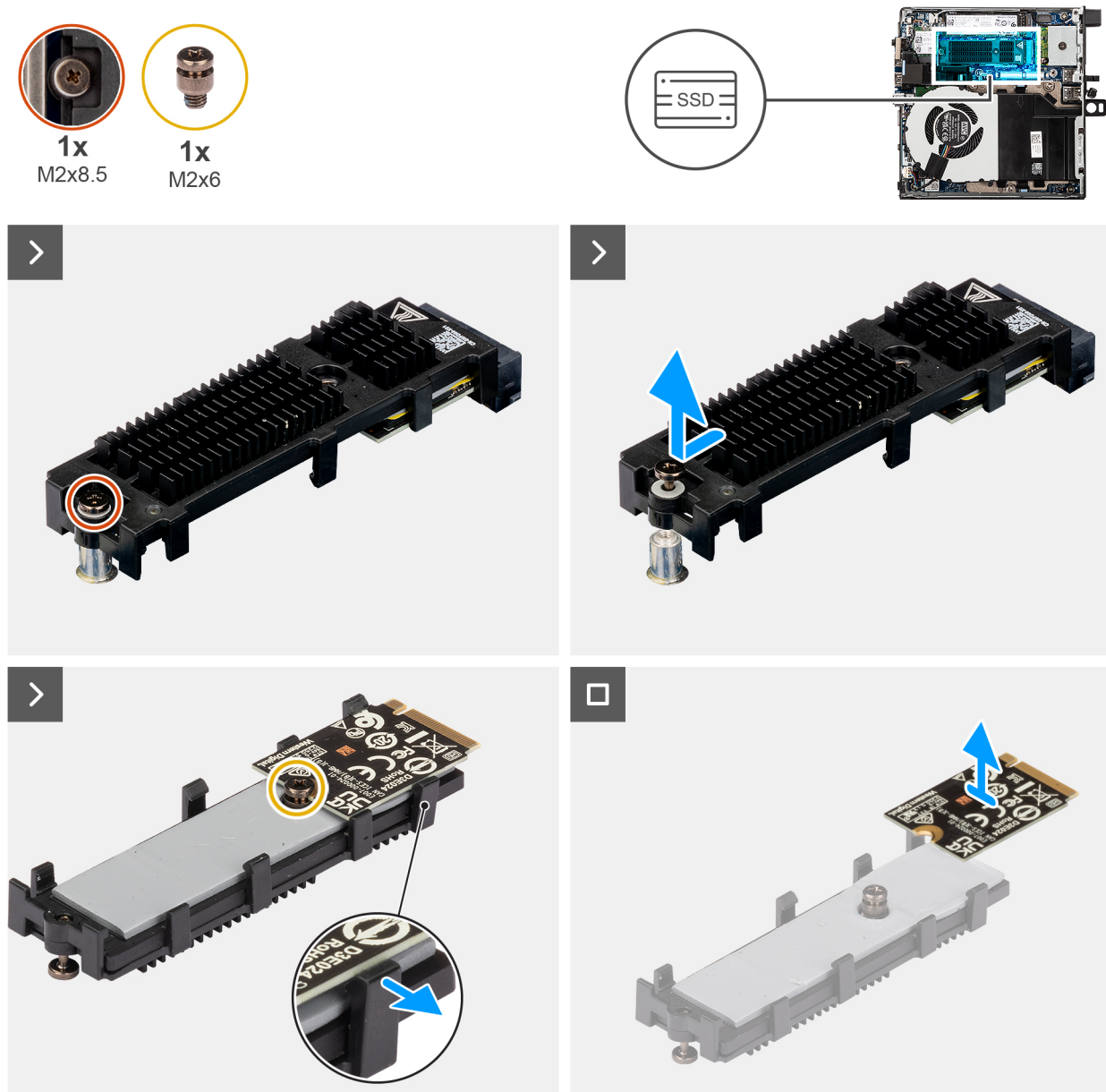

Figure 22. Removing the M.2 2230 PCIe solid state drive

1. Loosen the screw (M2x8.5) that secures the SSD-extender bracket to the system board.
2. Slide and lift the SSD-extender bracket from the system board.
3. Flip over the extender bracket.
4. Release the four snaps holding the M.2 2230 SSD card.
5. Remove the M.2 2230 SSD from the extender bracket.

NOTE: Repeat steps 1 to 5 for removing M.2 2230 SSD from slot-two, if applicable.

Installing the M.2 2230 solid-state drive in a dual SSD configuration

If you are replacing a component, remove the existing component before performing the installation procedure. The following image indicates the location of the SSD and provides a visual representation of the installation procedure.

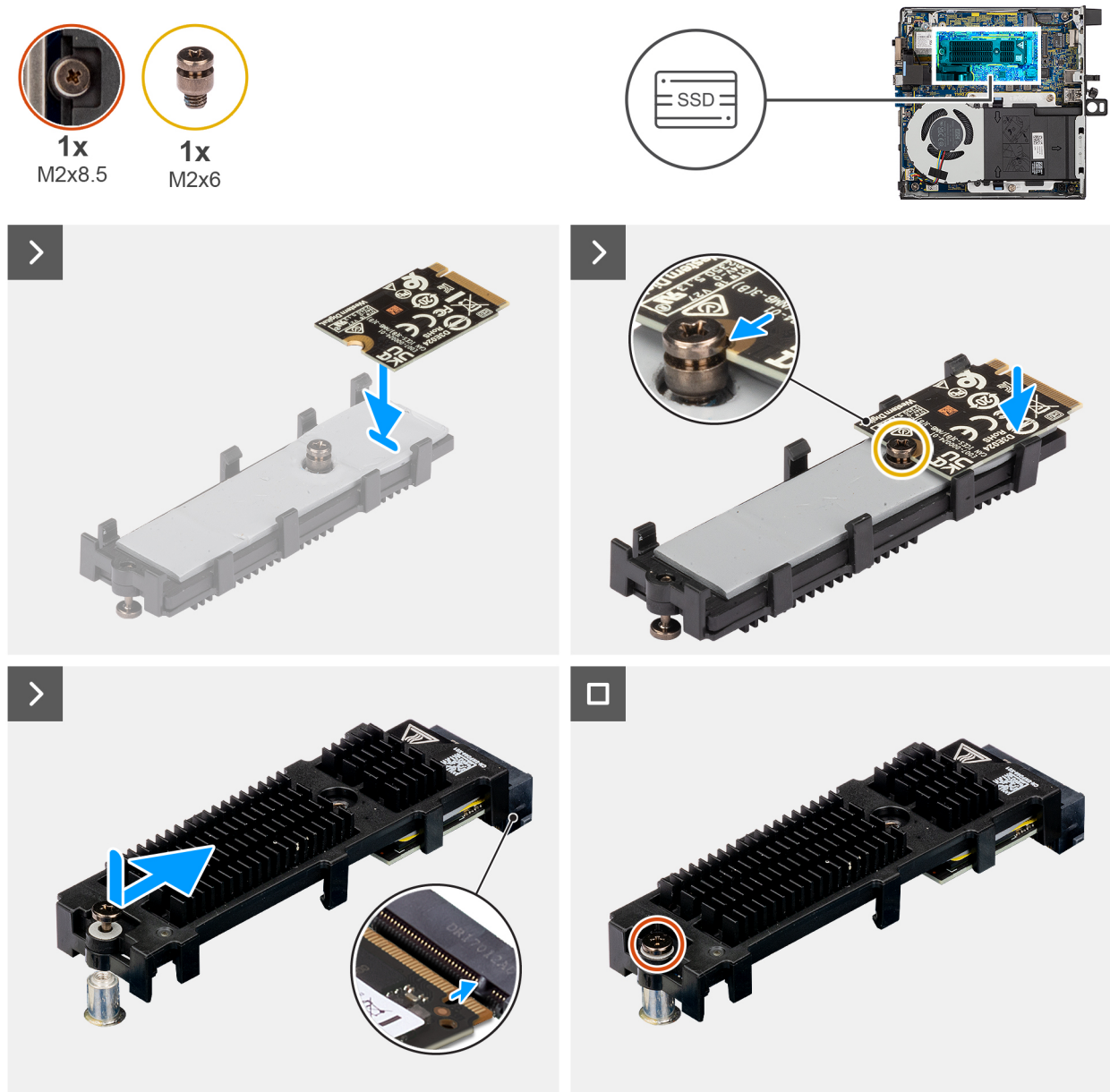

Figure 23. Installing the M.2 2230 PCIe solid state drive

1. Place the M.2 2230 SSD card on the extender bracket at a 45-degree angle.
2. Align the notch of the card with the screw (M2x6) on the extender bracket.
3. Press down until the M.2 2230 SSD card snaps into place.
4. Flip the extender bracket and align the notch with the tab on the SSD connector on the system board.
5. Insert the SSD-extender bracket at a 45-degree angle into the M.2 connector on the system board.
6. Replace the screw (M2x8.5) that secures the M.2 2230 SSD-extender bracket to the system board.

NOTE: Repeat the above steps for installing the M.2 2230 SSD in the other slot, if applicable.

1. Install the [side cover](#).
2. Follow the procedure in [after working inside your computer](#).

Removing the M.2 2280 solid-state drive in a dual SSD configuration

1. Follow the procedure in [Before working inside your computer](#).
2. Remove the [side cover](#).

The following images indicate the location of the SSD and provide a visual representation of the removal procedure.

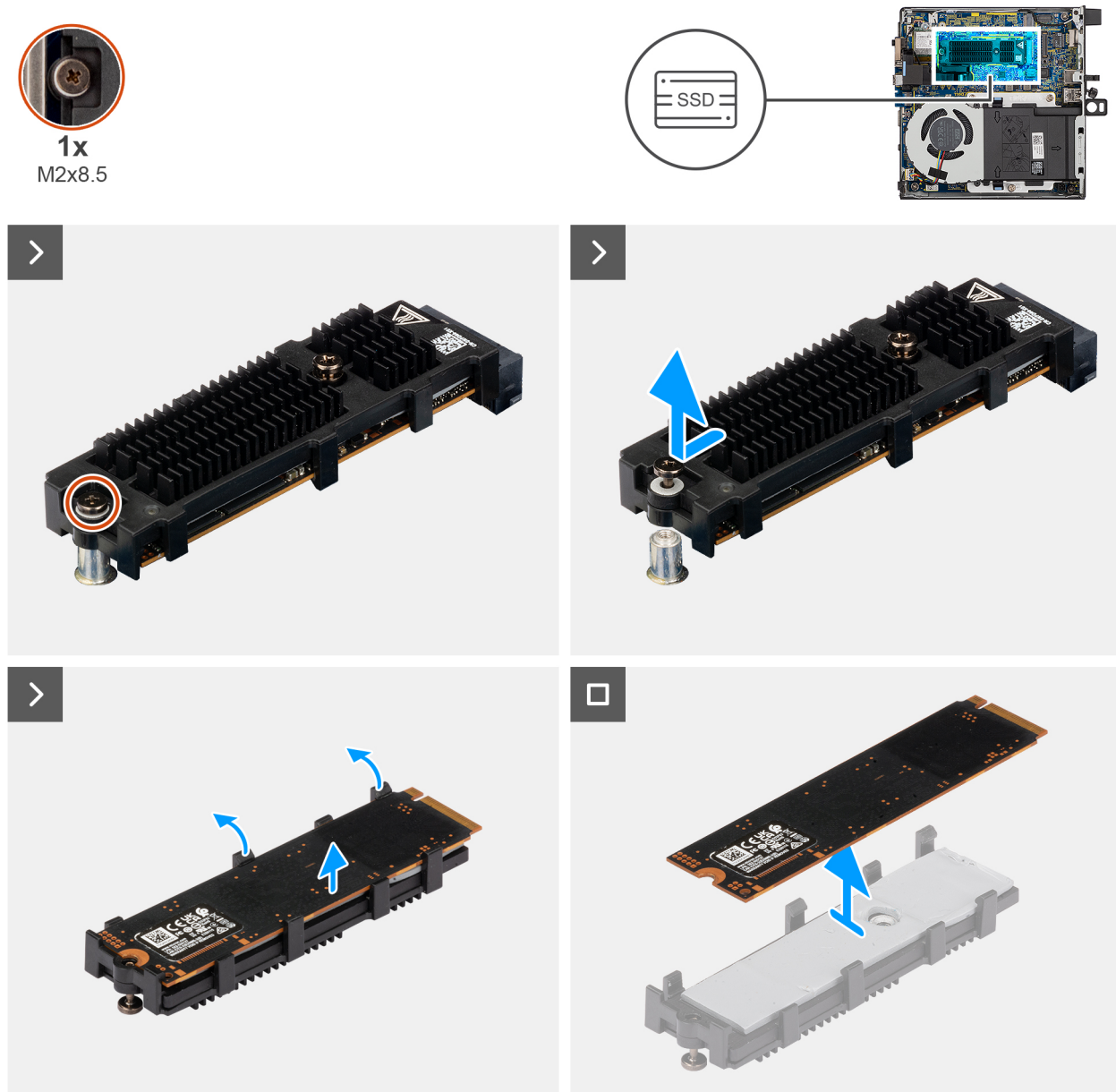

Figure 24. Removing the M.2 2280 PCIe solid state drive

1. Loosen the screw (M2x8.5) that secures the SSD-extender bracket to the system board.
2. Slide and lift the SSD-extender bracket from the system board.
3. Flip over the bracket and remove the M.2 2280 SSD from the extender bracket.

Installing the M.2 2280 solid-state drive in a dual SSD configuration

If you are replacing a component, remove the existing component before performing the installation procedure. The following image indicates the location of the SSD and provides a visual representation of the installation procedure.

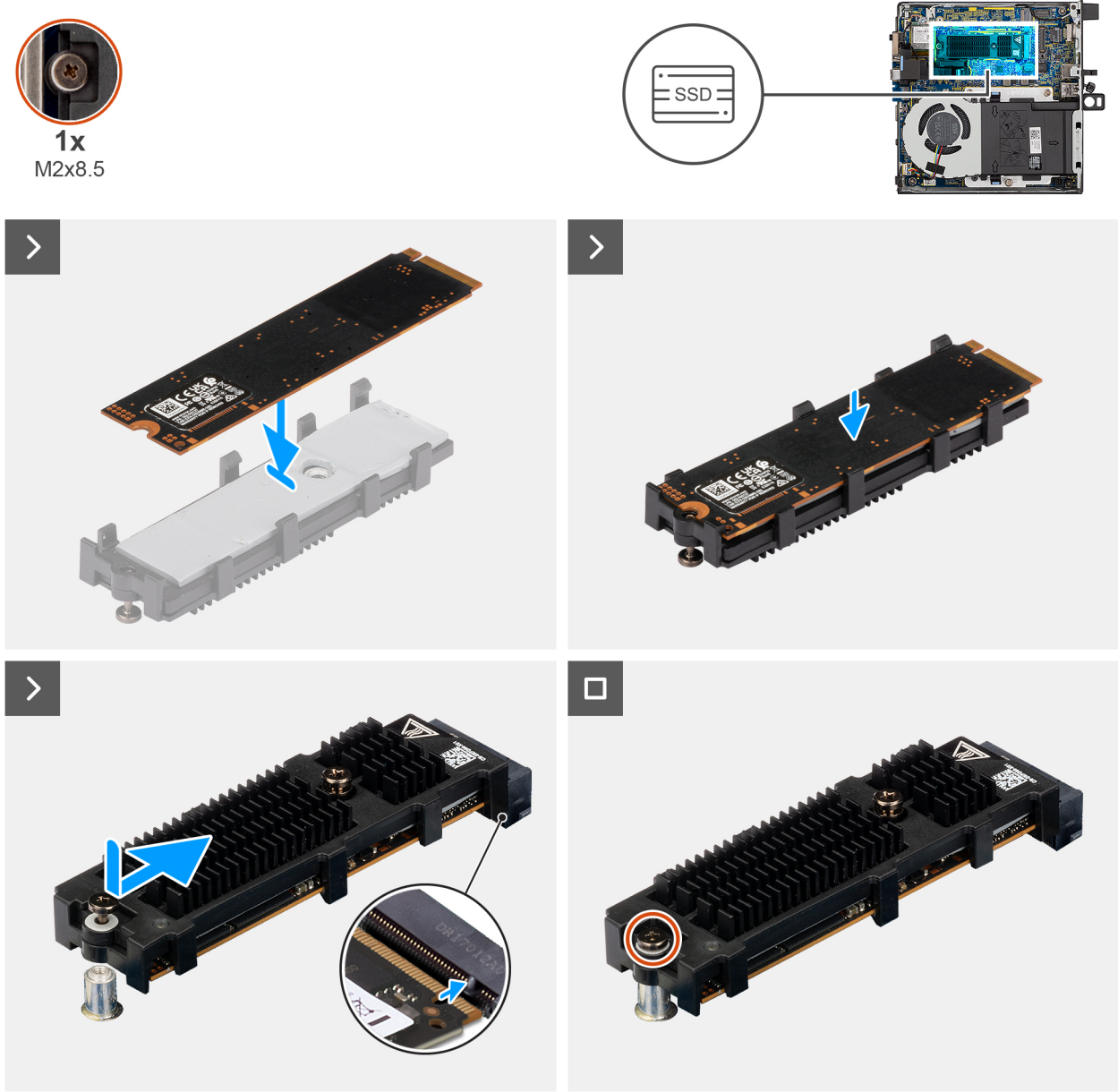

Figure 25. Installing the M.2 2280 PCIe solid state drive

1. Place the M.2 2280 SSD on the SSD-extender bracket.
 2. Flip over the bracket and align the notch with the tab on the SSD connector on the system board.
 3. Insert the SSD-extender bracket at a 45-degree angle into the M.2 connector on the system board.
 4. Replace the screw (M2x8.5) that secures the M.2 2280 SSD-extender bracket to the system board.
1. Install the [side cover](#).
 2. Follow the procedure in [after working inside your computer](#).

Wireless card

Removing the wireless card

1. Follow the procedure in [Before working inside your computer](#).
2. Remove the [side cover](#).

The following images indicate the location of the wireless card and provide a visual representation of the removal procedure.

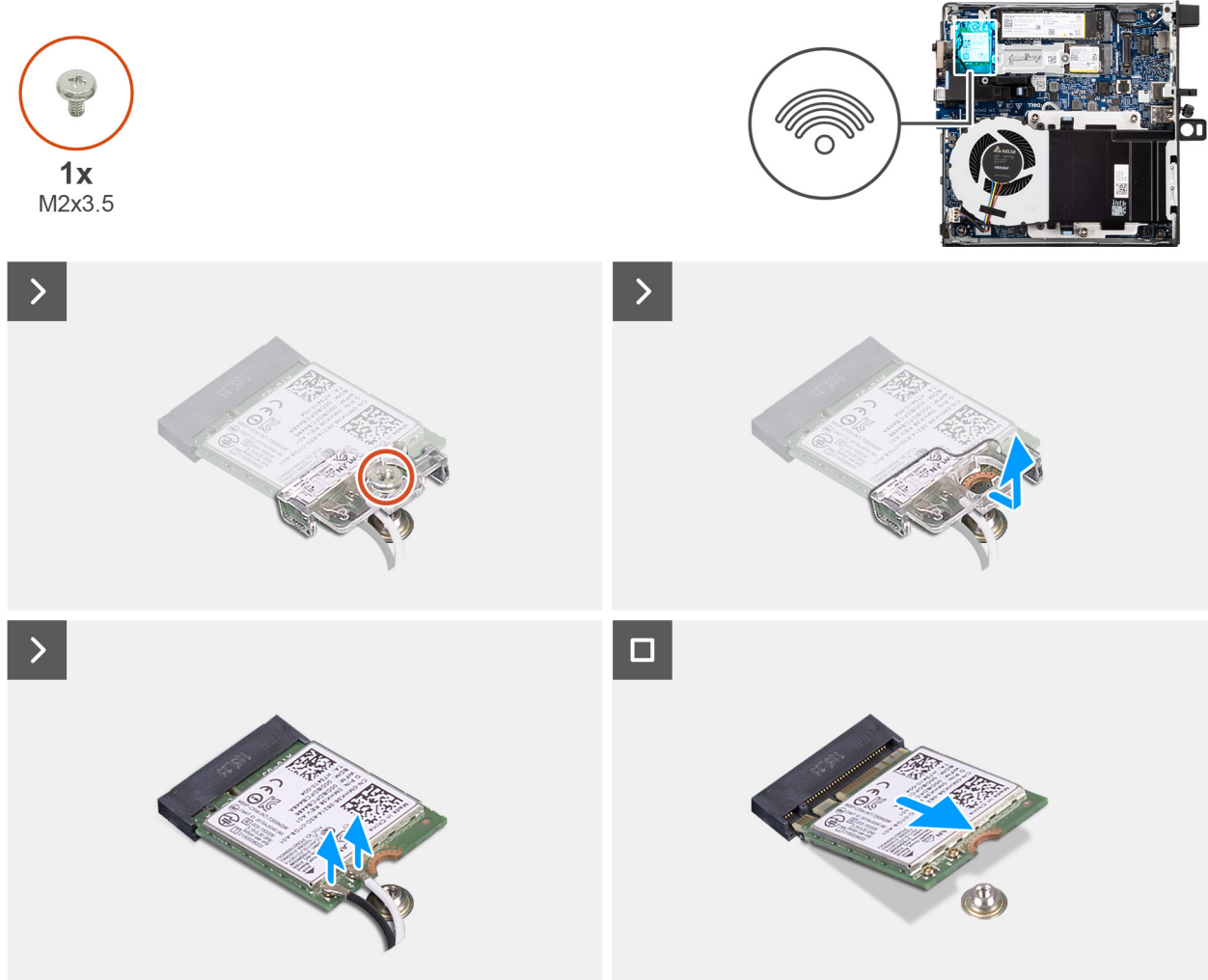

Figure 26. Removing the wireless card

1. Remove the screw (M2x3.5) that secures the wireless-card bracket to the wireless card.
2. Lift the wireless-card bracket off the wireless card.
3. Disconnect the antenna cables from the connectors on the wireless card.
4. Slide and remove the wireless card from the wireless-card slot (M.2 WLAN).

Installing the wireless card

If you are replacing a component, remove the existing component before performing the installation process.

The following images indicate the location of the wireless card and provide a visual representation of the installation procedure.



1x
M2x3.5



Figure 27. Installing the wireless card

1. Connect the antenna cables to the connectors on the wireless card.

Table 24. Antenna-cable color scheme

Connector on the wireless card	Antenna-cable color	Silkscreen marking	
Main	White	MAIN	△ (white triangle)
Auxiliary	Black	AUX	▲ (black triangle)

2. Align the notch on the wireless card with the tab on the wireless-card slot (M.2 WLAN).
 3. Slide the wireless card at an angle into the wireless-card slot (M.2 WLAN).
 4. Place the wireless-card bracket on the wireless card.
 5. Replace the screw (M2x3.5) that secures the wireless-card bracket to the wireless card.
1. Install the [side cover](#).
 2. Follow the procedure in [After working inside your computer](#).

Fan

Removing the fan

1. Follow the procedure in [Before working inside your computer](#).
2. Remove the [side cover](#).

The following images indicate the location of the fan and provide a visual representation of the removal procedure.

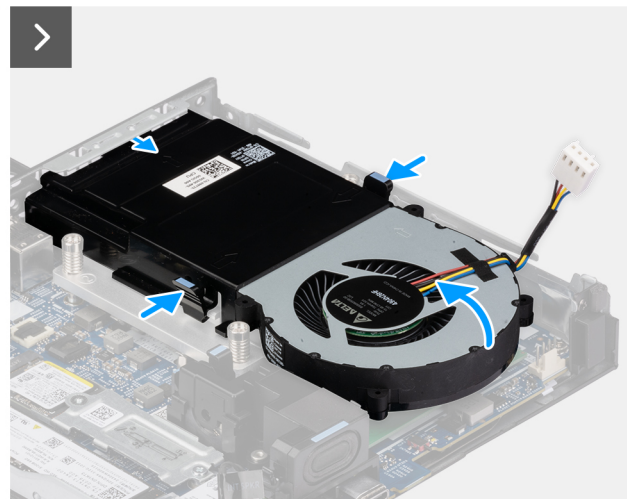
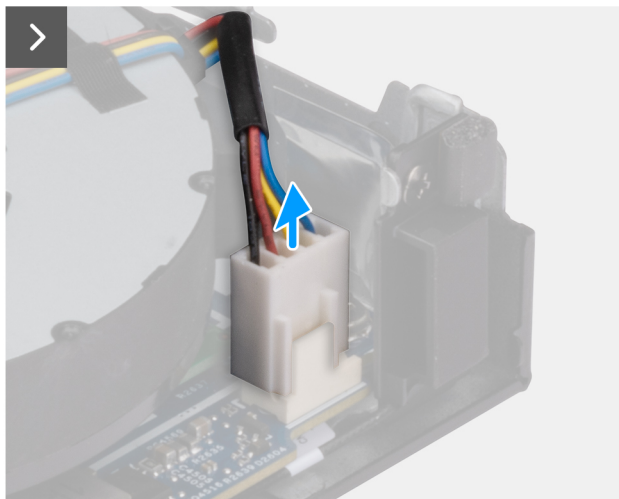
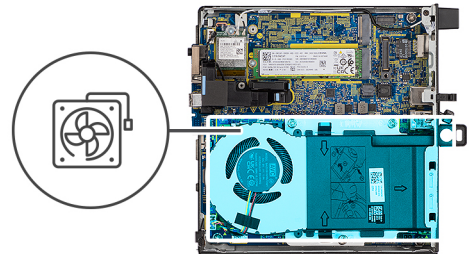

Figure 28. Removing the fan

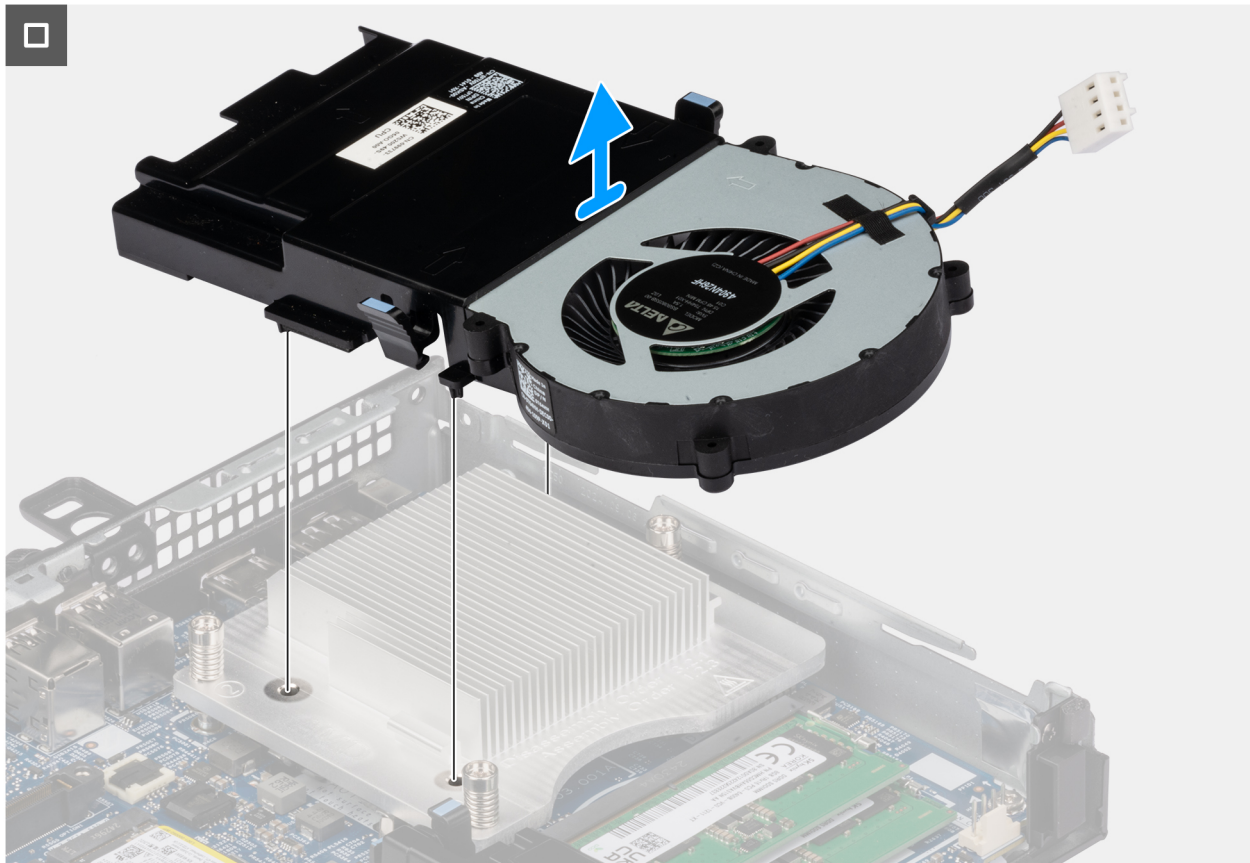

Figure 29. Removing the fan

1. Disconnect the fan cable from its connector (FAN CPU) on the system board.
2. Grip the tabs on the fan and lift it upward, holding it at the desired angle.
3. Slide the fan outwards and remove the fan away from the chassis.

Installing the fan

If you are replacing a component, remove the existing component before performing the installation process.

The following images indicate the location of the fan and provide a visual representation of the installation procedure.

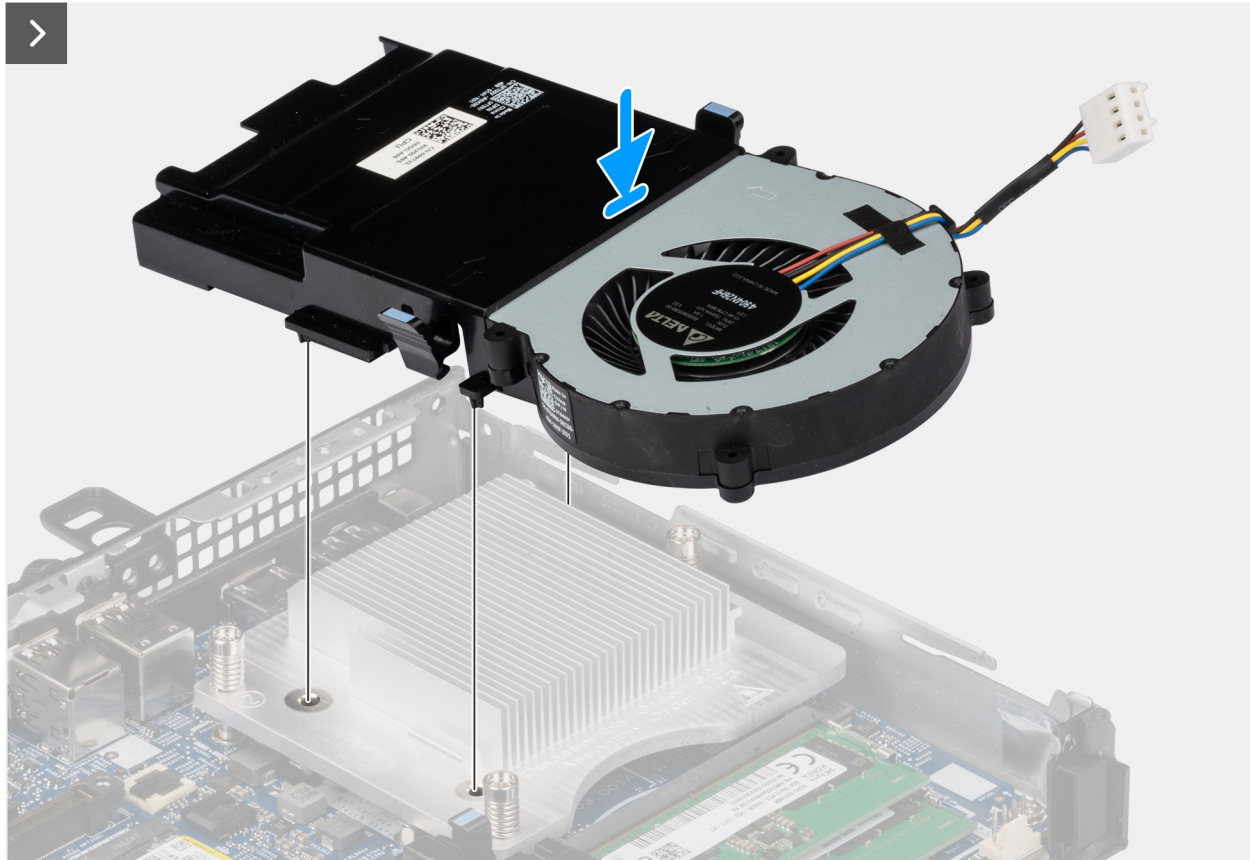
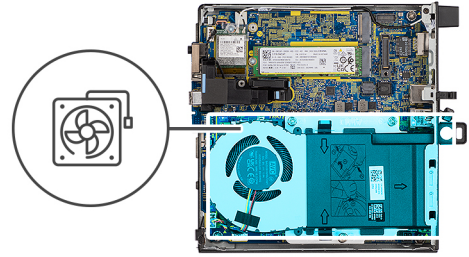

Figure 30. Installing the fan

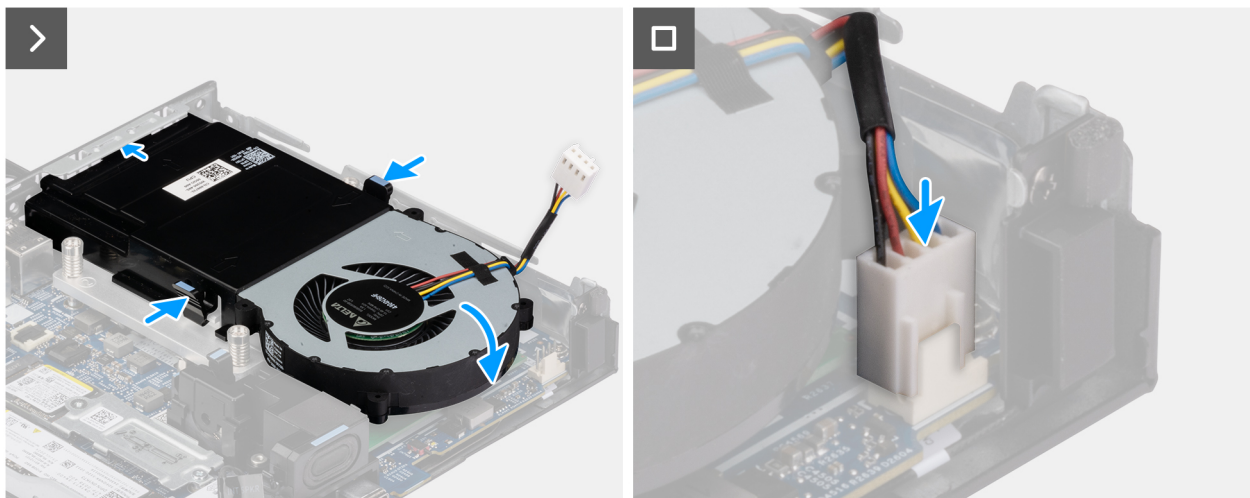

Figure 31. Installing the fan

1. Slide the fan at a certain angle into its slot on the chassis.

2. Press the fan downwards until it snaps into place.

NOTE: Ensure that the tabs are snapped into position on the heat sink.

3. Connect the fan cable to its connector (FAN CPU) on the system board.

1. Install the [side cover](#).
2. Follow the procedure in [After working inside your computer](#).

Memory

Removing the memory module

1. Follow the procedure in [Before working inside your computer](#).
2. Remove the [side cover](#).
3. Remove the [fan](#).

The following images indicate the location of the memory modules and provide a visual representation of the removal procedure.

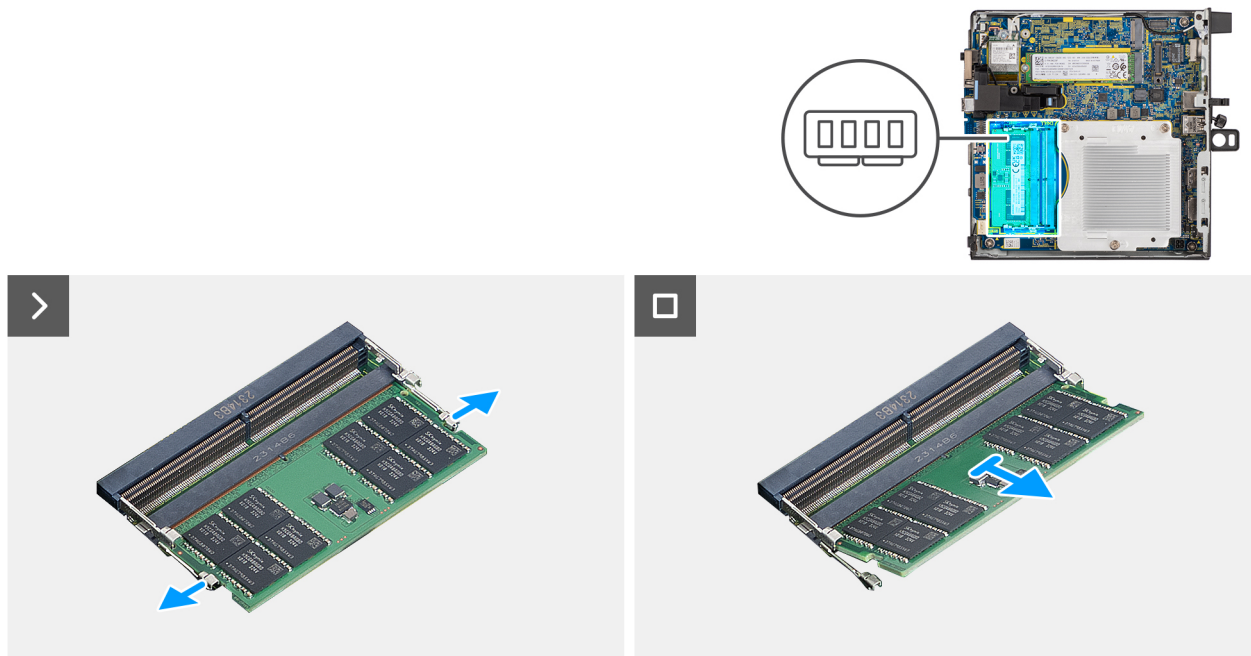

Figure 32. Removing the memory module

1. Carefully spread apart the securing-clips on each end of the memory-module slot (DIMM1 or DIMM2).
2. Grasp the memory module near the securing clip, and then gently ease the memory module out of the memory-module slot.

CAUTION: To prevent damage to the memory module, hold the memory module by the edges. Do not touch the components on the memory module.

NOTE: Repeat **Step 1** and **Step 2** to remove any other memory modules installed in your computer.

NOTE: Note the slot and the orientation of the memory module in order to replace it in the correct slot.

Installing the memory module

If you are replacing a component, remove the existing component before performing the installation process.

NOTE: The DDR5 thermal pad is required if you are installing 64 GB memory in your computer.

The following images indicate the location of the memory modules and provide a visual representation of the installation procedure.

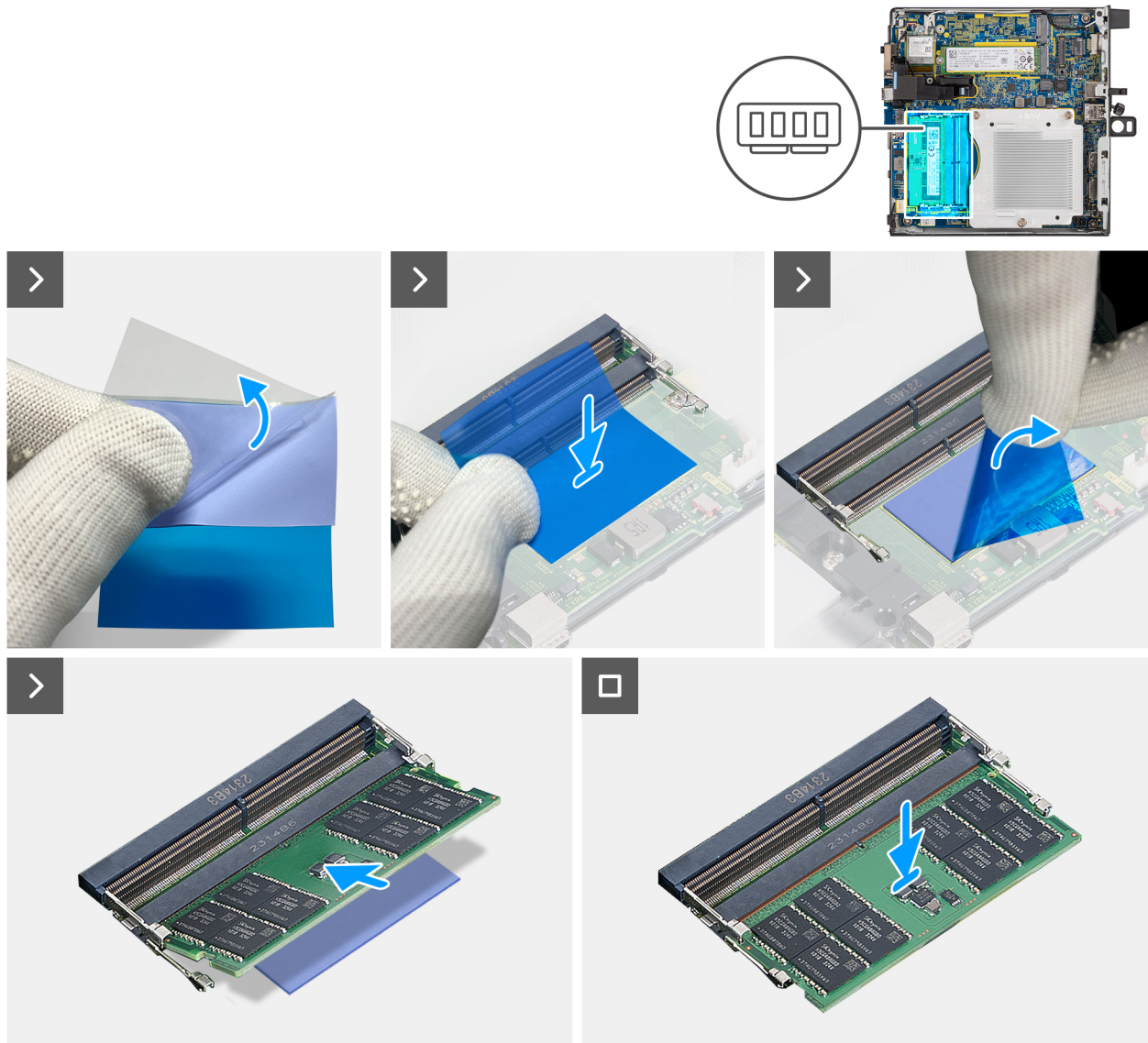

Figure 33. Installing the memory module

NOTE: Step 1 to Step 5 are applicable when installing the DDR5 thermal pad.

1. Peel back the backing of the DDR5 thermal pad halfway.
2. Align the DDR5 thermal pad over the DDR5 thermal pad area.
 - NOTE:** Ensure the corners of the DDR5 thermal pad are aligned to the corners of the DDR5 thermal pad area.
3. Peel the rest of the backing off the DDR5 thermal pad and paste the DDR5 thermal pad onto the DDR5 thermal pad area.
4. Flatten the DDR5 thermal pad with a plastic scrapper to ensure proper adhesion.
5. Peel off the protective layer from the DDR5 thermal pad.
6. Align the notch on the memory module with the tab on the memory-module slot (DIMM1 or DIMM2).
7. Press down on the memory module until the memory module snaps into position and the securing clips lock in place.

CAUTION: To prevent damage to the memory module, hold the memory module by the edges. Do not touch the components on the memory module.

NOTE: Repeat Step 6 and Step 7 when installing more than one memory module in your computer.

1. Install the [fan](#).
2. Install the [side cover](#).
3. Follow the procedure in [After working inside your computer](#).

External puck antenna

Removing external puck antenna

1. Follow the procedure in [before working inside your computer](#).

The following images indicate the location of external puck antenna and provide a visual representation of the removal procedure.

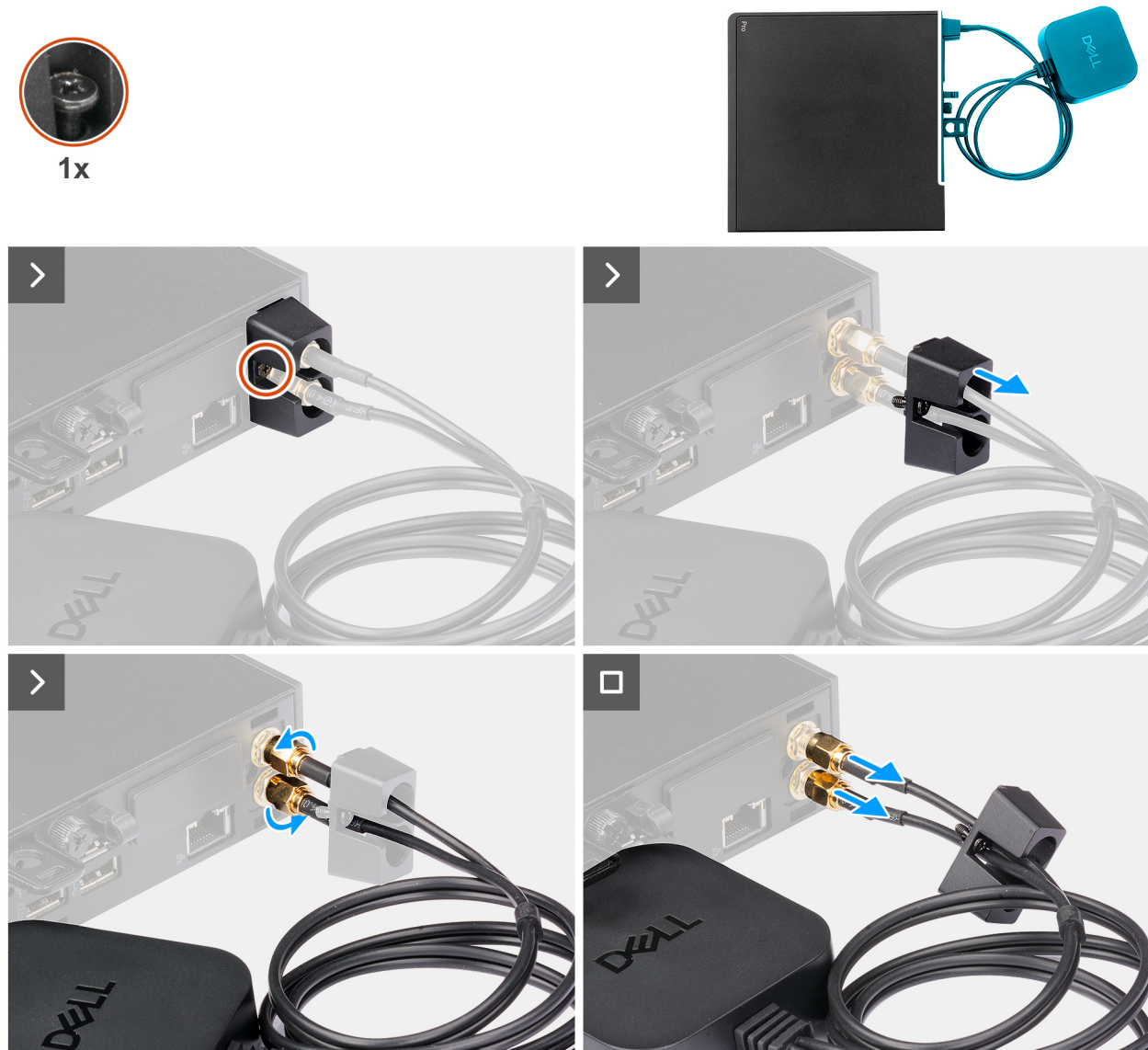

Figure 34. Removing external puck antenna

1. Loosen the captive screw that secures the puck antenna cover to the chassis.
2. Remove the puck antenna cover to access the bolts on the puck antenna cable.
3. Loosen the bolts on the puck antenna cable.
4. Disconnect the puck antenna cable from the SMA antenna connector on the chassis.

Installing external puck antenna module

If you are replacing a component, remove the existing component before performing the installation procedure.

The following images indicate the location of external puck antenna and provide a visual representation of the removal procedure.



Figure 35. Installing external puck antenna

1. Align and connect the puck antenna cables to the SMA antenna connectors on the chassis.
2. Tighten the bolts on the puck antenna cable to secure the external puck antenna to the chassis.
3. Slide and push the puck antenna cover into its slots until it clicks into its place.
4. Tighten the captive screw to secure the puck antenna cover to the chassis.
1. Follow the procedure in [after working inside your computer](#).

SMA antenna module

Removing SMA antenna module

1. Follow the procedure in [before working inside your computer](#).
2. Remove the [external puck antenna](#), if applicable.
3. Remove the [side cover](#).
4. Remove the [wireless card](#).

The following images indicate the location of SMA antenna module and provide a visual representation of the removal procedure.

NOTE: To upgrade to an SMA antenna, the internal antenna (white cable) must be removed.



1x
M3x3

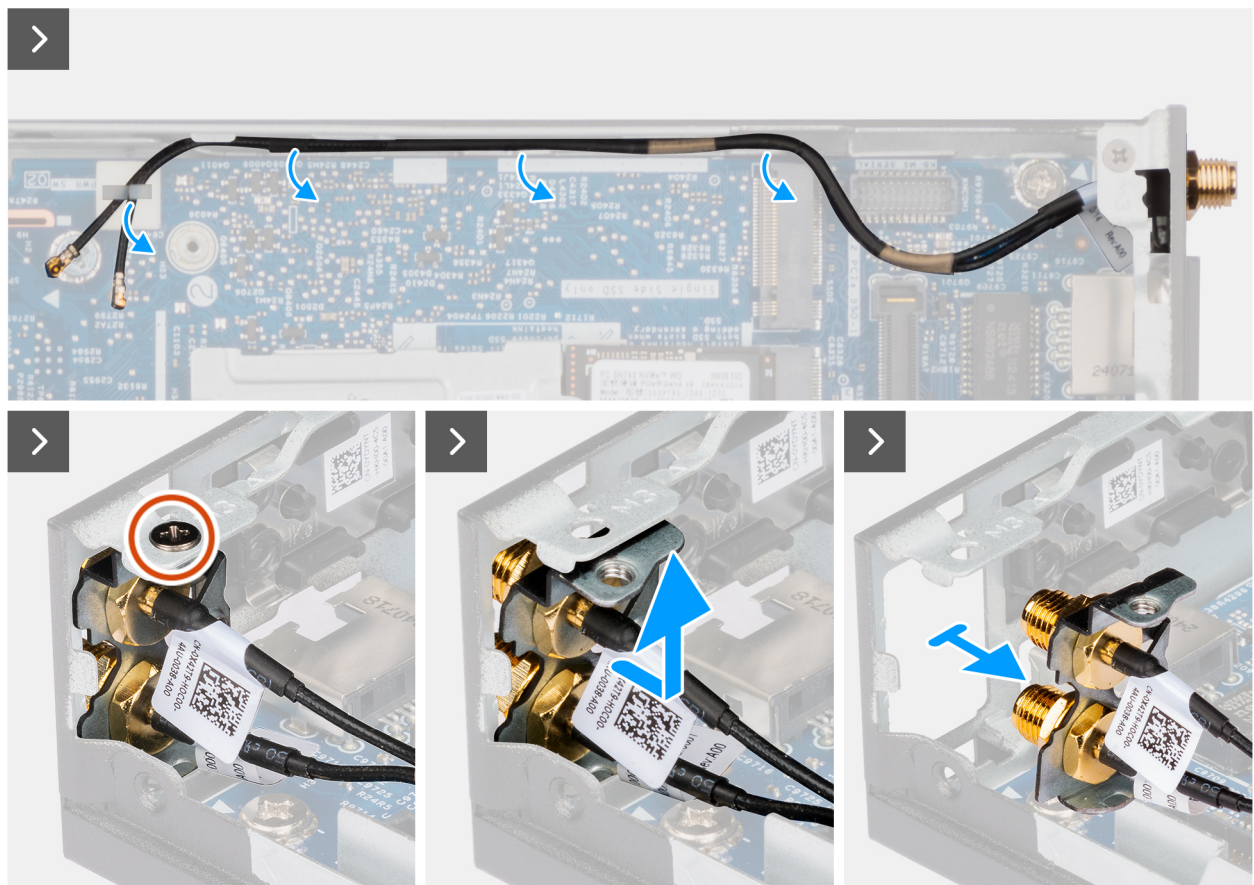

Figure 36. Removing SMA antenna

1. Remove the SMA antenna module cables from the routing guides on the chassis.
2. Remove the screw (M3x3) that secures the SMA antenna module to the chassis.
3. Push the SMA antenna module inward through the opening on the back of the chassis, and then lift it upward and away from the mounting points.

Installing SMA antenna module

If you are replacing a component, remove the existing component before performing the installation procedure.

The following images indicate the location of SMA antenna module and provide a visual representation of the removal procedure.

NOTE: To upgrade to an SMA antenna, the internal antenna (white cable) must be removed.



1x
M3x3

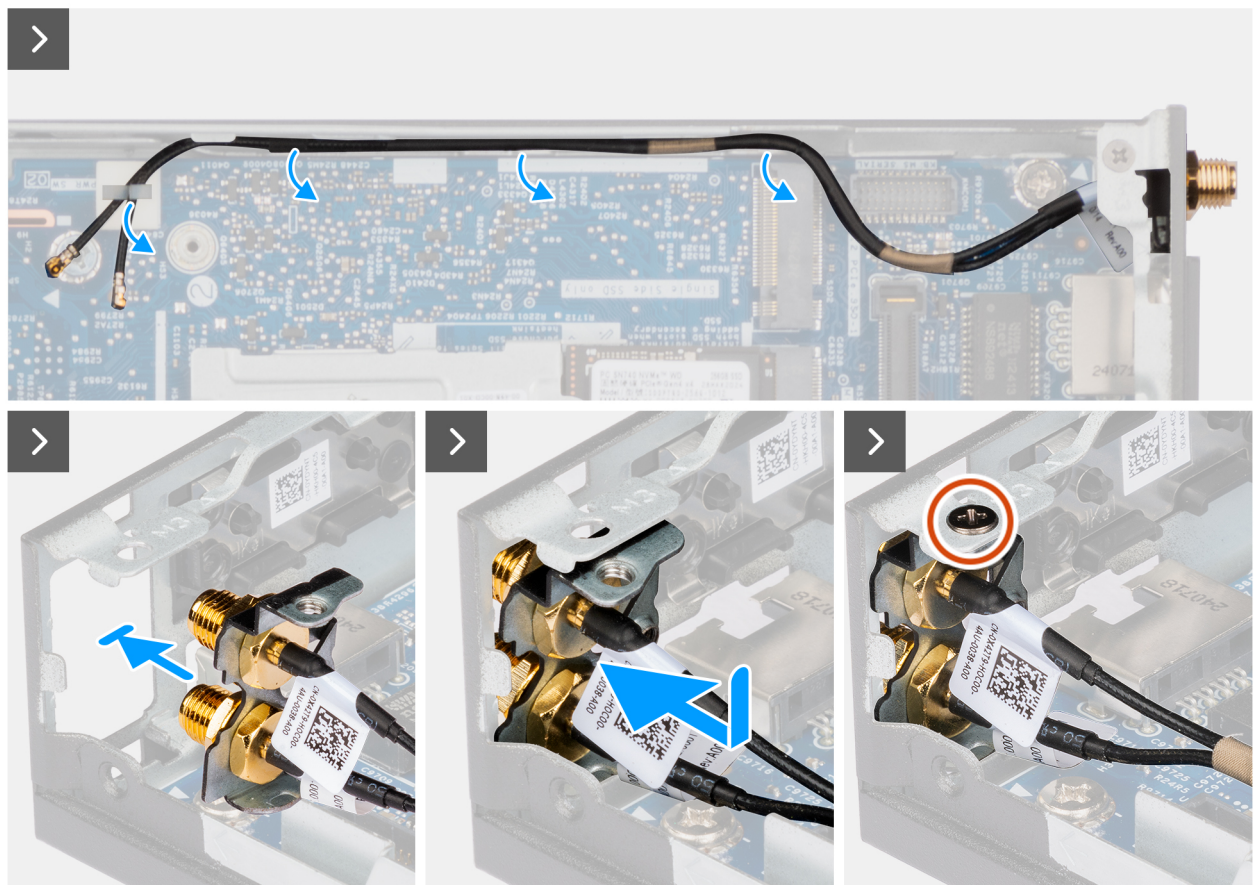
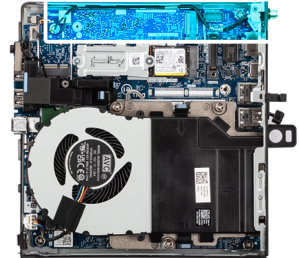

Figure 37. Installing SMA antenna module

1. Remove the fillers on the side cover, if applicable.
 2. Tilt the SMA antenna module and place it on the chassis.
 3. Insert the SMA antenna module through the opening at the back of the chassis.
 4. Replace the screw (M3x3) that secures the SMA module assembly to the chassis.
 5. Route the SMA antenna module cables through the routing guides on the chassis.
1. Install the [wireless card](#).
 2. Install the [side cover](#).
 3. Install the [external puck antenna](#), if applicable.
 4. Follow the procedure in [after working inside your computer](#).

Optional Input/Output modules

Dual USB 3.2 Gen 2 ports module

Removing the dual USB 3.2 Gen 2 module

1. Follow the procedure in [Before working inside your computer](#).
2. Remove the [side cover](#).

The following images indicate the location of the optional I/O module and provide a visual representation of the removal procedure.

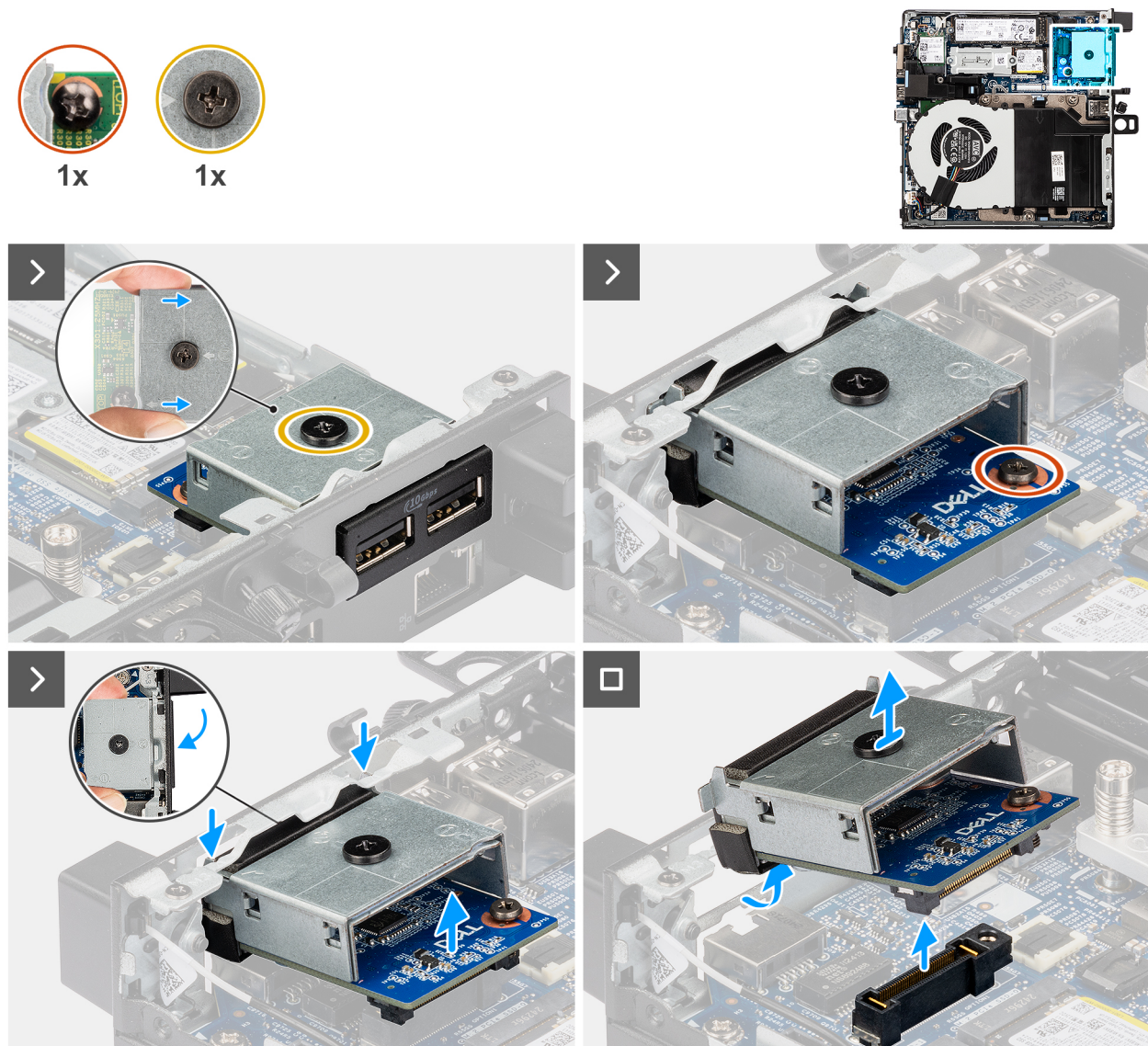

Figure 38. Removing the dual USB 3.2 Gen 2 module

1. Loosen the two captive screws that secure the dual USB 3.2 Gen 2 module to the chassis.
2. Disconnect the dual USB 3.2 Gen 2 module from the connector (OPTION) on the system board.
3. Lift the dual USB 3.2 Gen 2 module from its connector end at an angle, then move it downwards to detach it from the mounting points on the chassis.
4. Slide the dual USB 3.2 Gen 2 module and lift it away from the chassis.

Installing dual USB 3.2 Gen 2 module

If you are replacing a component, remove the existing component before performing the installation procedure.

The following images indicate the location of the dual USB 3.2 Gen 2 module and provide a visual representation of the installation procedure.

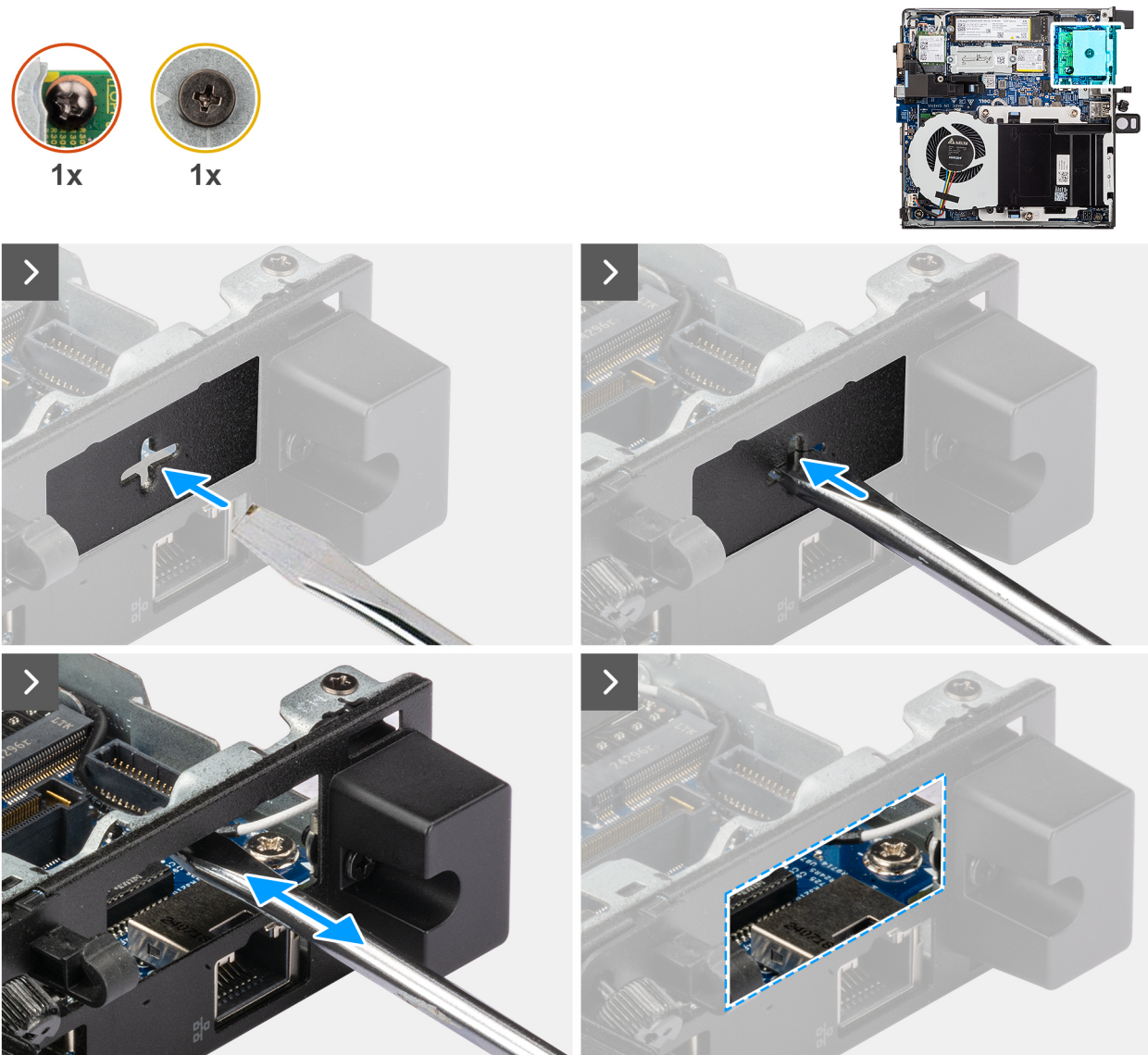

Figure 39. Installing dual USB 3.2 Gen 2 module

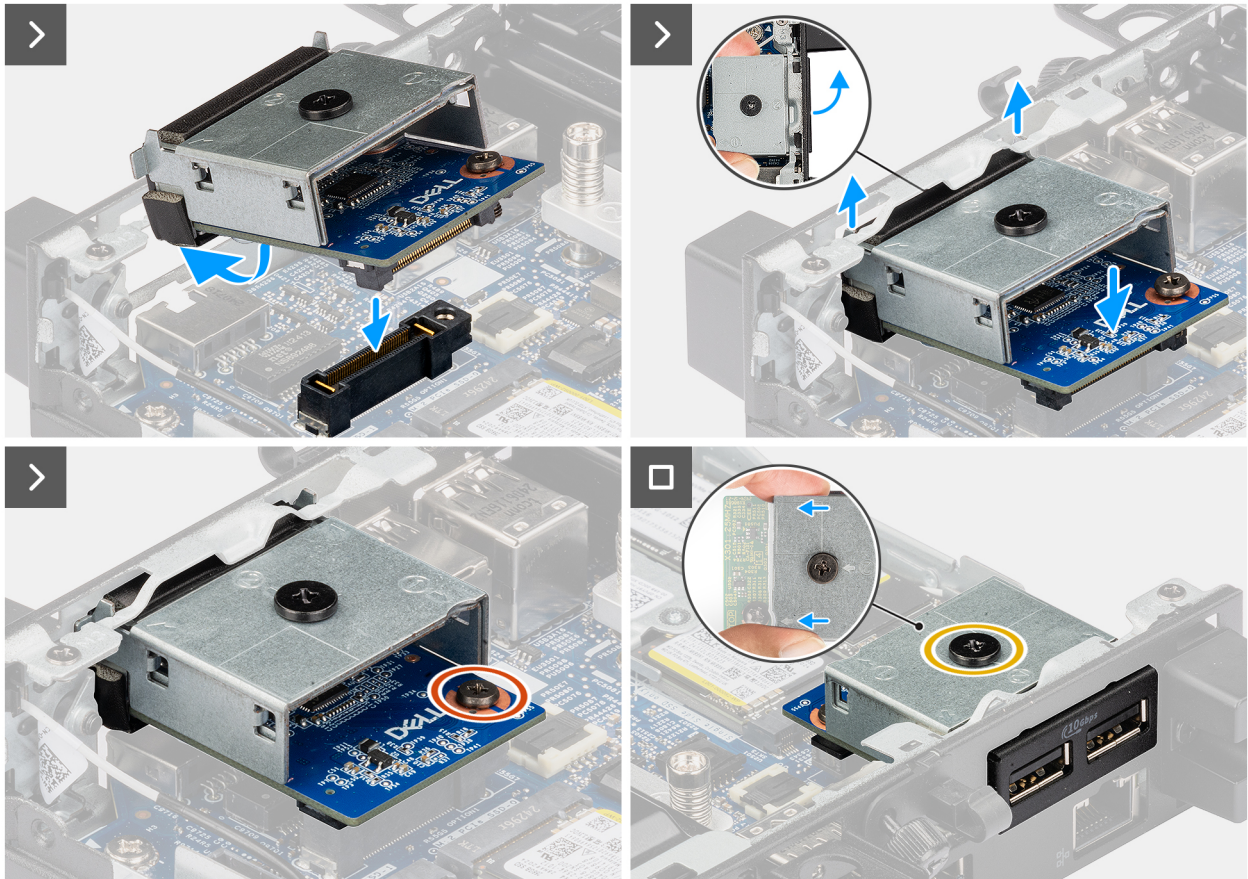

Figure 40. Installing the dual USB 3.2 Gen 2 module

1. **NOTE:** This step applies if you are upgrading a computer with no existing I/O module.

To remove the knock-out port cover, insert a flat-head screwdriver in the hole of the port cover from the outside of the computer. Push the knock-out port cover to release it, and then remove it out from the computer.

2. Insert the dual USB 3.2 Gen 2 module into its slot at the back panel of the computer.

NOTE: Ensure that the tabs on the dual USB 3.2 Gen 2 module align with the triangles that are engraved on the mounting point on the chassis.

3. Connect the dual USB 3.2 Gen 2 module to the connector (OPTION) on the system board.

4. Tighten the two captive screws to secure the dual USB 3.2 Gen 2 module to the chassis.

1. Install the [side cover](#).

2. Follow the procedure in [After working inside your computer](#).

USB Type-C port module with DisplayPort Alt mode and Power Delivery

Removing the USB Type-C module

1. Follow the procedure in [Before working inside your computer](#).
2. Remove the [side cover](#).

The following images indicate the location of the USB Type-C module and provide a visual representation of the removal procedure.



1x



1x

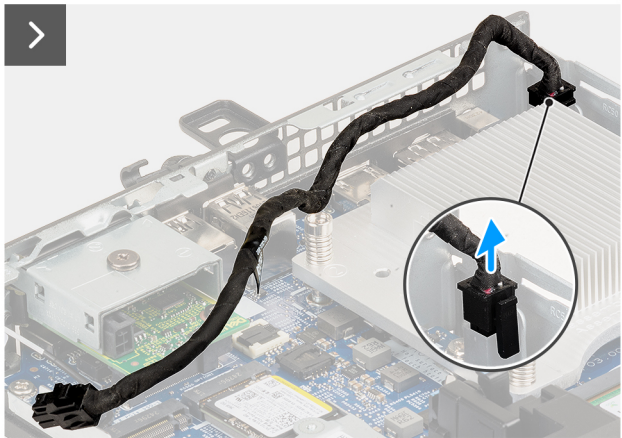
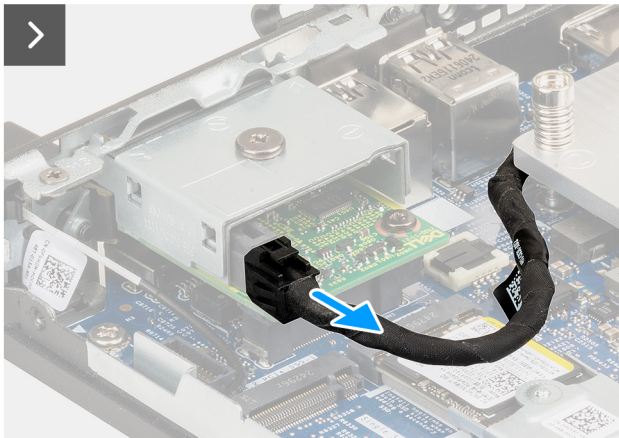
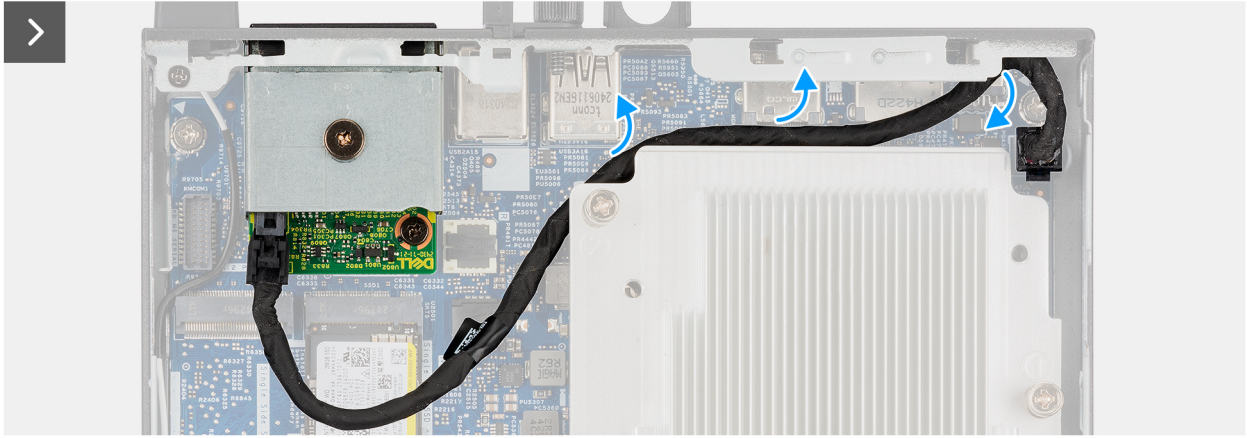
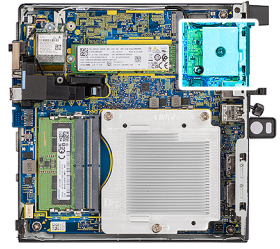

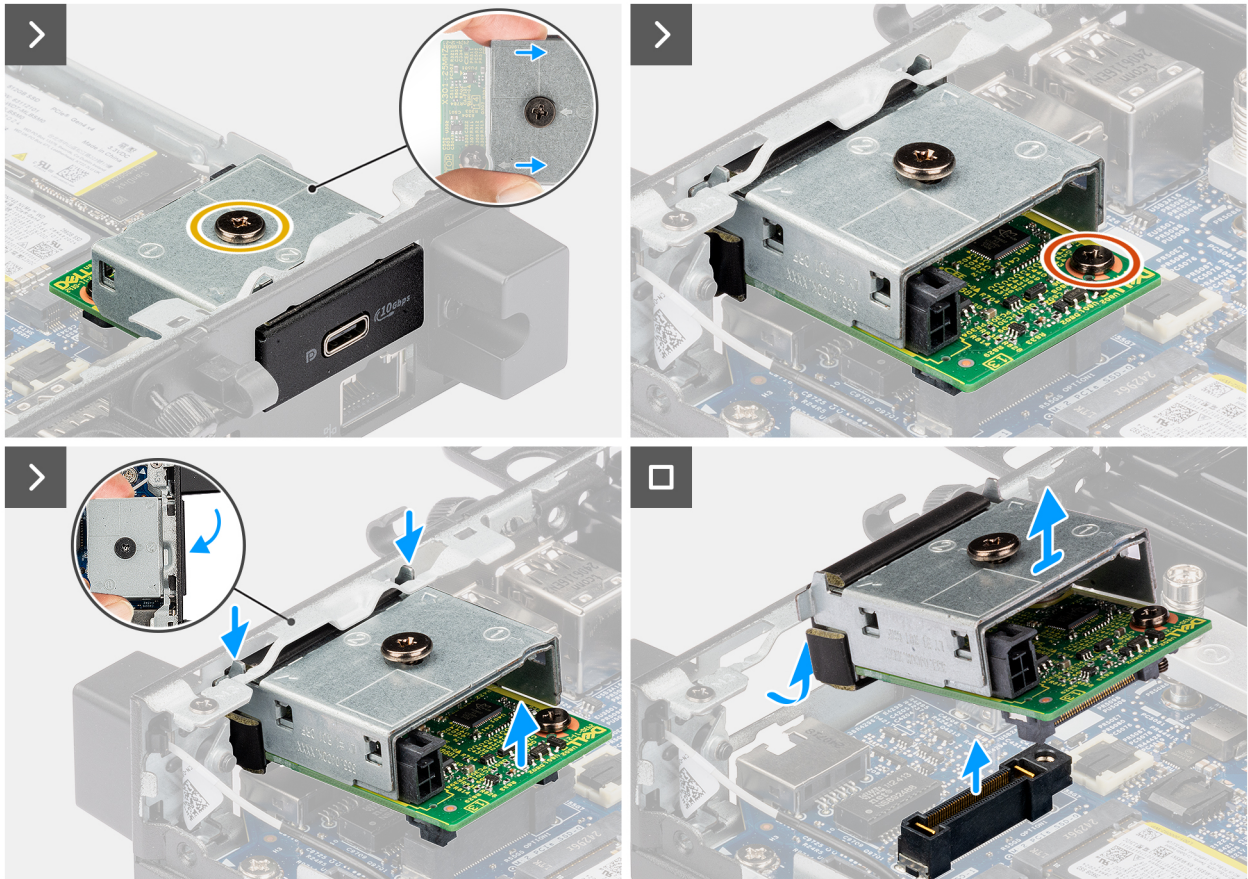

Figure 41. Removing the USB Type-C module

1. Remove the power-in cable from the routing points on the system board.
2. Disconnect the power-in cable from the connector on the USB Type-C port module.
3. Disconnect the power-in cable from the connector on the system board.
4. Loosen the two captive screws that secure the USB Type-C module to the chassis.
5. Disconnect the USB Type-C module from the connector (OPTION) on the system board.
6. Lift the USB Type-C module from its connector end to a certain angle and move the USB Type-C module downwards to detach it from the mounting points on the chassis.
7. Slide the USB Type-C module and lift it away from the chassis.

Installing the USB Type-C module

If you are replacing a component, remove the existing component before performing the installation procedure.

The following images indicate the location of the USB Type-C module and provide a visual representation of the installation procedure.

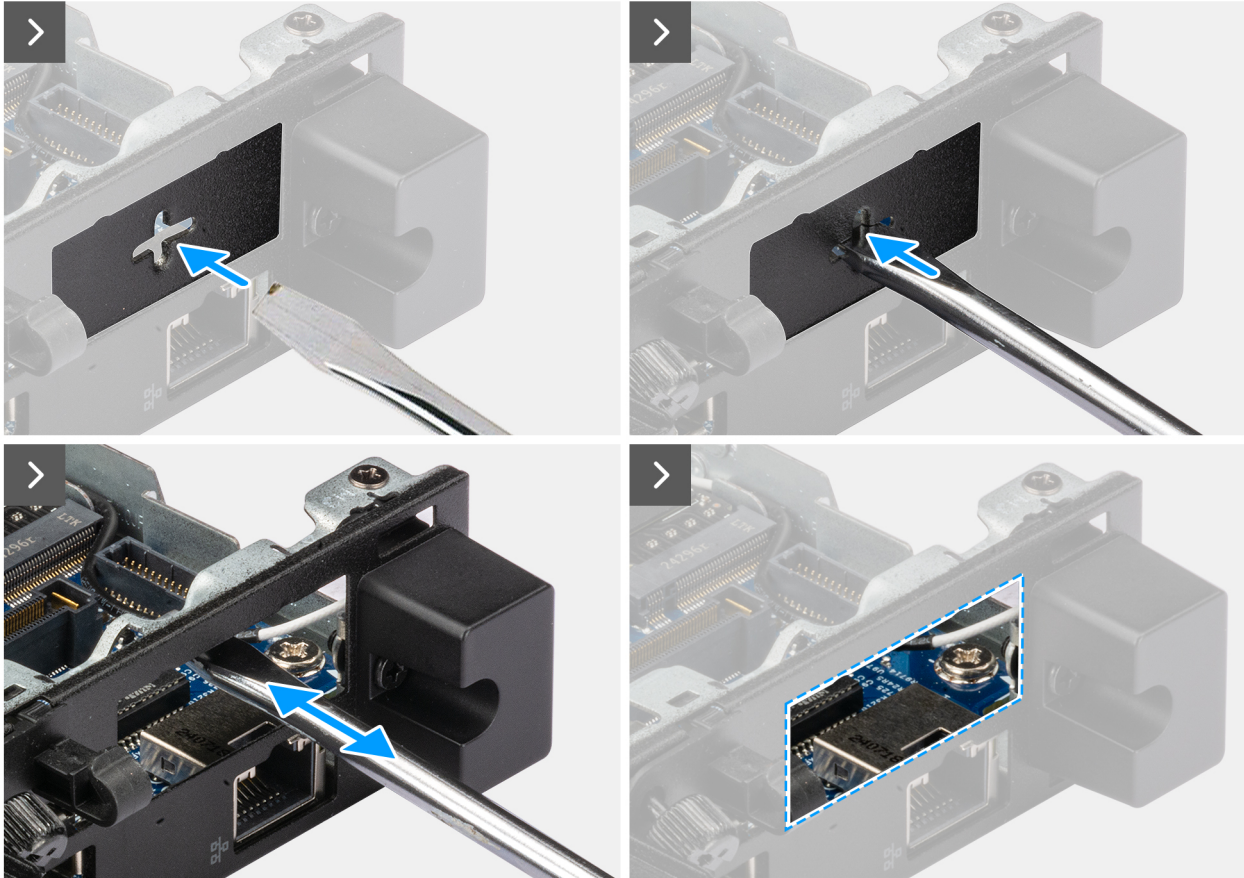
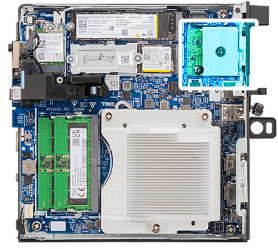
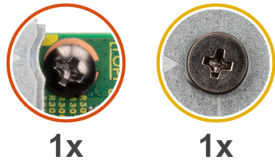

Figure 42. Installing the USB Type-C module

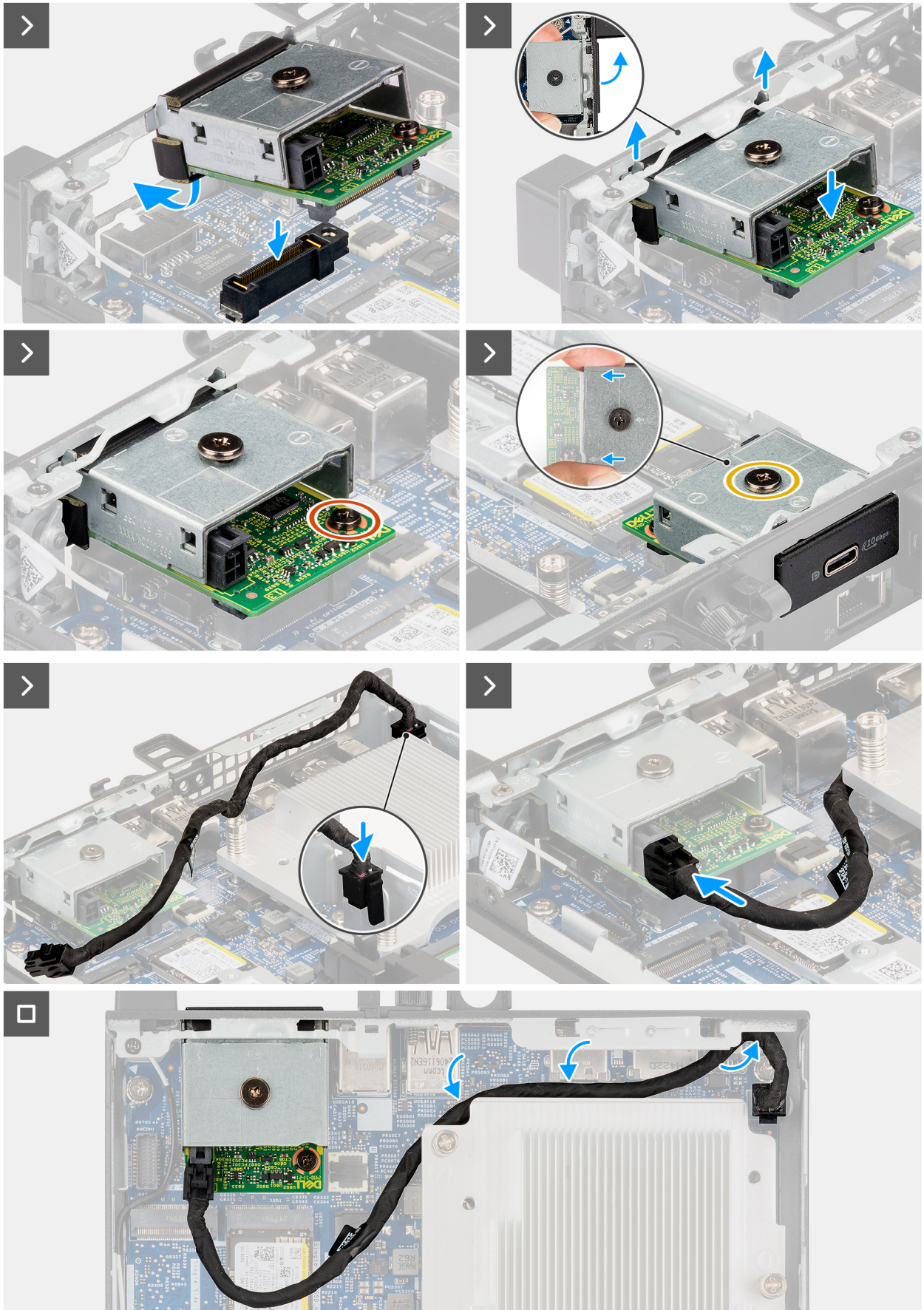

Figure 43. Installing the USB Type-C module

1. **NOTE:** This step applies if you are upgrading a computer with no existing I/O module.

To remove the knock-out port cover, insert a flat-head screwdriver in the hole of the port cover from the outside of the computer. Push the knock-out port cover to release it, and then remove it out from the computer.

2. Insert the USB Type-C module into its slot at the back panel of the computer.

NOTE: Ensure that the tabs on the USB Type-C module align with the triangles that are engraved on the mounting point on the chassis.

3. Connect the USB Type-C module to the connector (OPTION) on the system board.
 4. Tighten the two captive screws to secure the USB Type-C module to the chassis.
 5. Connect the power-in cable to the connector on the system board.
 6. Connect the power-in cable to the connector on the USB Type-C port module.
 7. Route the power-in cable through the designated routing points on the system board.
1. Install the [side cover](#).
 2. Follow the procedure in [After working inside your computer](#).

DisplayPort module

Removing the DisplayPort module

1. Follow the procedure in [Before working inside your computer](#).
2. Remove the [side cover](#).

The following images indicate the location of the DisplayPort module and provide a visual representation of the removal procedure.

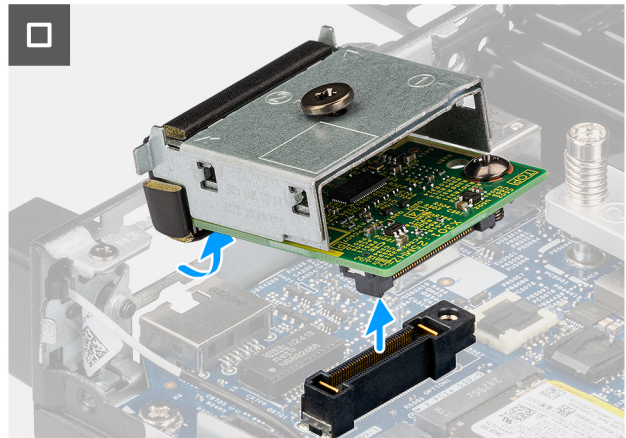
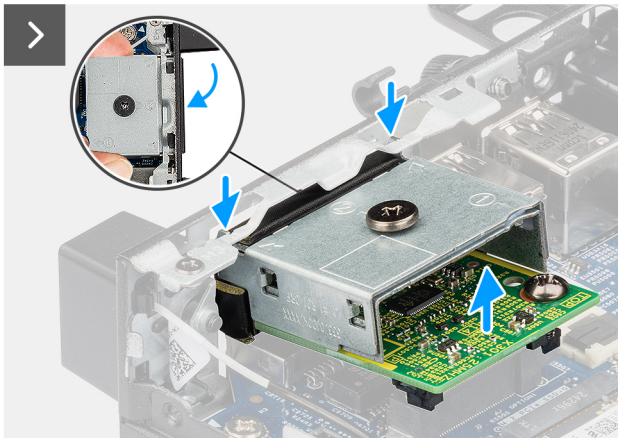
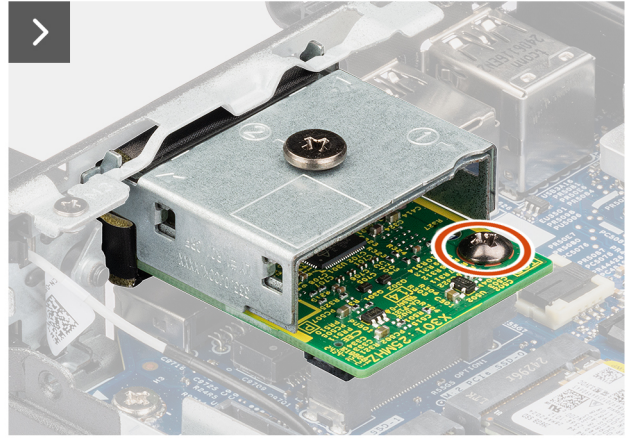
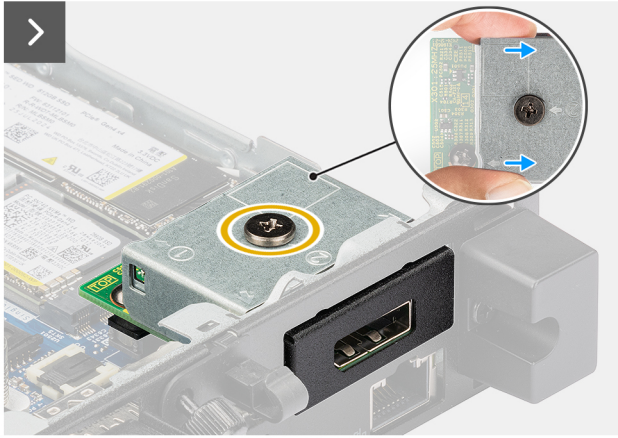
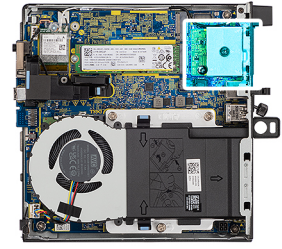
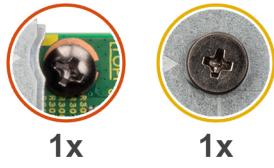

Figure 44. Removing the DisplayPort module

1. Loosen the two captive screws that secure the DisplayPort module to the chassis.
2. Disconnect the DisplayPort module from the connector (OPTION) on the system board.
3. Lift the DisplayPort module from its connector end to a certain angle and move the DisplayPort module downwards to detach it from the mounting points on the chassis.
4. Slide the DisplayPort module and lift it away from the chassis.

Installing the DisplayPort module

If you are replacing a component, remove the existing component before performing the installation procedure.

The following images indicate the location of the DisplayPort module and provide a visual representation of the installation procedure.

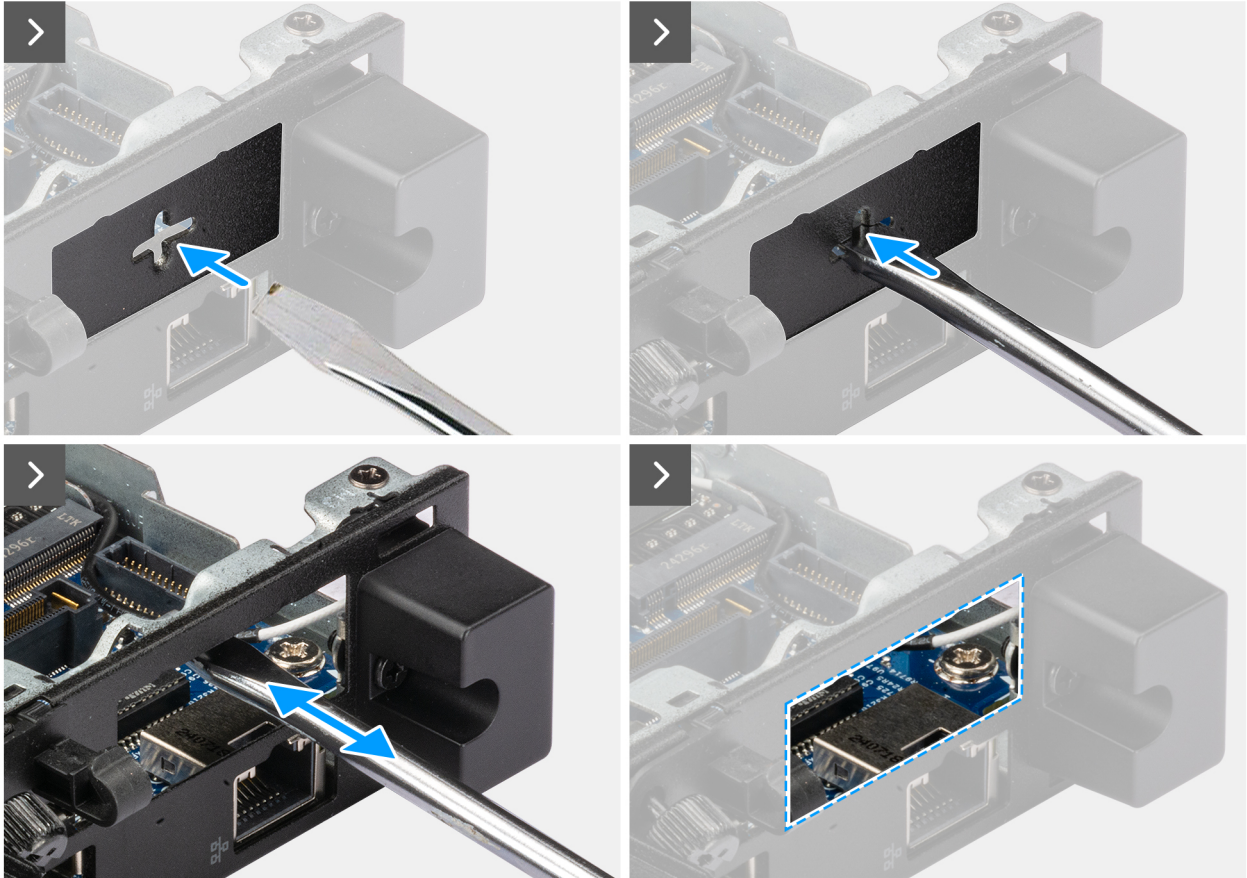
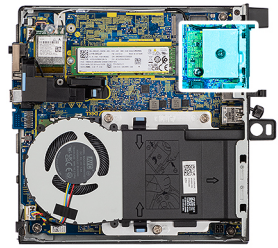
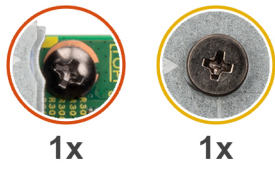

Figure 45. Installing DisplayPort module

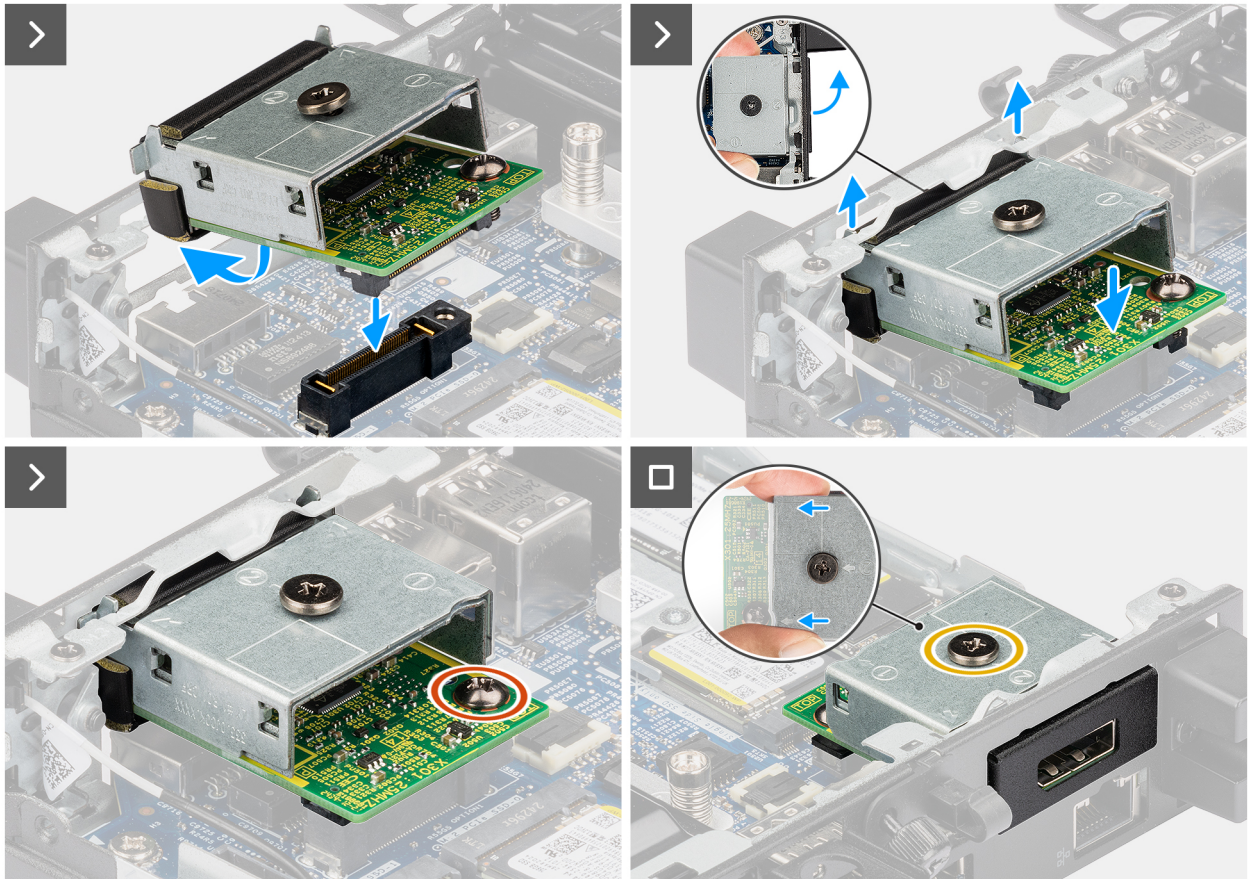

Figure 46. Installing DisplayPort module

1. **NOTE:** This step applies if you are upgrading a computer with no existing I/O module.

To remove the knock-out port cover, insert a flat-head screwdriver in the hole of the port cover from the outside of the computer. Push the knock-out port cover to release it, and then remove it out from the computer.

2. Insert the DisplayPort module into its slot at the back panel of the computer.

NOTE: Ensure that the tabs on the DisplayPort module align with the triangles that are engraved on the mounting point on the chassis.

3. Connect the DisplayPort module to the connector (OPTION) on the system board.
4. Tighten the two captive screws to secure the DisplayPort module to the chassis.

1. Install the [side cover](#).
2. Follow the procedure in [After working inside your computer](#).

HDMI port module

Removing the HDMI module

1. Follow the procedure in [Before working inside your computer](#).
2. Remove the [side cover](#).

The following images indicate the location of the HDMI module and provide a visual representation of the removal procedure.

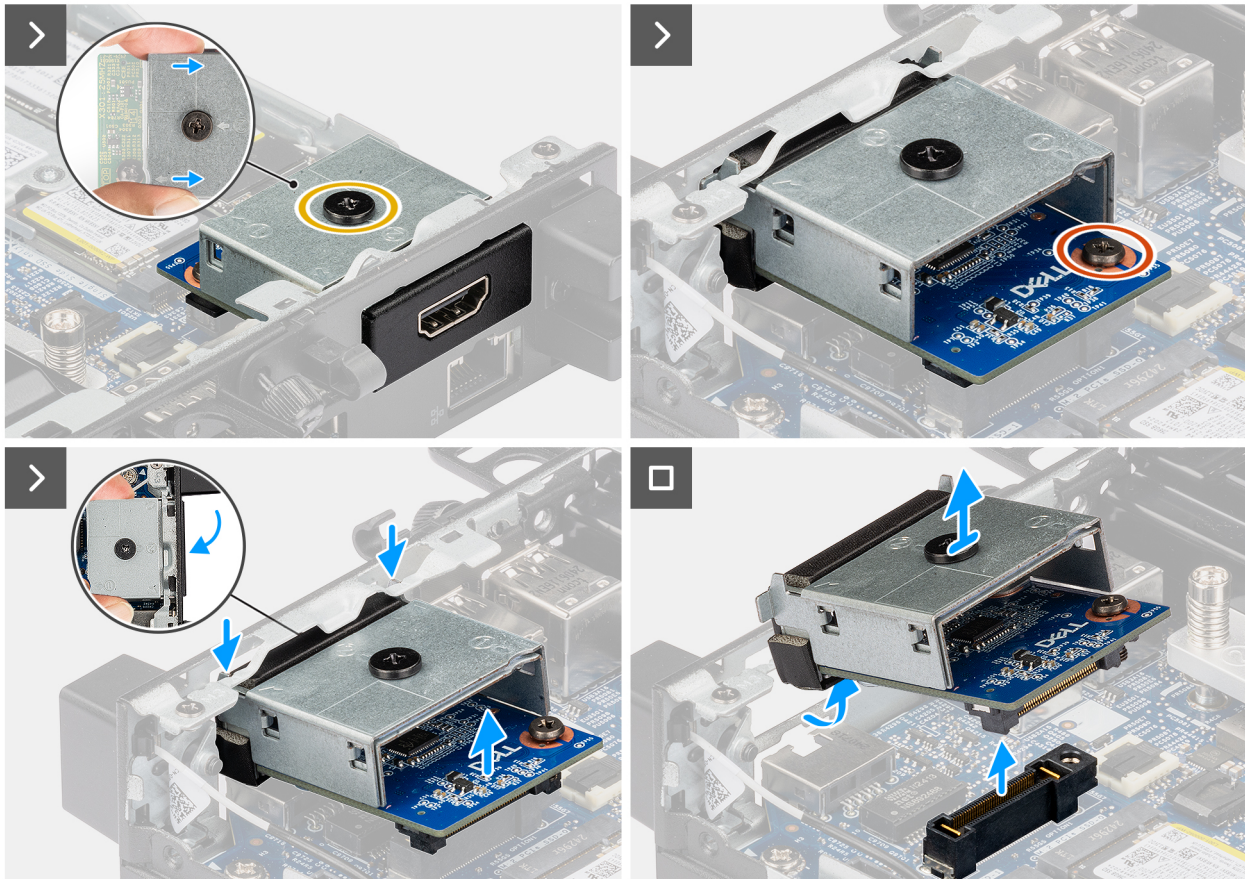
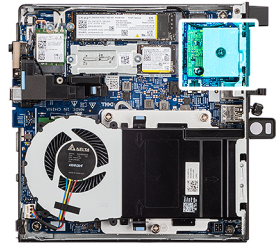
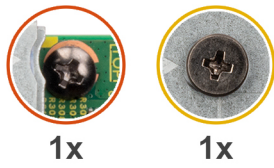

Figure 47. Removing the HDMI module

1. **NOTE:** This step applies if you are upgrading a computer with no existing I/O module.

To remove the knock-out port cover, insert a flat-head screwdriver in the hole of the port cover from the outside of the computer. Push the knock-out port cover to release it, and then remove it out from the computer.

2. Insert the HDMI module into its slot at the back panel of the computer.

NOTE: Ensure that the tabs on the HDMI module align with the triangles that are engraved on the mounting point on the chassis.

3. Connect the HDMI module to the connector (OPTION) on the system board.
4. Tighten the two captive screws to secure the HDMI module to the chassis.

Installing the HDMI module

If you are replacing a component, remove the existing component before performing the installation procedure.

The following images indicate the location of the HDMI module and provide a visual representation of the installation procedure.

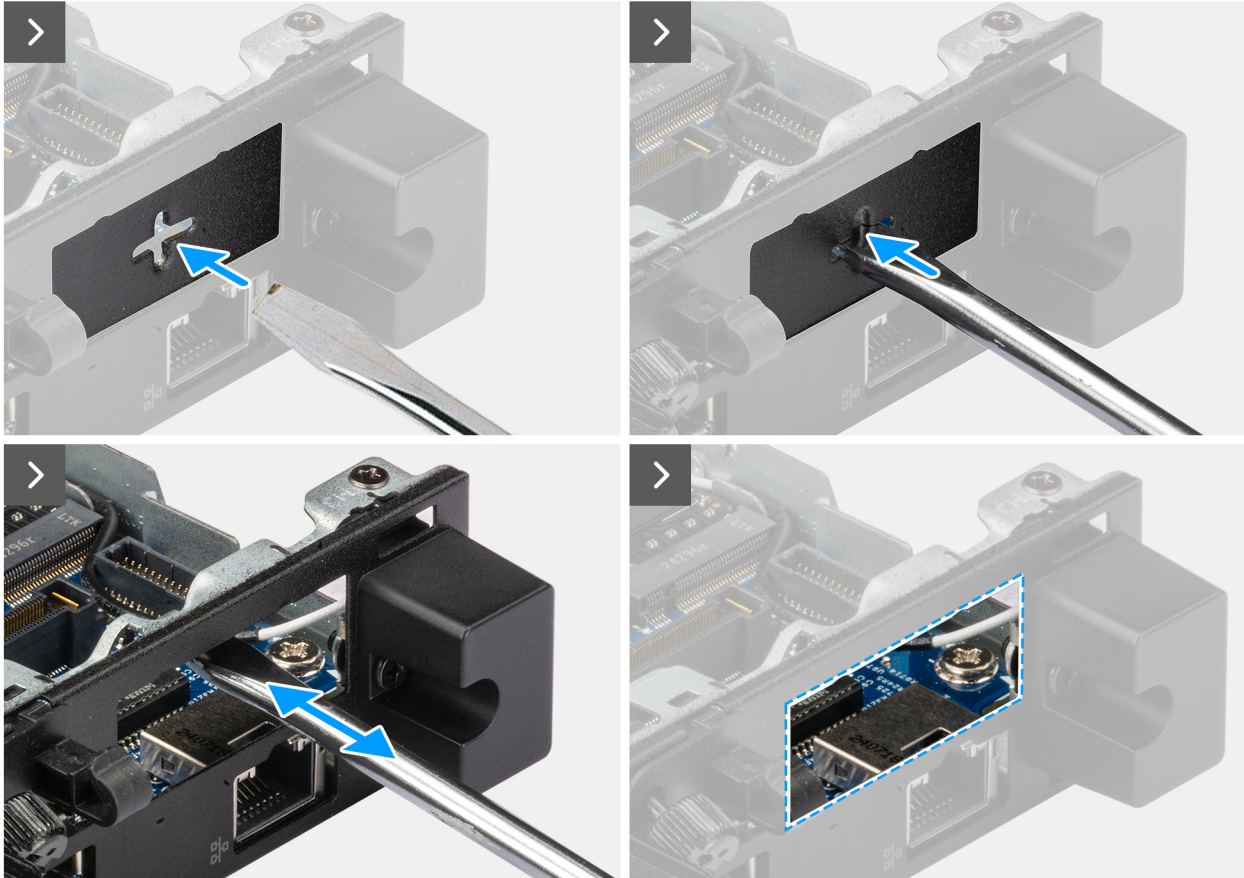
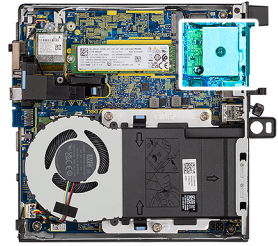
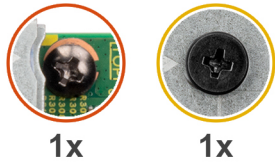

Figure 48. Installing HDMI module

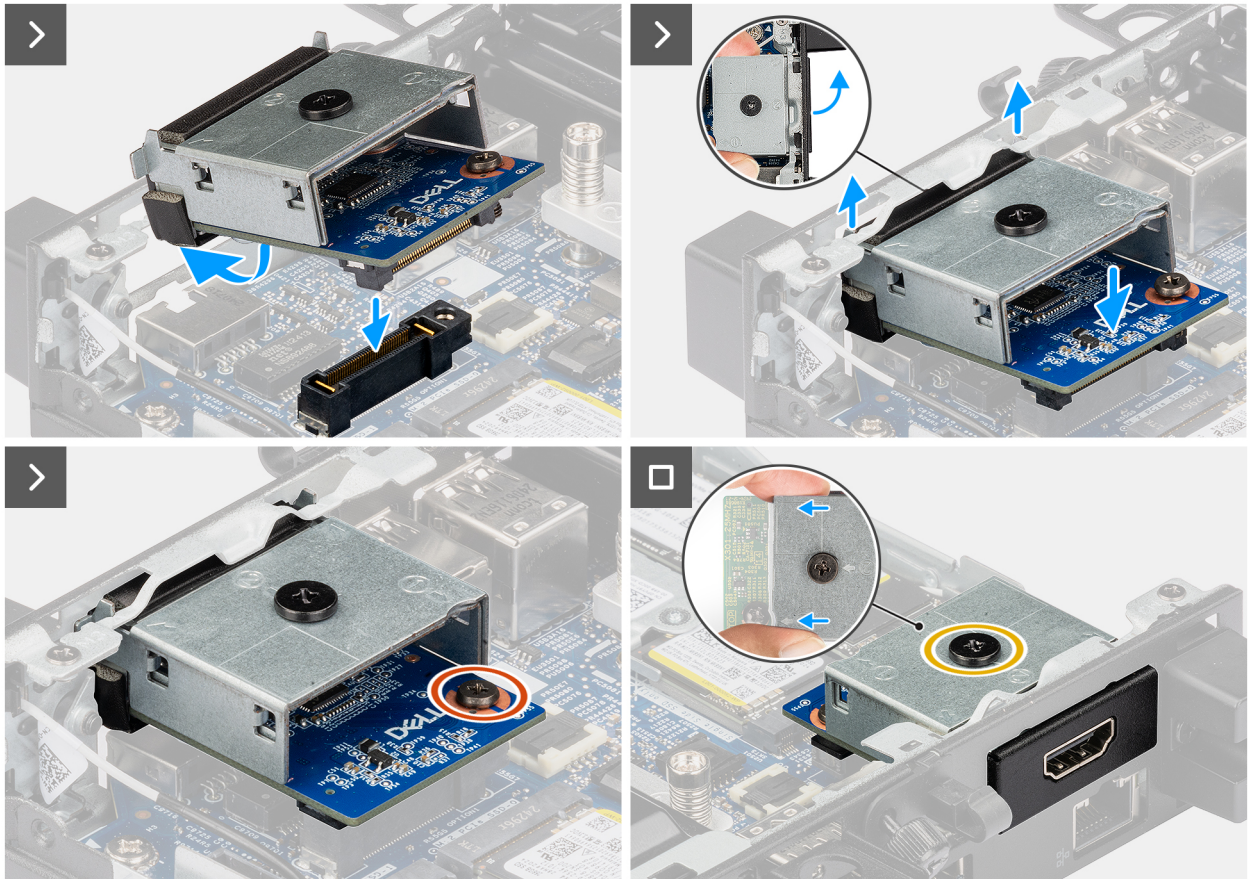

Figure 49. Installing HDMI module

1. **NOTE:** This step applies if you are upgrading a computer with no existing I/O module.

To remove the knock-out port cover, insert a flat-head screwdriver in the hole of the port cover from the outside of the computer. Push the knock-out port cover to release it, and then remove it out from the computer.

2. Insert the HDMI module into its slot at the back panel of the computer.

NOTE: Ensure that the tabs on the HDMI module align with the triangles that are engraved on the mounting point on the chassis.

3. Connect the HDMI module to the connector (OPTION) on the system board.
4. Tighten the two captive screws to secure the HDMI module to the chassis.

1. Install the [side cover](#).
2. Follow the procedure in [After working inside your computer](#).

VGA port module

Removing the VGA module

1. Follow the procedure in [Before working inside your computer](#).
2. Remove the [side cover](#).

The following images indicate the location of the VGA module and provide a visual representation of the removal procedure.

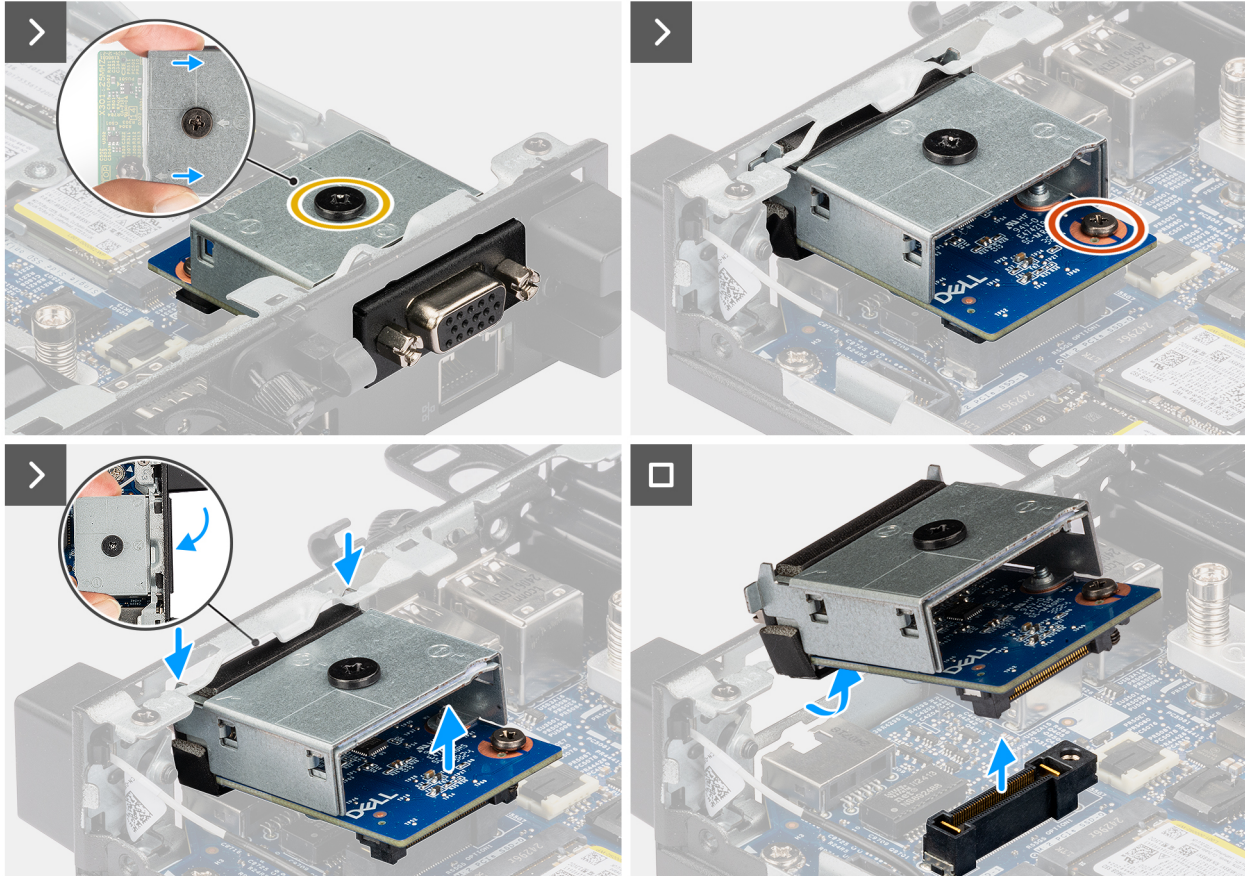
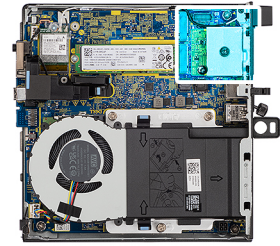
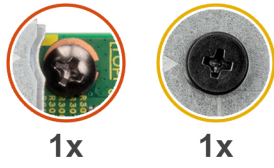

Figure 50. Removing the VGA module

1. Loosen the two captive screws that secure the VGA module to the chassis.
2. Disconnect the VGA module from the connector (OPTION) on the system board.
3. Lift the VGA module from its connector end to a certain angle and move the VGA module downwards to detach it from the mounting points on the chassis.
4. Slide the VGA module and lift it away from the chassis.

Installing the VGA module

If you are replacing a component, remove the existing component before performing the installation procedure.

The following images indicate the location of the optional I/O module and provide a visual representation of the installation procedure.

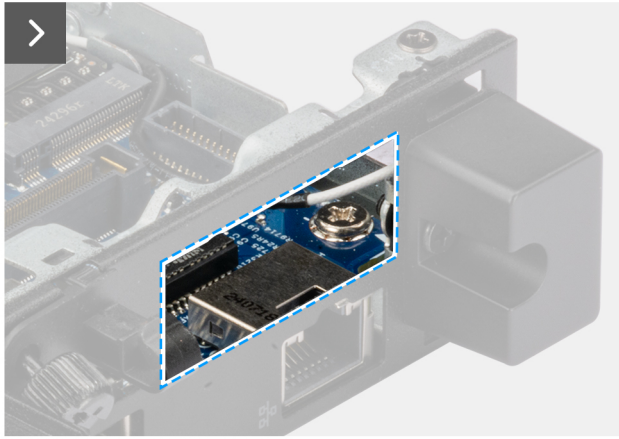
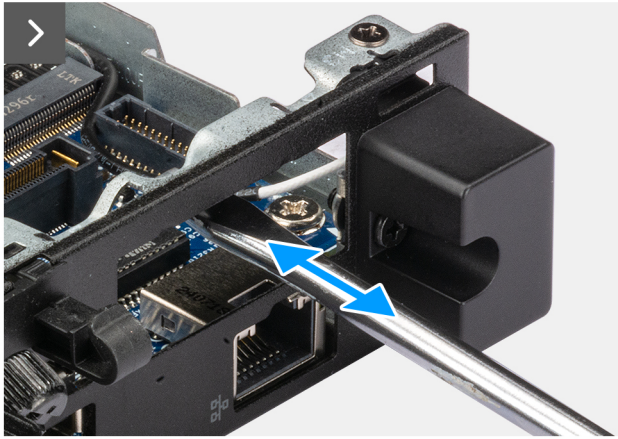
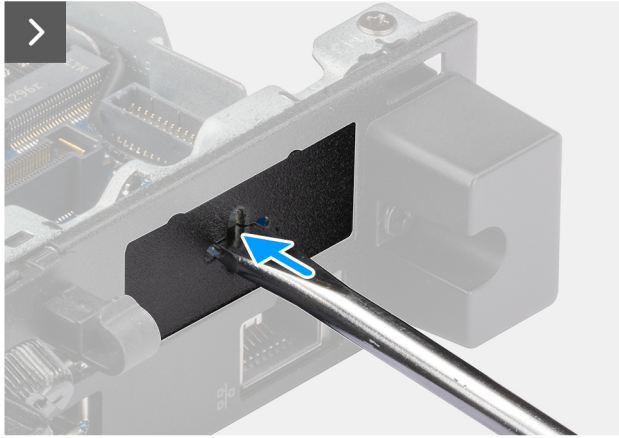
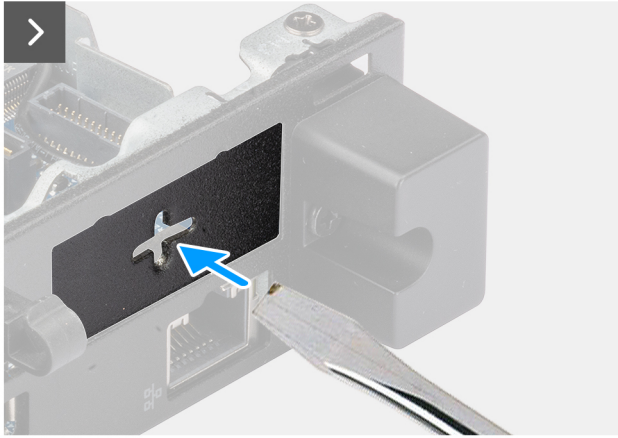
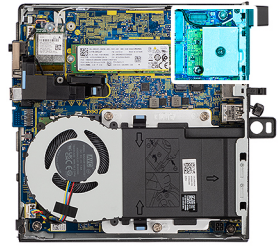
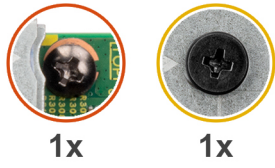

Figure 51. Installing VGA module

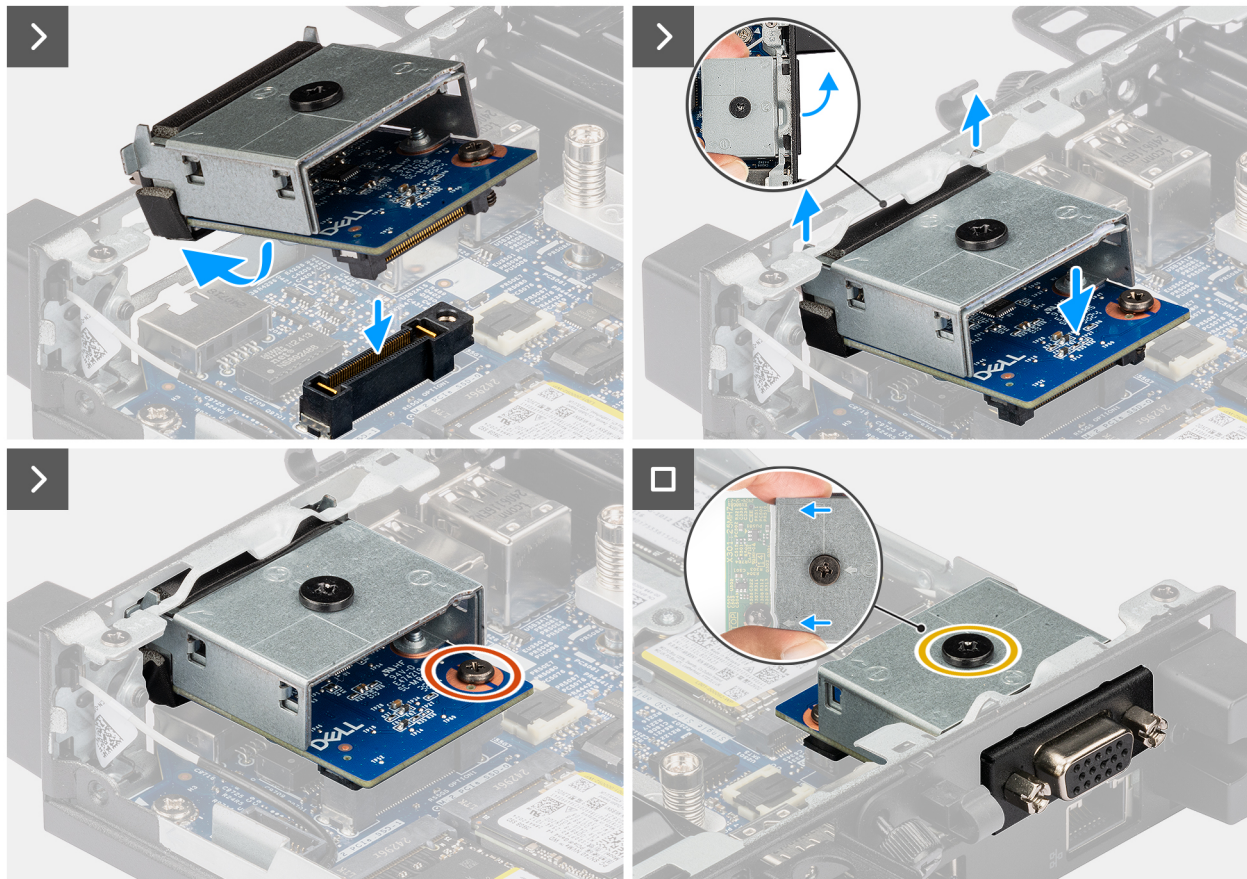

Figure 52. Installing VGA module

1. **NOTE:** This step applies if you are upgrading a computer with no existing I/O module.

To remove the knock-out port cover, insert a flat-head screwdriver in the hole of the port cover from the outside of the computer. Push the knock-out port cover to release it, and then remove it out from the computer.

2. Insert the VGA module into its slot at the back panel of the computer.

NOTE: Ensure that the tabs on the VGA module align with the triangles that are engraved on the mounting point on the chassis.

3. Connect the VGA module to the connector (OPTION) on the system board.
4. Tighten the two captive screws to secure the VGA module to the chassis.

1. Install the [side cover](#).
2. Follow the procedure in [After working inside your computer](#).

PS2 port module

Removing the PS2 module

1. Follow the procedure in [Before working inside your computer](#).
2. Remove the [side cover](#).

The following images indicate the location of the PS2 module and provide a visual representation of the removal procedure.

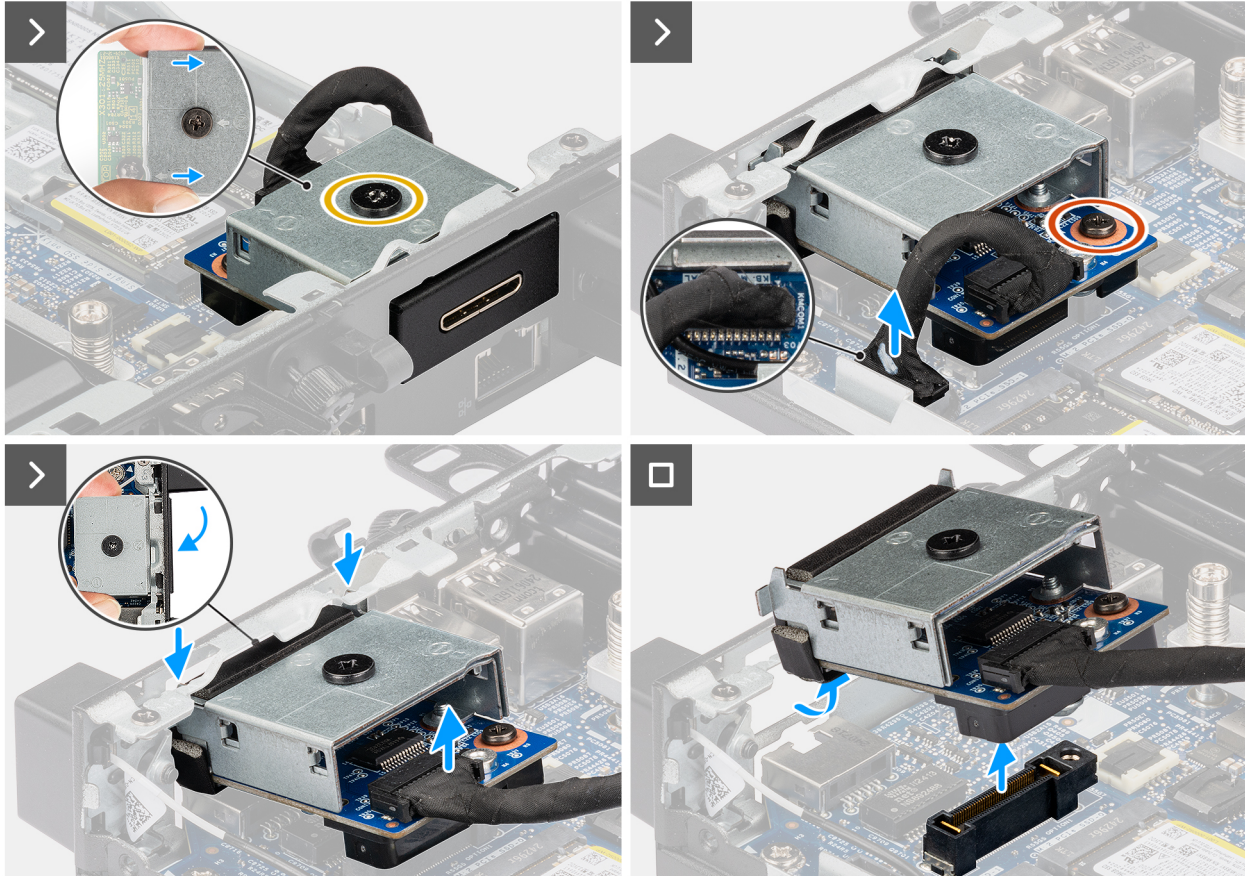
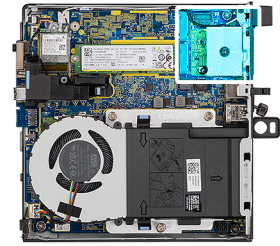
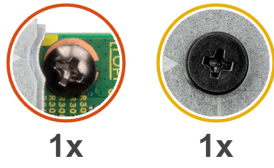

Figure 53. Removing the PS2 module

1. Loosen the two captive screws that secure the PS2 module to the chassis.
2. Disconnect the PS2 module cable from the connector (KB MS SERIAL) on the system board.
3. Lift the PS2 module from its connector end to a certain angle and move the PS2 module downwards to detach it from the mounting points on the chassis.
4. Slide the PS2 module and lift it away from the chassis.

Installing the PS2 module

If you are replacing a component, remove the existing component before performing the installation procedure.

The following images indicate the location of the PS2 module and provide a visual representation of the installation procedure.

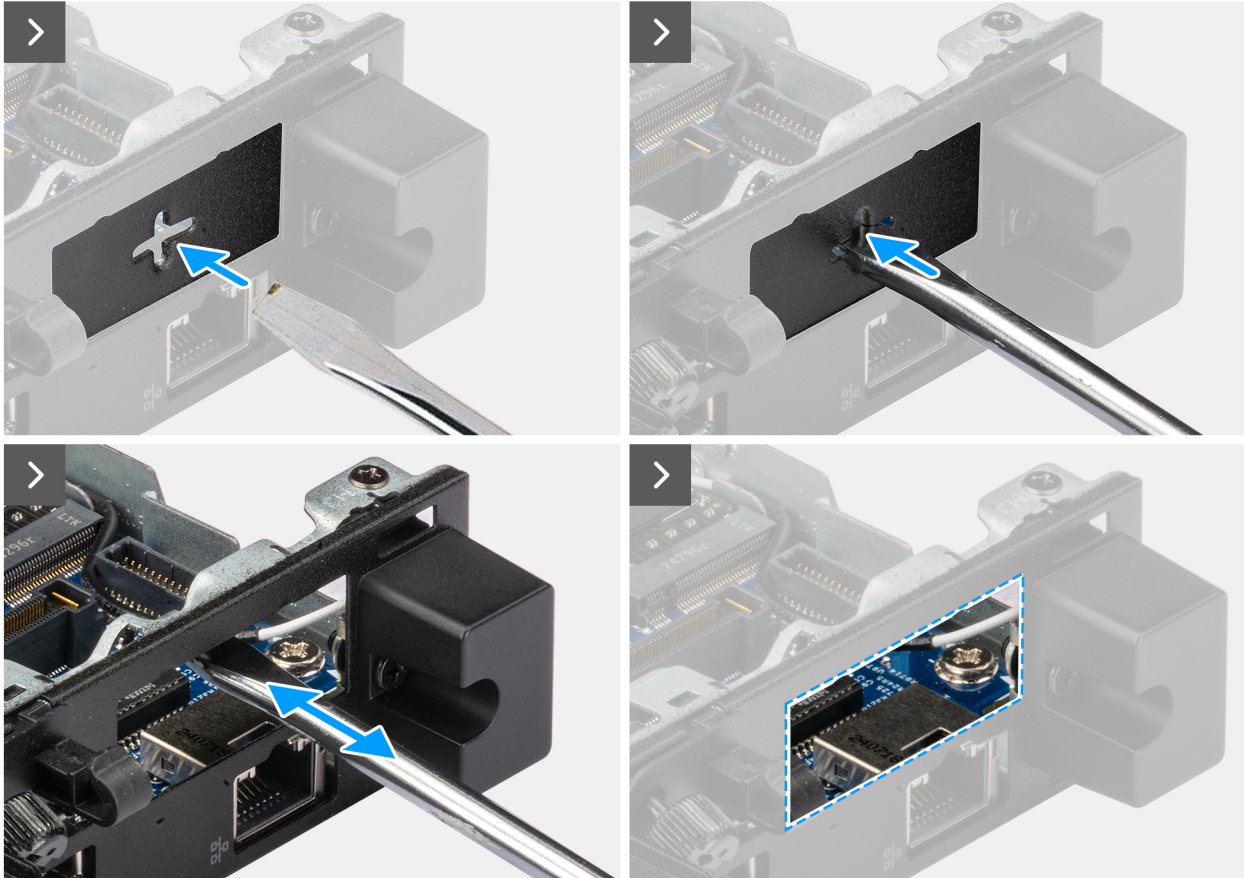
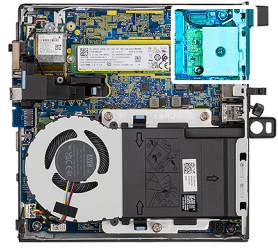
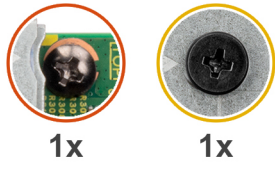

Figure 54. Installing the PS2 module

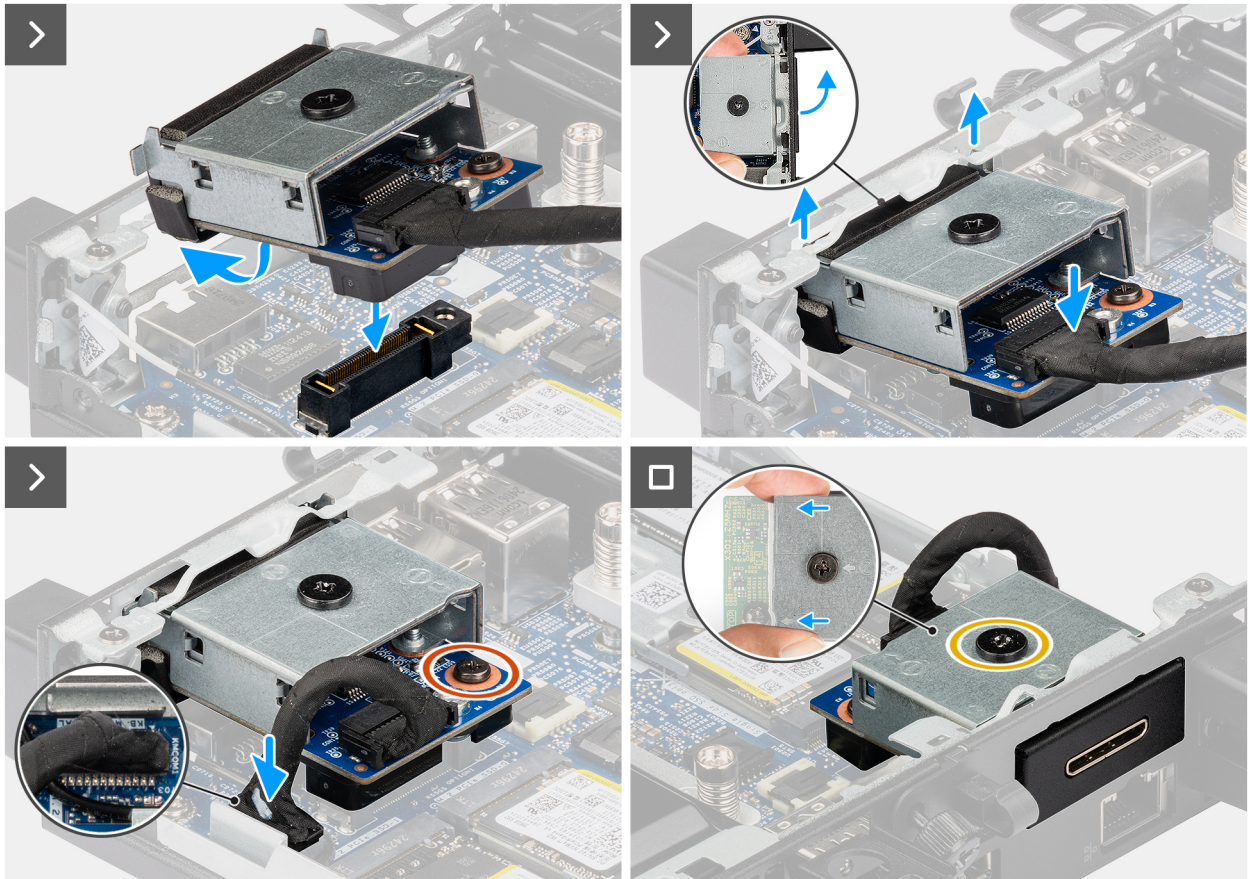

Figure 55. Installing the PS2 module

1. **NOTE:** This step applies if you are upgrading a computer with no existing I/O module.

To remove the knock-out port cover, insert a flat-head screwdriver in the hole of the port cover from the outside of the computer. Push the knock-out port cover to release it, and then remove it out from the computer.

2. Insert the PS2 module into its slot at the back panel of the computer.

NOTE: Ensure that the tabs on the PS2 module align with the triangles that are engraved on the mounting point on the chassis.

3. Connect the PS2 module cable to the connector (KB MS SERIAL) on the system board.
4. Tighten the two captive screws to secure the PS2 module to the chassis.

1. Follow the procedure in [After working inside your computer](#).

Serial port module

Removing the Serial module

1. Follow the procedure in [Before working inside your computer](#).
2. Remove the [side cover](#).

The following images indicate the location of the Serial module and provide a visual representation of the removal procedure.

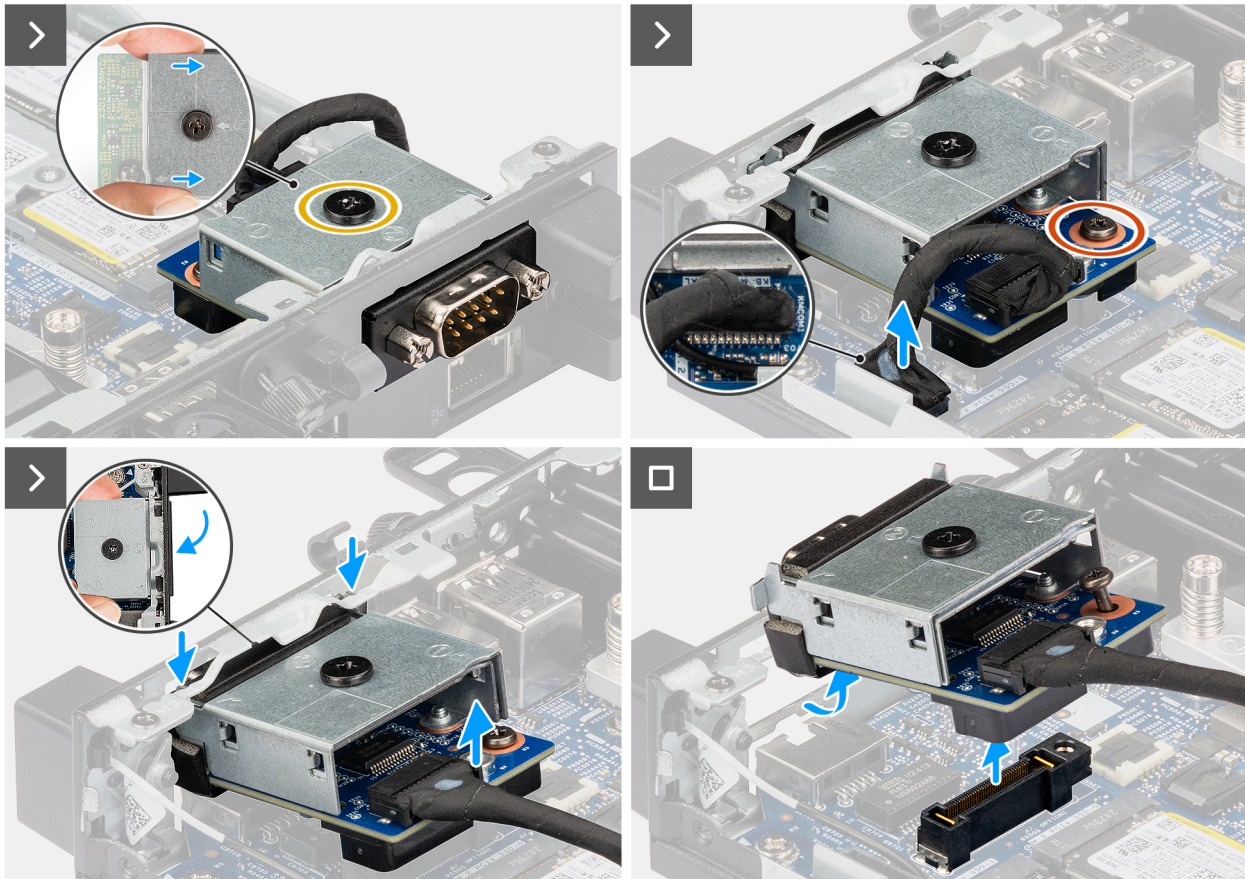
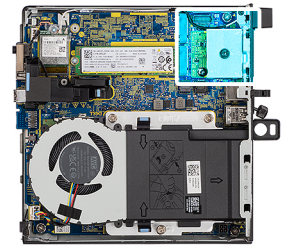
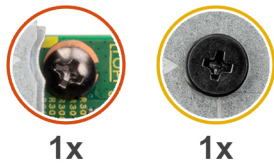

Figure 56. Removing the Serial module

1. Loosen the two captive screws that secure the Serial module to the chassis.
2. Disconnect the Serial module cable from the connector (KB MS SERIAL) on the system board.
3. Lift the Serial module from its connector end to a certain angle and move the Serial module downwards to detach it from the mounting points on the chassis.
4. Slide the Serial module and lift it away from the chassis.

Installing the Serial module

If you are replacing a component, remove the existing component before performing the installation procedure.

The following images indicate the location of the Serial module and provide a visual representation of the installation procedure.

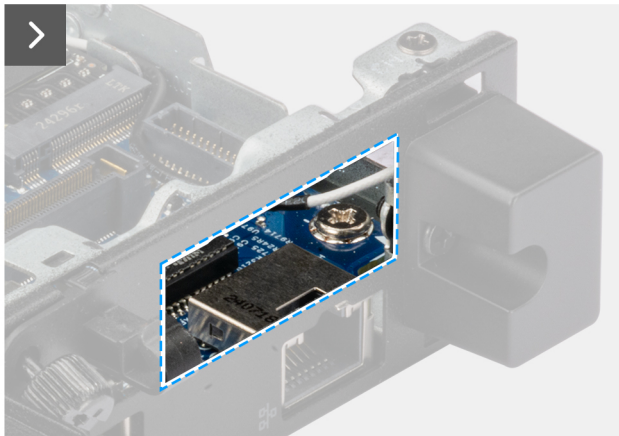
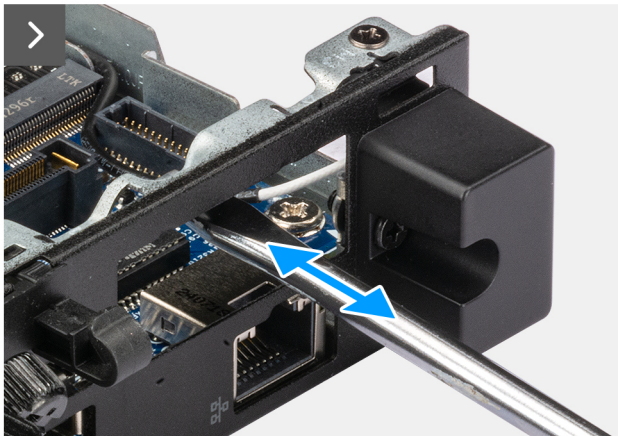
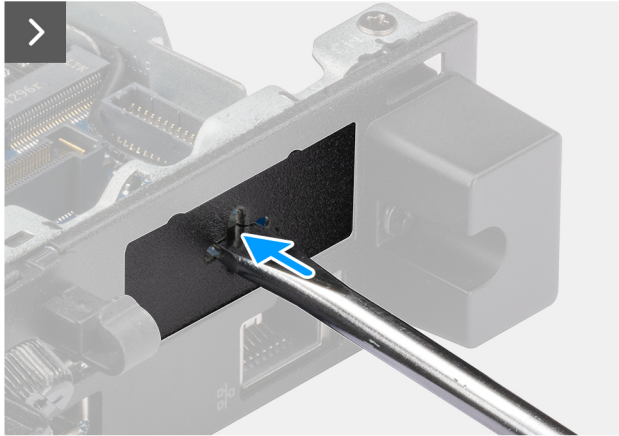
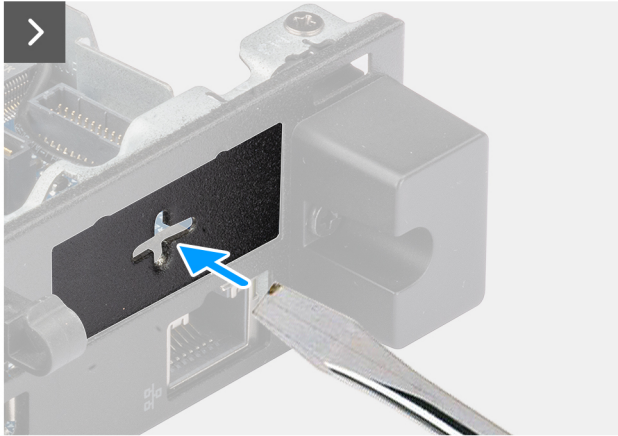
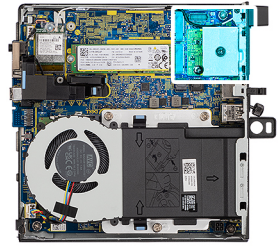
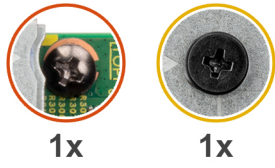

Figure 57. Installing Serial module

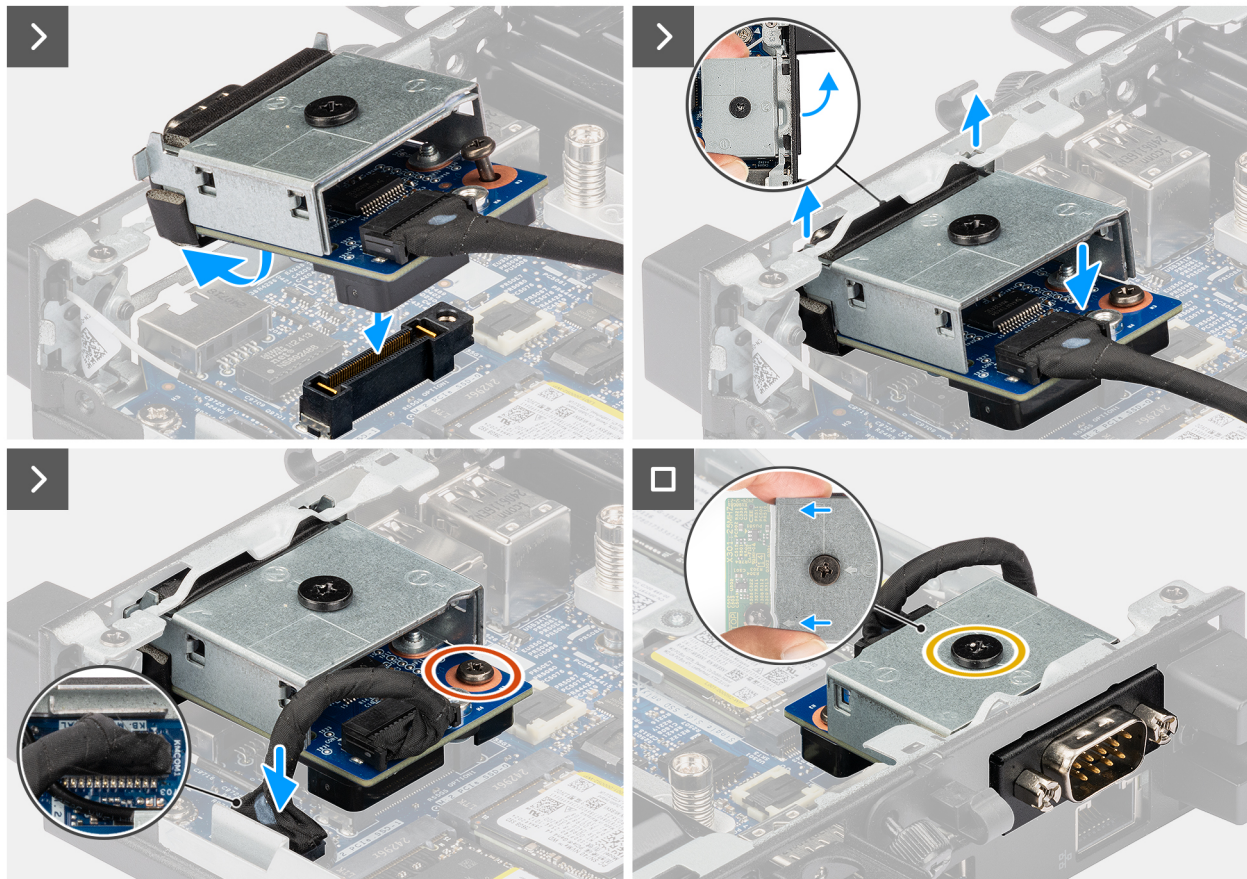

Figure 58. Installing Serial module

1. **NOTE:** This step applies if you are upgrading a computer with no existing I/O module.

To remove the knock-out port cover, insert a flat-head screwdriver in the hole of the port cover from the outside of the computer. Push the knock-out port cover to release it, and then remove it out from the computer.

2. Insert the Serial module into its slot at the back panel of the computer.

NOTE: Ensure that the tabs on the Serial module align with the triangles that are engraved on the mounting point on the chassis.

3. Connect the Serial module cable to the connector (KB MS SERIAL) on the system board.
4. Tighten the two captive screws to secure the Serial module to the chassis.

1. Install the [side cover](#).
2. Follow the procedure in [After working inside your computer](#).

Fiber optic port module

Removing the fiber optic port module

1. Follow the procedure in [Before working inside your computer](#).
2. Remove the [side cover](#).

The following images indicate the location of the fiber optic port module and provide a visual representation of the removal procedure.

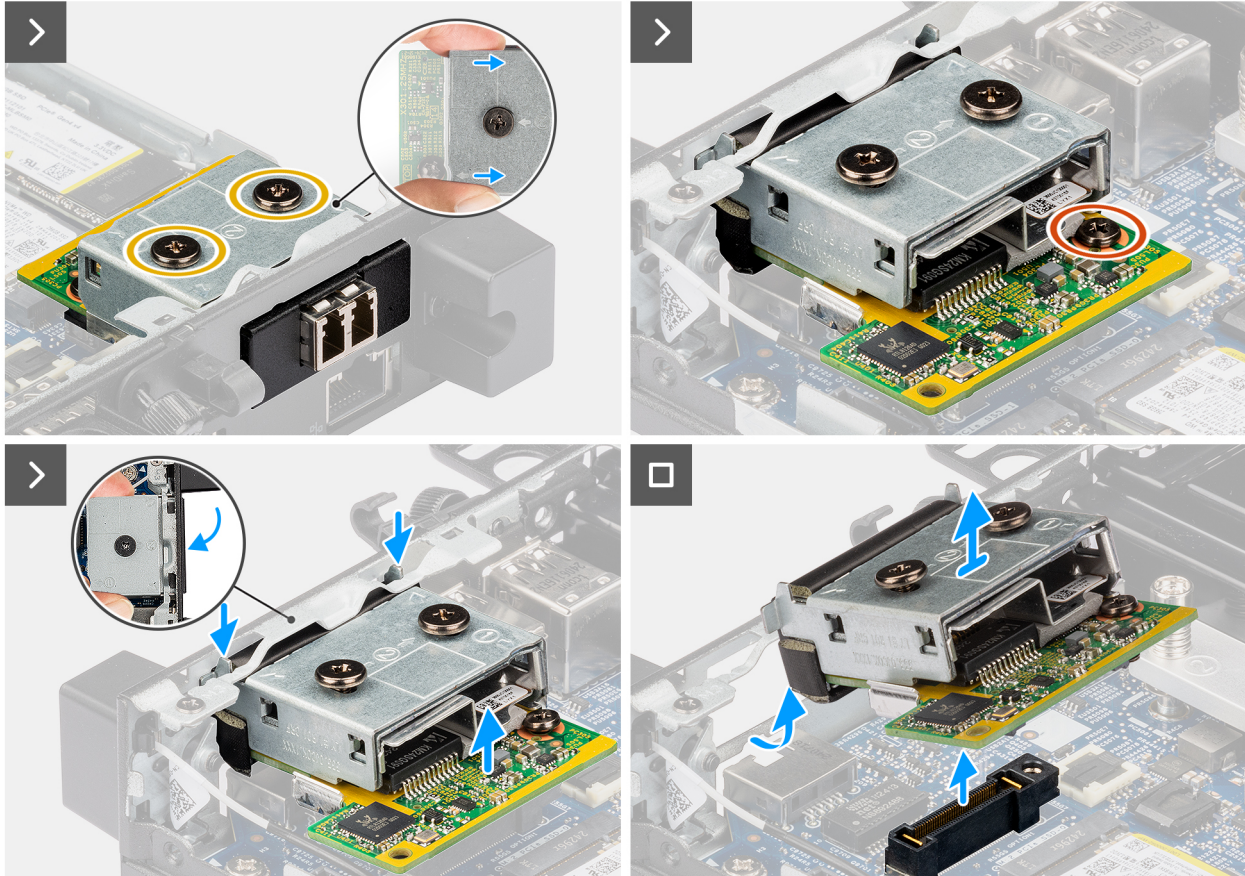
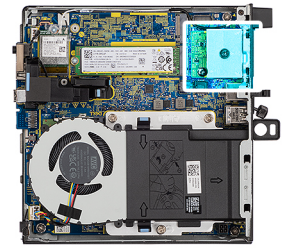
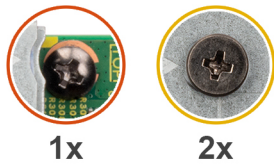

Figure 59. Removing the fiber optic port module

1. Loosen the three captive screws that secure the fiber optic port module to the chassis.
2. Disconnect the fiber optic port module from the connector (OPTION) on the system board.
3. Lift the fiber optic port module from its connector end to a certain angle and move the fiber optic port module downwards to detach it from the mounting points on the chassis.
4. Slide the fiber optic port module and lift it away from the chassis.

Installing the fiber optic port module

If you are replacing a component, remove the existing component before performing the installation procedure.

The following images indicate the location of the fiber optic port module and provide a visual representation of the installation procedure.

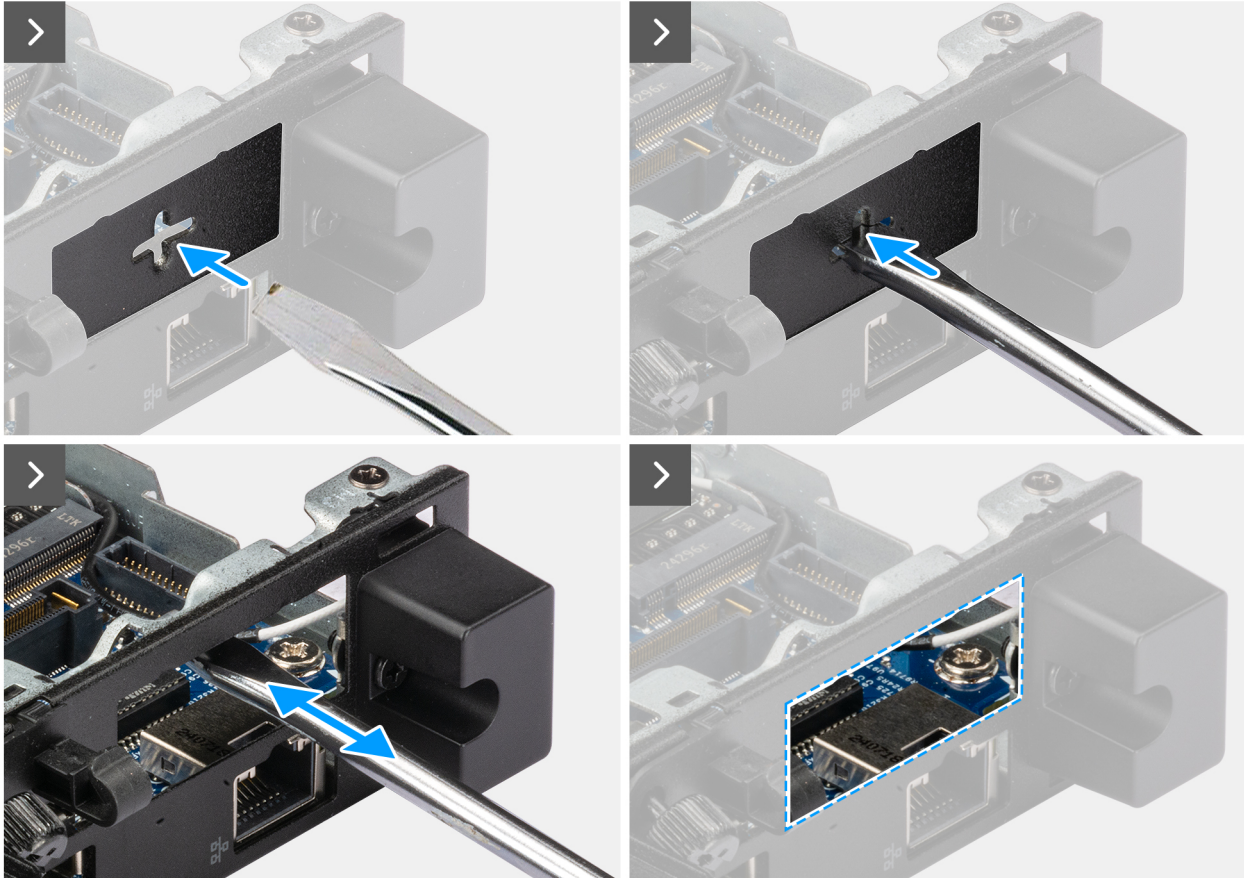
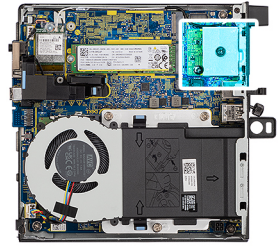
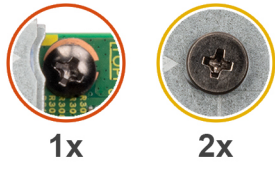

Figure 60. Installing fiber optic port module

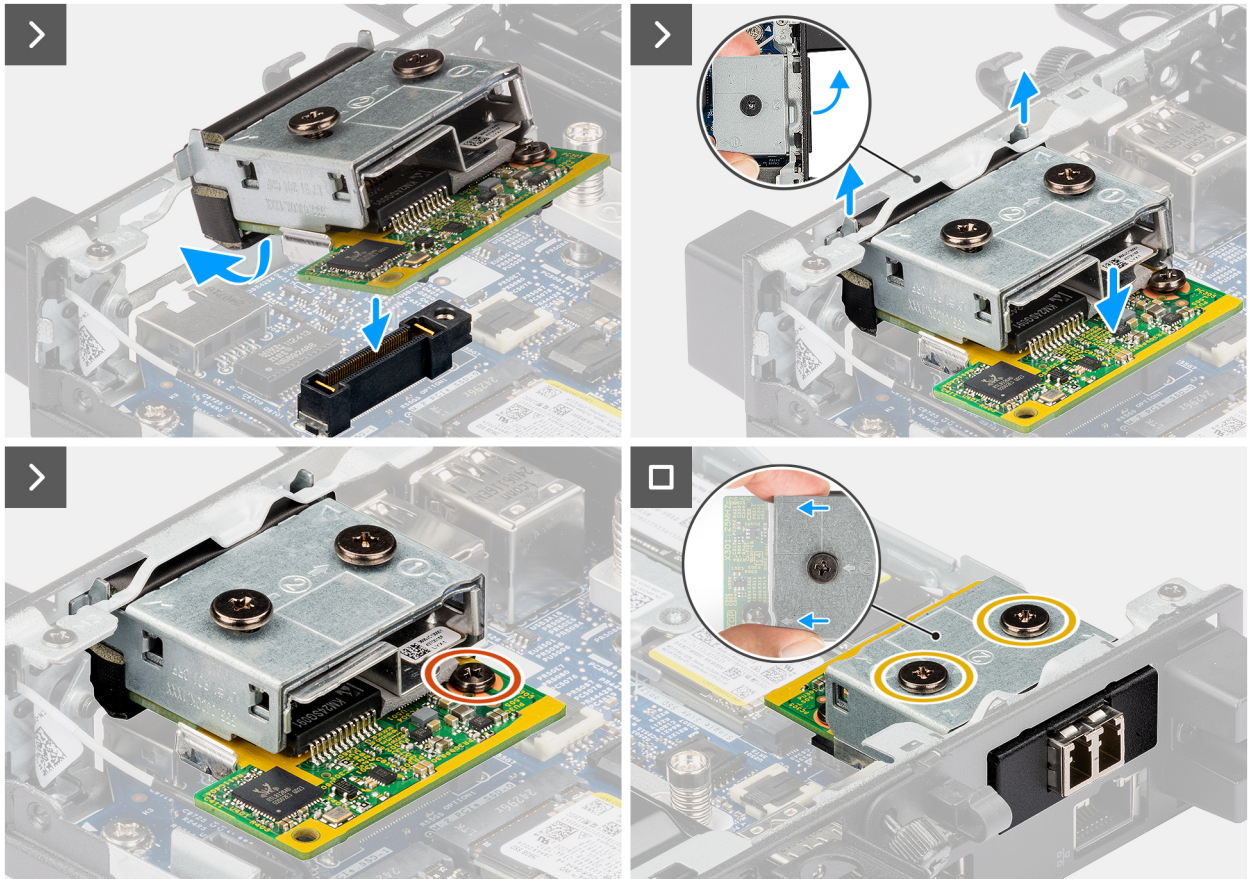

Figure 61. Installing fiber optic port module

1. **NOTE:** This step applies if you are upgrading a computer with no existing I/O module.

To remove the knock-out port cover, insert a flat-head screwdriver in the hole of the port cover from the outside of the computer. Push the knock-out port cover to release it, and then remove it out from the computer.

2. Insert the fiber optic port module into its slot at the back panel of the computer.

NOTE: Ensure that the tabs on the fiber optic port module align with the triangles that are engraved on the mounting point on the chassis.

3. Connect the fiber optic port module to the connector (OPTION) on the system board.

4. Tighten the two captive screws to secure the fiber optic port module to the chassis.

1. Install the [side cover](#).

2. Follow the procedure in [After working inside your computer](#).

Removing and installing Field Replaceable Units (FRUs)

The replaceable components in this chapter are Field Replaceable Units (FRUs).

CAUTION: The information in this removing and installing FRUs section is intended for authorized service technicians only.

CAUTION: To avoid any potential damage to the component or loss of data, Dell Technologies recommends that an authorized service technician replaces the Field Replaceable Units (FRUs).

CAUTION: Your warranty does not cover damages that may occur during FRU repairs that are not authorized by Dell Technologies.

NOTE: The images in this document may differ from your computer depending on the configuration you ordered.

Heat sink

Removing the heat sink

CAUTION: The information in this section is intended for authorized service technicians only.

1. Follow the procedure in [Before working inside your computer](#).
2. Remove the [side cover](#).
3. Remove the [fan](#).

NOTE: The heat sink may become hot during normal operation. Allow sufficient time for the heat sink to cool before you touch it.

NOTE: For maximum cooling of the processor, do not touch the heat-transfer areas on the heat sink. The oils in your skin can reduce the heat transfer capability of the thermal paste.

The following images indicate the location of the heat sink and provide a visual representation of the removal procedure.

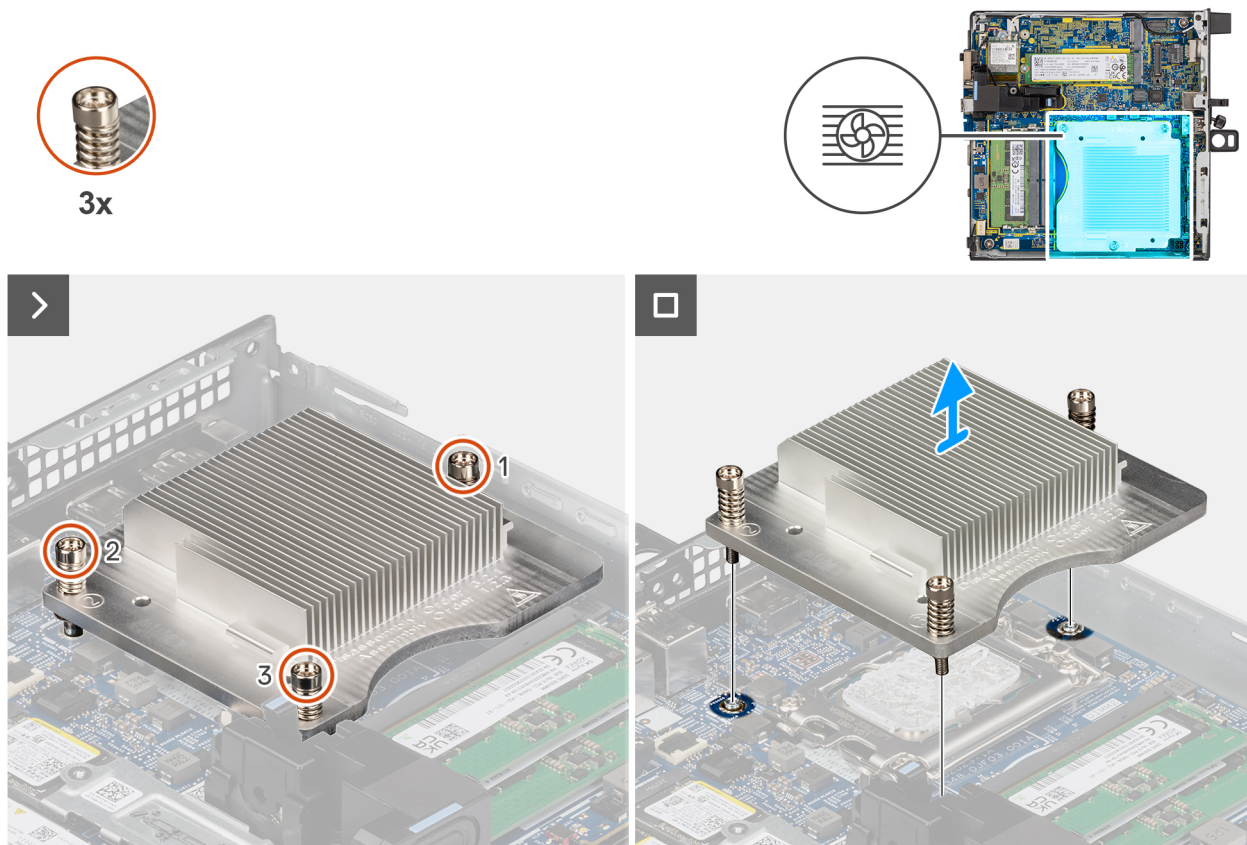

Figure 62. Removing the heat sink

1. In reverse sequential order (3->2->1), loosen the three captive screws that secure the heat sink to the system board.
2. Lift the heat sink off the system board.

Installing the heat sink

⚠ CAUTION: The information in this section is intended for authorized service technicians only.

If you are replacing a component, remove the existing component before performing the installation process.

📄 NOTE: If either the processor or the heat sink is replaced, use the thermal paste that is provided in the kit to ensure that thermal conductivity is achieved.

The following images indicate the location of the heat sink and provide a visual representation of the installation procedure.



3x

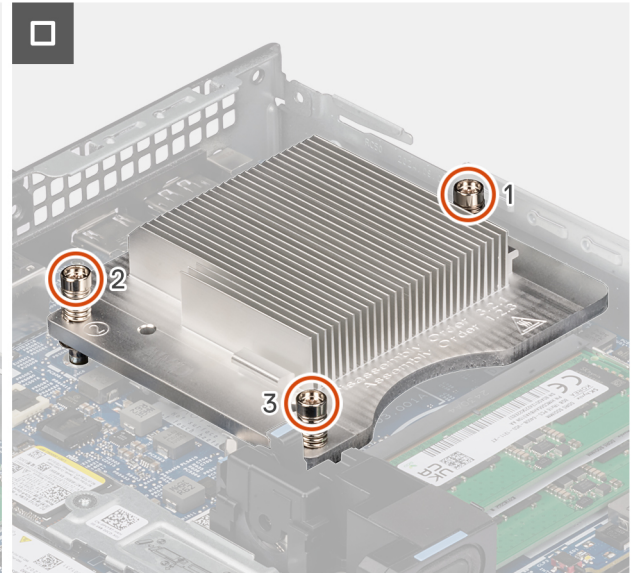
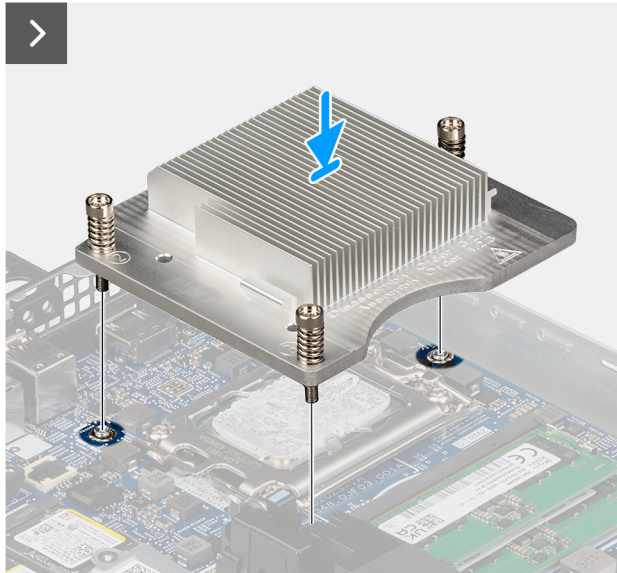
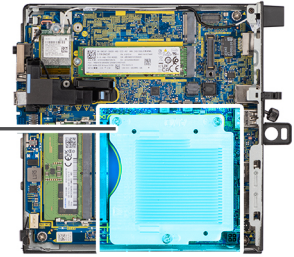

Figure 63. Installing the heat sink

1. Place the heat sink on the system board.
 2. Align the screw holes on the heat sink with the screw holes on the system board.
 3. In sequential order (1->2->3), tighten the three captive screws that secure the heat sink to the system board.
1. Install the [fan](#).
 2. Install the [side cover](#).
 3. Follow the procedure in [After working inside your computer](#).

Internal antenna module

Removing the antenna module (white cable)

1. Follow the procedure in [Before working inside your computer](#).
2. Remove the [side cover](#).
3. Remove the [wireless card](#).

The following images indicate the location of the antenna module (white cable) and provide a visual representation of the removal procedure.

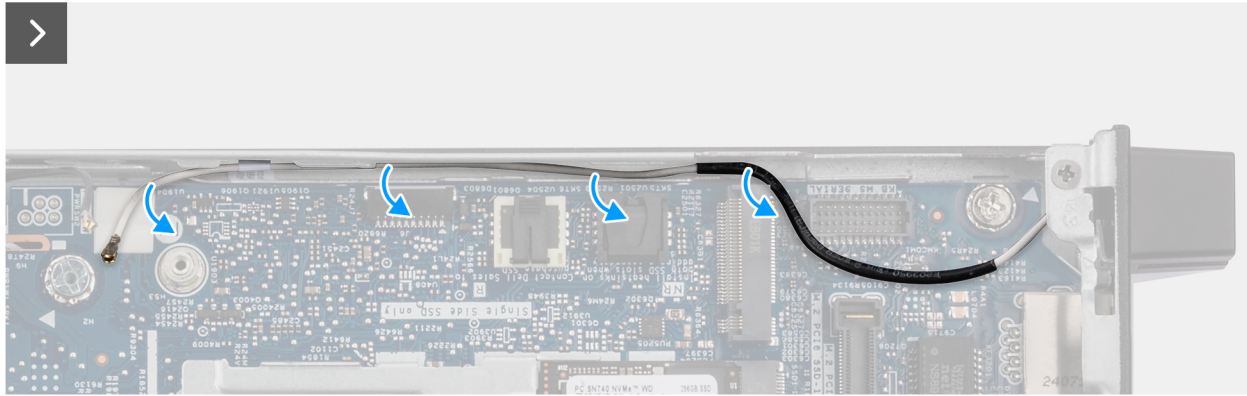
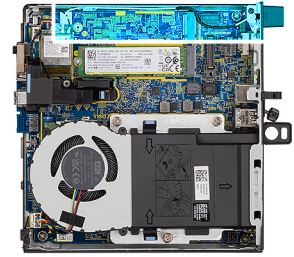

Figure 64. Removing the antenna module (white cable)

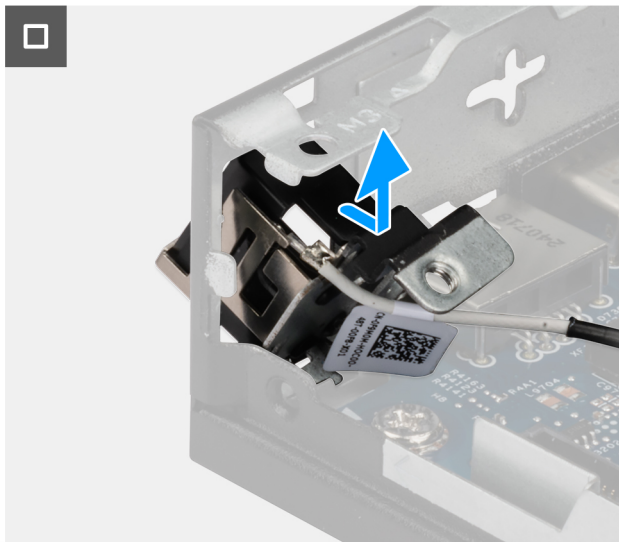
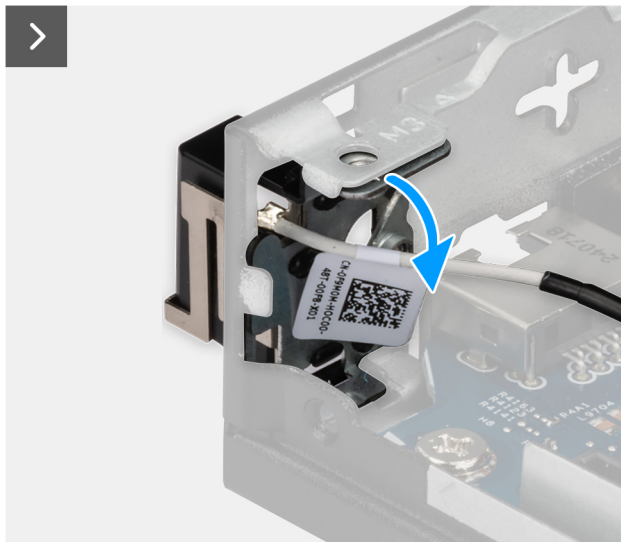

Figure 65. Removing the antenna module (white cable)

1. Remove the white antenna cable from the routing guides on the chassis and system board.
2. Loosen the captive screw that secures the antenna module cover to the antenna module (white cable).
3. Remove the antenna module cover from the chassis.
4. Remove the screw (M3x3) that secures the antenna module to the chassis.
5. Gently push the antenna module downwards, allowing it to slide through its slot on the chassis.
6. Pull the antenna module and lift it away from the chassis.

Installing the antenna module (white cable)

If you are replacing a component, remove the existing component before performing the installation process.

The following images indicate the location of the antenna module (white cable) and provide a visual representation of the installation procedure.

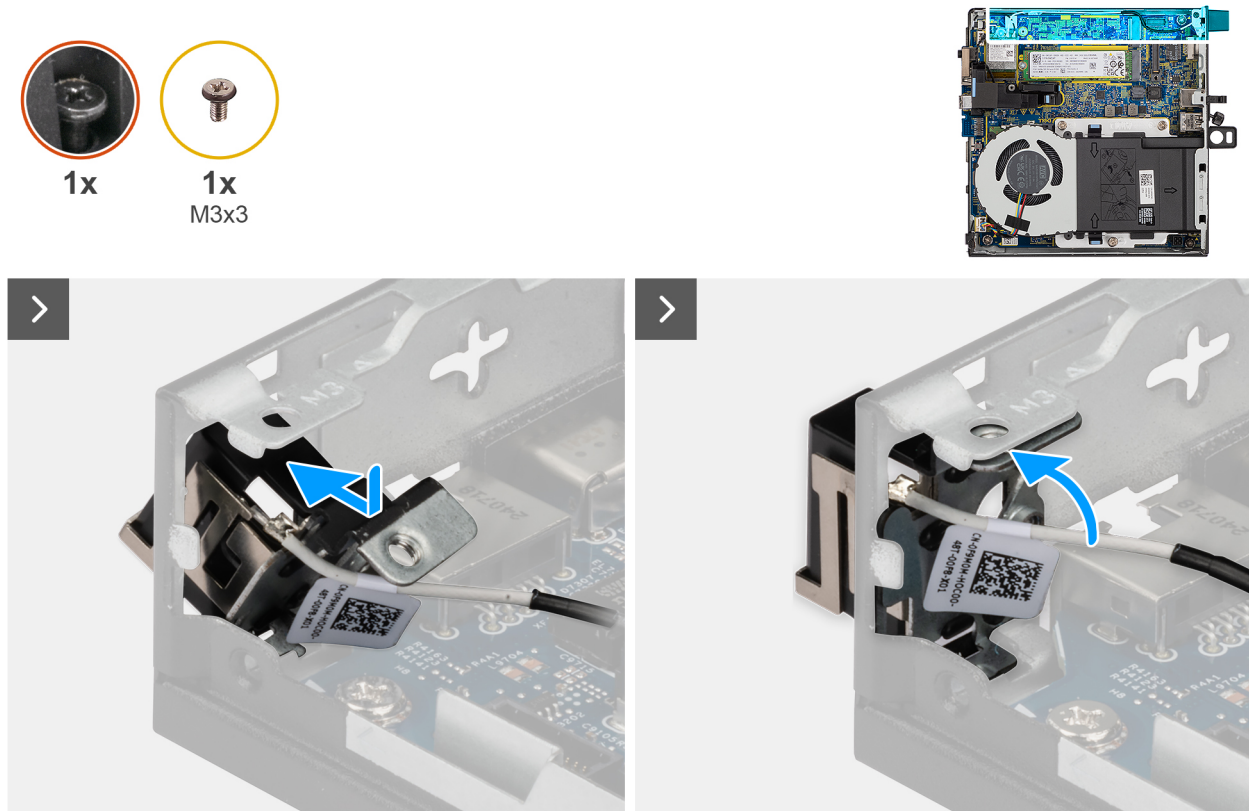

Figure 66. Installing the antenna module (white cable)

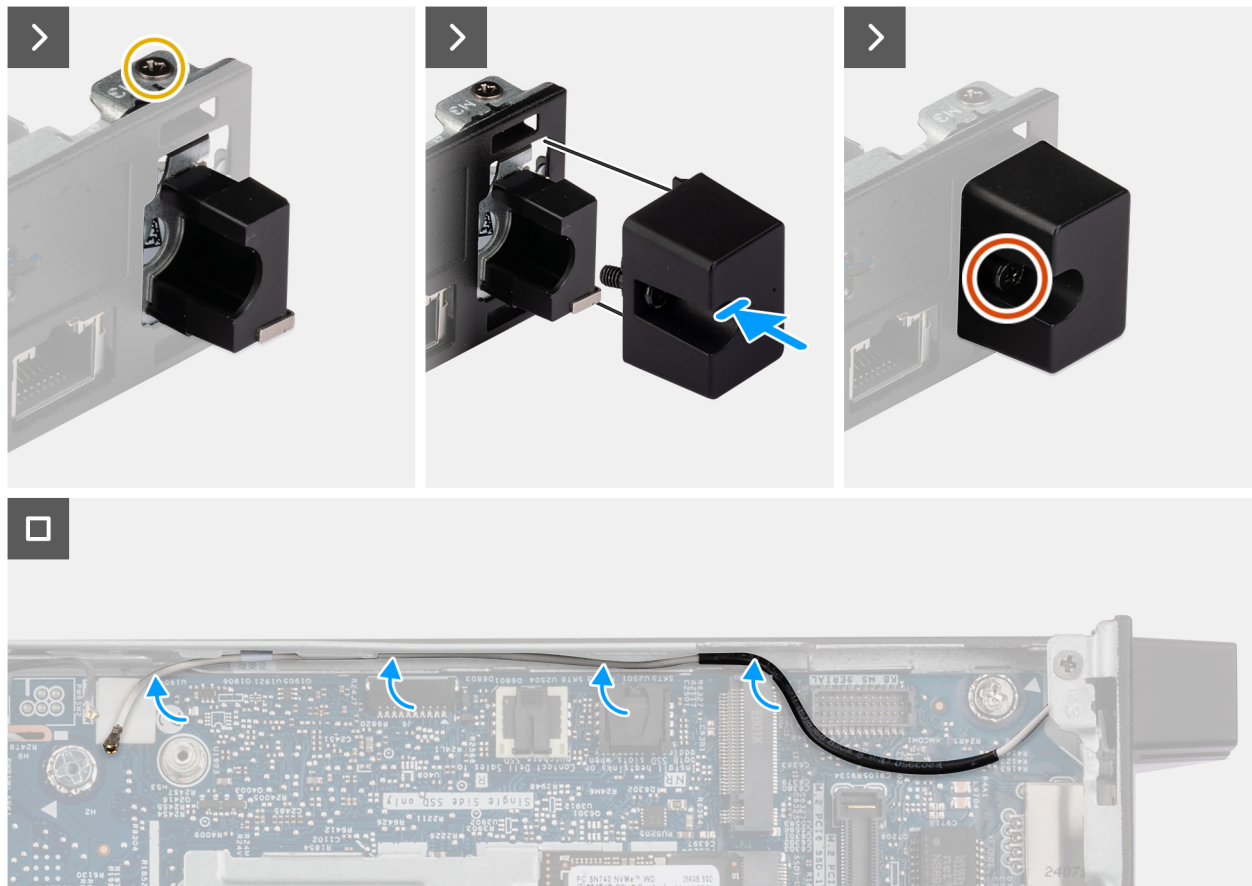

Figure 67. Installing the antenna module (white cable)

1. Place the antenna module at a certain angle and push it into the slot on the chassis.
 2. Align the screw hole and captive screw on the antenna module to the screw holes on the chassis.
 3. Replace the screw (M3x3) to secure the antenna module to the chassis.
 4. Replace the antenna module cover into its slot on the chassis.
 5. Tighten the captive screw to secure the antenna module cover to the chassis.
 6. Route the white antenna cable through the routing guides on the chassis and system board.
1. Install the [wireless card](#).
 2. Install the [side cover](#).
 3. Follow the procedure in [After working inside your computer](#).

Removing the antenna module (black cable)

1. Follow the procedure in [Before working inside your computer](#).
2. Remove the [side cover](#).
3. Remove the [wireless card](#).

The following images indicate the location of the wireless antenna module (black cable) and provide a visual representation of the removal procedure.



1x
M3x3

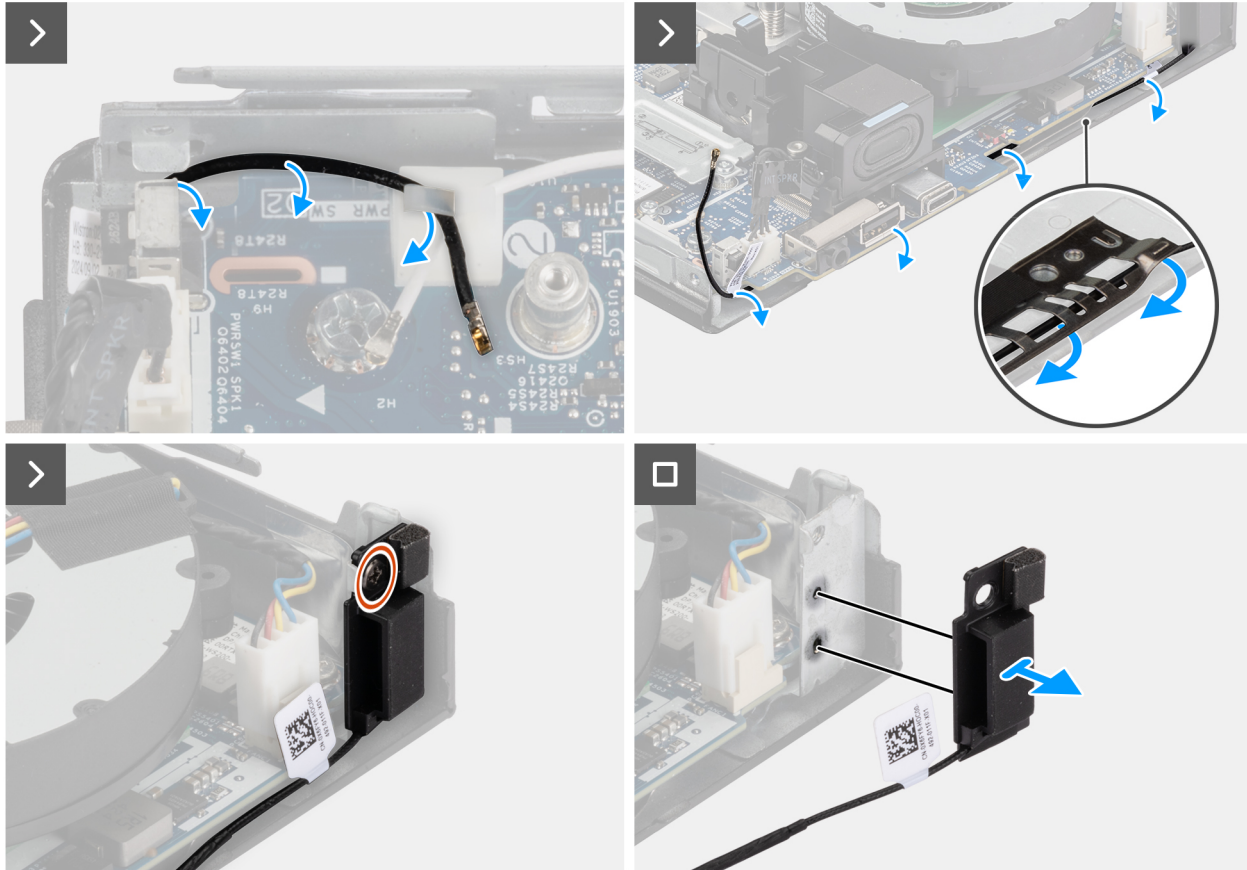
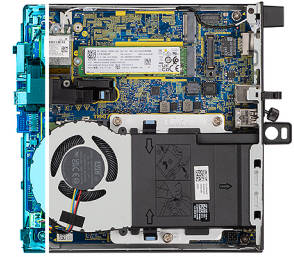

Figure 68. Removing the antenna module (black cable)

1. Remove the antenna cable from the routing guides on the chassis.
2. Remove the screw (M3x3) that secures the antenna module to the chassis.
3. Lift the antenna module away from the chassis.

Installing the antenna module (black cable)

If you are replacing a component, remove the existing component before performing the installation process.

The following images indicate the location of the antenna module (black cable) and provide a visual representation of the installation procedure.



1x
M3x3

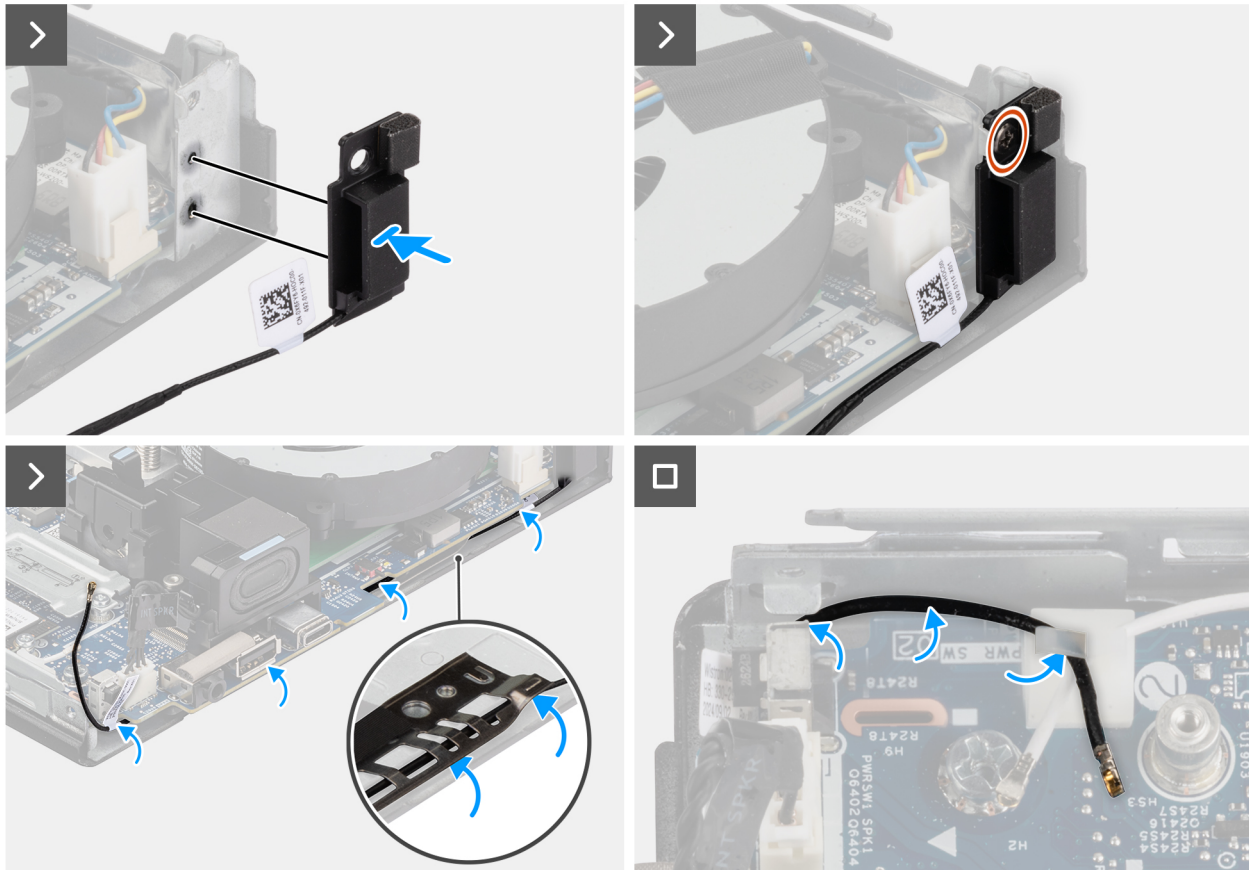
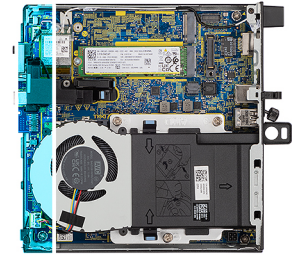

Figure 69. Installing the antenna module (black cable)

1. Align the tabs on the antenna module with the holes on the chassis and place it on the chassis.
2. Replace the screw (M3x3) that secures the antenna module to the chassis.
3. Using a plastic scribe, route the black antenna cable under the EMI shield below the system board on the chassis.

⚠ CAUTION: Do not press the intrusion switch while routing the black antenna cable under the EMI shield.

4. Route the black antenna cable through the routing guides on the system board.

1. Install the [wireless card](#).
2. Install the [side cover](#).
3. Follow the procedure in [After working inside your computer](#).

Processor

Removing the processor

⚠ CAUTION: The information in this section is intended for authorized service technicians only.

1. Follow the procedure in [Before working inside your computer](#).
2. Remove the [side cover](#).
3. Remove the [fan](#).
4. Remove the [heat sink](#).

NOTE: The heat sink may become hot during normal operation. Allow sufficient time for the heat sink to cool before you touch it.

NOTE: For maximum cooling of the processor, do not touch the heat-transfer areas on the heat sink. The oils in your skin can reduce the heat transfer capability of the thermal grease.

The following images indicate the location of the processor and provide a visual representation of the removal procedure.

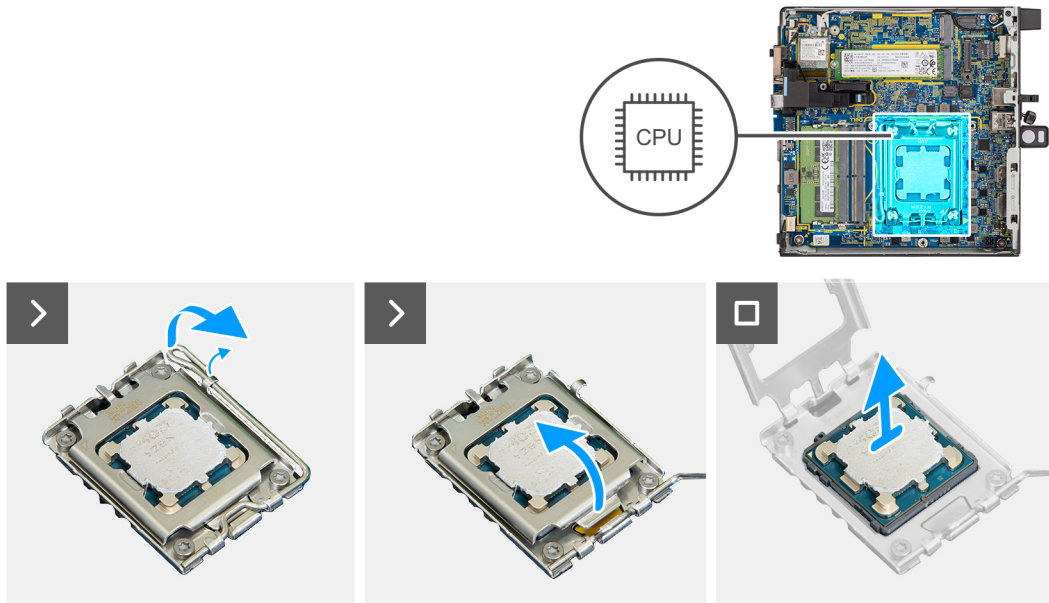

Figure 70. Removing the processor

1. Press the release lever down and then push it away from the processor to release it from the securing tab.
2. Extend the release lever all the way to ensure that the processor cover is open completely.

CAUTION: When removing the processor, do not touch any of the pins inside the socket or allow any objects to fall on the pins in the socket.

3. Gently lift the processor from the processor socket.

Installing the processor

CAUTION: The information in this section is intended for authorized service technicians only.

If you are replacing a component, remove the existing component before performing the installation process.

NOTE: If either the processor or the heat sink is replaced, use the thermal grease that is provided in the kit to ensure that thermal conductivity is achieved.

The following images indicate the location of the processor and provide a visual representation of the installation procedure.

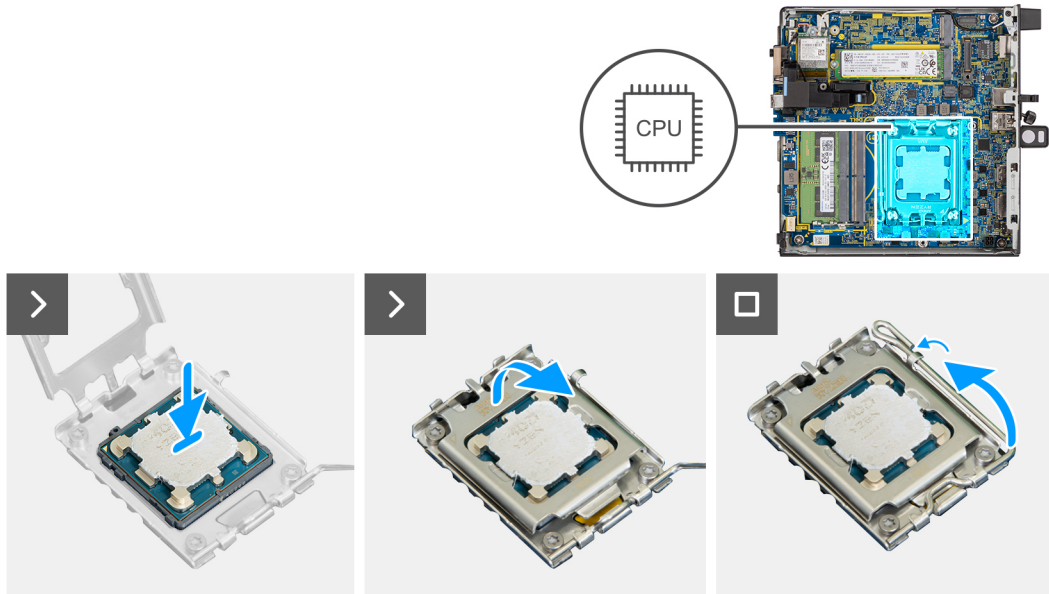

Figure 71. Installing the processor

1. Align the notches on the processor with the tabs on the processor socket and place the processor in the processor socket.

CAUTION: Ensure that the processor-cover notch is positioned underneath the alignment post.

NOTE: The pin-1 corner of the processor has a triangle that aligns with the triangle on the pin-1 corner on the processor socket. When the processor is properly seated, all four corners are aligned at the same height. If one or more corners of the processor are higher than the others, the processor is not seated properly.

2. When the processor is fully seated in the socket, close the processor-socket cover.
3. Push the release-lever down and place it under the tab on the processor socket.
1. Install the [heat sink](#).
2. Install the [fan](#).
3. Install the [side cover](#).
4. Follow the procedure in [After working inside your computer](#).

Speaker holder

Removing the speaker holder

1. Follow the procedure in [before working inside your computer](#).
2. Remove the [side cover](#).
3. Remove the [speaker](#).

The following image indicates the location of the speaker holder and provides a visual representation of the removal procedure.



1x
M3x5

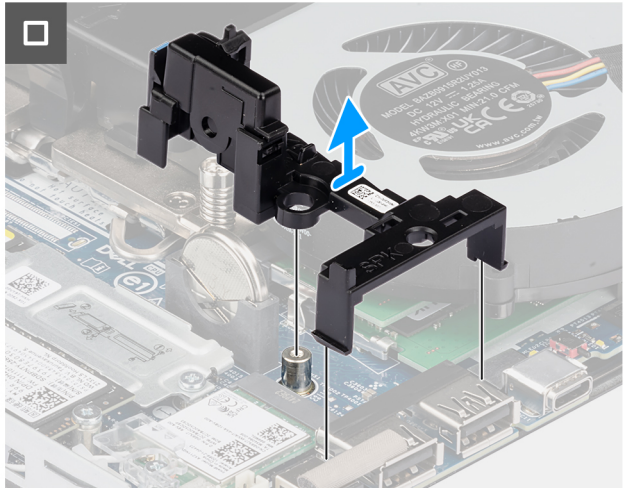
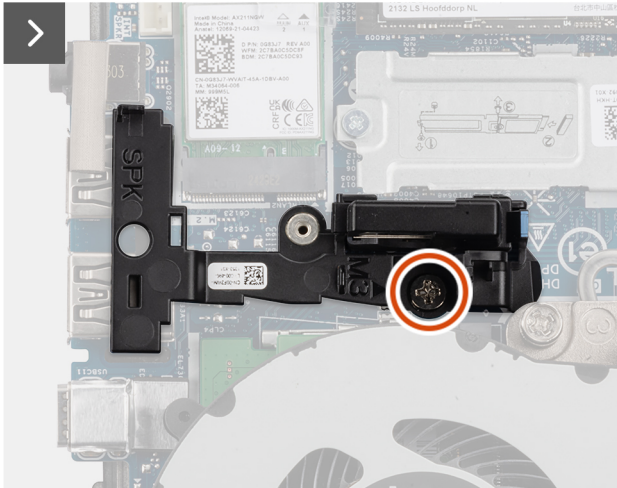
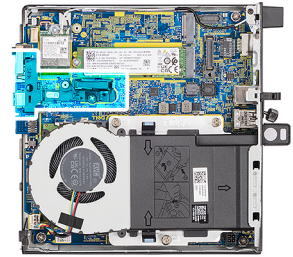

Figure 72. Removing the speaker holder

1. Remove the screw (M3x5) that secures the speaker holder to the system board.
2. Lift the speaker holder away from the system board.

Installing the speaker holder

If you are replacing a component, remove the existing component before performing the installation procedure.

The following image indicates the location of the speaker holder and provides a visual representation of the installation procedure.



1x
M3x5

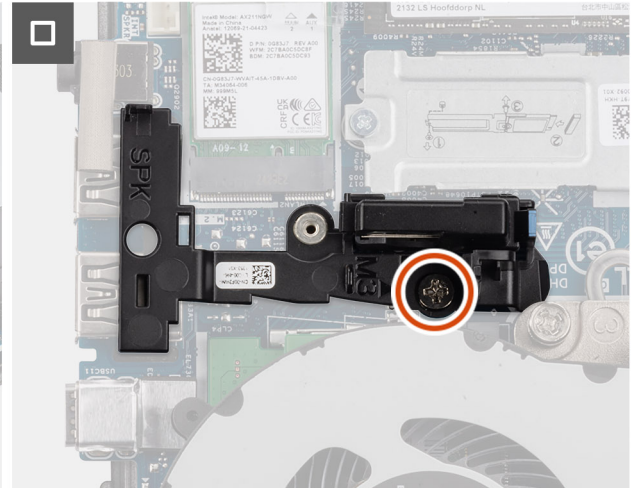
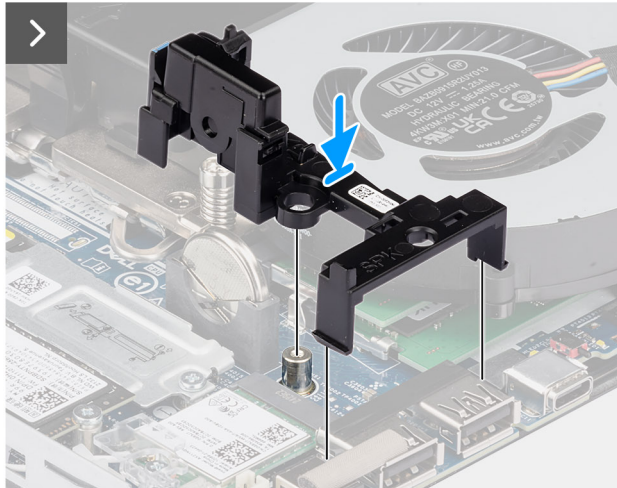
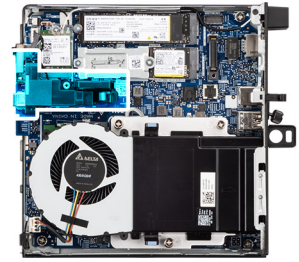

Figure 73. Installing the speaker holder

1. Align and insert the speaker holder into the slots on the system board and press it until the release tab clicks.
2. Replace the screw (M3x5) to secure the speaker holder to the system board.
1. Install the [speaker](#).
2. Install the [side cover](#).
3. Follow the procedure in [after working inside your computer](#).

System board

Removing the system board

⚠ CAUTION: The information in this section is intended for authorized service technicians only.

1. Follow the procedure in [Before working inside your computer](#).
2. Remove the [external puck antenna](#), if applicable.
3. Remove the [side cover](#).
4. Remove the [speaker](#).
5. Remove the [coin-cell battery](#).
6. Remove the [M.2 2230 solid-state drive](#) or [M.2 2280 solid-state drive](#) in single SSD configuration, if applicable.
7. Remove the [M.2 2230 solid-state drive](#) or [M.2 2280 solid-state drive](#) in dual SSD configuration, if applicable.
8. Remove the [wireless card](#).
9. Remove the [fan](#).
10. Remove the [memory](#).
11. Remove the [heat sink](#).
12. Remove the [processor](#).
13. Remove the optional input/output module, whichever is applicable.
 - [Dual USB 3.2 Gen 2 ports module](#)
 - [USB Type-C port module](#)
 - [DisplayPort module](#)

- HDMI port module
- VGA port module
- PS2 port module
- Serial port module
- Fiber optic port module

14. Remove the [speaker holder](#).

The following images indicate the system board connectors.

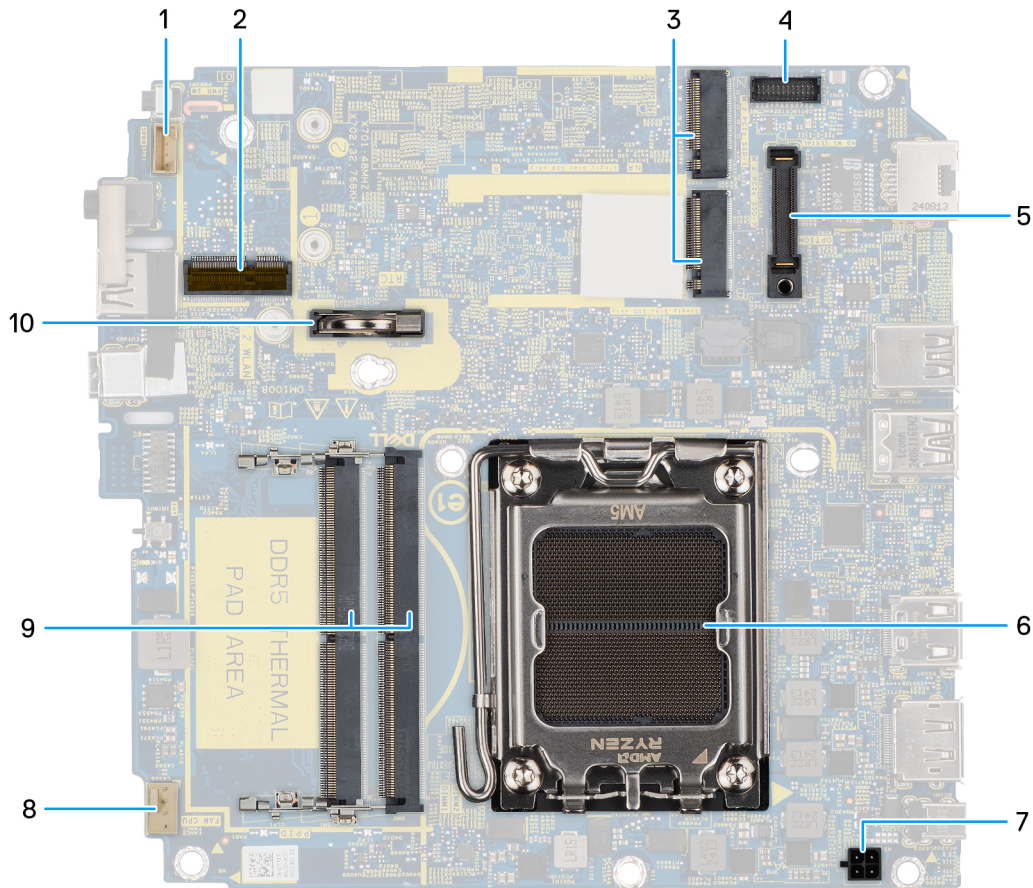

Figure 74. System board connectors

1. Speaker connector (INT SPK)
2. Wireless card slot (M.2 WLAN)
3. M.2 Solid-state drive slots (M.2 PCIe SSD-0 and M.2 PCIe SSD-1)
4. Optional PS/2, serial port connector (KB MS SERIAL)
5. Optional port connector (OPTION)
6. Processor socket
7. Power button connector (POWERIN)
8. Fan connector (FAN CPU)
9. Memory-module slots (DIMM1 and DIMM2)
10. Coin-cell battery

The following images indicate the location of the system board and provide a visual representation of the removal procedure.



3x
M3x5



1x
M3x4

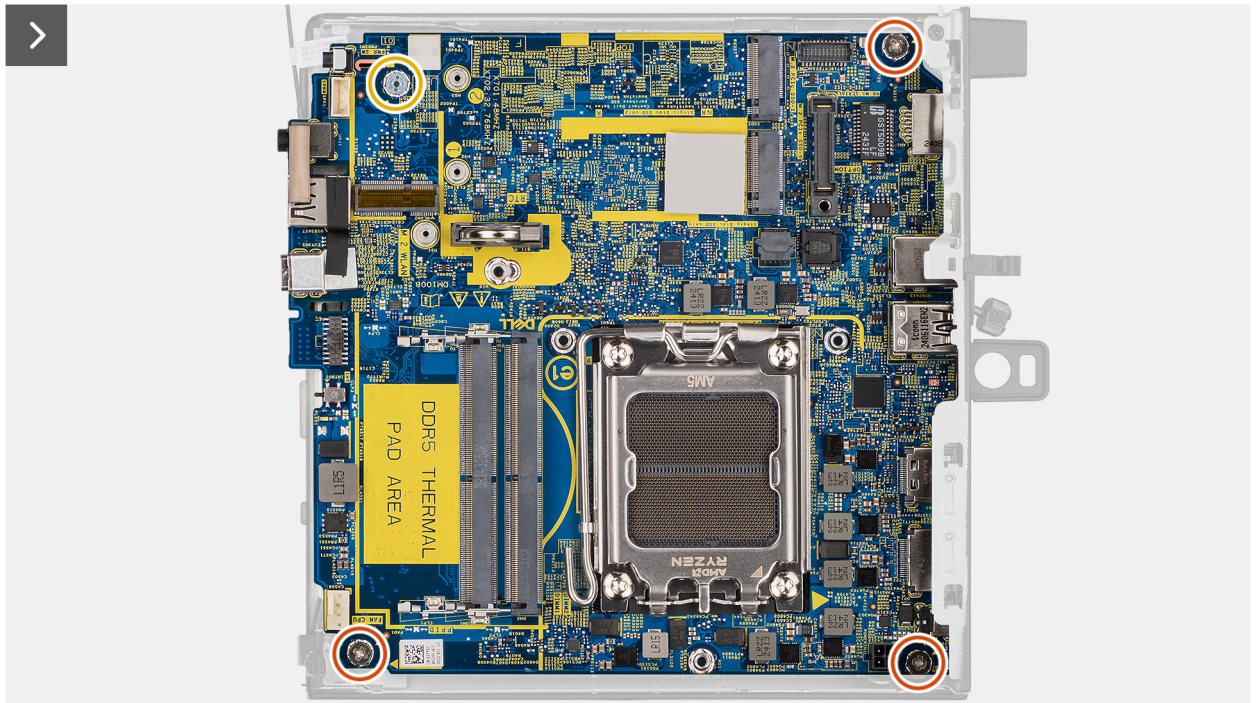
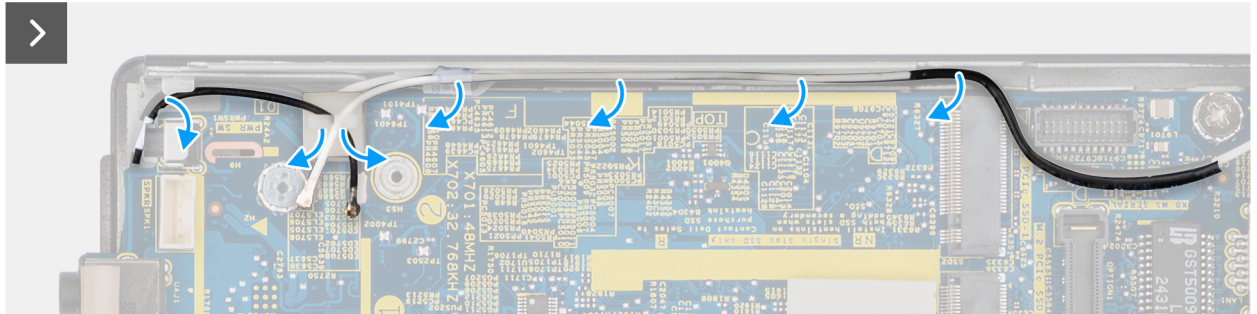
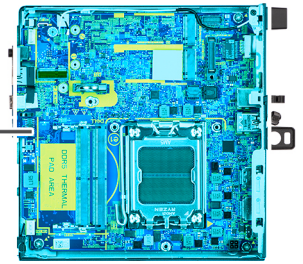

Figure 75. Removing the system board

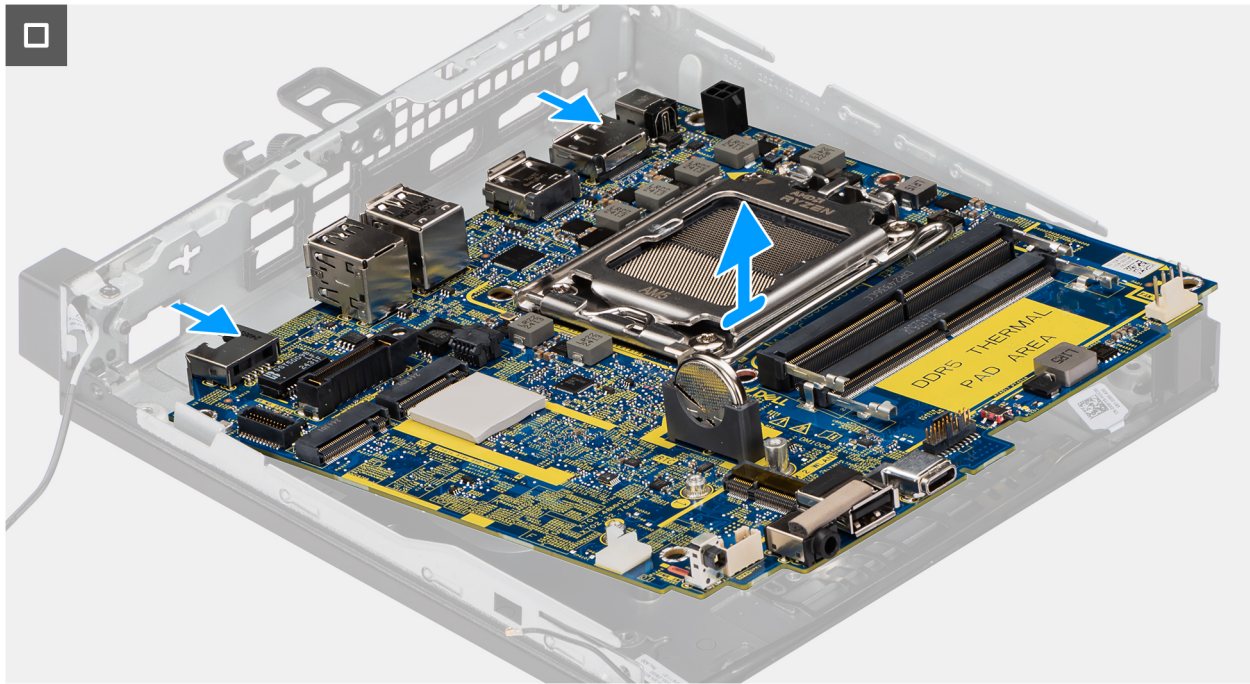

Figure 76. Removing the system board

1. Remove the wireless-card cables from their routing guides on the system board.
2. Remove the three screws (M3x5) that secure the system board to the chassis.
3. Remove the screw mount (M3x4) that secure the system board to the chassis.
4. Lift the system board at an angle and remove it from the chassis.

Installing the system board

CAUTION: The information in this section is intended for authorized service technicians only.

If you are replacing a component, remove the existing component before performing the installation process.

The following images indicate the system board connectors.

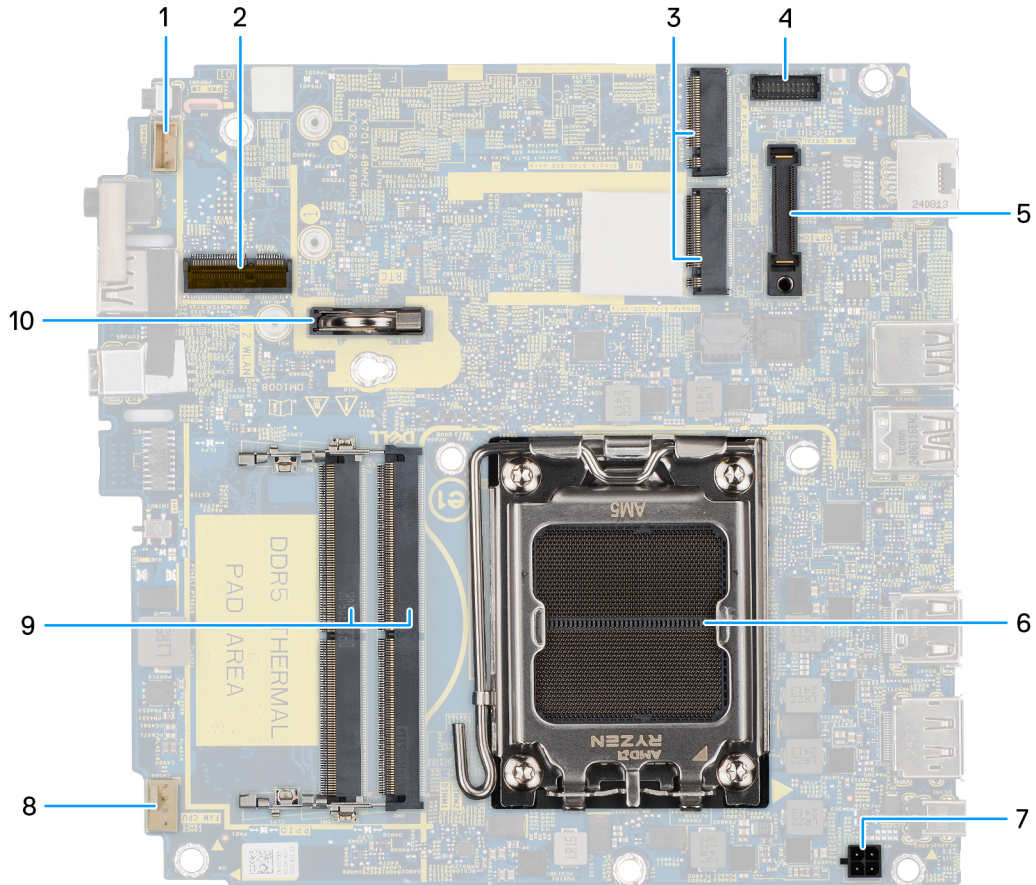

Figure 77. System board connectors

1. Speaker connector (INT SPK)
2. Wireless card slot (M.2 WLAN)
3. M.2 Solid-state drive slots (M.2 PCIe SSD-0 and M.2 PCIe SSD-1)
4. Optional PS/2, serial port connector (KB MS SERIAL)
5. Optional port connector (OPTION)
6. Processor socket
7. Power adapter connector (POWERIN)
8. Fan connector (FAN CPU)
9. Memory-module slots (DIMM1 and DIMM2)
10. Coin-cell battery

The following images indicate the location of the system board and provide a visual representation of the installation procedure.



3x
M3x5



1x
M3x4

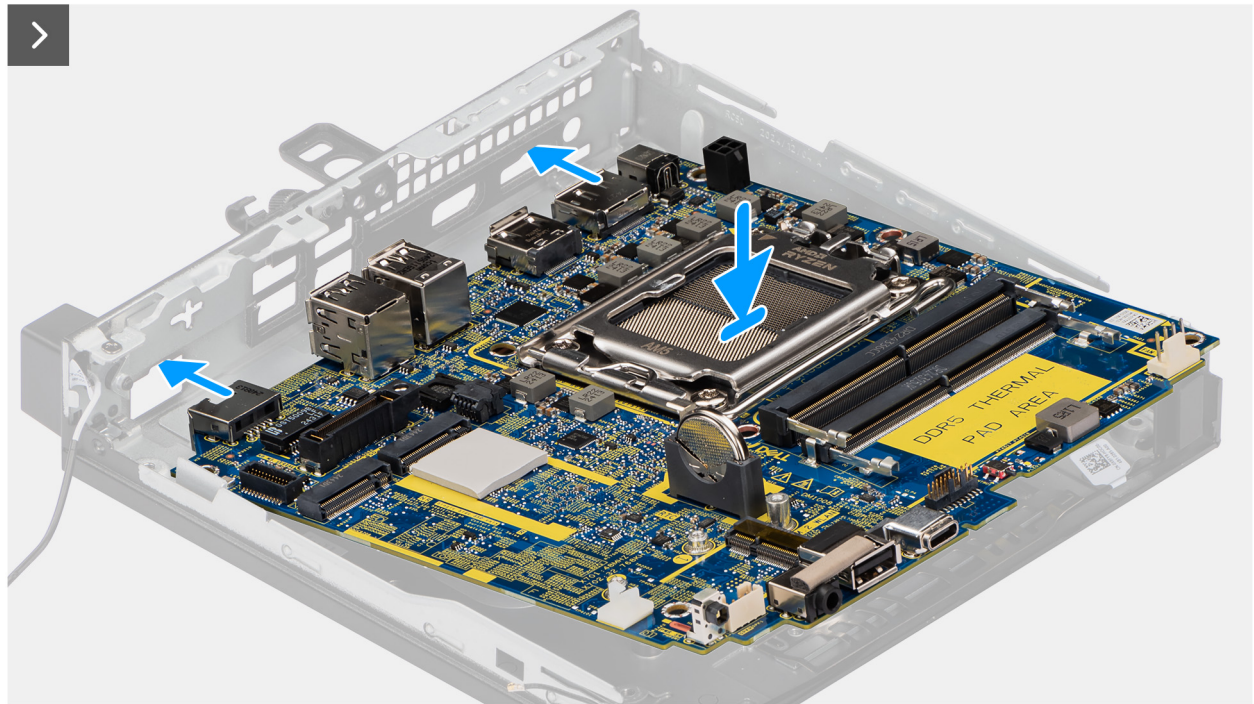
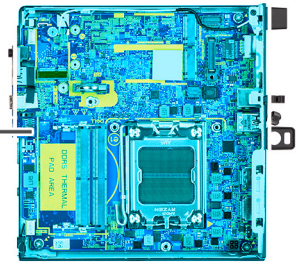

Figure 78. Installing the system board

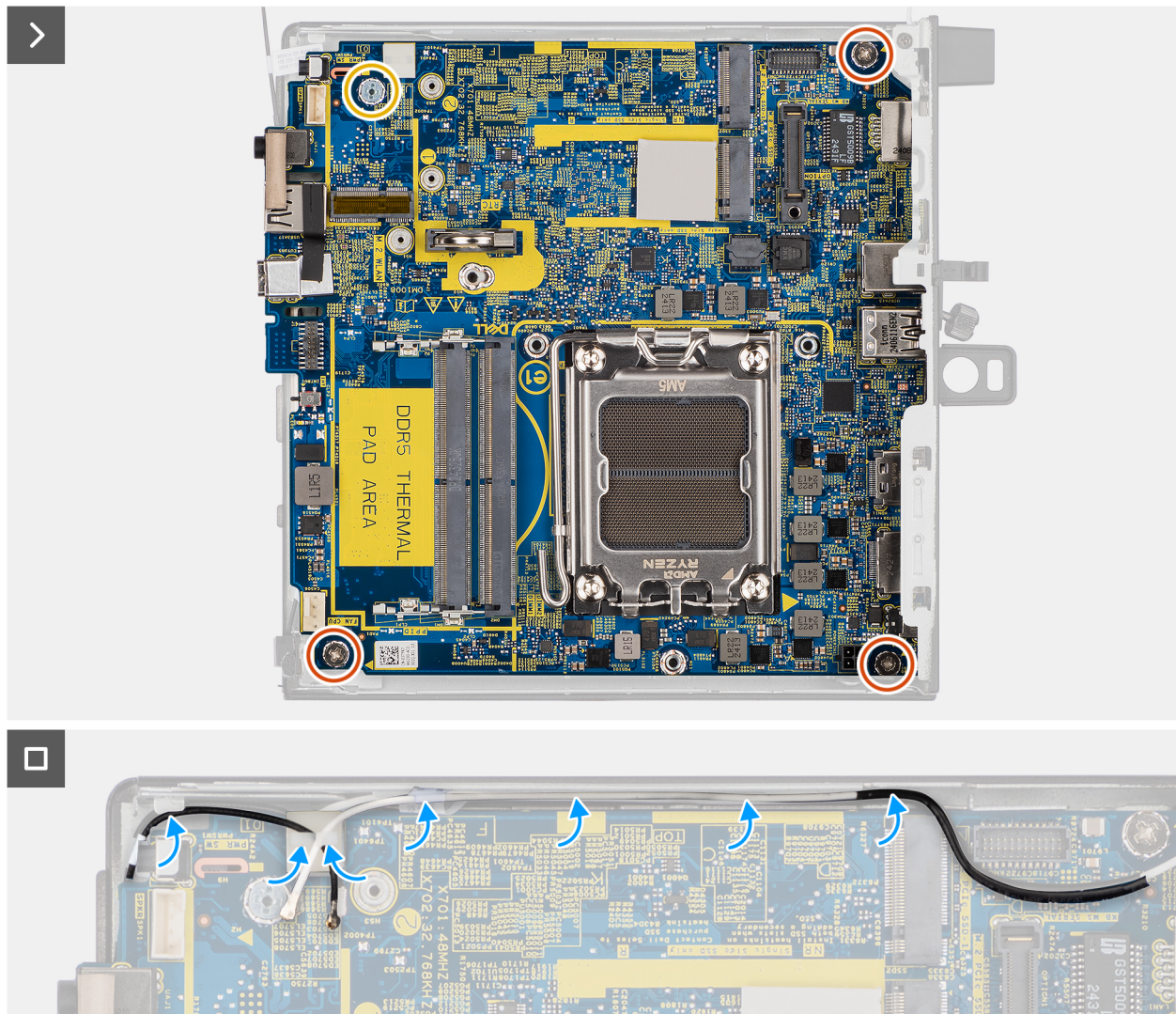

Figure 79. Installing the system board

1. Align and lower the system board into the chassis until the standoff points at the back of the system board align with those on the chassis.
 2. Replace the screw mount (M3x4) that secure the system board to the chassis.
 3. Replace the three screws (M3x5) that secure the system board to the chassis.
 4. Rout the wireless-card cables into their routing guides on the system board.
1. Install the [speaker holder](#).
 2. Install the optional input/output module, whichever is applicable.
 - [Dual USB 3.2 Gen 2 ports module](#)
 - [USB Type-C port module](#)
 - [DisplayPort module](#)
 - [HDMI port module](#)
 - [VGA port module](#)
 - [PS2 port module](#)
 - [Serial port module](#)
 - [Fiber optic port module](#)
 3. Install the [processor](#).
 4. Install the [heat sink](#).
 5. Install the [memory](#).
 6. Install the [fan](#).
 7. Install the [wireless card](#).

8. Install the [M.2 2230 solid-state drive](#) or [M.2 2280 solid-state drive](#) in single SSD configuration, if applicable.
9. Install the [M.2 2230 solid-state drive](#) or [M.2 2280 solid-state drive](#) in dual SSD configuration, if applicable.
10. Install the [coin-cell battery](#).
11. Install the [speaker](#).
12. Install the [side cover](#).
13. Install the [external puck antenna](#), if applicable.
14. Follow the procedure in [After working inside your computer](#).

Software

This chapter details the supported operating systems along with instructions on how to install the drivers.

Operating system

Your Dell Pro Micro QCM1255 supports the following operating systems:

- Windows 11 Home
- Windows 11 Pro
- Windows 11 Pro National Education
- Ubuntu Linux 24.04 LTS, 64-bit

Drivers and downloads

When troubleshooting, downloading, or installing drivers, it is recommended that you read the [Dell Knowledge Base article Drivers and Downloads FAQs](#).

BIOS Setup

CAUTION: Certain changes can make your computer work incorrectly. Before you change the settings in BIOS Setup, it is recommended that you note down the original settings for future reference.

NOTE: Depending on the computer and the installed devices, the options that are listed in this section may differ.

Use BIOS Setup for the following purposes:

- Get information about the hardware installed in your computer, such as the amount of RAM and the capacity of the storage device.
- Change the system configuration information.
- Set or change user-selectable options such as the user password, enabling or disabling base devices, and configuring hard drive settings.

Entering BIOS Setup program

Turn on (or restart) your computer and press F2 immediately.

Navigation keys

NOTE: For most of the BIOS Setup options, changes that you make are recorded but do not take effect until you restart the computer.

Table 25. Navigation keys

Keys	Navigation
Up arrow	Moves to the previous field.
Down arrow	Moves to the next field.
Enter	Selects a value in the selected field (if applicable) or follows the link in the field.
Spacebar	Expands or collapses a drop-down list, if applicable.
Tab	Moves to the next focus area.
Esc	Moves to the previous page until you view the main screen. Pressing Esc in the main screen displays a message that prompts you to save any unsaved changes and restart the computer.

One time boot menu

To access the **one time boot menu**, turn on your computer, and then press F2 immediately.

NOTE: If your computer fails to enter the boot menu, restart the computer and press F2 immediately.

The one-time boot menu displays the devices that you can boot from, and also displays the option to start diagnostics. The boot menu options are:

- Removable Drive (if available)
- STXXXX Drive (if available)

NOTE: XXX denotes the SATA drive number.

- Optical Drive (if available)
- SATA Hard Drive (if available)
- Diagnostics

NOTE: Choosing **Diagnostics**, will display the **ePSA diagnostics** screen.

The **one time boot menu** also displays the option to access the System Setup screen.

F12 One Time Boot menu

To enter the One Time Boot menu, turn on or restart your computer, and then press F12 immediately.

NOTE: If you are unable to enter the One Time Boot menu, repeat the above action.

The One Time Boot menu displays the devices that you can boot from and also display the options to start diagnostics. The boot menu options are:

- Removable Drive (if available)
- STXXXX Drive (if available)

NOTE: XXXX denotes the SATA drive number.

- Optical Drive (if available)
- SATA Hard Drive (if available)
- Diagnostics

The One Time Boot menu screen also displays the option to access BIOS Setup.

System setup options

NOTE: Depending on your computer and its installed devices, the items that are listed in this section may or may not be displayed.

Table 26. System setup options—System information menu

Overview	
Dell Pro Micro QCM1255	
BIOS Version	Displays the BIOS version number.
Service Tag	Displays the Service Tag of the computer.
Asset Tag	Displays the Asset Tag of the computer.
Manufacture Date	Displays the manufacture date of the computer.
Ownership Date	Displays the ownership date of the computer.
Express Service Code	Displays the express service code of the computer.
Ownership Tag	Displays the Ownership Tag of the computer.
PROCESSOR	
Processor Type	Displays the processor type.
Maximum Clock Speed	Displays the maximum processor clock speed.
Minimum Clock Speed	Displays the minimum processor clock speed.
Core Count	Displays the number of cores on the processor.
Processor ID	Displays the processor identification code.

Table 26. System setup options—System information menu (continued)

Overview	
Processor L2 Cache	Displays the processor L2 Cache size.
Processor L3 Cache	Displays the processor L3 Cache size.
Microcode Version	Displays the microcode version.
MEMORY	
Memory Installed	Displays the total computer memory installed.
Memory Available	Displays the total computer memory available.
Memory Speed	Displays the memory speed.
Memory Technology	Displays the technology that is used for the memory.
DIMM 1 Size	Displays the DIMM 1 memory size.
DIMM 2 Size	Displays the DIMM 2 memory size.
DEVICES	
Video Controller	Displays the video controller type of the computer.
Video Memory	Displays the video memory information of the computer.
Wi-Fi Device	Displays the wireless device information of the computer.
Native Resolution	Displays the native resolution of the computer.
Video BIOS Version	Displays the video BIOS version of the computer.
Audio Controller	Displays the audio controller information of the computer.
Bluetooth Device	Displays the Bluetooth device information of the computer.
LOM MAC Address	Displays the LAN On Motherboard (LOM) MAC address of the computer.

Table 27. System setup options—Boot Configuration menu

Boot Configuration	
Boot Sequence	
Boot Sequence	Displays the boot sequence.
Enable PXE Boot Priority	Enables or disables the option to add a new PXE boot to the top of the Boot Sequence. By default, the OFF option is disabled.
Force PXE On Next Boot	Enables or disables the Force PXE feature on the next boot. By default, the Force PXE On Next Boot option is disabled.
Secure Boot	
Enable Secure Boot	Enable or disable the secure boot feature. By default, the OFF option is disabled.
Enable Microsoft UEFI CA	Enable or disable Microsoft UEFI Certificate Authority. By default, the ON option is enabled.  CAUTION: Disabling Microsoft UEFI CA could render your system being unable to boot. System graphics may not function, some devices may not function properly. The system could become unrecoverable.
Secure Boot Mode	Change the secure boot mode options. By default, the Deployed Mode option is enabled.

Table 27. System setup options—Boot Configuration menu (continued)

Boot Configuration	
Expert Key Management	
Enable Custom Mode	Enable or disable custom mode. By default, the OFF option is disabled.
Custom Mode Key Management	Select the custom values for expert key management.

Table 28. System setup options—Integrated Devices menu

Integrated Devices	
Date/Time	Displays the current date in MM/DD/YYYY format and current time in HH:MM:SS AM/PM format.
Enable Audio	Enable or disable the integrated audio controller. By default, all the options are enabled.
USB Configuration	Enable or disable booting from USB mass storage devices through the boot sequence or boot menu. By default, all the options are enabled.
Front USB Configuration	Enable or disable the individual front USB ports. By default, all the options are enabled.
Rear USB Configuration	Enable or disable the individual rear USB ports. By default, all the options are enabled.
Dust Filter Maintenance	Enable or disable the dust filter maintenance. By default, the Disabled option is enabled.

Table 29. System setup options—Storage menu

Storage	
SATA/NVMe Operation	Enable or disable the operating mode of the integrated SATA hard drive controller. By default, the RAID On option is enabled.
Storage Interface	
Port Enablement	Enable or disable the onboard drives. By default, all the onboard drives are enabled.
M.2 PCIe SSD-0	Enable or disable the M.2 PCIe SSD-0 solid-state drive. By default, the ON option is enabled.
M.2 PCIe SSD-1	Enable or disable the M.2 PCIe SSD-1 solid-state drive. By default, the ON option is enabled.
SMART Reporting	
Enable SMART Reporting	Enable or disable Self-Monitoring, Analysis, and Reporting Technology (SMART) during computer startup. By default, the OFF option is disabled.
Drive Information	
M.2 PCIe SSD-0	
Type	Displays the M.2 PCIe SSD-0 type information of the computer.
Device	Displays the M.2 PCIe SSD-0 device information of the computer.

Table 29. System setup options—Storage menu (continued)

Storage	
Drive Information	
M.2 PCIe SSD-1	
Type	Displays the M.2 PCIe SSD-1 type information of the computer.
Device	Displays the M.2 PCIe SSD-1 device information of the computer.

Table 30. System setup options—Display menu

Display	
Primary Display	Determines the primary display when multiple controllers are available on the computer. By default, the Auto option is enabled.
Full Screen Logo	Enable or disable full screen logo. By default, the OFF option is disabled.

Table 31. System setup options—Connection menu

Connection	
Network Controller Configuration	
Integrated NIC	Controls the on-board LAN controller. By default, the Enabled with PXE option is selected.
Wireless Device Enable	
WLAN	Enable or disable the internal WLAN device. By default, the WLAN option is selected.
Bluetooth	Enable or disable the internal Bluetooth device. By default, the Bluetooth option is selected.
Enable UEFI Network Stack	Enable or disable UEFI Network Stack and controls the on-board LAN Controller. By default, the Auto Enabled option is selected.
HTTP(s) Boot Feature	
HTTP(s) Boot	Enable or disable the HTTP(s) Boot feature. By default, the ON option is enabled.
HTTP(s) Boot Mode	With Auto Mode, the HTTP(s) Boot extracts Boot URL from the DHCP. With Manual Mode, the HTTP(s) Boot reads Boot URL from the user-provided data. By default, the Auto Mode option is selected.

Table 32. System setup options—Power menu

Power	
Thermal Management	Select the heat management settings for the cooling fan and the processor, with respect to system performance, noise, and temperature. By default, the Optimized option is selected.
USB Wake Support	
Enable USB Wake Support	When enabled, you can use the USB devices like a mouse or keyboard to wake your computer from standby. By default, the ON option is enabled.

Table 32. System setup options—Power menu (continued)

Power	
Wake on Dell USB-C Dock	When enabled, you can use the Dell USB-C dock to wake your computer from standby. By default, the ON option is enabled.
AC Behavior	
AC Recovery	Allows you to determine what happens when AC power is restored after an unexpected loss of AC power. By default, the Power Off option is selected.
Block Sleep	Enables or disables the computer from entering Sleep (S3) mode in the operating system. By default, the OFF option is disabled.
Deep Sleep Control	Enable or disable the Deep Sleep mode support. By default, the Enabled in S4 and S5 option is selected.
Fan Control Override	Enable or disable the fan control override feature. By default, the OFF option is enabled.

Table 33. System setup options—Security menu

Security	
TPM 2.0 Security	
TPM 2.0 Security On	Enable or disable TPM 2.0 security options. By default, the ON option is enabled.
Attestation Enable	Enables to control whether the Trusted Platform Module (TPM) Endorsement Hierarchy is available to the operating system. By default, the ON option is enabled.
Key Storage Enable	Enables to control whether the Trusted Platform Module (TPM) Storage Hierarchy is available to the operating system. By default, the ON option is enabled.
Clear	Enables to clear the TPM owner information and returns the TPM to the default state. By default, the OFF option is enabled.
PPI Bypass for Clear Commands	Controls the TPM Physical Presence Interface (PPI). By default, the OFF option is enabled.
Chassis intrusion	Controls the chassis intrusion feature. By default, the Disabled option is enabled.
Data Wipe on Next Boot	
Start Data Wipe	Data Wipe is a secure wipe operation that deletes information from a storage device.  CAUTION: The secure Data Wipe operation deletes information in a way that it cannot be reconstructed. Commands such as delete and format in the operating system may remove files from showing up in the file system. However, they can be reconstructed through forensic means as they are still represented on the physical media. Data Wipe prevents this reconstruction and is not recoverable.

Table 33. System setup options—Security menu (continued)

Security	
	<p>When enabled, the data wipe option will prompt to wipe any storage devices that are connected to the computer on the next boot.</p> <p>By default, the OFF option is disabled.</p>
<p>Absolute®</p> <p>Absolute®</p>	<p>Absolute Software provides various cyber security solutions, some requiring software preloaded on Dell computers and integrated into the BIOS. To use these features, you must enable the Absolute BIOS setting and contact Absolute for configuration and activation.</p> <p>By default, the Enable Absolute option is enabled.</p> <p>For additional security, Dell Technologies recommends keeping the Absolute option enabled.</p> <p>NOTE: When the Absolute features are activated, the Absolute integration cannot be disabled from the BIOS setup screen.</p>
<p>UEFI Boot Path Security</p> <p>UEFI Boot Path Security</p>	<p>Enables or disables the computer to prompt the user to enter the Administrator password (if set) when booting to a UEFI boot path device from the F12 boot menu.</p> <p>By default, the Always Except Internal HDD option is selected.</p>
<p>Authenticated BIOS Interface</p> <p>Enable Authenticated BIOS Interface</p>	<p>Controls the authentication feature in the BIOS interface.</p> <p>By default, the OFF option is enabled.</p>
<p>Legacy Manageability Interface Access</p>	<p>Controls the access to Legacy Manageability Interface when enabled.</p>
<p>Firmware Device Tamper Detection</p> <p>Firmware Device Tamper Detection</p>	<p>Controls the Firmware Device Tamper Detection.</p> <p>By default, the Silent option is selected.</p>
<p>Clear Firmware Device Tamper Detection</p>	

Table 34. System setup options—Passwords menu

Passwords	
Admin Password	Set, change, or delete the administrator password.
System Password	Set, change, or delete the computer password.
M.2 PCIe SSD-0	Set, change, or delete the M.2 PCIe SSD-0 password.
Password Configuration	<p>The Password configuration page includes several options for changing the requirements of BIOS passwords. You can modify the minimum and maximum length of the passwords and require passwords to contain certain character classes (upper case, lower case, digit, special character).</p> <p>Dell Technologies recommends setting the minimum password length to at least eight characters.</p>
Upper Case Letter	<p>Reinforces password must have at least one upper case letter.</p> <p>By default, the OFF option is enabled.</p>
Lower Case Letter	<p>Reinforces password must have at least one lower case letter.</p> <p>By default, the OFF option is enabled.</p>

Table 34. System setup options—Passwords menu (continued)

Passwords	
Digit	Reinforces password must have at least one digit. By default, the OFF option is enabled.
Special Character	Reinforces password must have at least one special character. By default, the OFF option is enabled.
Minimum Characters	Set the minimum characters allowed for password. By default, the Minimum Characters value is set to 4.
Password Bypass	When enabled, this always prompts for computer and internal hard drive passwords when powered on from the off state. By default, the Disabled option is enabled.
Password Changes	
Enable Non-Admin Password Changes	The Enable Non-Admin Password Changes option in BIOS setup allows an end user to set or change the computer or hard drive passwords without entering the administrator password. This gives an administrator control over the BIOS settings but enables an end user to provide their own password. By default, the ON option is enabled. For additional security, Dell Technologies recommends keeping the Enable Non-Admin Password Changes option disabled.
Admin Setup Lockout	
Enable Admin Setup Lockout	The Enable Admin Setup Lockout option prevents an end user from even viewing the BIOS setup configuration without first entering the administrator password (if set). By default, the OFF option is disabled. For additional security, Dell Technologies recommends keeping the Enable Admin Setup Lockout option disabled.
Master Password Lockout	
Enable Master Password Lockout	The Master Password Lockout setting allows you to disable the Recovery Password feature. If the computer, administrator, or hard drive password is forgotten, the computer becomes unusable. i NOTE: When the owner password is set, the Master Password Lockout option is not available. i NOTE: When an internal hard drive password is set, it must first be cleared before Master Password Lockout can be changed. By default, the OFF option is disabled. Dell does not recommend enabling the Master Password Lockout unless you have implemented your own password recovery computer.
Allow Non-Admin PSID Revert	
Enable Allow Non-Admin PSID Revert	Controls access to the Physical Security ID (PSID) revert of NVMe hard-drives from the Dell Security Manager prompt. By default, the OFF option is disabled.

Table 35. System setup options—Update, Recovery menu

Update, Recovery	
BIOS Recovery from Hard Drive	Enables or disables the user to recover from certain corrupted BIOS conditions from a recovery file on the user primary hard drive or an external USB key.

Table 35. System setup options—Update, Recovery menu (continued)

Update, Recovery	
	<p>By default, the ON option is enabled.</p> <p>i NOTE: BIOS Recovery from Hard Drive is not available for self-encrypting drives (SED).</p> <p>i NOTE: BIOS recovery is designed to fix the main BIOS block and cannot work if the Boot Block is damaged. In addition, this feature cannot work in the event of EC corruption, ME corruption, or a hardware issue. The recovery image must exist on an unencrypted partition on the drive.</p>
BIOS Downgrade	
Allow BIOS Downgrade	<p>Controls flashing of the computer firmware to previous revisions.</p> <p>By default, the ON option is enabled.</p>
SupportAssist OS Recovery	
	<p>Enables or disables the boot flow for SupportAssist OS Recovery tool in the event of certain computer errors.</p> <p>By default, the ON option is enabled.</p>
BIOSConnect	
	<p>Enables or disables cloud Service operating system recovery if the main operating system fails to boot with the number of failures equal to or greater than the value specified by the Auto operating system Recovery Threshold setup option and local Service operating system does not boot or is not installed.</p> <p>By default, the ON option is enabled.</p>
Dell Auto OS Recovery Threshold	
	<p>Allows you to control the automatic boot flow for SupportAssist System Resolution Console and for Dell operating system Recovery Tool.</p> <p>By default, the value of 2 option is selected.</p>

Table 36. System setup options—System Management menu

System Management	
Service Tag	Display the Service Tag of the computer.
Asset Tag	<p>Creates a computer Asset Tag that can be used by an IT administrator to uniquely identify a particular computer.</p> <p>i NOTE: Once set in BIOS, the Asset Tag cannot be changed.</p>
Wake on LAN/WLAN	<p>Enables or disables the computer to turn on by special LAN signals.</p> <p>By default, the Disabled option is selected.</p>
Auto On Time	<p>Enable to set the computer to turn on automatically every day or on a preselected date and time. This option can be configured only if the Auto On Time is set to Everyday, Weekdays, or Selected Days.</p> <p>By default, the Disabled option is selected.</p>
SERR Messages	
Enable SERR Messages	<p>Enable or disable SERR (system error) messages.</p> <p>By default, the ON option is enabled.</p>
First Power On Date	
Set Ownership Date	<p>Set ownership date</p> <p>By default, the OFF option is enabled.</p>
Diagnostics	
OS Agent Requests	Enables OS agent request to schedule onboard diagnostics.

Table 36. System setup options—System Management menu (continued)

System Management	
	By default, the ON option is enabled.

Table 37. System setup options—Keyboard menu

Keyboard	
Numlock LED	
Enable Numlock LED	Enable or disable Numlock LED. By default, the ON option is enabled.
Device Configuration Hotkey Access	
Device Configuration Hotkey Access	Allows you to control whether you can access device configuration screens through hotkeys during computer startup. By default, the Enabled option is selected.

Table 38. System setup options—Pre-boot Behavior menu

Pre-boot Behavior	
Adapter Warnings	
Enable Adapter Warnings	Enables the warning messages during boot when the adapters with less power capacity are detected. By default, the ON option is enabled.
Warning and Errors	Enables or disables the action to be taken when a warning or error is encountered. By default, the Prompt on Warnings and Errors option is selected. Stop, prompt, and wait for user input when warnings or errors are detected. NOTE: Errors deemed critical to the operation of the computer hardware stop the functioning of the computer.
USB-C Warnings	
Enable Dock Warning Messages	Enables or disables the dock warning messages. By default, the ON option is enabled.
Extend BIOS POST Time	Sets the BIOS POST (Power-On Self-Test) load time. By default, the 0 seconds option is selected.

Table 39. System setup options—Virtualization menu

Virtualization	
DMA Protection	
Enable Pre-Boot DMA support.	Allows you to control the Pre-Boot DMA protection for both internal and external ports. This option does not directly enable DMA protection in the operating system. NOTE: This option is not available when the virtualization setting for IOMMU is disabled (VT-d/AMD Vi). By default, the ON option is enabled. For additional security, Dell Technologies recommends keeping the Enable Pre-Boot DMA Support option enabled. NOTE: This option is provided only for compatibility purposes, since some older hardware is not DMA capable.

Table 39. System setup options—Virtualization menu (continued)

Virtualization	
Enable OS Kernel DMA support	<p>Allows you to control the Kernel DMA protection for both internal and external ports. This option does not directly enable DMA protection in the operating system. For operating systems that support DMA protection, this setting indicates to the operating system that the BIOS supports the feature.</p> <p>NOTE: This option is not available when the virtualization setting for IOMMU is disabled (VT-d/AMD Vi).</p> <p>By default, the ON option is enabled.</p> <p>NOTE: This option is provided only for compatibility purposes, since some older hardware is not DMA capable.</p>
Internal Port DMA Compatibility Mode	<p>Allows you to control the OS's ability to notify if the internal ports are DMA capable.</p> <p>By default, the OFF option is enabled.</p>

Table 40. System setup options—Performance menu

Performance	
PCIe Resizable Base Address Register (BAR)	
Enable PCIe Resizable Base Address Register (BAR) support	<p>Enable or disable PCIe Resizable BAR in the processor.</p> <p>By default, the OFF option is disabled.</p>

Table 41. System setup options—System Logs menu

System Logs	
BIOS Event Log	
Clear Bios Event Log	<p>Allows you to select option to keep or clear BIOS events logs.</p> <p>By default, the Keep Log option is selected.</p>
Power Event Log	
Clear Power Event Log	<p>Allows you to select option to keep or clear Power events logs.</p> <p>By default, the Keep Log option is selected.</p>

Updating the BIOS

Updating the BIOS in Windows

CAUTION: If BitLocker is not suspended before updating the BIOS, the BitLocker key is not recognized the next time you reboot the computer. You will then be prompted to enter the recovery key to proceed, and the computer displays a prompt for the recovery key on each reboot. Failure to provide the recovery key can result in data loss or an operating system reinstall. For more information, refer [Updating the BIOS on Dell systems with BitLocker enabled](#).

CAUTION: Do not turn off the computer during the BIOS flash update process. The computer may not boot if you turn off your computer.

1. Go to [Dell Support Site](#).
2. Go to **Identify your product or ask support**. In the box, enter the product identifier, model, service request or describe what you are looking for, and then click **Search**.

NOTE: If you do not have the Service Tag, click **Detect This PC**. The site automatically detects your device, and you can then click **Explore Product Support** to go to the support page for your device. You can also use the product ID or manually browse for your computer model.

3. Click **Drivers & Downloads**.
 4. Select the operating system installed on your computer.
 5. In the **Category** drop-down list, select **BIOS**.
 6. Select the latest version of BIOS, and click **Download** to download the BIOS file for your computer.
 7. After the download is complete, navigate to the folder where the BIOS update file has been saved.
 8. Double-click the BIOS update file and follow the on-screen instructions.
- For more information, search [Dell Support Site](#).

Updating the BIOS in Linux and Ubuntu

To update the system BIOS on a computer that is installed with Linux or Ubuntu, see [How to Update the Dell BIOS in the Ubuntu or Linux Environment](#) at [Dell Support Site](#).

Updating the BIOS using the USB drive in Windows

CAUTION: If BitLocker is not suspended before updating the BIOS, the BitLocker key is not recognized the next time you reboot the computer. You will then be prompted to enter the recovery key to proceed, and the computer displays a prompt for the recovery key on each reboot. Failure to provide the recovery key can result in data loss or an operating system reinstall. For more information, refer [Updating the BIOS on Dell systems with BitLocker enabled](#).

CAUTION: Do not turn off the computer during the BIOS flash update process. The computer may not boot if you turn off your computer.

1. Go to [Dell Support Site](#).
 2. Go to **Identify your product or ask support**. In the box, enter the product identifier, model, service request or describe what you are looking for, and then click **Search**.
- NOTE:** If you do not have the Service Tag, click **Detect This PC**. The site automatically detects your device, and you can then click **Explore Product Support** to go to the support page for your device. You can also use the product ID or manually browse for your computer model.
3. Click **Drivers & Downloads**.
 4. Select the operating system installed on your computer.
 5. In the **Category** drop-down list, select **BIOS**.
 6. Select the latest version of BIOS, and click **Download** to download the BIOS file for your computer.
 7. Create a bootable USB drive. For more information, search [Dell Support Site](#).
 8. Copy the BIOS setup program file to the bootable USB drive.
 9. Connect the bootable USB drive to the computer that needs the BIOS update.
 10. Restart the computer and press **F12**.
 11. Select the USB drive from the **One Time Boot Menu**.
 12. Type the BIOS setup program filename and press **Enter**.
The **BIOS Update Utility** appears.
 13. Follow the on-screen instructions to complete the BIOS update.

Updating the BIOS from the One-Time boot menu

To update the BIOS from the One-Time boot menu, see [Updating the BIOS from the One Time Boot Menu](#) at [Dell Support Site](#).

Updating the BIOS

Updating the BIOS in Windows

CAUTION: If BitLocker is not suspended before updating the BIOS, the BitLocker key is not recognized the next time you reboot the computer. You will then be prompted to enter the recovery key to proceed, and the computer displays a prompt for the recovery key on each reboot. Failure to provide the recovery key can result in data loss or an operating system reinstall. For more information, see the Knowledge Base Resource [Updating the BIOS on Dell systems with BitLocker enabled](#).

CAUTION: Do not turn off the computer during the BIOS flash update process. The computer may not boot if you turn off your computer.

1. Go to [Dell Support Site](#).
2. Go to **Identify your product or ask support**. In the box, enter the product identifier, model, service request or describe what you are looking for, and then click **Search**.
 - NOTE:** If you do not have the Service Tag, click **Detect This PC**. The site automatically detects your device, and you can then click **Explore Product Support** to go to the support page for your device. You can also use the product ID or manually browse for your computer model.
3. Click **Drivers & Downloads**.
4. Select the operating system installed on your computer.
5. In the **Category** drop-down list, select **BIOS**.
6. Select the latest version of BIOS, and click **Download** to download the BIOS file for your computer.
7. After the download is complete, navigate to the folder where the BIOS update file has been saved.
8. Double-click the BIOS update file and follow the on-screen instructions.
For more information, search in the Knowledge Base Resource at [Dell Support Site](#).

Updating the BIOS using the USB drive in Windows

CAUTION: If BitLocker is not suspended before updating the BIOS, the BitLocker key is not recognized the next time you reboot the computer. You will then be prompted to enter the recovery key to proceed, and the computer displays a prompt for the recovery key on each reboot. Failure to provide the recovery key can result in data loss or an operating system reinstall. For more information, see the Knowledge Base Resource [Updating the BIOS on Dell systems with BitLocker enabled](#).

CAUTION: Do not turn off the computer during the BIOS flash update process. The computer may not boot if you turn off your computer.

1. Go to [Dell Support Site](#).
2. Go to **Identify your product or ask support**. In the box, enter the product identifier, model, service request or describe what you are looking for, and then click **Search**.
 - NOTE:** If you do not have the Service Tag, click **Detect This PC**. The site automatically detects your device, and you can then click **Explore Product Support** to go to the support page for your device. You can also use the product ID or manually browse for your computer model.
3. Click **Drivers & Downloads**.
4. Select the operating system installed on your computer.
5. In the **Category** drop-down list, select **BIOS**.
6. Select the latest version of BIOS, and click **Download** to download the BIOS file for your computer.
7. Create a bootable USB drive. For more information, search the Knowledge Base Resource at [Dell Support Site](#).
8. Copy the BIOS Setup program file to the bootable USB drive.
9. Connect the bootable USB drive to the computer that needs the BIOS update.
10. Restart the computer and press **F12**.

11. Select the USB drive from the **One Time Boot Menu**.
12. Type the BIOS Setup program filename and press **Enter**.
The **BIOS Update Utility** appears.
13. Follow the on-screen instructions to complete the BIOS update.

Updating the BIOS in Linux and Ubuntu

To update the system BIOS on a computer that is installed with Linux or Ubuntu, see [How to Update the Dell BIOS in the Ubuntu or Linux Environment](#) at [Dell Support Site](#).

Updating the BIOS from the One-Time boot menu

To update the BIOS from the One-Time boot menu, see Knowledge base article [000128928](#) at [Dell Support Site](#).

System and setup password

 **CAUTION:** The password features provide a basic level of security for the data on your computer.

 **CAUTION:** Ensure that your computer is locked when it is not in use. Anyone can access the data that is stored on your computer, when left unattended.

Table 42. System and setup password

Password type	Description
System password	Password that you must enter to boot to your operating system.
Setup password	Password that you must enter to access and change the BIOS settings of your computer.

You can create a system password and a setup password to secure your computer.

 **NOTE:** The System and setup password feature is disabled by default.

Assigning a System Setup password

You can assign a new System or Admin Password only when the status is set to **Not Set**. To enter BIOS System Setup, press F2 immediately after a power-on or reboot.

1. To enter the **System Setup**, press **F2** immediately after a power-on or reboot.
2. In the **System BIOS** or **System Setup** screen, select **Security** and press Enter.
The **Security** screen is displayed.
3. Select **System/Admin Password** and create a password in the **Enter the new password** field.
Use the following guidelines to create the system password:
 - Password can be up to 32 characters.
 - Password must contain at least one special character: "(! " # \$ % & ' * + , - . / : ; < = > ? @ [\] ^ _ ` { | })"
 - The password can contain numbers from 0 to 9.
 - The password can contain alphabets A to Z and a to z.
4. Type the system password that you entered earlier in the **Confirm new password** field and click **OK**.
5. Press Y to save the changes.
The computer restarts.

Deleting or changing an existing system password or setup password

Ensure that the **Password Status** is Unlocked in the System Setup before attempting to delete or change the existing system password and/or setup password. You cannot delete or change an existing system password or setup password if the **Password Status** is Locked. To enter the System Setup, press F2 immediately after a power-on or reboot.

1. To enter the **System Setup**, press **F2** immediately after a power-on or reboot.
2. In the **System BIOS** or **System Setup** screen, select **System Security** and press Enter. The **System Security** screen is displayed.
3. In the **System Security** screen, verify that the **Password Status** is Unlocked.
4. Select **System Password**. Update or delete the existing system password, and press Enter or Tab.
5. Select **Setup Password**. Update or delete the existing setup password, and press Enter or Tab.

 **NOTE:** If you change the system password and/or setup password, reenter the new password when prompted. If you delete the system password and/or setup password, confirm the deletion when prompted.

6. Press Esc. A message prompts you to save the changes.
7. Press Y to save the changes and exit from **System Setup**. The computer restarts.

Clearing CMOS settings

 **CAUTION:** Clearing CMOS settings resets the BIOS settings on your computer.

1. Remove the [side cover](#).
2. Remove the [coin-cell battery](#).
3. Wait for one minute.
4. Replace the [coin-cell battery](#).
5. Replace the [side cover](#).

Clearing system and setup passwords

To clear the system or setup passwords, contact Dell technical support as described at [Contact Support](#).

 **NOTE:** For information about how to reset Windows or application passwords, see the documentation accompanying Windows or your application.

Troubleshooting

Dell SupportAssist Pre-boot System Performance Check diagnostics

SupportAssist diagnostics (also known as system diagnostics) performs a complete check of your hardware. The Dell SupportAssist Pre-boot System Performance Check diagnostics is embedded within the BIOS and launched by the BIOS internally. The embedded system diagnostics provides options for particular devices or device groups allowing you to:

- Run tests automatically or in an interactive mode.
 - Repeat the tests.
 - Display or save test results.
 - Run thorough tests to add more options and obtain details about any failed devices.
 - View status messages that inform you when the tests are completed successfully.
 - View error messages that inform you of problems encountered during testing.
-  **NOTE:** Some tests for specific devices require user interaction. Always ensure that you are present at the computer when the diagnostic tests are performed.

For more information, see [How to Run Dell Preboot Diagnostics and Hardware Tests on Your Dell Computer](#).

Running the SupportAssist Pre-Boot System Performance Check

1. Turn on your computer.
2. As the computer boots, press the F12 key.
3. On the boot menu screen, select **Diagnostics**.
The diagnostic quick test begins.
 **NOTE:** For more information about running the SupportAssist Pre-Boot System Performance Check on a specific device, see [Dell Support Site](#).
4. If there are any issues, error codes are displayed.
Note the error code and validation number and contact Dell.

Power-Supply Unit Built-in Self-Test

Built-in Self-Test (BIST) helps determine if the power-supply unit is working. To run self-test diagnostics on the power-supply unit of a desktop or all-in-one computer, search in the Knowledge Base Resource at [Dell Support Site](#).

System-diagnostic lights

This section lists the system-diagnostic lights of your Dell Pro Micro QCM1255.

The following table shows different Service LED blinking patterns and associated problems. The diagnostic light codes consist of a two-digit number, and the digits are separated by a comma. The number stands for a blinking pattern; the first digit shows the number of blinks in amber color, and the second digit shows the number of blinks in white color. The Service LED blinks in the following manner:

- The Service LED blinks the number of times equal to the value of the first digit and turns off with a short pause.
- After that, the Service LED blinks the number of times equal to the value of the second digit.
- The Service LED turns off again with a longer pause.
- After the second pause, the blinking pattern will be repeated.

Table 43. Diagnostic light codes

Diagnostic light codes (Amber, White)	Problem description
1,1	TPM Detection Failure
1,2	Unrecoverable SPI Flash Failure
1,5	EC unable to program i-Fuse
1,6	Generic catch-all for ungraceful EC code flow errors
1,7	Non-RPMC Flash on Boot Guard fused system
1,8	Chipset "Catastrophic Error" signal has tripped
2,1	CPU configuration or CPU failure
2,2	System board: BIOS or Read-Only Memory (ROM) failure
2,3	No memory or Random-Access Memory (RAM) detected
2,4	Memory or Random-Access Memory (RAM) failure
2,5	Invalid memory installed
2,6	System board/Chipset Error
2,7	LCD failure SBIOS message
2,8	Display power-rail failure on the system board
3,1	CMOS battery failure
3,2	PCI of Video card/chip failure
3,3	Recovery image not found
3,4	Recovery image found but invalid
3,5	EC power-rail error
3,6	Flash corruption detected by SBIOS
3,7	Timeout waiting on ME to reply to HECI message
4,1	Memory DIMM power rail failure
4,2	CPU Power cable connection issue

Recovering the operating system

When your computer is unable to boot to the operating system even after repeated attempts, it automatically starts Dell SupportAssist OS Recovery.

Dell SupportAssist OS Recovery is a stand-alone tool that is preinstalled on Dell computers running the Windows operating system. It consists of tools to diagnose and troubleshoot issues that may occur before your computer boots to the operating system. It enables you to diagnose hardware issues, repair your computer, back up your files, and restore your computer to its factory state.

You can also download it from the Dell Support website to troubleshoot and fix your computer when it fails to boot into the primary operating system due to software or hardware failures.

For more information about the Dell SupportAssist OS Recovery, see *Dell SupportAssist OS Recovery User's Guide* at [Serviceability Tools at the Dell Support Site](#). Click **SupportAssist** and then click **SupportAssist OS Recovery**.

 **NOTE:** Windows 11 IoT Enterprise LTSC 2024 and Dell ThinOS 10 do not support Dell SupportAssist. For more information about recovering ThinOS 10, see [Recovery mode using R-Key](#).

Real-Time Clock—RTC reset

The Real-Time Clock (RTC) reset function allows you or the service technician to recover the recently launched model Dell Pro and Pro Max computers from **No POST/No Boot/No Power** situations. You can initiate the RTC reset on the computer from a power-off state only if it is connected to AC power. Press and hold the power button for 25 seconds. The system RTC reset occurs after you release the power button.

NOTE: If AC power is disconnected from the computer during the process or the power button is held longer than 40 seconds, the RTC reset process gets aborted.

The RTC reset will reset the BIOS to its default settings, disable AMD Pro, and reset the computer date and time. The following items are not affected by the RTC reset:

- Service Tag
- Asset Tag
- Ownership Tag
- Admin Password
- System Password
- Storage Password
- Key Databases
- System Logs

NOTE: The IT administrator's AMD Pro account and password on the computer will be unprovisioned. The computer needs to go through the setup and configuration process again to reconnect it to the AMD Pro server.

The below items may or may not be reset based on your custom BIOS setting selections:

- Boot List
- Enable Legacy Option ROMs
- Secure Boot Enable
- Allow BIOS Downgrade

Backup media and recovery options

It is recommended to create a recovery drive to troubleshoot and fix problems that may occur with Windows. Dell provides multiple options for recovering the Windows operating system on your Dell computer. For more information, see [Dell Windows Backup Media and Recovery Options](#).

Network power cycle

If your computer is unable to access the Internet due to network connectivity issues, reset your network devices by performing the following steps:

1. Turn off the computer.
2. Turn off the modem.

NOTE: Some Internet service providers (ISPs) provide a modem and router combo device.

3. Turn off the wireless router.
4. Wait for 30 seconds.
5. Turn on the wireless router.
6. Turn on the modem.
7. Turn on the computer.

Getting help and contacting Dell

Self-help resources

You can get information and help on Dell products and services using these self-help resources:

Table 44. Self-help resources

Self-help resources	Resource location
Information about Dell products and services	Dell Site
Tips	
Contact Support	In Windows search, type <code>Contact Support</code> , and press Enter.
Online help for operating system	Windows Support Site Linux Support Site
Access top solutions, diagnostics, drivers and downloads, and learn more about your computer through videos, manuals, and documents.	Your Dell computer is uniquely identified using a Service Tag or Express Service Code. To view relevant support resources for your Dell computer, enter the Service Tag or Express Service Code at Dell Support Site . For more information about how to find the Service Tag for your computer, see Locate the Service Tag on your computer .
Dell knowledge base articles	<ol style="list-style-type: none"> 1. Go to Dell Support Site. 2. On the menu bar at the top of the Support page, select Support > Support Library. 3. In the Search field on the Support Library page, type the keyword, topic, or model number, and then click or tap the search icon to view the related articles.

Contacting Dell

To contact Dell for sales, technical support, or customer service issues, see [Contact Support at Dell Support Site](#).

 **NOTE:** Availability of the services may vary depending on the country or region, and product.

 **NOTE:** If you do not have an active Internet connection, you can find contact information in your purchase invoice, packing slip, bill, or Dell product catalog.

Revision history

Tracks all updates that are made to the document. It typically includes the date of change, version number, and a brief description of the modification. This log helps maintain transparency, accountability, and a clear timeline of progress.

Table 45. Revision history

Revision	Date	Description
A03	April 2026	Added Quebec requirement information.
A01	July 2025	Updated NOTES in SSD replacement topics to clarify thermal pad requirements.
A00	March 2025	Original publish date.