

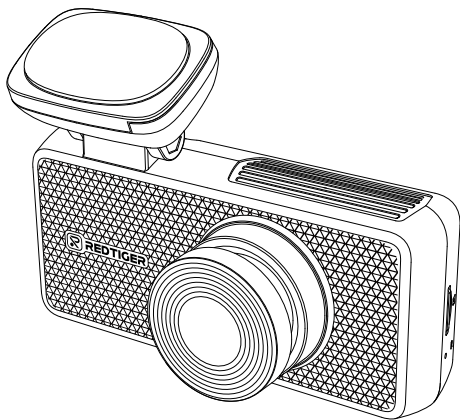

V1.2

**REDTIGER**

Truly Peace of Mind™



# **F17 Plus** User Manual

[redtigercam.com](http://redtigercam.com)

The information in this manual is subject to change without notice.



## General Overview

Notice . . . . .	I
Package Contents . . . . .	II
Appearance . . . . .	III

## After-Sales

Customer Service Center . . . . .	97
-----------------------------------	----

## Language

English . . . . .	<b>1 - 19</b>
Deutsch . . . . .	<b>20 - 38</b>
Français . . . . .	<b>40 - 57</b>
Italiano . . . . .	<b>58 - 77</b>
Español . . . . .	<b>78 - 96</b>

## Notice

- Please read this manual carefully before operation and keep it for future reference. It will be helpful should you encounter any operational problem.
- Improper installation will void the manufacturer's warranty. The installation instructions do not apply to all types of vehicles and are written as guidelines to assist in installing the system.
- Consult an experienced technician if you are not comfortable installing the product.
- Please make sure to read and understand local laws and regulations regarding cameras and their use in a vehicle. Laws vary by state.
- Do not obscure the view of the road ahead or impede the deployment of any airbags in the event of an accident.
- When not in use, please disconnect the car adapter from both the 12/24V DC outlet in your vehicle and the device itself.
- Only clean the device with a soft dry cloth, for tough dirt, apply some neutral detergent diluted in 5 to 6 parts water on a soft cloth.
- Note that alcohol, thinner, benzene, etc could cause damage to the paint or coatings.
- Avoid making contact with the lens as this may cause damage.
- The video recordings made by this Digital Video Recorder are intended for personal use only.
- While driving, do not adjust the controls of your device as this is a distraction to driving.

## Package Contents

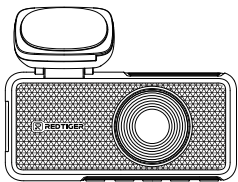

• F17 Plus 2.7K Dash Cam

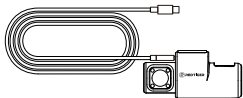

• 1080P\*2 Rear Camera

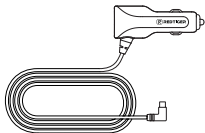

• Power Supply Cable with Car Charger



• Electrostatic Sticker \*2



• Adhesive



• User Manual

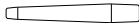

• Tool



• Cable Clips\*5

## Appearance

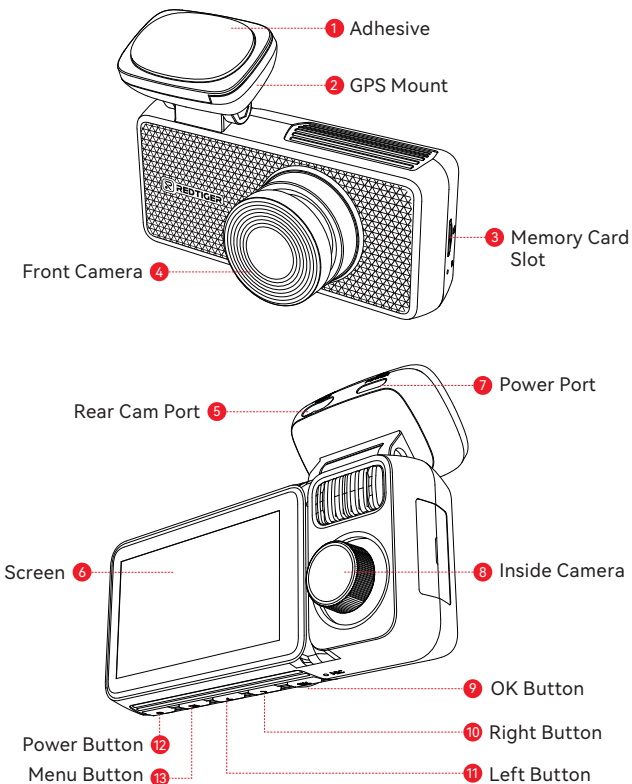

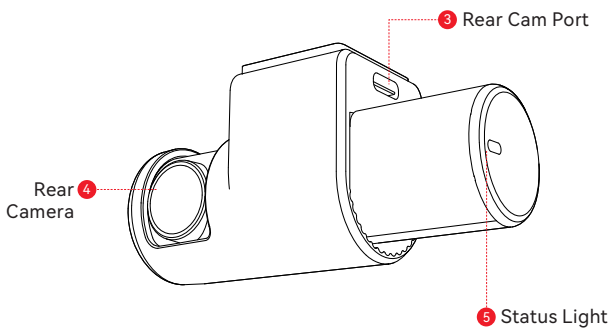
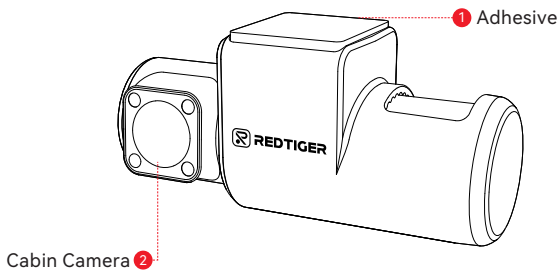

Product Specifications . . . . .	<b>2</b>
Buttons and Functions . . . . .	<b>3</b>
Voice Control Function . . . . .	<b>6</b>
User Interface Overview . . . . .	<b>7</b>
Function Overview . . . . .	<b>10</b>
OTA(Over the air) Update . . . . .	<b>13</b>
How to Play Video on Computer . . . . .	<b>13</b>
Installation . . . . .	<b>15</b>
Trouble Shooting . . . . .	<b>19</b>

## Product Specifications

Item Name	F17 Plus Dash Cam	Video Format	MP4
Screen Size	3" IPS	Photo Format	JPG
Recording Resolution	Front 2.7K+Front Cabin 1080P+Rear Cabin 1080P+Rear 1080P		
Lens	F1.8	Input	DC 12V/24V
Operating Temperature	-4°F~158°F	Output	DC 5V-2.5A
Micro SD card	Max Support 512GB	Warranty Period	18 Months

### Note:

In the event of a problem during use, we will offer 18 months free warranty from the date of purchase, in addition to lifetime technical support.

\* The specific warranty period is subject to local laws.

### Extended Warranty Service:

After registering information on [redtigercam.com](http://redtigercam.com), you may extend the warranty for an additional 6 months free of charge.

URL: <https://www.redtigercam.com/pages/warranty-form>

## Buttons and Functions



### Power Button

Recording Mode:

- Short press-to Take a snapshot
- Long press-to Turn off the Camera

Setup Mode:

- Short press-to Return to the previous screen

Playback Mode:

- Short press-to Return to the previous screen



### Menu Button

Recording Mode:

- Short press to Enter main menu
- Long press-to Turn on/off WiFi

Setup Mode:

- Short press-to Enter screen saver display

Playback Mode:

- Short press-to Delete/Lock/Unlock the specific file



### Left Button

Recording Mode:

- Short press-to Lock/Unlock the recording file

Setup Mode:

- Short press-to Select the previous function

Playback Mode:

- Short press-to Fast rewind while video being played



## **Right Button**

Recording Mode:

- Short press-to Enter playback mode

Setup Mode:

- Short press-to Select the next function

Playback Mode:

- Short press-to Select the next file
- Short press-to Fast forward while video is being played

A white 'OK' text inside a light gray rounded square.

## **OK Button**

Recording Mode:

- Short press-to Switch screen

Setup Mode:

- Short press-to Enter/Confirm specific settings

Playback Mode:

- Short press-to Select and play the specific file

## • Video Mode

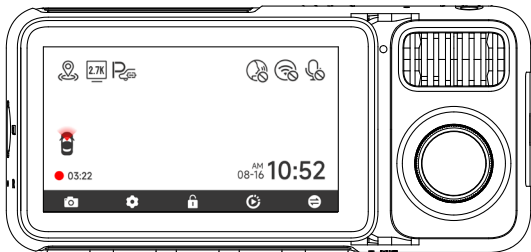

You can manually click the icon  at the top of the screen to choose whether to turn on the Voice control.

You can manually click the icon  at the top of the screen to choose whether to turn on Wi-Fi.

You can manually click the icon  at the top of the screen to choose whether to record audio during video recording.

## Voice Control Function

Fast control through simple voice commands

If the icon is white , it means the function can be used normally.

You have two ways to enable this feature.

- 1 Tap on the icon to turn the feature on or off.
- 2 Enter the setting mode-voice control-on/off.

lock the video	
take picture	
turn on Audio	turn off Audio
turn on screen	turn off screen
turn on wifi	turn off wifi
turn on recording	turn off recording
show front camera	show rear camera







### Note:

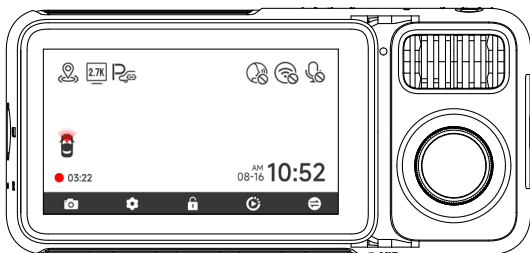





You can see the specific commands in setting-voice control.

# User Interface Overview

## • Recording Mode



Icon	Description
	GPS status
	Recording resolution
	Whether to connect the hardwire kit and set up parking monitoring
	Voice control
	Wi-Fi status
	Voice recording status

Icon	Description
	Which camera is being displayed
● 03:22	Recording status and recording time
● 03:22	Emergency recording is on
08-16 10:52 AM	Date and time of the camera
	Photograph
	Short press to enter settings. Long press for 3 seconds to turn on or off WiFi
	Emergency recording. Short press to lock the video
	Playback
	Switching from front, inside and rear cameras

## • Playback Mode

- 1 Press the **M** button to access the playback folder.
- 2 Press the Left or Right button to select the folder you want to play, then press the **M** button to enter.

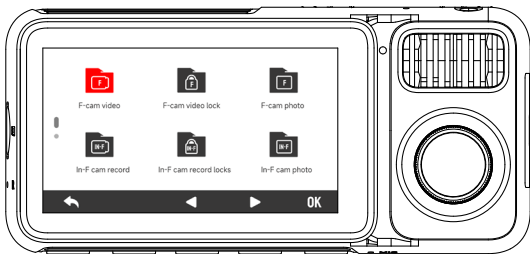

- 3 Press the **OK** button to watch the recorded video.
- 4 Long press the **OK** button for 3 seconds to edit your recorded videos.

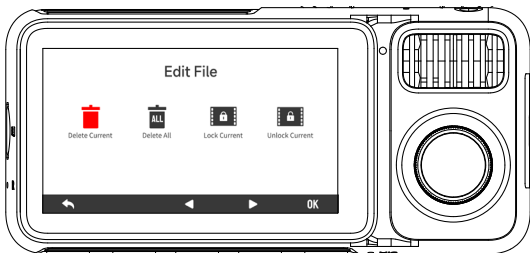























### Note:











All of the above functions can be done via the touch screen.

## Function Overview

Short press M button to enter settings menu, where you can adjust various functions.

Icon	Function	Option/Description
	Resolution	2.7K+1080P+1080P+1080P/ 2.5K+1080P+1080P+1080P/ 1080P+1080P+1080P+1080P
	Audio	ON/OFF
	Recording duration	1/3/5mins
	G-sensor	Off/Low/Medium/High
	Fatigue reminder	A Reminder Will be Made During 1h/2h/3h/4h/OFF
	Wi-Fi	ON/OFF
	Volume	OFF/Low/Medium/High
	Click Tone	ON/OFF
	Startup Sound	ON/OFF
	Screen Saver	OFF/10 Seconds/30 Seconds/2 Minutes
	Voice control	ON/OFF/Voice Command

Icon	Function	Option/Description
	In-F Recording	ON/OFF
	In-R Recording	ON/OFF
	Mirror Flip	Horizontal Flip Your Rear View *Need to connect rear camera
	Rear Cam Flip	Vertical Flip Your Rear View *Need to connect rear camera
	Parking Monitor	Please connect the ACC hardwire kit
	GPS	Display GPS signal strength
	Date Stamp	ON/OFF
	Speed Stamp	ON/OFF
	GPS Stamp	ON/OFF
	Speed Units	KM/H / MPH
	Language	Choose Your Preferred Language
	Clock Settings	Update With GPS
	Time Style	12h/24h

Icon	Function	Option/Description
	Time Zone	Choose Your Time Zone
	DST	Daylight Saving Time ON/OFF
	Flicker	60Hz/50Hz
	Format Reminder	Reminder to Clear Data
	Format SD Card	Format SD card. All data will be deleted
	Card Speed	Card Speed Detection
	Reset Setup	Reset All Settings
	APP	A QR Code for app
	Product Information	Software Version
	Help Center	Scan the QR code to contact us

## Note:

- In order to a Clean, Smooth, Comfortable using experience, we suggest you format your Memory Card once a month.
- When you turn off Click Tone, the startup and shutdown sounds will also be turned off.

## OTA(Over the air) Update

**Note:** Please update the update the APP to the latest version to use this function.

1. Disconnect the mobile phone and dash cam Wi-Fi.  
Connect the phone to lan for 5 seconds, then disconnect.  
Finally, connect the dash cam Wi-Fi.
2. Once Wi-Fi connection is successful, open the Redtiger APP to start using it. If new software is detected, the APP page will indicate the availability of an update.
3. To upgrade, click on "Upgrade Now". The Redtiger APP will prompt you to download the upgrade package.  
Please note that the actual firmware should prevail over the upgrade package.
4. Connect the dash cam to send the upgrade package.  
Do not power off the dash cam during the upgrade process.  
Once the upgrade is completed, the APP will display the upgrade success message, and the dash cam will automatically restart.

## How to Play Video on Computer

We recommend using REDTIGER Player as the right video Player to watch/play Videos. It can also view Google Maps.

You can Download it for free on Mac or Windows from the following link: <https://www.redtigerscam.com/pages/gps-player>

You can choose different playback modes in Settings>video playback mode. And you can set playback speed, language, map and other functions.



- 1 Video play window (Front)
- 2 Map and track display
- 3 Play control panel
- 4 Speed and driving state indication
- 5 Play list

### Note:

When you find the desired video file, hold down the left mouse button and drag and drop it onto the video player to play it.

## Installation

### **⚠ WARNING**

Please make sure to connect all cameras and wires before power on the cam screen, otherwise, the camera cannot work properly. Please follow the instructions below for the first-time installation of the redtiger dash cam.

- **Insert Memory Card**

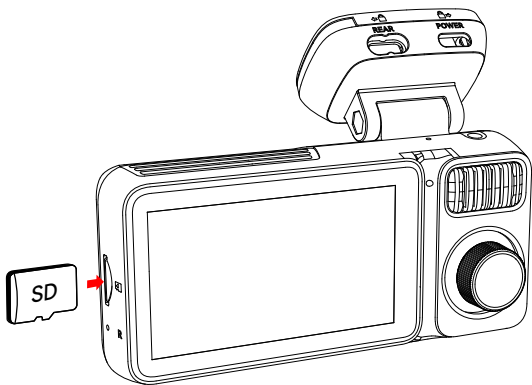

## • Front Camera Installation

Peel off the electrostatic sticker on the cellophane and transfer it to where you want to stick it. Attach the front camera to the electrostatic sticker and press to make it firmer.

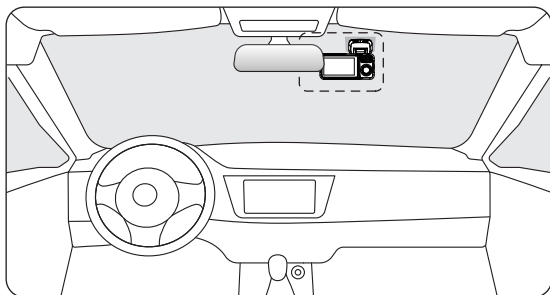
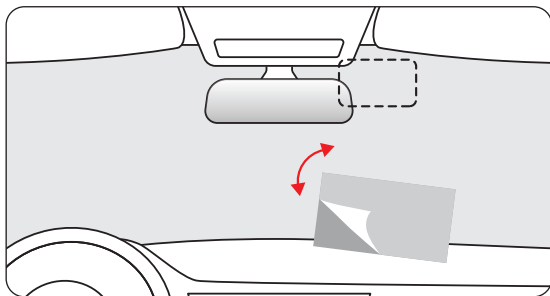

## • Wire Layout In The Vehicle

- 1 The car charger is connected to the cigar socket.
- 2 Connect the other end of the car charger to the dash cam.
- 3 Use the crowbar to run the power cable along the front windshield and the roof, and hide the cable down the A-pillar, so as not to block the driver's sight and cause danger.

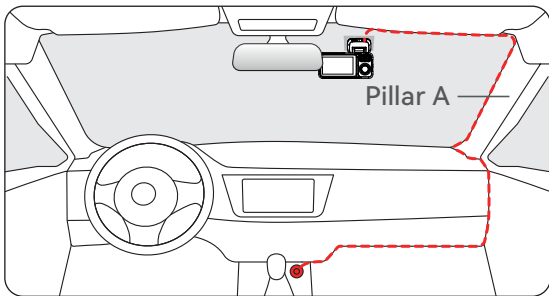

## • Rear camera installation

- 1 Make sure the Cabin Cam faces inside, with the camera logo facing up.
- 2 Power on the dash cam and check the rear camera view to confirm the best position.
- 3 Apply the static sticker, mount the camera, and adjust the angle for optimal view.

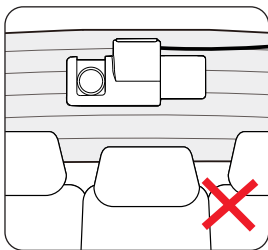
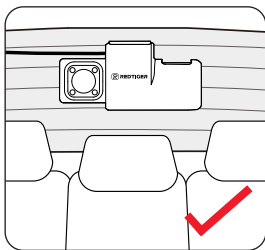
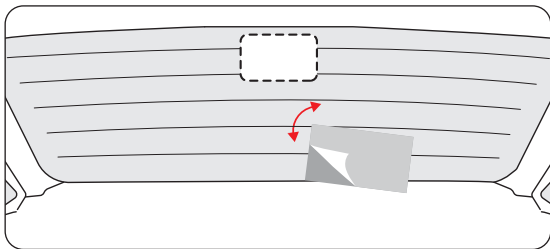

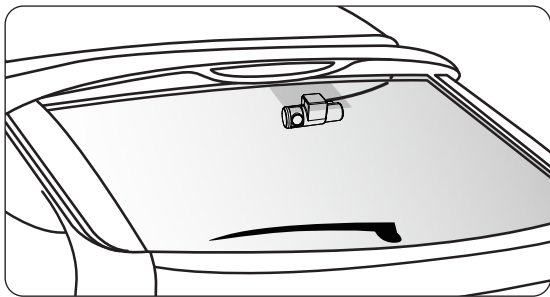

## Trouble Shooting

### • Why is there no GPS signal?

1. Clean and reconnect the probe on the main unit and bracket. Check for any interference in your car, like metal film on the windshield, radio antenna, or radar detector.
2. Move your car to an open area.
3. If the GPS icon is  , it means the GPS signal is good.

If the GPS icon is  , it means there is no GPS signal.

### • Why does my dash cam prompt card error or please format Memory Card every once in a while?

Please follow the steps below to check:

1. Please go to Settings > Format Reminder to check whether the regular format reminder is enabled.
2. Format the Memory Card.
3. Restore factory settings and restart the dash cam.
4. Update the firmware.

- **Dash cam repeated restart/no boot?**

1. Make sure you are using the original car charger.
2. Unplug the Memory Card and car charger in turn, and reinstall them. Check whether the short circuit is caused by accessories.
3. Reset the machine through the small hole at the bottom of the driving recorder.
4. If none of the above can solve the problem, please try to power on the USB cable to confirm whether the host can be used normally.
5. Please go to the official website to update the firmware.
6. If it is not resolved, please contact your dedicated customer service for a replacement.

- **Why can't I connect to Wi-Fi?**

1. Check the working distance of Wi-Fi, about 15ft.
2. Check the SSID and password of the Wi-Fi, or whether there are other devices connected to the Wi-Fi.
3. Turn off mobile data, security software, and VPN on your phone.
4. If the issue persists, please contact customer support for assistance.

- **Why is the time setting incorrect?**

The dash cam features built-in GPS. It automatically adjusts time based on your location and time zone, eliminating the need for manual time changes. And you can adjust the time through Settings > Time Zone/DST.

Produktspezifikationen . . . . .	<b>22</b>
Tasten und Funktionen . . . . .	<b>23</b>
Sprachsteuerungsfunktion . . . . .	<b>26</b>
Übersicht über die Benutzeroberfläche . . . . .	<b>27</b>
Funktionsübersicht. . . . .	<b>30</b>
OTA (Over-the-air) Update . . . . .	<b>33</b>
Wie man Video Auf dem Computer Abspielt . . . . .	<b>33</b>
Installation . . . . .	<b>35</b>
Fehlerbehebung . . . . .	<b>38</b>

## Produktspezifikationen

Artikelbezeichnung	F17 Plus Dashcam	Videoformat	MP4
Bildschirmgröße	3"-IPS-Bildschirm	Fotoformat	JPG
Aufnahme Auflösung	Vorne 2.7K+Vorne Innen 1080P+ Hinten Innen 1080P+Hinten 1080P		
Linse	F1.8	Eingang	DC 12V/24V
Betriebstemperatur	-4°F~158°F	Ausgang	DC 5V-2.5A
Speicherkarte	Maximal unterstützt 512GB	Garantie Zeitraum	18 Monate

### Hinweis:

Im Falle eines Problems während der Nutzung bieten wir ab Kaufdatum eine 18-monatige kostenlose Garantie sowie lebenslangen technischen Support.

### Erweiterter Garantieservice:

Nach der Registrierung Ihrer Informationen auf [redtigercam.com](https://www.redtigercam.com) können Sie die Garantie kostenlos um weitere 6 Monate verlängern.

URL: <https://www.redtigercam.com/pages/warranty-form>

## Tasten und Funktionen



### Power-Taste

Aufnahmemodus:

- Kurzes drücken – um einen Schnappschuss zu machen
- Lange drücken, um die Kamera auszuschalten

Setup-Modus:

- Kurz drücken, um zum vorherigen Bildschirm zurückzukehren

Wiedergabemodus:

- Kurz drücken, um zum vorherigen Bildschirm zurückzukehren



### Menü-Taste

Aufnahmemodus:

- Kurz drücken, um das Hauptmenü aufzurufen
- Langes drücken – um WiFi ein-/auszuschalten

Setup-Modus:

- Kurzes drücken – um den Bildschirmschoner anzuzeigen

Wiedergabemodus:

- Kurzes drücken – um die spezifische Datei zu löschen/sperren/entsperren



### **Linke Taste**

Aufnahmemodus:

- Kurzes drücken – um die Aufnahme­datei zu sperren/entsperren

Setup-Modus:

- Kurz drücken, um die vorherige Funktion auszuwählen

Wiedergabemodus:

- Kurz drücken, um schnell zurückzuspulen (während das Video abgespielt wird)



### **Rechte Taste**

Aufnahmemodus:

- Kurzes drücken – um in den Wiedergabemodus zu wechseln OK-Taste

Setup-Modus:

- Kurz drücken, um die nächste Funktion auszuwählen

Wiedergabemodus:

- Kurz drücken, um die nächste Datei auszuwählen
- Kurz drücken, um schnell vorzuspulen (während das Video abgespielt wird)

**OK**

### **OK-Taste**

Aufnahmemodus:

- Kurzes Drücken – Um den Bildschirm zu wechseln

Einstellungsmodus:

- Kurzes Drücken – Um spezifische Einstellungen einzugeben/bestätigen

Wiedergabemodus:

- Kurzes Drücken – Um die spezifische Datei auszuwählen und abzuspielen

## • Videomodus

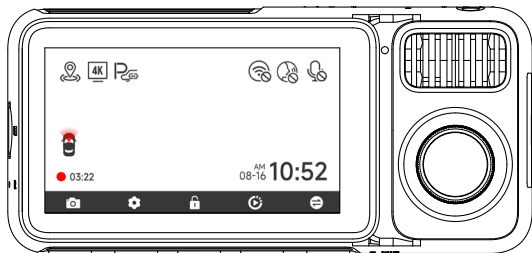

Sie können manuell auf das Symbol  oben auf dem Bildschirm klicken, um auszuwählen, ob Audio während der Videoaufnahme aufgenommen werden soll.

Sie können manuell auf das Symbol  oben auf dem Bildschirm klicken, um auszuwählen, ob WLAN aktiviert werden soll.

Sie können manuell auf das Symbol  oben auf dem Bildschirm klicken, um auszuwählen, ob Sie die Sprachsteuerung aktivieren möchten.

## Sprachsteuerungsfunktion

Schnelle Steuerung durch einfache Sprachbefehle.

Wenn das Symbol  weiß ist, bedeutet dies, dass die Funktion normal verwendet werden kann.

Es gibt zwei Möglichkeiten, diese Funktion zu aktivieren.

- 1 Tippen Sie auf das Symbol, um die Funktion zu aktivieren oder zu deaktivieren.
- 2 Gehen Sie zu Einstellungen – Sprachsteuerung – Ein/Aus.

lock the video	
take picture	
turn on Audio	turn off Audio
turn on screen	turn off screen
turn on wifi	turn off wifi
turn on recording	turn off recording
show front camera	show rear camera







### Hinweis:

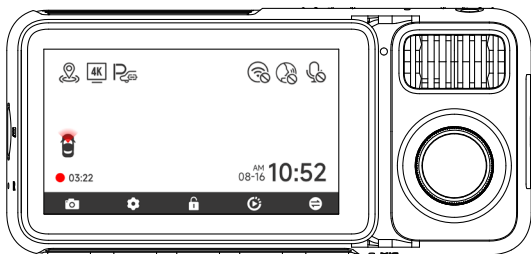





1. Sie können spezifische Befehle in den Einstellungen für Sprachsteuerung sehen.
2. Die Sprachsteuerungsfunktion unterstützt nur Englisch.

# Übersicht über die Benutzeroberfläche

## • Aufnahmemodus



Symbol	Beschreibung
	GPS-Status anzeigen
	Aufnahmeauflösung anzeigen
	Ob das fest verdrahtete Kit angeschlossen und Parküberwachung eingerichtet werden soll
	WiFi-Status
	Sprachsteuerung
	Sprachaufnahmestatus

Symbol	Beschreibung
	Welche Kamera wird angezeigt
● 03:22	Aufzeichnungsstatus und Aufzeichnungszeit
● 03:22	Notaufnahme ist aktiv
08-16 10:52 AM	Datum und Uhrzeit der Kamera
	Fotografieren
	Das Menü aufrufen
	Kurzes Drücken, um die Einstellungen zu öffnen. Langes Drücken für 3 Sekunden, um WiFi ein- oder auszuschalten
	Wiedergabe
	Wechsel zwischen Front-, Innen- und Rückkameras

## • Wiedergabemodus

- 1 Drücken Sie die M-Taste, um auf den Wiedergabeordner zuzugreifen.
- 2 Drücken Sie die linke oder rechte Taste, um den Ordner auszuwählen, den Sie abspielen möchten, und drücken Sie dann die M-Taste, um einzutreten.

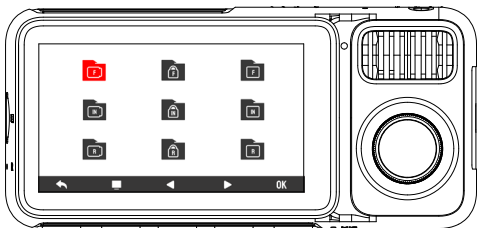

- 3 Drücken Sie die OK-Taste, um das aufgezeichnete Video anzusehen.
- 4 Halten Sie die OK-Taste 3 Sekunden lang gedrückt, um Ihre aufgezeichneten Videos zu bearbeiten.

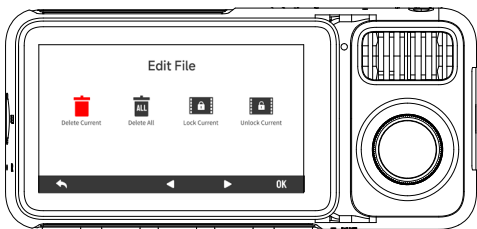























### **Hinweis:**











Alle oben genannten Funktionen können über den Touchscreen ausgeführt werden.

## Funktionsübersicht

Drücken Sie die M-Taste, um ins Einstellungsmenü zu gelangen und dort verschiedene Funktionen anzupassen.

Symbol	Funktion	Option/Beschreibung
	Auflösung	2.7K+1080P+1080P+1080P/ 2.5K+1080P+1080P+1080P/ 1080P+1080P+1080P+1080P
	Audio	EIN/AUS
	Aufnahmedauer	1/3/5 Minuten
	G-Sensor	Aus / Niedrig / Mittel / Hoch
	Müdigkeitswarnung	1h / 2h / 3h / 4h / AUS
	Wi-Fi	EIN/AUS
	Klick-Ton	EIN/AUS
	Startton	AUS/AN
	Bildschirmschoner	AUS/ 10 Sekunden/ 30 Sekunden/ 2 Minuten
	Sprachsteuerung	EIN/AUS / Sprachbefehl

Symbol	Funktion	Option/Beschreibung
	In-F Aufnahme	EIN/AUS
	In-R Aufnahme	EIN/AUS
	Spiegelumkehr	Horizontale Umkehr Ihrer Rückansicht *Rückkamera muss angeschlossen sein
	Rückkamera- Umkehr	Vertikale Umkehr Ihrer Rückansicht *Rückkamera muss angeschlossen sein
	Parküberwachung	Bitte ACC-Hardwire-Kit anschließen
	GPS	GPS-Signalstärke anzeigen
	Datumsstempel	EIN/AUS
	Geschwindigkeits- Stempel	EIN/AUS
	GPS-Stempel	EIN/AUS
	Geschwindigkeits- Einheiten	KM/H / MPH
	Sprache	Wählen Sie Ihre bevorzugte Sprache
	Uhreneinstellungen	Mit GPS aktualisieren
	Zeitformat	12h/24h

Symbol	Funktion	Option/Beschreibung
	Zeitzone	Wählen Sie Ihre Zeitzone
	Sommerzeit (DST)	Sommerzeit EIN/AUS
	Flimmern	60Hz/50Hz
	Format-Erinnerung	Datenlöschungserinnerung
	SD-Karte formatieren	SD-Karte formatieren. Alle Daten werden gelöscht
	Kartengeschwindigkeit	Kartengeschwindigkeitsprüfung
	Einstellungen zurücksetzen	Alle Einstellungen zurücksetzen
	APP	QR-Code für die App
	Produktinformationen	Softwareversion
	Hilfe-Center	Scannen Sie den QR-Code, um uns zu kontaktieren

## Hinweis :

- Um ein reibungsloses Benutzererlebnis zu gewährleisten, wird empfohlen, dass Sie Ihre Speicherkarte einmal im Monat formatieren.
- Wenn Sie die Einstellung Klick-Ton auf AUS ändern, werden auch die Töne beim Einschalten und Ausschalten ausgeschaltet.

## OTA (Over-the-air) Update

**Hinweis:** Bitte aktualisieren Sie die APP auf die neueste Version, um diese Funktion nutzen zu können.

1. Trennen Sie das Mobiltelefon und das Dashcam-Wi-Fi. Verbinden Sie das Telefon für 5 Sekunden mit dem WLAN und trennen Sie es dann. Schließlich verbinden Sie das Dashcam-Wi-Fi.
2. Sobald die Wi-Fi-Verbindung erfolgreich ist, öffnen Sie die Redtiger Cam APP, um sie zu verwenden. Wenn neue Software erkannt wird, zeigt die App-Seite die Verfügbarkeit eines Updates an.
3. Um ein Upgrade durchzuführen, klicken Sie auf "Jetzt aktualisieren". Die Redtiger APP wird Sie auffordern, das Upgrade-Paket herunterzuladen. Bitte beachten Sie, dass die tatsächliche Firmware gegenüber dem Upgrade-Paket Vorrang haben sollte.
4. Verbinden Sie die Dashcam, um das Upgrade-Paket zu senden. Schalten Sie die Dashcam während des Upgrade-Vorgangs nicht aus. Sobald das Upgrade abgeschlossen ist, zeigt die APP die Nachricht über den erfolgreichen Abschluss des Upgrades an und die Dashcam wird automatisch neu gestartet.

## Wie man Video auf dem Computer Abspielt

Wir empfehlen die Verwendung des REDTIGER Players als den richtigen Videoplayer zum Ansehen/Abspielen von Videos. Er kann auch Google Maps anzeigen.

Sie können ihn kostenlos auf Mac oder Windows über den folgenden Link herunterladen: <https://www.redtigerscam.com/pages/gps-player>

Sie können im Menü Einstellungen > Videowiedergabemodus verschiedene Wiedergabemodi auswählen. Außerdem können Sie Wiedergabegeschwindigkeit, Sprache, Karte und andere Funktionen einstellen.



- 1 Fenster zur Videowiedergabe (Vorderseite)
- 2 Video-Wiedergabefenster (Rückseite)
- 3 Karten- und Spuranzeige
- 4 Wiedergabe-Bedienfeld
- 5 Geschwindigkeits- und Fahrzustandsanzeige
- 6 Wiedergabeliste

### Hinweis:

Wenn Sie die gewünschte Videodatei gefunden haben, halten Sie die linke Maustaste gedrückt und ziehen Sie sie auf den Videoplayer, um sie abzuspielen.

## Installation

### **⚠️ WARNUNG**

Bitte stellen Sie sicher, dass alle Kameras und Kabel angeschlossen sind, bevor Sie den Kamerabildschirm einschalten, andernfalls wird die Kamera nicht richtig funktionieren. Bitte befolgen Sie die nachstehenden Anweisungen für die Erstinstallation der Redtiger Dashcam.

### • **Speicherkarte Einlegen**

Legen Sie die Speicherkarte in die Dashcam ein und achten Sie dabei auf die richtige Ausrichtung, sodass die Goldkontakte zum Bildschirm der Dashcam zeigen. Drücken Sie die Speicherkarte, bis sie im Steckplatz einrastet.

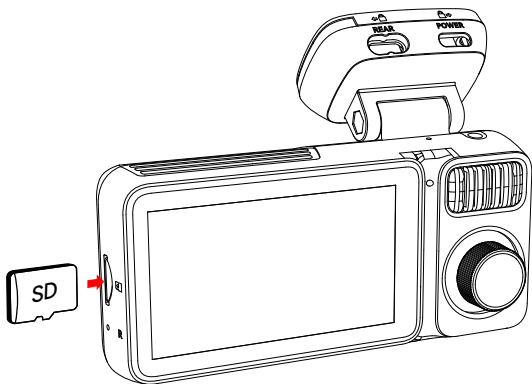

## • Installation der Frontkamera

Ziehen Sie den elektrostatischen Aufkleber von der Zellophanfolie ab und übertragen Sie ihn an die Stelle, an der Sie ihn anbringen möchten. Befestigen Sie die Frontkamera am elektrostatischen Aufkleber und drücken Sie, um sie fester zu machen.

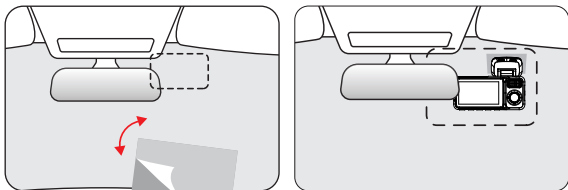

## • Kabelführung im Fahrzeug

- 1 Das Autoladegerät wird an die Zigarettensteckdose angeschlossen.
- 2 Schließen Sie das andere Ende des Autoladegeräts an die Dashcam an.
- 3 Führen Sie das Stromkabel mit dem Brecheisen an der vorderen Windschutzscheibe und am Dach entlang und verstecken Sie das Kabel an der A-Säule, um die Sicht des Fahrers nicht zu behindern und eine Gefahr darzustellen.

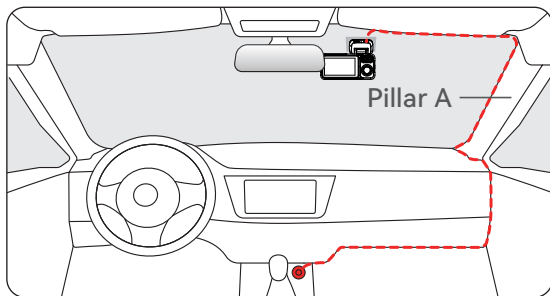

## • Installation der Rückkamera

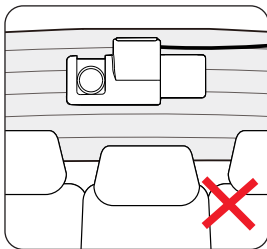
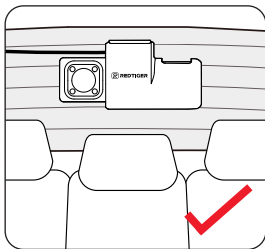
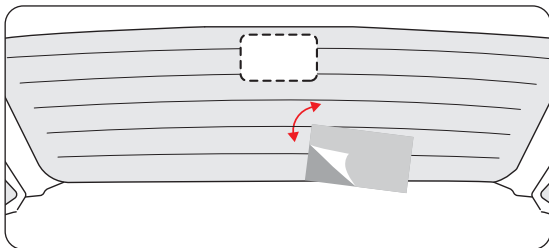

- 1 Stellen Sie sicher, dass die Kabinenkamera nach innen zeigt und das Kamera-Logo nach oben zeigt.
- 2 Schalten Sie die Dashcam ein und überprüfen Sie die Ansicht der Rückfahrkamera, um die beste Position zu finden.
- 3 Bringen Sie den statischen Aufkleber an, montieren Sie die Kamera und stellen Sie den Winkel für eine optimale Sicht ein.

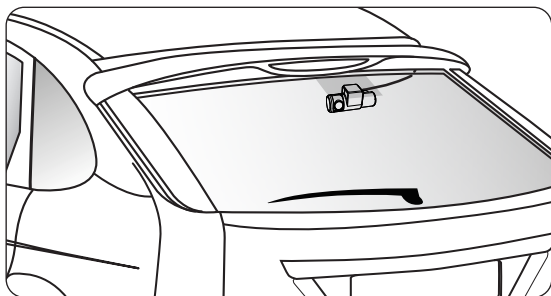



## Fehlerbehebung

### • Warum ist kein GPS-Signal vorhanden?

1. Reinigen und verbinden Sie die Sonde am Hauptgerät und der Halterung erneut. Überprüfen Sie auf Störungen in Ihrem Auto, wie z.B. Metallfolie auf der Windschutzscheibe, Radioantenne oder Radarwarner.
2. Bewegen Sie Ihr Auto in ein offenes Gebiet.
3. Wenn das GPS-Symbol  angezeigt wird, bedeutet das, dass das GPS-Signal gut ist. Wenn das GPS-Symbol  angezeigt wird, bedeutet das, dass kein GPS-Signal vorhanden ist.

### • Warum zeigt meine Dashcam immer wieder Kartenfehler an oder fordert auf, die Speicherkarte zu formatieren?

Bitte folgen Sie den nachstehenden Schritten zur Überprüfung:

1. Bitte gehen Sie zu Einstellungen > Erinnerung zum Formatieren, um zu prüfen, ob die reguläre Erinnerung zum Formatieren aktiviert ist.
2. Formatieren Sie die Speicherkarte.
3. Stellen Sie die Werkseinstellungen wieder her und starten Sie die Dashcam erneut.

4. Aktualisieren Sie die Firmware.

• **Dashcam startet wiederholt neu/nicht?**

1. Stellen Sie sicher, dass Sie das originale Autoladegerät verwenden.
2. Entfernen Sie die Speicherkarte und das Autoladegerät nacheinander und installieren Sie sie erneut. Überprüfen Sie, ob ein Kurzschluss durch Zubehör verursacht wird.
3. Setzen Sie das Gerät über das kleine Loch am Boden des Fahrtenrekorders zurück.
4. Wenn keine der oben genannten Lösungen das Problem beheben kann, versuchen Sie, das USB-Kabel einzuschalten, um zu überprüfen, ob das Hauptgerät normal verwendet werden kann.
5. Bitte besuchen Sie die offizielle Website, um die Firmware zu aktualisieren.
6. Wenn das Problem weiterhin besteht, wenden Sie sich bitte an unseren engagierten Kundendienst, um einen Ersatz zu erhalten.

• **Warum kann ich keine WLAN-Verbindung herstellen?**

1. Überprüfen Sie den Arbeitsabstand von Wi-Fi, etwa 15 Fuß.
2. Überprüfen Sie die SSID und das Passwort des Wi-Fi oder ob andere Geräte mit dem Wi-Fi verbunden sind.
3. Schalten Sie mobile Daten, Sicherheitssoftware und VPN auf Ihrem Telefon aus.
4. Wenn das Problem weiterhin besteht, wenden Sie sich bitte an den Kundendienst, um Hilfe zu erhalten.

• **Warum ist die Zeiteinstellung falsch?**

Die Dashcam verfügt über integriertes GPS. Sie passt die Zeit automatisch an Ihren Standort und Ihre Zeitzone an, sodass keine manuellen Zeitänderungen erforderlich sind. Und Sie können die Zeit über Einstellungen > Zeitzone/Sommerzeit anpassen.

# Table des Matières

FR

Product Specifications . . . . .	41
Boutons et Fonctions . . . . .	42
Fonction de Contrôle Vocal . . . . .	45
Aperçu de l'interface d'utilisateur . . . . .	46
Aperçu des Fonctionnalités . . . . .	49
Mise à jour OTA (Over-the-air) . . . . .	52
Comment Regarder une Vidéo Sur un Ordinateur . . . . .	52
Installation . . . . .	54
Dépannage . . . . .	57

## Product Specifications

Item Name	Caméra de tableau de bord F17 Plus	Format vidéo	MP4
Taille de l'écran	3" IPS	Format de la photo	JPG
Résolution d'enregistrement	Avant 2.7K + Intérieur avant 1080P + Intérieur arrière 1080P + Arrière 1080P		
Objectif	F1.8	Entrée	DC 12V/24V
Température de fonctionnement	-4°F~158°F	Objectif	DC 5V-2.5A
Carte Micro SD	Prise en charge maximale de 512 Go	Garantie	18 Months

### Note:

En cas de problème lors de l'utilisation, nous offrons une garantie gratuite de 18 mois à partir de la date d'achat, ainsi qu'un support technique à vie.

### Service d'extension de garantie:

Après avoir enregistré vos informations sur [redtigercam.com](https://www.redtigercam.com), vous pouvez prolonger la garantie de 6 mois supplémentaires gratuitement.

URL: <https://www.redtigercam.com/pages/warranty-form>

## Boutons et Fonctions



### Bouton d'alimentation

Mode d'enregistrement:

- Appui court – Pour prendre un instantané
- Appuyez longuement pour éteindre la caméra

Mode d'installation:

- Appuyez brièvement – pour revenir à l'écran précédent

Mode de lecture:

- Appuyez brièvement – pour revenir à l'écran précédent



### Bouton de Menu

Mode d'enregistrement:

- Appuyez brièvement pour accéder au menu principal
- Appui long – Pour activer/désactiver le WiFi

Mode d'installation:

- Appui court – Pour entrer dans l'affichage de l'écran de veille

Mode de lecture:

- Appui court – Pour supprimer/verrouiller/déverrouiller le fichier spécifique



### Bouton Gauche

Mode d'enregistrement:

- Appui court – Pour verrouiller/déverrouiller le fichier d'enregistrement

Mode d'installation:

- Appuyez brièvement pour sélectionner la fonction précédente

Mode de lecture:

- Appuyez brièvement pour le rembobinage rapide



### **Bouton Droit**

Mode d'enregistrement:

- Appui court - Pour entrer en mode lecture

Mode d'installation:

- Appuyez brièvement pour sélectionner la fonction suivante

Mode de lecture:

- Appuyez brièvement pour sélectionner le fichier suivant
- Appuyez brièvement pour Avance rapide (lors de la lecture d'une vidéo)

### **Bouton OK**

Mode d'enregistrement :

- Appui court - Pour changer d'écran

Mode de configuration :

- Appui court - Pour entrer/confirmer des paramètres spécifiques

Mode lecture :

- Appui court - Pour sélectionner et lire le fichier spécifique

## • Mode Vidéo

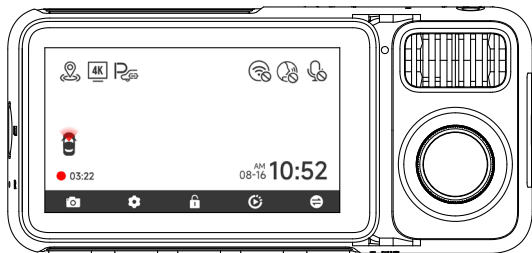

Vous pouvez cliquer manuellement sur le symbole  en haut de l'écran pour choisir si l'audio doit être enregistré pendant l'enregistrement vidéo.

Vous pouvez cliquer manuellement sur le symbole  en haut de l'écran pour choisir si le WLAN doit être activé.

Vous pouvez cliquer manuellement sur le symbole  en haut de l'écran pour choisir si vous souhaitez activer le contrôle vocal.

## Fonction de Contrôle Vocal

Contrôle rapide via commandes vocales simples.

Quand le symbole  est blanc, cela signifie que la fonction peut être utilisée normalement.

Il y a deux façons d'activer cette fonction.

- 1 Appuyez sur le symbole pour activer ou désactiver la fonction.
- 2 Accédez à Paramètres - Contrôle vocal - Activer/Désactiver.

lock the video	
take picture	
turn on Audio	turn off Audio
turn on screen	turn off screen
turn on wifi	turn off wifi
turn on recording	turn off recording
show front camera	show rear camera







### Note:

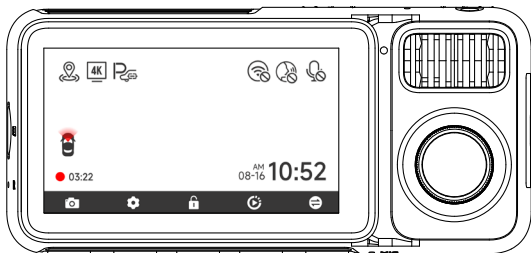



1. Vous pouvez voir des commandes spécifiques dans les paramètres de contrôle vocal.
2. La fonction de contrôle vocal ne supporte que l'anglais.

# Aperçu de l'interface d'utilisateur

- **Mode d'enregistrement**



Icône	Description
	Afficher le statut GPS
	Afficher la résolution d'enregistrement
	Indique si le kit câblé est connecté et si la surveillance de stationnement est activée
	Statut WiFi
	Contrôle vocal
	Statut d'enregistrement vocal

Icône	Description
	Quelle caméra est affichée
● 03:22	Statut et temps d'enregistrement
● 03:22	Enregistrement d'urgence activé
08-16 10:52 AM	Date et heure de la caméra
	Photographie
	Appui court pour entrer dans les paramètres. Appui long de 3 secondes pour activer ou désactiver le WiFi
	Enregistrement d'urgence. Appui court pour verrouiller la vidéo
	Lecture
	Changement entre les caméras avant, intérieure et arrière

## • Mode de Lecture

- 1 Appuyez sur le bouton M pour accéder au dossier de lecture.
- 2 Appuyez sur le bouton gauche ou droit pour sélectionner le dossier que vous souhaitez lire, puis appuyez sur le bouton M pour entrer.

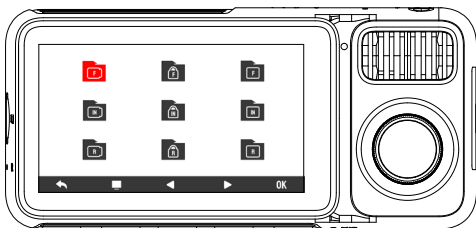

- 3 Appuyez sur le bouton OK pour regarder la vidéo enregistrée.
- 4 Appuyez longuement sur le bouton OK pendant 3 secondes pour éditer vos vidéos enregistrées.

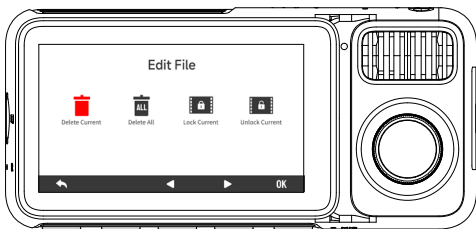























### Note:





Toutes les fonctions mentionnées ci-dessus peuvent être exécutées via l'écran tactile.

## Aperçu des Fonctionnalités

Appui court sur le bouton M pour entrer dans le menu des paramètres, où vous pouvez ajuster diverses fonctions

Icône	Fonction	Option/Description
	Résolution	2.7K+1080P+1080P+1080P/ 2.5K+1080P+1080P+1080P/ 1080P+1080P+1080P+1080P
	Audio	Activé/Désactivé
	Temps d'enregistrement	1/3/5 Minutes
	G-sensor	Désactivé/Faible/Moyen/Élevé
	Avertissement de Fatigue	Un rappel sera effectué après 1h/2h/3h/4h/Désactivé
	Wi-Fi	Activé/Désactivé
	Volume	Désactivé/Faible/Moyen/Élevé
	Cliquez Sur Le Son	Activé/Désactivé
	Son de Démarrage	Activé/Désactivé
	Écran de Veille	Désactivé/10 secondes/30 secondes/2 minutes
	Contrôle Vocal	Activé/Désacti/Commande vocale

Icône	Fonction	Option/Description
	Enregistrement Avant-Intérieur	Activé/Désactivé
	Enregistrement Arrière-Intérieur	Activé/Désactivé
	Image Miroir	Inversion Horizontale Vue Arrière *Caméra arrière requise
	Inversion Verticale de l'image	Inversion Verticale Vue Arrière *Caméra arrière requise
	Surveillance de Stationnement	Veuillez connecter le kit ACC
	GPS	Afficher la force du signal GPS
	Horodatage Date	Activé/Désactivé
	Horodatage Vitesse	Activé/Désactivé
	Horodatage GPS	Activé/Désactivé
	Unités de Vitesse	KM/H / MPH
	Langue	Choisissez votre langue préférée
	Réglage de l'horloge	Mise à jour par GPS
	Fuseau Horaire	12h/24h

Icône	Fonction	Option/Description
	Fuseau Horaire	Choisissez votre fuseau horaire
	Heure d'été	Heure d'été Activé/Désactivé
	Fréquence d'affichage	60Hz/50Hz
	Rappel de Formatage	Rappel de suppression de données
	Formater la Carte SD	Formater la carte SD. Toutes les données seront supprimées
	Test de Vitesse de Carte	Détection de vitesse de carte
	Réinitialiser les Paramètres	Réinitialiser à les paramètres d'origine
	APP	Un code QR pour l'application
	Informations Produit	Version du software
	Centre d'aide	Scanner le QR code pour contact

## Note:

- Pour garantir une expérience utilisateur fluide, il est recommandé de formater votre carte mémoire une fois par mois.
- Si vous désactivez le paramètre "Son de clique", les sons d'activation et de désactivation seront également supprimés.

## Mise à jour OTA (Over-the-air)

**Remarque :** Veuillez mettre à jour l'application à la dernière version pour utiliser cette fonction.

1. Déconnectez le téléphone mobile et le Wi-Fi de la caméra de tableau de bord. Connectez le téléphone au WLAN pendant 5 secondes, puis déconnectez-le. Enfin, connectez le Wi-Fi de la caméra de tableau de bord.
2. Une fois la connexion WiFi établie, ouvrez l'Application Redtiger Cam et commencez à l'utiliser. Si un nouveau logiciel est détecté, la page de l'app affichera la disponibilité de la mise à jour.
3. Pour effectuer la mise à niveau, cliquez sur "Mettre à niveau maintenant". L'application Redtiger vous invitera à télécharger le paquet de mise à niveau. Veuillez noter que le firmware réel doit prévaloir sur le paquet de mise à niveau.
4. Connectez la caméra de tableau de bord pour envoyer le paquet de mise à niveau. Ne mettez pas hors tension la caméra de tableau de bord pendant le processus de mise à niveau. Une fois la mise à niveau terminée, l'application affichera le message de réussite de la mise à niveau et la caméra de tableau de bord redémarrera automatiquement.

## Comment Regarder une Vidéo Sur un Ordinateur

Nous vous recommandons d'utiliser Lecteur REDTIGER comme lecteur vidéo approprié pour regarder/lire des vidéos. Il peut également afficher Carte Google.

Vous pouvez le télécharger gratuitement sur Mac ou Windows à partir du lien suivant: <https://www.redtigerscam.com/pages/gps-player>

Vous pouvez choisir différents modes de lecture dans Paramètres > mode de lecture vidéo. Et vous pouvez régler la vitesse de lecture, la langue, la carte et d'autres fonctions.

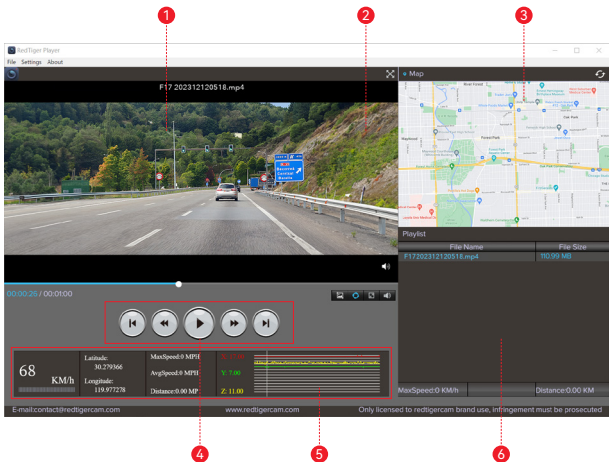

- 1 Fenêtre de lecture vidéo (avant)
- 2 Fenêtre de lecture vidéo (arrière)
- 3 Affichage de la carte et de la piste
- 4 Panneau de configuration de lecture
- 5 Indications de vitesse et d'état de conduite
- 6 Liste de lecture

**Note:**

Lorsque vous trouvez le fichier vidéo souhaité, maintenez le bouton gauche de la souris enfoncé et faites-le glisser sur le lecteur vidéo pour le lire.

## Installation

### **⚠ AVERTISSEMENT**

Assurez-vous de connecter toutes les caméras et tous les fils avant d'allumer l'écran de caméra, sinon la caméra ne fonctionnera pas correctement. Suivez les instructions ci-dessous pour installer votre tachygraphe de Redtiger pour la première fois.

- **Insérer une Carte Mémoire**

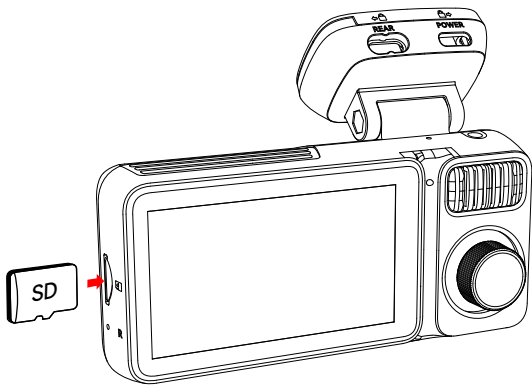

## • Installation de la Caméra Avant

Décrochez l'autocollant électrostatique du cellophane et transférez-le à l'endroit où vous souhaitez le coller. Fixez la caméra avant à l'autocollant électrostatique et appuyez pour la rendre plus ferme.

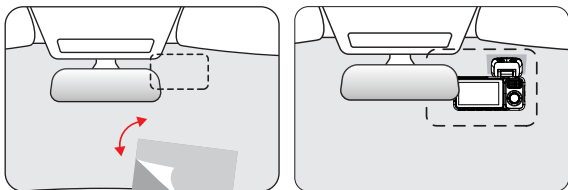

## • Disposition des Fils Sur le Véhicule

- 1 Le chargeur de voiture est connecté à la prise cigare.
- 2 Connectez l'autre extrémité de votre chargeur de voiture à votre tachygraphe.
- 3 Utilisez un pied-de-biche pour faire passer le cordon d'alimentation le long du pare-brise avant et du toit, et cachez le cordon d'alimentation sous le pilier A afin de ne pas obscurcir la vue du conducteur et de ne pas causer de danger.

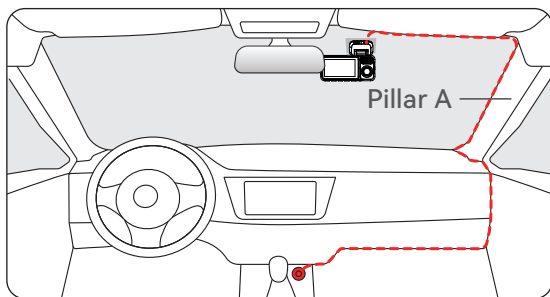

## • Installation de la Caméra Arrière

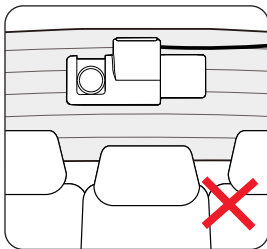
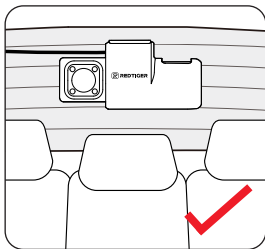
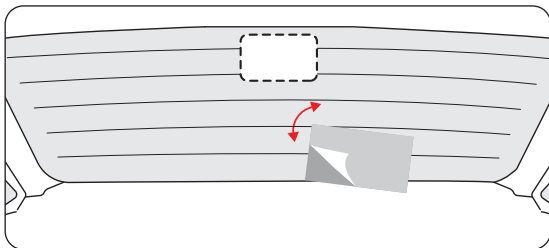

- 1 Assurez-vous que la caméra embarquée est orientée vers l'intérieur, avec le logo de la caméra vers le haut.
- 2 Allumez la caméra embarquée et vérifiez la vue de la caméra arrière pour confirmer la meilleure position.
- 3 Appliquez l'autocollant statique, fixez la caméra et réglez l'angle pour obtenir une vue optimale.

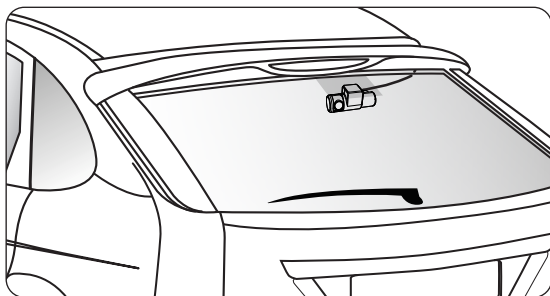



## Dépannage

### • Pourquoi pas de signal GPS?

1. Nettoyez et reconnectez la sonde sur l'unité principale et le support. Vérifiez toute interférence dans votre voiture, comme un film métallique sur le pare-brise, une antenne radio ou un détecteur de radar.
2. Déplacez votre voiture dans une zone dégagée.
3. Si l'icône GPS est  , cela signifie que le signal GPS est bon. Si l'icône GPS est  , cela signifie qu'il n'y a pas de signal GPS.

### • Pourquoi ma dash cam indique-t-elle une erreur de carte ou demande-t-elle de formater la carte mémoire de temps en temps?

Veuillez suivre les étapes suivantes pour vérifier :

1. Dans Définir > alertes de format, vérifiez si les alertes au format planifié sont activées.
2. Formatez la carte mémoire.
3. Réinitialisez et redémarrez le tachygraphe
4. Mettez à jour le micrologiciel.

### • Redémarrage répété de la dash cam/pas de démarrage?

1. Assurez-vous d'utiliser le chargeur de voiture d'origine.
2. Débranchez la carte mémoire et le chargeur de voiture tour à tour, puis réinstallez-les. Vérifiez si le court-circuit est causé par des accessoires.
3. Réinitialisez l'appareil via le petit trou en bas de l'enregistreur de conduite.
4. Si aucune des solutions ci-dessus ne résout le problème, essayez de brancher le câble USB pour vérifier si l'appareil principal peut être utilisé normalement.
5. Veuillez vous rendre sur le site officiel pour mettre à jour le micrologiciel.
6. S'il ne peut pas être résolu, veuillez contacter notre service à la clientèle professionnel pour un remplacement.

### • Pourquoi ne puis-je pas me connecter au Wi-Fi?

1. Vérifiez la distance de travail de Wi-Fi, environ 15 pieds.
2. Vérifiez le SSID et le mot de passe du Wi-Fi ou si d'autres appareils sont connectés au Wi-Fi.
3. Désactivez les données mobiles, les logiciels de sécurité et les VPN sur votre téléphone.
4. Si le problème persiste, contactez le soutien à la clientèle pour obtenir de l'aide.

### • Pourquoi l'heure est-elle mal réglée?

Le tachygraphe est doté d'un GPS intégré. Il ajuste automatiquement l'heure en fonction de votre emplacement et de votre fuseau horaire, éliminant ainsi le besoin de modifier manuellement l'heure. Vous pouvez régler l'heure en Régplant > Fuseau horaire/heure d'été.

Specifiche del Prodotto . . . . .	<b>60</b>
Pulsanti e Funzioni . . . . .	<b>61</b>
Funzione Controllo Vocale . . . . .	<b>64</b>
Panoramica dell'interfaccia Utente. . . . .	<b>65</b>
Panoramica delle Funzioni . . . . .	<b>68</b>
Aggiornamento OTA (Over-the-air) . . . . .	<b>71</b>
Come Guardare un Video Su un Computer . . . . .	<b>71</b>
Installazione . . . . .	<b>73</b>
Risoluzione dei Problemi . . . . .	<b>76</b>

## Specifiche del Prodotto

Nome articolo	F17 Plus Dash Cam	Formato video	MP4
Dimensioni dello schermo	3" IPS	Formato foto	JPG
Registrazione Risoluzione	Anteriore 2.7K + Interno anteriore 1080P + Interno posteriore 1080P + Posteriore 1080P		
Obiettivo	F1.8	Ingresso	DC 12V/24V
Temperatura Operativo	-4°F~158°F	Uscita	DC 5V-2.5A
Scheda Micro SD	Supporto massimo 512GB	Garanzia	18 mesi

### Nota:

In caso di problemi durante l'uso, offriamo una garanzia gratuita di 18 mesi dalla data di acquisto, oltre al supporto tecnico a vita.

### Servizio di garanzia estesa:

Dopo aver registrato le informazioni su [redtigercam.com](https://www.redtigercam.com), è possibile estendere la garanzia per ulteriori 6 mesi gratuitamente.

URL: <https://www.redtigercam.com/pages/warranty-form>

## Pulsanti e Funzioni



### Pulsante di Accensione

Modalità di registrazione:

- Pressione breve - Per scattare un'istantanea
- Premere a lungo-per spegnere la fotocamera

Modalità di configurazione:

- Premere brevemente per tornare alla schermata precedente

Modalità di riproduzione:

- Premere brevemente per tornare alla schermata precedente



### Pulsante Menu

Modalità di registrazione:

- Premere brevemente per accedere al menu principale
- Pressione lunga - Per attivare/disattivare il WiFi

Modalità di configurazione:

- Premere brevemente per immettere/confermare impostazioni specifiche

Modalità di riproduzione:

- Pressione breve - Per entrare nella visualizzazione del salvaschermo



### Pulsante Sinistro

Modalità di registrazione:

- Pressione breve - Per bloccare/sbloccare il file di registrazione

Modalità di configurazione:

- Premere brevemente per selezionare la funzione precedente

Modalità di riproduzione:

- Premere brevemente per riavvolgere velocemente



### **Pulsante Destro**

Modalità di registrazione:

- Pressione breve - Per entrare nella modalità di riproduzione

Modalità di configurazione:

- Premere brevemente per selezionare la funzione successiva

Modalità di riproduzione:

- Premere brevemente per selezionare il file successivo
- Premere brevemente per avanzare velocemente

**OK**

### **Pulsante OK**

Modalità di registrazione:

- Pressione breve - Per cambiare schermo

Modalità di configurazione:

- Pressione breve - Per entrare/confermare impostazioni specifiche

Modalità di riproduzione:

- Pressione breve - Per selezionare e riprodurre il file specifico

## • Modalità Video

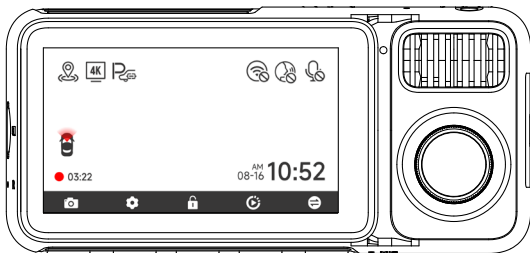

Puoi manualmente cliccare sul simbolo  in alto sul schermo per scegliere se registrare audio durante la registrazione video.

Puoi manualmente cliccare sul simbolo  in alto sul schermo per scegliere se attivare Wi-Fi.

Puoi manualmente cliccare sul simbolo  in alto sul schermo per scegliere se attivare il controllo vocale.

## Funzione Controllo Vocale

Controllo rapido tramite semplici comandi vocali.

Quando il simbolo  è bianco, significa che la funzione può essere usata normalmente.

Ci sono due modi per attivare questa funzione.

- 1 Tocca il simbolo per attivare o disattivare la funzione.
- 2 Vai a Impostazioni - Controllo vocale - ON/OFF.

lock the video	
take picture	
turn on Audio	turn off Audio
turn on screen	turn off screen
turn on wifi	turn off wifi
turn on recording	turn off recording
show front camera	show rear camera





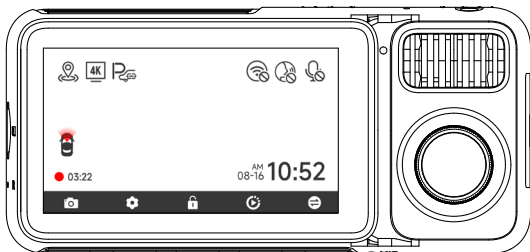

### Nota:

1. Puoi vedere comandi specifici nelle impostazioni del controllo vocale.
2. La funzione controllo vocale supporta solo inglese.

# Panoramica dell'interfaccia Utente

## • Modalità di Registrazione



Icona	Descrizione
	Mostra stato GPS
	Mostra risoluzione di registrazione
	Se il kit hardwire è collegato e monitoraggio parcheggio è attivato
	Stato WiFi
	Controllo vocale
	Stato di registrazione vocale

Icona	Descrizione
	Quale fotocamera viene visualizzata
● 03:22	Stato e tempo di registrazione
● 03:22	Registrazione di emergenza attivata
08-16 10:52 AM	Data e ora della camera
	Fotografia
	Pressione breve per accedere alle impostazioni. Pressione lunga per 3 secondi per accendere o spegnere il WiFi
	Registrazione d'emergenza. Pressione breve per bloccare il video
	Riproduzione
	Passaggio tra fotocamere anteriore, interna e posteriore

## • Modalità di Riproduzione

- 1 Premi il pulsante M per accedere alla cartella di riproduzione.
- 2 Premi il pulsante sinistro o destro per selezionare la cartella che vuoi riprodurre, quindi premi il pulsante M per entrare.

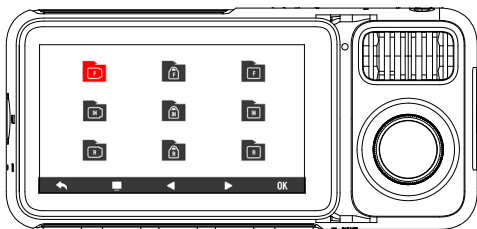

- 3 Premi il pulsante OK per guardare il video registrato.
- 4 Tieni premuto il pulsante OK per 3 secondi per modificare i tuoi video registrati.

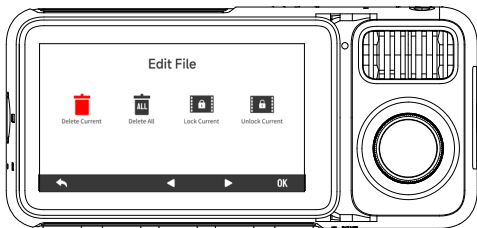











### **Nota:**











Tutte le funzioni sopra menzionate possono essere eseguite tramite touchscreen.

## Panoramica delle Funzioni

Pressione breve del pulsante M per accedere al menu delle impostazioni, dove è possibile regolare varie funzioni.

Icona	Funzione	Opzione/Descrizione
	Risoluzione	2.7K+1080P+1080P+1080P/ 2.5K+1080P+1080P+1080P/ 1080P+1080P+1080P+1080P
	Audio	Acceso/Spento
	Durata registrazione	1/3/5mins
	G-sensor	Disattivato/Basso/Medio/Alto
	Avviso Fatica	Un promemoria sarà attivato dopo 1h/2h/3h/4h/Disattivato
	Wi-Fi	Acceso/Spento
	Volume	Disattivato/Basso/Medio/Alto
	Tono Click	Acceso/Spento
	Suono di avvio	Acceso/Spento
	Salvaschermo	Disattivato/ 10 secondi/30 secondi/2 minuti
	Controllo vocale	Acceso/Spento/Comando vocale

Icona	Funzione	Opzione/Descrizione
	Registrazione Interna-Anteriore	Acceso/Spento
	Registrazione Interna-Posteriore	Acceso/Spento
	Inversione Orizzontale	Inversione Orizzontale Vista Posteriore *È necessario collegare la camera posteriore
	Inversione Verticale Camera Posteriore	Inversione Verticale Vista Posteriore *È necessario collegare la camera posteriore
	Monitoraggio Parcheggio	Collegare il kit cablato ACC
	GPS	Visualizza intensità segnale GPS
	Timbratura Data	Acceso/Spento
	Timbratura Velocità	Acceso/Spento
	Timbratura GPS	Acceso/Spento
	Unità Velocità	KM/H / MPH
	Lingua	Scegli la Lingua Preferita
	Impostazioni Orologio	Aggiorna con GPS
	Formato Ora	12h/24h

Icona	Funzione	Opzione/Descrizione
	Fuso Orario	Scegli il Tuo Fuso Orario
	Ora Legale	Ora Legale Acceso/Spento
	Frequenza	60Hz/50Hz
	Promemoria Formattazione	Promemoria per Cancellare Dati
	Formatta Scheda SD	Formatta scheda SD. Tutti i dati verranno eliminati
	Test Velocità Scheda	Rilevamento Velocità Scheda
	Reimposta Impostazioni	Ripristina Tutte le Impostazioni
	APP	Un QR Code per l'app
	Informazioni sul Prodotto	Versione Software
	Centro Assistenza	Scansiona il QR Code per contattarci

## Nota:

- Per garantire un'esperienza utente fluida, si consiglia di formattare la scheda di memoria una volta al mese.
- Se si cambia la impostazione Tono click su OFF, anche i toni di attivazione e disattivazione saranno disabilitati.

## Aggiornamento OTA (Over-the-air)

**Nota:** Si prega di aggiornare l'APP all'ultima versione per utilizzare questa funzione.

1. Disconnetti il telefono cellulare e il Wi-Fi della dash cam. Connetti il telefono al WLAN per 5 secondi, quindi disconnetti. Infine, connetti il Wi-Fi della dash cam.
2. Una volta stabilita la connessione Wi-Fi, aprire l'app per Redtiger Cam per utilizzarla. Se viene rilevato un nuovo software, la pagina App indicherà la disponibilità di un aggiornamento.
3. Per eseguire l'aggiornamento, clicca su "Aggiorna ora". L'app Redtiger ti inviterà a scaricare il pacchetto di aggiornamento. Si prega di notare che il firmware effettivo dovrebbe prevalere sul pacchetto di aggiornamento.
4. Connetti la dash cam per inviare il pacchetto di aggiornamento. Non spegnere la dash cam durante il processo di aggiornamento. Una volta completato l'aggiornamento, l'APP visualizzerà il messaggio di successo dell'aggiornamento e la dash cam si riavvierà automaticamente.

## Come Guardare un Video Su un Computer

Si consiglia di utilizzare REDTIGER Player come lettore video corretto per guardare/riprodurre video. Può anche visualizzare Google Maps.

È possibile scaricarlo gratuitamente su Mac o Windows dal collegamento seguente: <https://www.redtigercam.com/pages/gps-player>

Puoi scegliere diverse modalità di riproduzione in Impostazioni > modalità di riproduzione video. E puoi impostare velocità di riproduzione, lingua, mappa e altre funzioni.

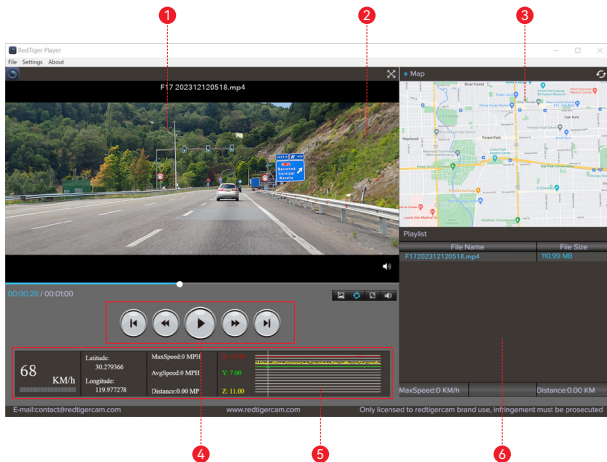

- 1 Finestra di riproduzione video (anteriore)
- 2 Finestra di riproduzione video (posteriore)
- 3 Visualizzazione mappa e traccia
- 4 Pannello di controllo riproduzione
- 5 Indicazione della velocità e dello stato di guida
- 6 Elenco di riproduzione

### Nota:

Quando trovi il file video desiderato, tieni premuto il pulsante sinistro del mouse e trascinalo sul lettore video per riprodurlo.

## Installazione

### **⚠ ATTENZIONE**

Assicurarsi di collegare tutte le videocamere e i cavi prima di accendere lo schermo della fotocamera, altrimenti la fotocamera non funzionerà correttamente. seguire le istruzioni Di seguito per la prima installazione della Dash cam Redtiger.

- **Inserire la Scheda di Memoria**

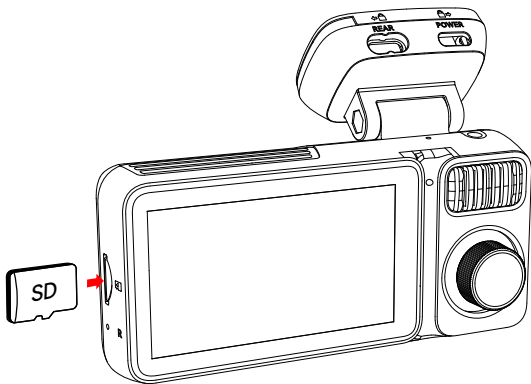

## • Installazione della Fotocamera Anteriore

Stacca l'adesivo elettrostatico dal cellophane e trasferiscilo dove desideri attaccarlo. Attacca la fotocamera anteriore all'adesivo elettrostatico e premi per renderla più salda.

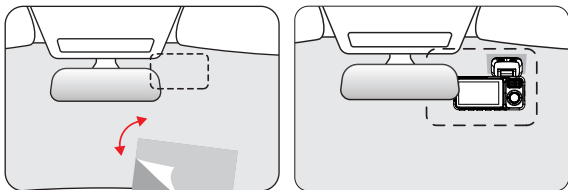

## • Disposizione dei Fili nel Veicolo

- 1 Il caricabatterie per auto è collegato alla presa per sigari.
- 2 Collegare l'altra estremità del caricabatterie per auto alla telecamera del cruscotto.
- 3 Utilizzare il palanchino per far scorrere il cavo di alimentazione lungo la parte anteriore parabrezza e tetto, e nascondere il cavo nel Pilastro A, in modo da non bloccare la visuale del conducente e causare pericolo.

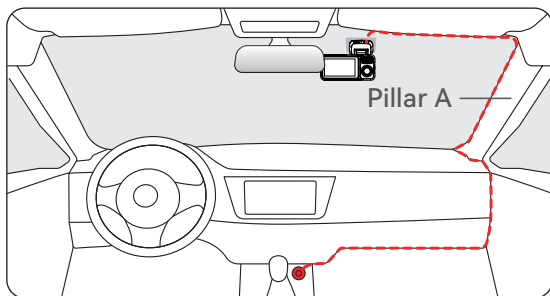

## • Installazione della Fotocamera Posteriore

- 1 Assicurati che la Cabin Cam sia rivolta verso l'interno, con il logo della telecamera rivolto verso l'alto.
- 2 Accendi la dash cam e controlla la visuale della telecamera posteriore per confermare la posizione migliore.
- 3 Applica l'adesivo statico, monta la telecamera e regola l'angolazione per una visuale ottimale.

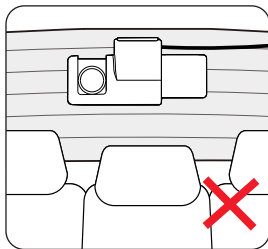
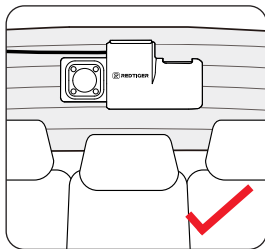
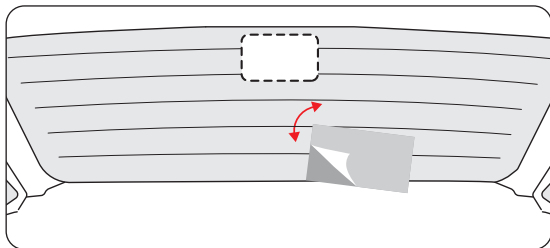

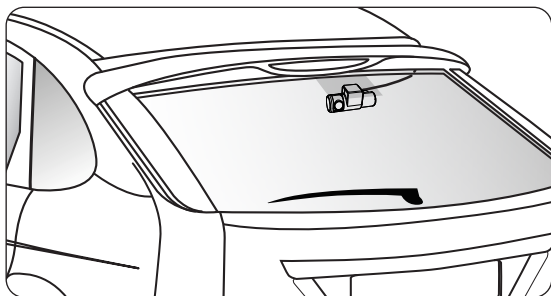

## Risoluzione dei Problemi

### • Perché non c'è segnale GPS?

1. Pulire e ricollegare la sonda sull'unità principale e sul supporto. Controllare eventuali interferenze nella vostra auto, come pellicola metallica sul parabrezza, antenna radio o rilevatore radar.
2. Spostare l'auto in un'area aperta.

3. Se l'icona GPS è  , significa che il segnale GPS è buono.

Se l'icona GPS è  , significa che non c'è segnale GPS.

### • Perché la mia dash cam segnala errore della scheda o chiede di formattare la scheda di memoria di tanto in tanto?

Seguire i passaggi riportati di seguito per verificare:

1. Accedere a Impostazioni > Formatta promemoria per verificare se il promemoria formato normale è attivato.
2. Formattare la scheda di memoria.
3. Ripristinare le impostazioni di fabbrica e riavviare la Dash cam.
4. Aggiornare il firmware.

• **La dash cam si riavvia ripetutamente/non si avvia?**

1. Assicurarsi di utilizzare il caricabatterie per auto originale.
2. Scollegare la scheda di memoria e il caricabatterie per auto a turno e reinstallarli. Controllare se il corto circuito è causato dagli accessori.
3. Resetare la macchina attraverso il piccolo foro nella parte inferiore del registratore di guida.
4. Se nessuna delle soluzioni sopra indicate può risolvere il problema, provare ad accendere il cavo USB per confermare se l'host può essere utilizzato normalmente.
5. Visitare il sito Web ufficiale per aggiornare il firmware.
6. Se il problema persiste, contattare il nostro servizio clienti dedicato per una sostituzione.

• **Perché non è possibile connettersi al Wi-Fi?**

1. Controllare la distanza di lavoro del Wi-Fi, circa 15 piedi.
2. Verificare l'SSID e la password del Wi-Fi o se sono presenti altri dispositivi connessi al Wi-Fi.
3. Disattivare i dati mobili, il software di sicurezza e la VPN sul telefono.
4. Se il problema persiste, contattare l'assistenza clienti per assistenza.

• **Perché l'impostazione dell'ora non è corretta?**

La Dash cam è dotata di GPS integrato. Regola automaticamente l'ora in base alla posizione e al fuso orario, eliminando la necessità di modifiche manuali dell'ora. È inoltre possibile regolare l'ora tramite Impostazioni > fuso orario/ora legale.

# Contenido

ES

Producto Especificaciones . . . . .	79
Botones y Funciones . . . . .	80
Función de Control Por Voz . . . . .	83
Interfaz de Usuario . . . . .	84
Descripción General de Funciones . . . . .	87
Actualizaciones por Aire. . . . .	90
Cómo Reproducir Video en el Ordenador . . . . .	90
Instalación . . . . .	92
Solución de Problemas . . . . .	95

## Producto Especificación

Nombre del artículo	F17 Plus Cámara de Tablero	Formato de vídeo	MP4
Tamaño de pantalla	3" IPS	Formato de foto	JPG
Resolución de grabación	Frontal 2.7K+Frontal Cabina 1080P+ Trasera Cabina 1080P+Trasera 1080P		
Lente	F1.8	Entrada	DC 12V/24V
Temperatura de funcionamiento	-4°F~158°F	Salida	DC 5V-2.5A
Tarjeta Micro SD	Max Support 512GB	Período de garantía	18 meses

### Nota:

Si tiene algún problema durante el uso, le proporcionaremos 18 meses de reemplazo gratuito y soporte técnico de por vida.

\* El período de garantía específico está sujeto a las leyes locales.

### Servicio de garantía ampliada:

Después de registrar la información en [redtigercam.com](https://www.redtigercam.com), puede ampliar la garantía durante 6 meses adicionales de forma gratuita.

URL: <https://www.redtigercam.com/pages/warranty-form>

## Botones y Funciones



### Botón de Encendido

Modo Grabación:

- Pulsación corta-para tomar una instantánea
- Pulsación larga: para apagar la cámara

Modo Configuración::

- Pulsación corta: para volver a la pantalla anterior

Modo Reproducción:

- Pulsación corta: para volver a la pantalla anterior



### Botón de Menú

Modo Grabación:

- Pulsación corta: entra en el menú principal
- Pulsación larga: para activar/desactivar WiFi

Modo Configuración:

- Pulsación corta: para acceder al salvapantallas

Modo Reproducción:

- Pulsación corta-para borrar/bloquear/desbloquear el archivo específico



### Botón Izquierdo

Modo Grabación:

- Pulsación corta: para bloquear/desbloquear el archivo de grabación

Modo Configuración:

- Pulsación corta: para seleccionar la función anterior

Modo Reproducción:

- Pulsación corta: para rebobinar rápidamente mientras se reproduce el vídeo.



### **Botón Derecho**

Modo de grabación:

- Pulse brevemente para acceder al modo de reproducción

Modo Configuración:

- Pulsación corta: para seleccionar la siguiente función

Modo Reproducción:

- Pulsación corta: para seleccionar el archivo siguiente
- Pulse brevemente para avanzar rápidamente vídeo

### **Botón OK**

Modo Grabación:

- Pulsación corta: para cambiar de pantalla

Modo Configuración:

- Pulsación corta: para introducir/confirmar ajustes específicos

Modo Reproducción:

- Pulsación corta: para seleccionar y reproducir un archivo específicos

## • Video Mode

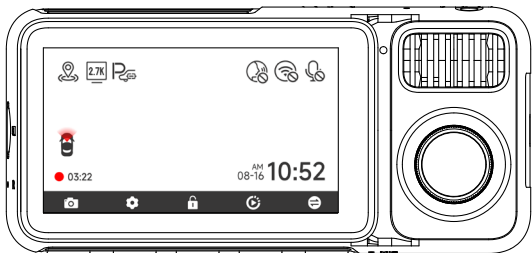

Puedes hacer clic manualmente en el icono  en la parte superior de la pantalla para elegir si activar el control por voz.

Puedes hacer clic manualmente en el icono  en la parte superior de la pantalla para elegir si encender el Wi-Fi.

Puedes hacer clic manualmente en el icono  en la parte superior de la pantalla para elegir si grabar audio durante la grabación de video.

## Función de Control Por Voz

Control rápido a través de comandos de voz simples

Si el icono es blanco



significa que la función puede ser utilizada normalmente.

Tiene dos maneras de habilitar esta función.

Toque en el icono para activar o desactivar la función.

Introduzca el modo de ajuste-vioce control-on/off.

lock the video	
take picture	
turn on audio	turn off audio
turn on screen	turn off screen
turn on wifi	turn off wifi
turn on recording	turn off recording
show front camera	show rear camera

### Note:

1. Puede ver los comandos específicos en el control setting-vioce.
2. la función de control de voz solo admite inglés.

# Interfaz de Usuario

## • Modo de Grabación

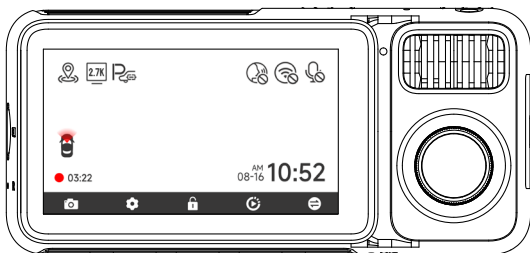

Icono	Descripción
	Estado del GPS
	Resolución de la cámara frontal
	Posibilidad de conectar el kit de cableado y configurar el control de aparcamiento
	Control por voz
	Estado de Wi-Fi
	Estado de la grabación de voz

Icono	Descripción
	Qué cámara se está visualizando
● 03:22	Estado y tiempo de grabación
● 03:22	Grabación de emergencia activada
07:20 <sup>PM</sup>	Fecha y hora de la cámara
	Fotografía
	Pulsación corta para entrar en ajustes. Pulsación larga durante 3 segundos para activar o desactivar WiFi
	Grabación de emergencia
	Reproducción
	Switching from front, inside and rear cameras

## • Modo de Reproducción

- 1 Presione el > botón para acceder a la carpeta de reproducción.
- 2 Presione el botón Izquierdo o Derecho para seleccionar la carpeta que desea reproducir, luego presione el botón **OK** para entrar.

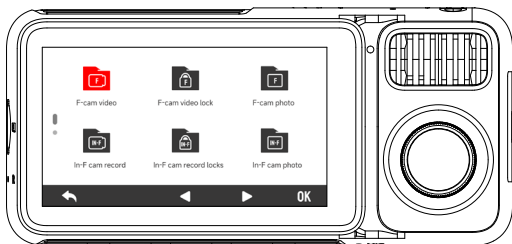

- 3 Presione el botón Aceptar para ver el video registrado.
- 4 Mantenga presionado el botón Aceptar durante 3 segundos para editar sus videos registrados.

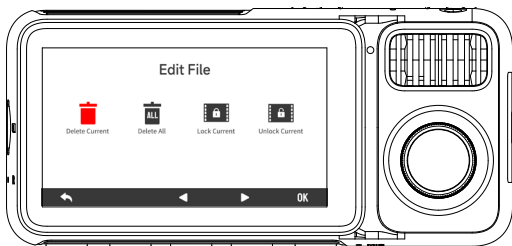













### **Nota:**

All of the above functions can be done via the touch screen.

## Descripción General de Funciones

Pulse brevemente el botón M para acceder al menú de configuración, donde podrá ajustar varias funciones.

Icono	Función	Opción/Descripción
	Resolución	2.7K+1080P+1080P+1080P/ 2.5K+1080P+1080P+1080P/ 1080P+1080P+1080P+1080P
	Audio	Encendido/Apagado
	Grabación en Bucle	1/3/5mins
	Sensor G	Apagado/Bajo/Medio/Alto
	Conducción Fatigada	Se realizará un recordatorio durante 1 hora /2 horas/3 horas/Apagado
	Wi-Fi	Encendido/Apagado
	Volumen	Apagado/Bajo/Intermedio/Alto
	Tono de Clic	Encendido/Apagado
	Sonido de Inicio	Encendido/Apagado
	Protector de pantalla	Apagado/10 segundos/30 segundos/2 minutos
	Control de Voz	Encendido/Apagado/Comando de voz

Icono	Función	Opción/Descripción
	Interrupción de grabación interna - frontal	Encendido/Apagado
	Interrupción de grabación interna - Trasera	Encendido/Apagado
	Voltear Espejo	Voltear la vista trasera horizontalmente * La cámara posterior debe estar conectada
	Voltear Cámara Trasera	Voltear la vista trasera verticalmente * La cámara posterior debe estar conectada
	Modo de Aparcamiento	Conecte el kit de cableado ACC
	GPS	Muestra la intensidad de la señal GPS
	Sello de Fecha	Encendido/Apagado
	Sello de Velocidad	Encendido/Apagado
	Sello GPS	Encendido/Apagado
	Unidades de Velocidad	KM/H / MPH
	Idioma	Seleccione su idioma preferido
	Fecha / Hora	Actualizar con GPS
	Formato de Hora	12h/24h

Icono	Función	Opción/Descripción
	Zona Horaria	Elija su zona horaria
	DST	Horario de verano Encendido/Apagado
	Frecuencia	60Hz/50Hz
	Recordatorio de Formato	Recordatorio para borrar datos
	Formatear	Formatee la tarjeta de memoria Se borrarán todos los datos
	Velocidad de la Tarjeta	Detección de la velocidad de la tarjeta
	Ajuste por Defecto	Restablecer todos los ajustes
	APP	Un código QR para la app
	Versión	Versión del software
	Centro de Ayuda	Escanee el código QR para ponerse en contacto con nosotros

## Nota:

- Para garantizar una experiencia de usuario sin problemas, se recomienda formatear el tarjeta TF una vez al mes.
- Cuando ajuste la opción Tono de clic a APAGADO, también se apagarán los sonidos de arranque y apagado.

## Actualizaciones por Aire

**Nota:** Por favor, actualice actualizar la APP a la última versión para utilizar esta función.

1. Desconecte el teléfono móvil y la dash cam Wi-Fi. 2. Conecte el teléfono a lan durante 5 segundos y, a continuación, desconéctelo. Por último, conecte la dash cam Wi-Fi.
2. Una vez que la conexión Wi-Fi se haya realizado correctamente, abra la APP Redtiger para empezar a utilizarla. Si se detecta un nuevo software, la página de la APP indicará la disponibilidad de una actualización.
3. Para actualizar, haga clic en "Actualizar ahora". La APP Redtiger le pedirá que descargue el paquete de actualización. Tenga en cuenta que el firmware actual debe prevalecer sobre el paquete de actualización.
4. Conecte la dash cam para enviar el paquete de actualización. No apague la dash cam durante el proceso de actualización. Una vez finalizada la actualización, la APP mostrará el mensaje de actualización correcta y la dash cam se reiniciará automáticamente.

## Cómo Reproducir Video en el Ordenador

Recomendamos utilizar REDTIGER Player como el reproductor de vídeo adecuado para ver/reproducir vídeos. También puede ver Google Maps.

Puede descargarlo gratuitamente en Mac o Windows desde el siguiente enlace: <https://www.redtigercam.com/pages/gps-player>

Puedes elegir diferentes modos de reproducción en Ajustes>modo de reproducción de vídeo. Y puedes configurar la velocidad de reproducción, el idioma, el mapa y otras funciones.

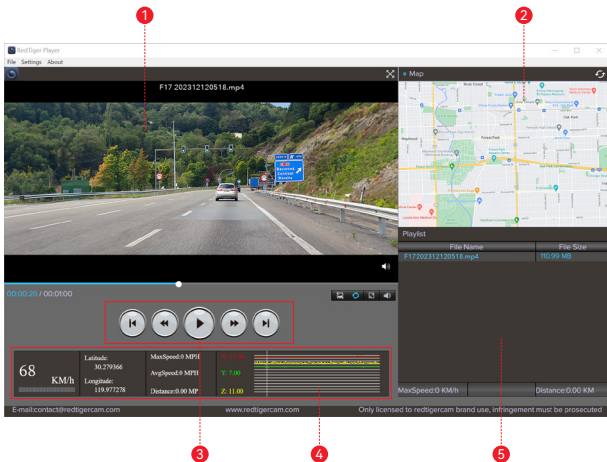

- 1** Ventana de reproducción de video (frontal)
- 2** Visualización de mapas y pistas
- 3** Panel de control de reproducción
- 4** Indicación de velocidad y estado de conducción
- 5** Lista de reproducción

### Nota:

Cuando encuentre el archivo de video deseado, mantenga pulsado el botón izquierdo del ratón y arrástrelo y suéltelo en el reproductor de video para reproducirlo.

## Instalación

### ⚠ ADVERTENCIA

Por favor, asegúrese de conectar todas las cámaras y cables antes de encender la pantalla de la cámara, de lo contrario, la cámara no puede funcionar correctamente. Por favor, siga las siguientes instrucciones para la primera instalación de la redtiger dash cam.

- **Inserte la tarjeta de memoria**

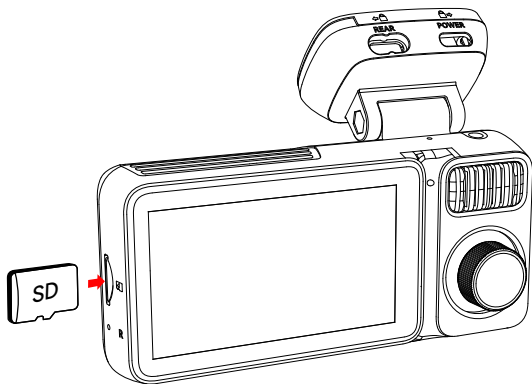

## • Instalación de la cámara frontal

Despegue la pegatina electrostática del celofán y transfírela al lugar donde desee pegarla. Pega la cámara frontal a la pegatina electrostática y presiona para que quede más firme.

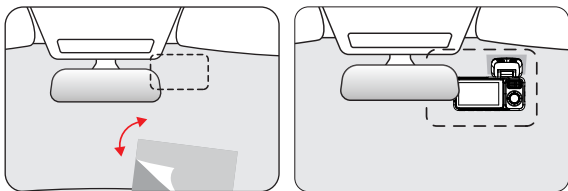

## • Disposición de los cables en el vehículo

- 1 El cargador de coche se conecta a la toma de corriente.
- 2 Conecta el otro extremo del cargador de coche a la cámara del salpicadero.
- 3 Utilice la palanca para pasar el cable de alimentación a lo largo del parabrisas delantero y el techo, y ocultar el cable por el pilar A, a fin de no bloquear la vista del conductor y causar peligro.

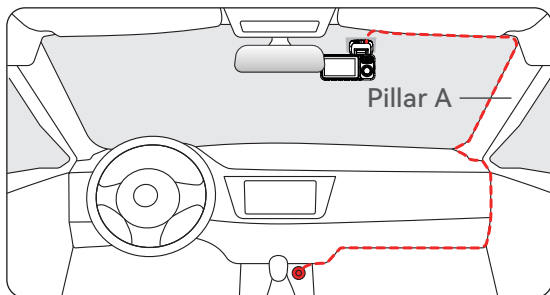

## • Instalación de la cámara trasera

- 1 Asegúrate de que la cámara de la cabina esté orientada hacia adentro, con el logo de la cámara mirando hacia arriba.
- 2 Enciende la cámara del tablero y revisa la vista de la cámara trasera para confirmar la mejor posición.
- 3 Aplica la etiqueta estática, monta la cámara y ajusta el ángulo para obtener la vista óptima.

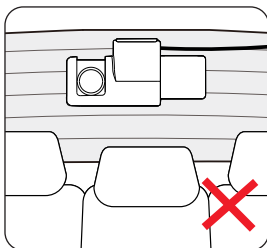
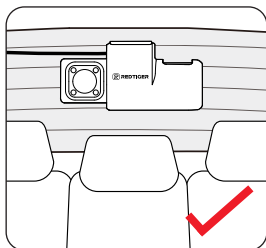
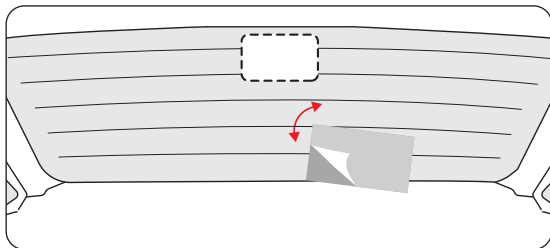

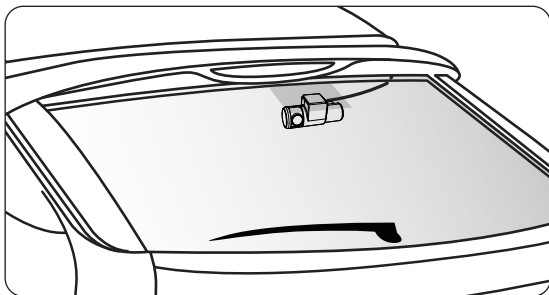

## Solución de Problemas

### • ¿Por qué no hay señal GPS?

1. Limpie y vuelva a conectar la sonda de la unidad principal y el soporte. Compruebe si hay alguna interferencia en su coche, como película metálica en el parabrisas, antena de radio o detector de radar.
2. Mueva su coche a una zona abierta.
3. Si el icono GPS es  , significa que la señal GPS es buena.

Si el icono de GPS es  , significa que no hay señal de GPS.

### • ¿Por qué mi dash cam indica error de tarjeta o por favor formatee la tarjeta de memoria de vez en cuando?

Por favor, siga los siguientes pasos para comprobarlo:

1. Por favor, vaya a Configuración > Recordatorio de Formato para comprobar si el recordatorio de formato regular está habilitado.
2. Formatee la tarjeta de memoria.
3. Restaure la configuración de fábrica y reinicie la dash cam.

4. Actualice el firmware.

• **¿Dash cam repetido reinicio/sin arranque?**

1. Asegúrese de que está utilizando el cargador de coche original.
2. Desenchufe la tarjeta de memoria y el cargador de coche y vuelva a instalarlos. Compruebe si el cortocircuito es causado por los accesorios.
3. Reinicie la máquina a través del pequeño orificio situado en la parte inferior de la grabadora de conducción.
4. Si nada de lo anterior puede resolver el problema, por favor, intente encender el cable USB para confirmar si el host se puede utilizar normalmente.
5. Por favor, vaya a la página web oficial para actualizar el firmware.
6. Si no se resuelve, por favor, póngase en contacto con su servicio de atención al cliente dedicado para un reemplazo.

• **¿Por qué no puedo conectarme a Wi-Fi?**

1. Compruebe la distancia de trabajo de Wi-Fi, alrededor de 15 pies.
2. Compruebe el SSID y la contraseña del Wi-Fi, o si hay otros dispositivos conectados al Wi-Fi.
3. Desactive los datos móviles, el software de seguridad y VPN en su teléfono.
4. Si el problema persiste, póngase en contacto con el servicio de atención al cliente para obtener ayuda.

• **¿Por qué la hora es incorrecta?**

La dash cam incorpora GPS. Ajusta automáticamente la hora en función de su ubicación y zona horaria, eliminando la necesidad de cambios de hora manuales. Y puedes ajustar la hora a través de Ajustes > Zona Horaria/DST.

## Customer Service Center

If you have any problems using or installing the dash cam, please contact us with any questions.



Help Center



WhatsApp



### For more information:

After sales: [help@redtigercam.com](mailto:help@redtigercam.com)

Business Cooperation: [contact@redtigercam.com](mailto:contact@redtigercam.com)

Customer Phone Service: +1 888 966 8028 (US)



# REDTIGER

Truly Peace of Mind™

Check us out here.  
Product and service are the foundation of Redtiger.

Instagram: @redtiger\_dashcam  
Facebook: Redtiger Dash Cam



[www.redtigerscam.com](http://www.redtigerscam.com)