

Bolt™

Inspiration strikes.



VS-260S

TTL AUTOFOCUS FLASH

User's Manual



Copyright © 2015 Gradus Group.

Bolt and other names of Bolt products are trademarks of Gradus Group. Other product and corporate names mentioned herein are trademarks of their respective holders.



Introduction

Thank you for choosing the Bolt VS-260S TTL Autofocus Flash. This flash unit combines a compact design with versatile features to give you both automatic ease of use and creative lighting control. Among the benefits you'll enjoy:

- Full compatibility with Sony's TTL metering system
- Adjustable five-position flash head
- Autofocus-assist for low-light photography
- Rear-curtain sync
- Automatic power-saving function



Bolt™
VS-260S

OFF ON

TEST/
READY

TTLOK

LOCK

MENU 

Contents

Overview	6–7
Warnings	8–10
Installing Batteries	10–11
Mounting the Flash	12–13
Turning on the Flash and Firing a Test	14
Taking Photos	15
Using Red-Eye Reduction.....	16
Using Flash Exposure Compensation.....	16–17
Using the Autofocus-Assist Light.....	17
Bouncing Your Flash.....	18–19
Using Rear- or Second-Curtain Synchronization	20
Troubleshooting	21
Specifications	22
Warranty.....	23

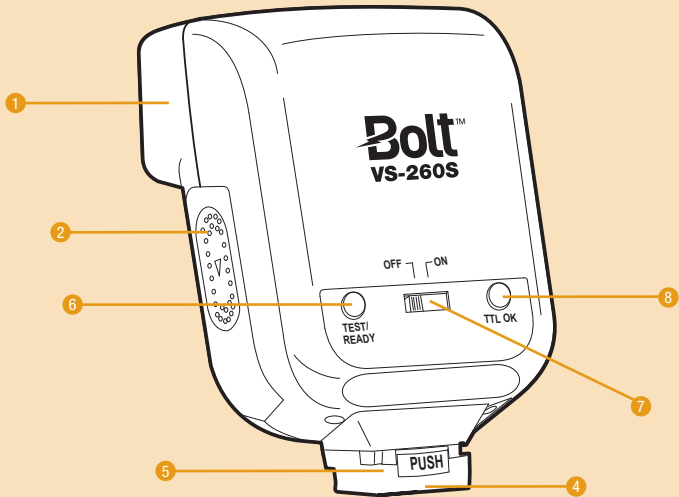

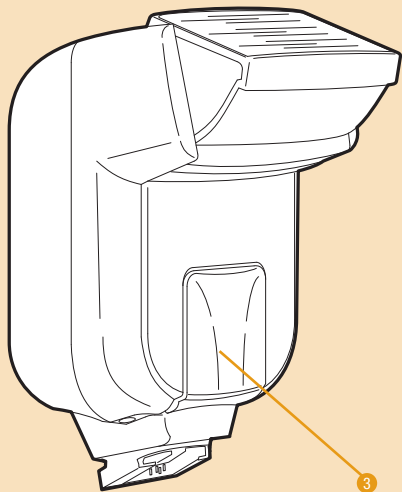

Overview

1. Flash head
2. Battery compartment cover
3. Autofocus-assist light
4. Mounting foot
5. Mounting foot lock
6. Test button / Ready light
7. Power switch
8. Automatic exposure confirmation light

Warnings

Before using your VS-260S, please read the following safety notices carefully and thoroughly to ensure safe use, and to help prevent damage to your flash or injury to yourself or others.

- Do not fire the flash at close range directly into the eyes of people or animals. This can cause damage to the retina and may even lead to blindness.
- To avoid overheating and damaging your flash unit, please wait for at least 10 minutes after 20 continuous flashes at full power.
- Do not disassemble or attempt to repair this product yourself. There are high-voltage components inside that can produce a hazardous electric shock.
- Keep this product and its batteries out of reach of children.
- Use only the power sources specified in this manual.
- Always switch the flash off before changing the batteries.
- Always install AA batteries of the same type, brand, and age. Do not combine different types or brands, or old and new batteries. This could cause batteries to leak, overheat, or explode.

- Install batteries in the proper orientation, according to the indicator in the battery chamber. Installing batteries in the reverse orientation could cause them to leak, overheat, or explode.
- Do not use or store the VS-260S in flammable conditions (such as environments containing flammable gases or liquid chemicals). This could damage the flash, start a fire, or cause an electric shock.
- Do not clean the VS-260S with agents containing corrosive or flammable substances such as paint thinner, benzene, or nail polish remover.
- This product is not water resistant. Keep it away from rain, snow, humidity, and general moisture.
- Should the VS-260S get damaged, do not touch any exposed interior metal parts. If touched, they may generate an electric shock or cause a malfunction. Promptly remove the batteries, and take the product to an authorized service center for repair.
- If you detect excessive heat, smoke, or a burning smell coming from the flash, immediately stop operation and remove the batteries to prevent the product from igniting or melting. Take the product to an authorized service center for repair.
- Do not drop or otherwise cause a strong physical impact to the VS-260S, as this could cause a malfunction that may cause it to explode or ignite.
- Remove all batteries from the VS-260S before long-term storage in order to prevent the product from igniting or leaking corrosive liquids.
- Do not store or use this product at temperatures above 40°C / 104°F.

- Keep the metal contacts in the battery compartment clean and free of corrosion and dirt. Do not touch them with your fingers. Corrosive elements on the contacts can damage the VS-260S and prevent it from functioning properly. Contacts may be cleaned with isopropyl alcohol on a cotton swab.
- Dispose of used batteries properly. Never heat them or throw them into a fire, as this could cause the batteries to leak, overheat, or explode.

Installing Batteries

The VS-260S can be powered by two AA batteries of several types:

- Lithium (1.5V)
- Nickel-metal hydride (Ni-MH) (1.2V)
- Alkaline (1.5V)

Note: For the fastest recycle times and longest battery life, lithium and Ni-MH batteries are recommended.

To install batteries, make sure the VS-260S is turned off and follow these steps:

1. Press on the battery compartment cover and slide it in the direction of the arrow.
2. Insert batteries in the orientations indicated inside the compartment.
3. Replace the battery compartment cover by pressing and sliding it into place, in the opposite direction of the arrow on the cover.

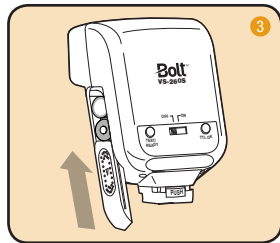
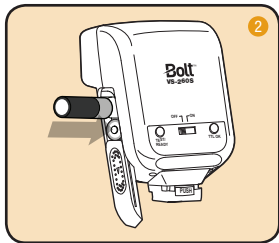
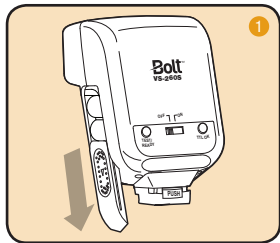

Important!

Replace both batteries at the same time. Do not mix battery types or brands, or use old and new batteries together.

Mounting the Flash

To mount the VS-260S on your camera, follow these steps:

1. Make sure that the flash is turned off.
2. Slide the mounting foot all the way into your camera's hot shoe.
3. The lock will automatically engage and hold the flash in place.

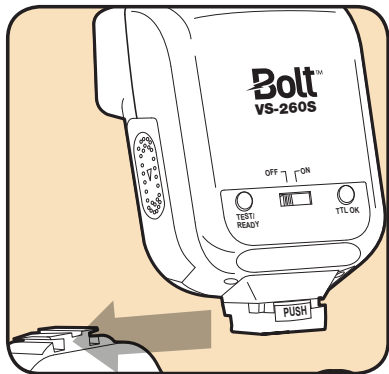

To dismount the flash from your camera, follow these steps:

1. Make sure that the flash is turned off.
2. Push the lock release button in while simultaneously sliding the mounting foot out of your camera's hot shoe.

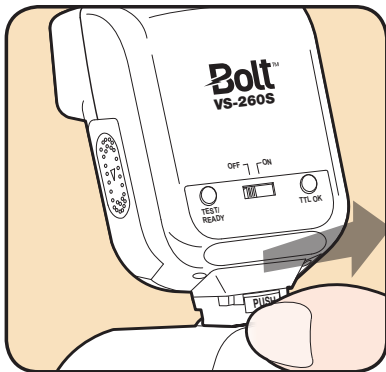

Turning on the Flash and Firing a Test

To turn the flash on, simply slide the power switch to the On position.

When the flash is ready to fire, the Ready light will glow red. If the flash is mounted on your camera, a flash icon will also appear in the camera's viewfinder when you press the shutter-release button halfway.

To fire a test flash, press the Ready light / Test button.

Automatic power-saving function: After 3 minutes of inactivity, the flash will automatically enter power-saving mode to conserve battery life. The Ready light will turn off. To reactivate the VS-260S, simply press the Ready light / Test button or your camera's shutter-release button. During long periods of inactivity, it is recommended that you use the power switch to turn the flash off completely.

Taking Photos

When the VS-260S is mounted on a compatible camera, it will set the appropriate flash level automatically, in conjunction with the camera's through-the-lens (TTL) metering system.

For information about your camera's flash sync speed range (the shutter speed range your camera will allow you to use when taking flash photos), consult your camera manual.

To take photographs with the flash, turn the flash and camera on and follow these steps:

1. Press the shutter-release button on your camera halfway to ensure that the camera is communicating with the flash. A flash icon will appear in the camera's viewfinder.
2. Press your camera's shutter-release button to take the picture. The OK light will glow green momentarily to indicate that the proper exposure was attained.

Using Red-Eye Reduction

The VS-260S supports red-eye reduction mode, which is set automatically by your camera. Consult your camera's manual for more information about this feature.

Using Flash Exposure Compensation

You can use flash exposure compensation to adjust the VS-260S's flash output incrementally, just as you would adjust exposure with the exposure compensation function on your camera.

To apply flash exposure compensation, press the flash exposure compensation button on your camera and adjust the flash exposure level up or down with your camera's controls.

The flash exposure compensation range and controls vary between different camera models. Consult your camera's manual for more information about this feature.

Using the Autofocus-Assist Light

Camera autofocus systems can have difficulty locking on a subject in dim light. When the ambient light level is low, the VS-260S will emit a red autofocus-assist beam when you press your camera's shutter-release button halfway to autofocus. The camera will then be able to autofocus by locking on the projected light.

Bouncing Your Flash

Using flash to directly illuminate a subject often creates harsh, unnatural, and unattractive shadows. To avoid this, the flash can be tilted up, allowing you to aim it at a large white or neutral-colored surface, such as a ceiling, a wall, or a reflector. The light will bounce off of the larger surface before striking your subject, providing softer, more natural illumination.

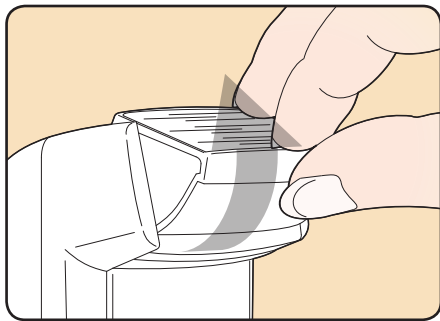

The VS-260S flash head can be tilted up at 45-, 60-, 75-, and 90-degree angles to the lens.

When bouncing your flash, you may need to adjust your exposure settings, since the level of light falling on your subject will be reduced. The farther away the bounce surface and your subject are, the more illumination will be reduced.

Tip: Bouncing your flash off of colored surfaces can create a color cast in your images. Bouncing off of a white or neutral-colored surface will not alter the color of the light, while bouncing off of a gold-toned surface can give portraits a warmer look. Other colors, while usually not desirable, can be used for creative effects.

Using Rear- or Second-Curtain Synchronization

When you photograph a moving subject with a slow (1/30 second or longer) shutter speed and a flash, the flash will freeze the moving subject and the long exposure will cause motion blur and light trails to appear in the image, especially in low light. This “slow-sync” flash technique, also referred to as “dragging the shutter,” can be applied in two different ways: The flash can be synchronized with the camera’s shutter release so that it fires at the beginning of the period when the shutter opens, or it can fire near the end of that period. The former is called “front-curtain” or “first-curtain” flash sync, and the latter is called “rear-curtain” or “second-curtain” sync. Front-curtain sync causes motion blur and light trails to appear in front of moving subjects, while rear-curtain sync makes them appear behind moving subjects. That means rear-curtain sync creates a more realistic impression of movement.

The VS-260S supports rear-curtain sync modes on cameras that offer the setting. Consult your camera’s manual to find out how to activate it. Use your camera’s manual or shutter-priority mode to control the amount of blurring and light trails you capture by varying the shutter speed.

Troubleshooting

Problem	Solution
The flash is stuck in the camera hot shoe.	Make sure that the mounting foot lock is released.
The flash is turned on but won't fire.	Make sure that fresh batteries are installed and in the proper orientation.
The edges of images look dark.	Your lens angle of view is wider than the flash angle of coverage. Use a lens with a longer focal length.
There's a whining sound coming from the flash.	This is normal and does not indicate a malfunction. When the flash becomes warm from continuous use, vibrations inside the unit may cause this sound. It will dissipate as the unit cools.

Customer Service

For customer service, please go to www.boltflashes.com.

Specifications

Type: On-camera TTL automatic flash

Compatible cameras: Sony cameras with TTL flash system support and a standard Sony hot shoe

Guide number (at ISO 100): 72 feet / 22 meters

Flash coverage: Equivalent to a 35mm lens on a 35mm-format camera

Flash duration: 1/2,000–1/40,000 second

Flash recycle time: 0.3–10 seconds

Power source: 2 AA lithium, Ni-MH, or alkaline batteries

Number of flashes with fresh batteries: Approx. 100

Bounce positions: 0°, 45°, 60°, 75°, 90°

Dimensions (W × H × D): 65 × 98 × 54 mm / 2.6 × 3.9 × 2 inches

Weight (without batteries): Approx. 4.6 ounces / 127 grams

One-Year Limited Warranty

This Bolt product is warranted to the original purchaser to be free from defects in materials and workmanship under normal consumer use for a period of one (1) year from the original purchase date or thirty (30) days after replacement, whichever occurs later. The warranty provider's responsibility with respect to this limited warranty shall be limited solely to repair or replacement, at the provider's discretion, of any product that fails during normal use of this product in its intended manner and in its intended environment. Inoperability of the product or part(s) shall be determined by the warranty provider. If the product has been discontinued, the warranty provider reserves the right to replace it with a model of equivalent quality and function.

This warranty does not cover damage or defect caused by misuse, neglect, accident, alteration, abuse, improper installation or maintenance. EXCEPT AS PROVIDED HEREIN, THE WARRANTY PROVIDER MAKES NEITHER ANY EXPRESS WARRANTIES NOR ANY IMPLIED WARRANTIES, INCLUDING BUT NOT LIMITED TO ANY IMPLIED WARRANTY OF MERCHANTABILITY OR FITNESS FOR A PARTICULAR PURPOSE. This warranty provides you with specific legal rights, and you may also have additional rights that vary from state to state.

To obtain warranty coverage, contact the Bolt Customer Service Department to obtain a return merchandise authorization ("RMA") number, and return the defective product to Bolt along with the RMA number and proof of purchase. Shipment of the defective product is at the purchaser's own risk and expense.

For more information or to arrange service, visit www.boltflashes.com or call Customer Service at 212-594-2353.



Product warranty provided by the Gradus Group.

www.gradusgroup.com

Bolt is a registered trademark of the Gradus Group. © 2015 Gradus Group LLC. All Rights Reserved.



Bolt™

www.boltflashes.com

GG3
97029A