



BG-C12

BATTERY GRIP

Designed for the
Canon 7D Mark II DSLR Camera

 VELLO™

USER'S MANUAL

Introduction

Thank you for choosing Vello and congratulations on your new BG-C12 battery grip purchase. Enjoy the many benefits that a battery grip offers, such as extended shooting time and more control and comfort when shooting in a vertical (portrait) orientation.

The Vello BG-C12 is compatible with the Canon 7D Mark II DSLR camera. The BG-C12 accepts two Canon LP-E6 rechargeable batteries, or six AA batteries (alkaline, Ni-MH, lithium, or nickel-manganese) can be used instead for added convenience. The BG-C12 is equipped with an alternate shutter-release button, AF area selection button, AF start button, AF point selection, AE lock/FE lock button, multi-controller button, multi-function button, and main dial for shooting in a vertical position.

Please read through this entire manual before using the BG-C12 battery grip.



Precautions

- 1.** The BG-C12 should be used only with compatible devices specified in this manual.
- 2.** Use only with batteries and battery holders recommended in this manual.
- 3.** Cover the power terminals with the contact cap when the BG-C12 is not in use. This prevents electrical shorts caused by metal objects touching the power terminals.
- 4.** When the battery holder is removed from the grip, remove the batteries or place the holder in a container to prevent electrical shorts caused by contact with other metal objects.
- 5.** If you notice smoke, an unusual smell or noise from the battery pack, discontinue use immediately. Remove the batteries and take the device to a Vello authorized reseller.
- 6.** Set the grip's control-lock switch to the locked position when not shooting vertically.
- 7.** The battery level may not display properly if batteries are inserted before mounting the grip.
- 8.** Remove batteries from the grip when not in use.
- 9.** Do not attempt to disassemble.
- 10.** Avoid water or extreme humidity and keep in a dry and cool place.
- 11.** Keep out of reach of children.
- 12.** All images are for illustrative purposes only.

Overview

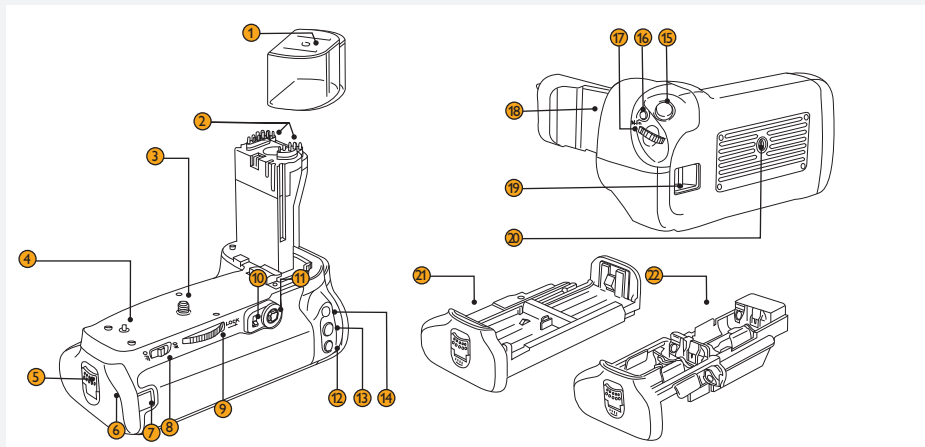

① Contact Cap

Protects grip contacts. Keep covered when the grip is not in use.

② Electrical Contacts

Communicates with the camera electronics.

③ Mounting Screw

Aligns with the camera's tripod socket.

④ Guide Pin

Helps align the camera to the grip.

⑤ Battery Tray Lever

Locks and unlocks the battery compartment door.

⑥ Battery Tray Compartment

Houses the battery tray.

⑦ DC Coupler Cord Mount

Groove for use with the Canon AC Power Adapter (ACK-E6).

⑧ Control-Lock Switch

To prevent accidental triggering, the control-lock switch (labeled OFF ON) disables or enables the BG-C12's controls. Your camera will continue to draw power from the BG-C12 when the switch is in the OFF position. Unlock prior to use by switching to the ON position. The control lock is not a power switch.

⑨ Attachment Wheel

Secures the grip to the camera.

⑩ AF Area Selection Button*

⑪ Multi-Controller Button*

⑫ AF Point Selection/Magnify Button*

⑬ AE Lock/FE Lock/Index/Reduce Button*

⑭ AF Start Button*

⑮ Shutter-Release Button*

⑯ Multi-Function (M-Fn) Button*

⑰ Main Dial*

⑱ Camera Battery Chamber Cover Holder

Stores the cover when the grip is mounted.

⑲ Hand Strap Mount

⑳ Tripod Socket

㉑ Battery Tray

Holds up to two Canon LP-E6 batteries.

㉒ AA Battery Tray

Holds up to six AA batteries.

** Performs the same function as on the camera.*

Attaching The Grip

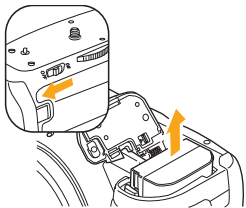

1. Ensure that the power is turned off on the camera and that the control-lock switch is set to OFF on the battery grip.
2. Remove the battery from the camera battery compartment.

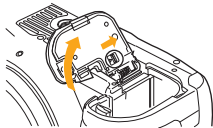

3. Open the camera battery chamber cover and remove as indicated above.

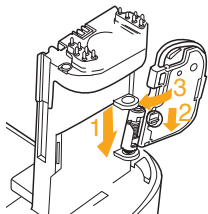

4. To prevent loss, place the battery chamber door into the BG-C12 battery door compartment. Align your camera's battery chamber door with the BG-C12 battery door compartment. Insert the door's bottom pin (1)

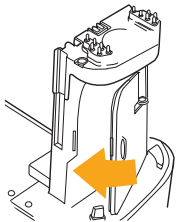

into the compartment. Pull the door's release latch down (2) and insert the top of the door into the compartment (3) as indicated by the arrows. Swing the door shut to lock it in place.

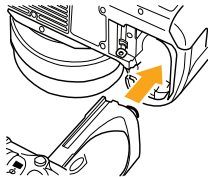

5. Remove the protective cap and connect the BG-C12 grip to the camera, while aligning the grip's mounting screw with the camera's tripod socket.

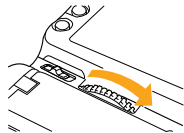

6. Rotate the attachment wheel in the direction shown by the arrow until it is firmly tightened.

When removing the grip, turn the camera power off, remove batteries, and replace protective contact cap.

Inserting Batteries

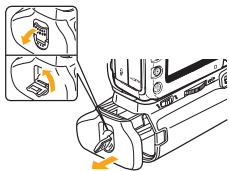

1. Ensure that the power is turned off on the camera and the grip. Use your fingernail to flip out the battery tray lever so you can rotate and pull as indicated above, and slide the battery tray out of the grip.

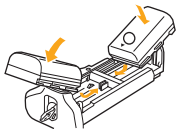

2. Canon LP-E6 batteries: Insert up to two batteries by placing them into either slot in the battery tray, while ensuring the correct orientation as shown on the tray.

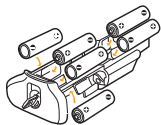

3. AA batteries: Place six new AA batteries of the same type into the AA battery holder as shown, while ensuring that they are in the correct orientation.

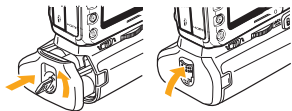

4. Rotate the battery tray lever counterclockwise and slide the battery tray all the way into the grip. Rotate the lever clockwise and push it back into place to lock the tray.



5. Switch the grip control lock to ON and then turn on the camera's power. Check the battery level in the control panel or viewfinder.

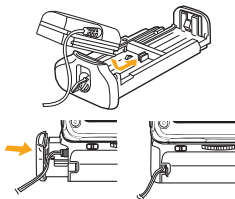

6. Household Power Outlet: The Canon ACK-E6 AC Power Adapter Kit (sold separately) can be connected to the grip. Place the DC coupler through the small groove on the back of the grip. Ensure that the cord doesn't get pinched by the battery holder.

Make sure the camera's power switch is in the Off position before mounting the DC coupler.

Specifications

Power Source	<ol style="list-style-type: none">1. One or two Canon LP-E6 rechargeable batteries2. Six AA/LR6 alkaline batteries3. Works with the Canon AC Adapter Kit ACK-E6 (sold separately)
Operating Temperature	32°F–104°F (0°C–40°C)
Dimensions (W × H × D)	5.9" × 4.5" × 3.4" (15.3 × 11.3 × 8.6 cm)
Weight	12 oz. (340 g) (without batteries)

Specifications and design are subject to change without notice.

AA batteries do not provide as much shooting time as LP-E6 rechargeable batteries. Performance of AA batteries may also be dependent on brand and storage conditions. AA batteries may not function under 68°F (20°C).

Please note: When using the AA battery tray, the battery indicator will only work with Ni-MH batteries. This product is not compatible with Duracell® brand alkaline batteries.

When the camera's internal GPS is enabled, the camera will continue to draw power from the battery, even when the camera is turned off.

ONE-YEAR LIMITED WARRANTY

This VELLO product is warranted to the original purchaser to be free from defects in materials and workmanship under normal consumer use for a period of one (1) year from the original purchase date or thirty (30) days after replacement, whichever occurs later. The warranty provider's responsibility with respect to this limited warranty shall be limited solely to repair or replacement, at the provider's discretion, of any product that fails during normal use of this product in its intended manner and in its intended environment. Inoperability of the product or part(s) shall be determined by the warranty provider. If the product has been discontinued, the warranty provider reserves the right to replace it with a model of equivalent quality and function.

This warranty does not cover damage or defect caused by misuse, neglect, accident, alteration, abuse, improper installation or maintenance. EXCEPT AS PROVIDED HEREIN, THE WARRANTY PROVIDER MAKES NEITHER ANY EXPRESS WARRANTIES NOR ANY IMPLIED WARRANTIES, INCLUDING BUT NOT LIMITED TO ANY IMPLIED WARRANTY OF MERCHANTABILITY OR FITNESS FOR A PARTICULAR PURPOSE. This warranty provides you with specific legal rights, and you may also have additional rights that vary from state to state.

To obtain warranty coverage, contact the Vello Customer Service Department to obtain a return merchandise authorization ("RMA") number, and return the defective product to Vello along with the RMA number and proof of purchase. Shipment of the defective product is at the purchaser's own risk and expense.

For more information or to arrange service, visit www.vellogear.com or call Customer Service at 212-594-2353.

Product warranty provided by the Gradus Group.

www.gradusgroup.com

VELLO is a registered trademark of the Gradus Group. © 2015 Gradus Group LLC. All Rights Reserved.





© Copyright 2015 Gradus Group LLC
All other trademarks are the property of their respective owners
GG2