

P100HD Specifications

CODE: 1340 JAN: 4560353280666

Power source	DC12V (AC adapter: AC100 to 240V)
Power consumption	26.4W
Dimensions	W 457 x D 519 x H 587 [mm] (Set up) W 457 x D 567 x H 137 [mm] (Folded)
Weight	Approx. 17.4 lbs (7.9kg) (Main unit only)
Input selection	Main camera / External x4
Output terminal	RGB Mini Dsub 15P connector, female x1 HDMI Type A x1 Line φ3.5mm stereo mini jack x2
Input terminal	RGB Mini Dsub 15P connector, female x2 HDMI Type A x2 Mic In/Line In terminal (shared) φ3.5mm stereo mini jack x1 Line φ3.5mm stereo mini jack x2
Ext. control	USB device (2.0 compliant) Type mini B receptacle x1 RS-232C Dsub9P connector male x1 Ethernet RJ45 connector x1
Memory interface	SD card slot x1 USB host (2.0 compliant) Type A receptacle x1
Lens	f = 4.9mm ~ 78.4mm (16x zoom) F2.7
Frame rate	30fps
Shooting area	1080p : Max. 400mmx223mm, Min. 27mm15mm 720p : Max. 400mmx223mm, Min. 27mm15mm SXGA : Max. 400mmx320mm, Min. 27mm22mm WXGA : Max. 400mmx248mm, Min. 27mm17mm XGA : Max. 400mmx299mm, Min. 27mm20mm
Limit of focus adjustment	with Close-up lens TELE: 250mm ~ 440mm from Close-up lens WIDE: 90mm ~ 440mm from Close-up lens without Close-up lens TELE: 500mm ~ ∞ from surface of Zoom lens WIDE: 100mm ~ ∞ from surface of Zoom lens
Optical zoom	16 x
Digital zoom	8 x
Focus	Auto / Manual / Zoom Sync
Image pick-up device	1/2.8" CMOS
Total pixels	Horizontal 2144, Vertical 1588
Effective pixels	Horizontal 1920, Vertical 1536
Sync. system	Internal
Resolution	Analog RGB Horizontal 800TV lines or more, Vertical 800TV lines or more
Analog RGB output	Analog RGB 0.7V (p-p) 75 Ω unbalanced Sync. signal SXGA : positive polarity WXGA : horizontal negative polarity, vertical positive polarity XGA : negative polarity 1080p : positive polarity 720p : positive polarity SXGA : 1280 x 1024 @ 60Hz Horizontal frequency : 63.981kHz Vertical frequency : 60.020Hz WXGA : 1280 x 800 @ 60Hz Horizontal frequency : 49.306kHz Vertical frequency : 59.910Hz XGA : 1024 x 768 @ 60Hz Horizontal frequency : 48.363kHz Vertical frequency : 60.004Hz 1080p : 1920 x 1080 @ 60Hz Horizontal frequency : 67.50kHz Vertical frequency : 60.00Hz 720p : 1280 x 720 @ 60Hz Horizontal frequency : 45.00kHz Vertical frequency : 60.00Hz
HDMI output	Image output : 1080p 720p Audio output : PCM 44.1kHz sampling
White balance	Auto / One-Push / Manual
Brightness control	Auto (with level adjustment) / Manual
Positive / Negative conversion	Provided
Color / B&W selection	Provided
Image rotation	0° / 180°
Image mode	Text1 / Text2 / Text3 / Graphics1 / Graphics2
Gamma setting	Possible (only for Graphics1 mode)
Edge effect	Provided (only for Graphics1 mode)
Pause	Provided
Still image save	Provided
Live image save	Provided
Flicker correction	60Hz / 50Hz
Upper lighting unit, Base lighting unit	White LED
Accessories	IR Wireless Remote Control, strap, RGB cable, USB cable, AC adapter, Power cord, AAA batteries, Image Mate instruction manual CD-ROM, LAN cable, ferrite core (for MIC IN cable and AUDIO OUT cable), important safeguards, Image Mate installation manual, Warranty card

Network

Interface	10Base-T/100Base-TX (RJ-45)
Supporting protocol	IP (IPv4), ARP, ICMP, TCP, HTTP
Recommended browser	Internet Explorer 6.0 or later (Windows) Safari 5.0 or later (Mac)
Supporting OS	Windows XP (SP3) / Vista (SP2) / 7 (SP1) / 8 Mac OS X 10.6.8 / 10.7.5 / 10.8.x
Java	JRE (Java Runtime Environment) 1.6.0_29 or later
Connection port number	HTTP : 80
Language	Japanese / English
Image format	Motion-JPEG
Image size	1080p Horizontal 1920, Vertical 1080 720p Horizontal 1280, Vertical 720 SXGA Horizontal 1280, Vertical 1024 WXGA Horizontal 1280, Vertical 800 XGA Horizontal 1024, Vertical 768
Frame rate	Max. approx. 5fps
Simultaneous connection at LIVE view	5 clients
Still image format	JPEG
Remote controllable functions	ZOOM, LAMP, BRIGHTNESS, FOCUS, TEXT/GRAPHICS, IMAGE ROTATION, POSI/NEGA, COLOR/B&W etc.

Design and specifications are subject to change without prior notice. The images in this brochure are simulated.
"ELMO" is a trademark of ELMO COMPANY, LIMITED. SD logo is a trademark.
Other brand names and product names may be trademarks or registered trademarks of their respective owners.

Profile

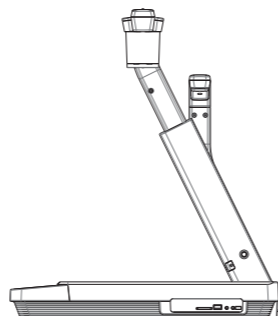
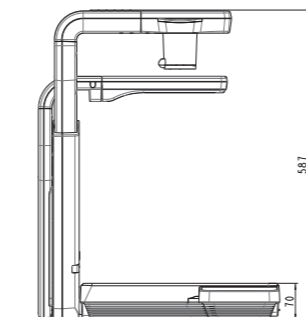
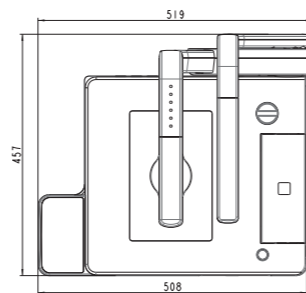

Rear Panel/ Side Panel



ELMO

Greatness through the Power of Expression



VISUAL PRESENTER
P100HD

ELMO's Helping to Provide a Greener Future for Our Children

This ELMO product complies with RoHS Directive 2002/95/EC (Restriction of the use of certain Hazardous Substances in electronic equipment). This compliance helps to ensure a healthier and greener environment for all our children.



ELMO CO., LTD. is one of the sponsors for Japan Committee Vaccines for the World's Children (JCV).

JCV operates under basic guidelines and objectives of the Children's Vaccine Initiative (CVI) founded in 1990 by UNICEF, WHO, UNDP, the Rockefeller Foundation, and the World Bank.

ISO 9001
ISO 14001

ELMO CO., LTD.

6-14, Meizen-cho, Mizuho-ku
Nagoya, 467-8567, Japan
E-mail : overseassales@elmo.co.jp

ELMO (Beijing) Co., Ltd.

Room 1002, 10F, Build 5, Wanda Plaza,
No. 93, Jianguo Road, Chaoyang District,
Beijing 100022, P.R. China
Tel. +86 10 5960 3685
Fax. +86 10 5960 3424

Distributed by

ELMO USA Corp.

Headquarters
1478 Old Country Road
Plainview, NY 11803 U.S.A.
Tel. +1 (516) 501 1400
Fax. +1 (516) 501 0429
E-mail : elmo@elmousa.com
Web : <http://www.elmousa.com>

West Coast Branch

5676 Corporate Avenue
Cypress, CA 90630 U.S.A.
Tel. +1 (714) 828 8457
Fax. +1 (714) 828 8429

ELMO Europe SAS

Headquarters
Immeuble Elysées La Défense,
7C Place du Dôme,
92056 Paris La Défense, France
Tel. +33 (0)1 73 02 67 06
Fax. +33 (0)1 73 02 67 10
E-mail : info@elmoeurope.fr
Web : <http://www.elmoeurope.fr>

German Branch

Hansaallee 201, Haus 1
40549 Düsseldorf
Germany
Tel. +49 (0) 211 544756 40
Fax. +49 (0) 211 544756 60
E-mail : info@elmo-germany.de
Web : <http://www.elmo-germany.de>



This brochure is printed on recycled paper with environmentally friendly vegetable oil-based ink.

Printed in Japan (H) 04/2014

Vivid expression enhances the understanding of the audience. The P100HD is fully integrated with an LCD Touch Panel, ensuring easy operation in every situation.



In a lecture or a seminar

Displaying enlarged images of your teaching materials is the most popular application of the document camera.



In a video conference

Conduct effective meetings by displaying documents or real objects to participants face-to-face.



In an internal meeting

Display new product samples, confidential or restricted documents.



For introducing products and demonstrations

Demonstrate how to use a keyboard, a smartphone or a tablet by showing the finger movements.

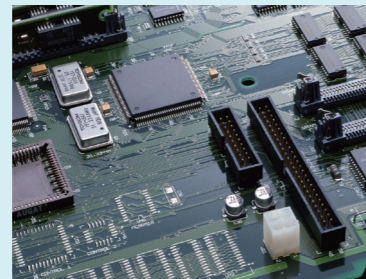

For inspection or quality control in production lines

Display enlarged images of small parts, detailed wiring or fine print on a circuit board.



As a useful rental item for events and conferences

The document camera is a favorite item for presenters at seminars and conferences.

Network Server Function

By connecting the P100HD to a computer using a LAN cable, you can remotely control the P100HD and view or capture the live image via web browser.

Save Presentations on External Memory

Both video files (mp4) and still images (JPEG) can be saved on a USB flash drive or SD memory card for future use. The saved image files can be displayed as individual files or as slideshow without using a computer or other hardware. The audio from the built-in microphone and the external audio input can be output from the audio line output and the HDMI output.

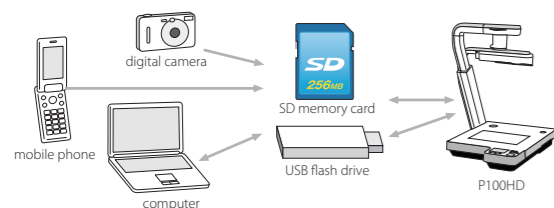

Built-in Touch Panel LCD monitor

P100HD's Touch Panel LCD monitor is intuitive and easy to use. It allows you to straighten out the position of your materials without turning around to look at the image on the screen behind you.



Simple Operation with Wireless Remote Control

The uniquely designed remote control allows users to control the P100HD from almost anywhere in the room.



3.4 Megapixel CMOS Image Sensor & HDMI

The P100HD's megapixel image sensor captures everything from fine print to three-dimensional objects in 1080p full HD.



Powerful Optical & Digital Zoom

16X Optical zoom x 8X Digital zoom = 128X Total zoom

The powerful Optical & Digital zoom ensure that all materials, such as detailed craftsmanship or artwork, tiny components on circuit boards, or small print in books are clearly displayed when enlarged.

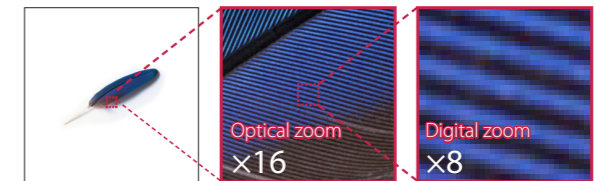

Smooth Movement with Audio at 30fps

The P100HD can capture and reproduce movement with audio at 30fps (frames per second) for the display of truly smooth, natural-looking motion.

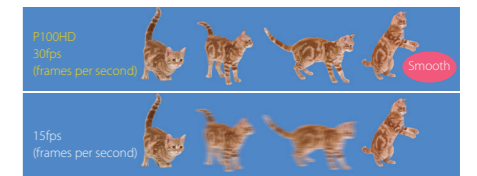

Flexible System Configuration

The P100HD is equipped with a built-in switcher function. It can handle different image signals such as RGB and HDMI and control multiple devices. By using the ELMO CRA-1 Wireless Tablet, you can annotate on live images captured by the P100HD while the image is displayed on a large screen. The CRA-1's wireless adapter can be plugged directly into the P100HD, allowing direct annotation on live images from anywhere in the room without having to use a computer.

