



Armor Case

INSTRUCTION MANUAL

Please read this manual carefully before using this product and keep it for future reference.

IMPORTANT SAFEGUARDS

Please read all precautions and warnings before starting to use. The information is provided to ensure proper operation of this product and will prevent you or others from personal injury or loss of assets. Review the following symbols so that you understand them before reading the rest of the manual. Please read carefully and keep the manual in a safe place for future reference.

| | |
|---|---|
|  DANGER | Ignoring the warning and operating the system incorrectly subjects the user to an extremely high risk of injury or death. |
|  WARNING | Ignoring the warning and operating the system incorrectly subjects the user to possible risk of injury or death. |
|  CAUTION | Ignoring the warning and operating the system incorrectly subjects the user to risk of injury or loss of assets. |

 **DANGER**

Verify the following before you use this product.

- There is no damage in the parts. • The screws are firmly tightened.
- The QBic MS-1 is firmly attached to the case.
- The cover of the case is properly closed. • The case is firmly installed.

When using this product or the QBic MS-1 attaching to your body or helmet while driving a car, motorbike or bicycle, pay attention to the traffic and road surface conditions around you to prevent any accident.

- Never operate the QBic MS-1 while driving a car, motorbike or bicycle.
- It could cause injury when the QBic MS-1 accidentally hits your body in a collision or a fall.

Do not attach this product and the QBic MS-1 outside a car, motorbike or bicycle. • It may be prohibited by law to attach an object other than specified outside a car, motorbike or bicycle. If you have a permit and intend to attach this product and the QBic MS-1 outside a car, motorbike or bicycle, make sure to attach them firmly so that they won't come off during driving.

 **WARNING**

Keep this product, package or packing materials out of baby's reach.

- They could choke or injure a baby if swallowed. Contact a doctor immediately if this happens.

Do not install this product in areas where salt erosion or corrosive gas is produced.

- The product will be damaged and it may cause the QBic MS-1 to drop accidentally, leading to injury or malfunction.

Do not install this product to insecure places.

- It may cause the QBic MS-1 to drop accidentally, leading to injury or malfunction.

Do not attach objects other than specified to the case.

- The object may drop due to insufficient support, leading to injury or malfunction.

Be careful not to sandwich your fingers or foreign objects when opening or closing the cover or lever of the case. It may cause injury or malfunction.

 **CAUTION**

Do not clean this product with strong solvents such as thinner and benzene.

- This may damage the quality of plastic or rubber material.
- Clean this product only with a dry, soft cloth. In case of heavy dirt, wash lightly with fresh water. Then wipe it with a dry, soft cloth.

Do not use this product in hot place or under strong sunlight for a long period of time.

- Excessive heat may damage the quality of this product or change its shape, causing the QBic MS-1 to drop due to insufficient support, leading to injury or malfunction.

Do not move this product with excessive force when screws are tightened.

- It may cause the screw to become loose or damage the screw.

Depending on the shape of the place, this product may not be installed.

- The QBic MS-1 inside the case may be damaged when an excessive impact is applied to the case.

Do not swing around this product after being installed.

- It may cause the case with the QBic MS-1 to be detached from the holder.

Do not install this product to wet place.

- It may weaken the attachment of the double-faced tape causing the product to easily detach itself.

Use this product under the following environmental conditions:

- Usage under water: less than 15m in depth (2.5bar)
- Continuous use: less than 20min.
- Water temperature: 0°C to 40°C

Otherwise, it may cause water leak or malfunction.

The rubber packing inside the rear cover plays an important role for keeping waterproof performance of the case.

- We do not guarantee the waterproof performance of the case in every situation. ELMO is not responsible for any damage to the QBic MS-1 (sold separately) or any incidents caused by the use of the product in conditions outside the specification or mishandling by the user.

• The waterproof performance is not guaranteed if the product is subjected to an impact or the rubber packing of the product is deteriorated or damaged.

Waterproof function of the product is for sea water and fresh water.

If the product is splashed by substances as detergent, soap, hot spring water, bath agent, sunscreen lotion or chemical liquid, wipe off immediately.

In order to maintain the waterproof performance, observe the following precautions when you use the product under water.

- Use the product in a water depth of 15 m (2.5bar) or less, in a water temperature range of 0°C to 40°C.
- Do not use the product continuously under water for longer than 20 minutes.
- Make sure that the rear cover hook is securely locked before entering the water.
- Do not open or close the rear cover hook or the rear cover while under water.
- Do not dive into water holding the product. Do not apply impact to the product while under water.

When the product is used under water (sea or river), immediately rinse with clean water, wipe off the water droplets with a soft, dry cloth.

Do not open or close the rear cover in dusty locations.

Otherwise, foreign objects such as sand may adhere to the rubber packing, causing degradation of the performance of the product such as waterproof performance, leading to malfunction.

If sand or dust is adhered to the grooves on the rubber packing, wipe it off carefully with a clean, dry, soft cloth.

If the case is subjected to an impact or the performance of the rubber packing of the case is deteriorated, stop the using.

The performance of the rubber packing of the case will deteriorate over time.

WHAT'S IN THE BOX

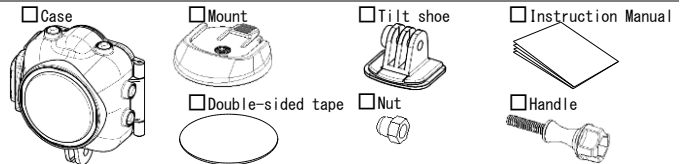

HOW TO USE

1. Assemble the case.

- ① Assemble the case and the tilt shoe. Align the holes.
- ② Insert the nut and the handle into the hole. Fix it firmly.

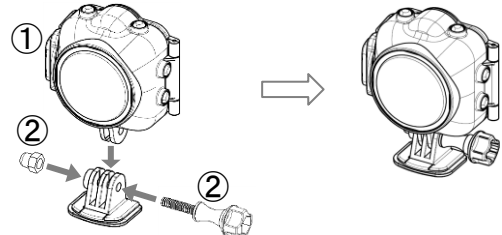

2. Attach the QBic MS-1 (sold separately) to the case.

- ① While pressing the lock up, pull the lever and take off the hook to open the rear cover.
- ② Push the QBic MS-1 fully into the case.
- ③ Close the rear cover. Hook the tabs and press the lever to firmly close the cover.

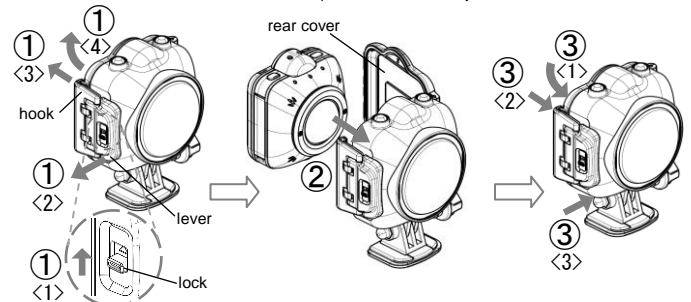
 **CAUTION**

- Make sure that the lever is fully pressed and the cover is firmly closed. Otherwise, the cover may accidentally open, leading to water leakage or malfunction.

3. Attach the mount.

- When using double-sided tape

Attach the mount using the supplied double-sided tape. Make sure to wipe off water, oil or dirt on the attachment surface in advance.

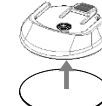
 **CAUTION**

- Do not attach to the rough surface such as wood, skin or cloth.
- There may be residue left on the surface when you try to peel the tape away.
- Do not reuse the tape.

- When using a commercially available screw

Using a "1/4-20UNC" screw available in the market, you can attach to a standard tripod and the like.

 **CAUTION**

- Make sure that the screw does not come out of the mount.

4. Attach the case to the mount.

Attach the case to the fixed mount.

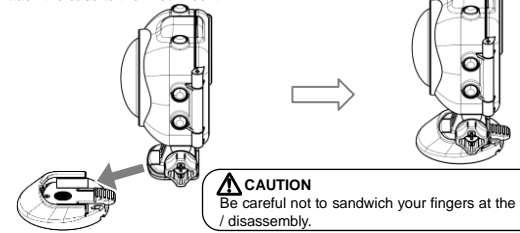
 **CAUTION**

- Be careful not to sandwich your fingers at the time of installation / disassembly.

5. Remove the case from the mount.

- ① Press down the lock.
- ② Holding the lock down, slide the case backward to remove.

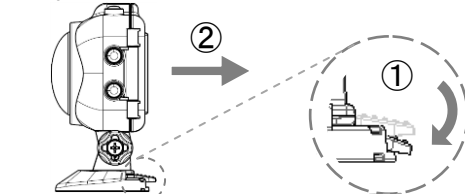

*Please refer to QBic instruction manual for shooting information.

Installable device: QBic MS-1

※Do not attach objects other than specified to this products.

PLEASE NOTE:

- Contents of this manual may be subject to change without notice. Please check the latest version from the following QBic MS-1 website. <http://www.elmqbic.com/>
- We shall not be liable for any direct, indirect, punitive, incidental, special, consequential or exemplary damages, including but not limited to loss of profits or claims by third party, resulting from your use of this product.

•Contact Us

Please refer to the above-mentioned QBic Website.