



msi[®]

User's Manual
NOTEBOOK

Content

Copyright Notice	1-4
Trademarks	1-4
Revision History	1-4
FCC-B Radio Frequency Interference Statement	1-5
FCC Conditions.....	1-5
CE Conformity.....	1-5
Battery Regulations	1-6
WEEE Statement.....	1-6
Chemical Substances Information.....	1-6
RoHS Statement.....	1-7
Japan JIS C 0950 Material Declaration	1-7
India RoHS.....	1-7
Turkey EEE regulation	1-7
Ukraine restriction of hazardous substances.....	1-7
Vietnam RoHS.....	1-7
Upgrade and Warranty	1-8
Acquisition of Replaceable Parts	1-8
Safety Instructions	1-9
MSI Highlights	1-11

Introductions.....2-1

Unpacking.....	2-2
Product Overview	2-3
Top-open View	2-3
Front Side View	2-6
Right Side View	2-7
Left Side View.....	2-8
Rear Side View.....	2-9
Bottom Side View.....	2-10
How to Use the Keyboard	2-11
Windows Key	2-11
Quick Launch Keys	2-12
Disable or Enable Touchpad	2-13
Switch Display	2-13
Use Multiple Monitors	2-13
Adjust the Brightness Level of the Display	2-13

Adjust the Sound Level of the Speaker	2-14
Adjust the Brightness Level of the Keyboard Backlight LED (optional)	2-14
Application: True Color (optional)	2-15
Video: How to Use [Fn] Buttons	2-15
Specifications	2-16

How to Get Started3-1

Begin to Use the Notebook	3-2
How to Use the Notebook Comfortably	3-4
How to Manage Power Supply	3-5
AC/DC Adapter	3-5
Battery	3-5
How to Set Up a Power Plan in Windows 10	3-7
Choose or Customize a Power Plan	3-7
Create Your Own Power Plan	3-10
How to Use the Touchpad	3-12
About HDD and SSD	3-14
About M.2 SSD Slot	3-14
How to Connect the Internet	3-15
Wireless LAN	3-15
Wired LAN	3-17
How to Set Up Bluetooth Connection	3-22
Activating Bluetooth Connection	3-22
How to Connect External Devices	3-25
Video: How to Use RAID Function	3-26
How to Select Boot Mode in BIOS	3-27
Video: How to Restore Windows 10 Operating System on MSI Notebooks	3-28
Video: How to Use MSI One Touch Install	3-29



Copyright Notice

The material in this document is the intellectual property of Micro-Star International Co., Ltd. We take every care in the preparation of this document, but no guarantee is given as to the correctness of its contents. Our products are under continual improvement and we reserve the right to make changes without notice.

Trademarks

All trademarks are the properties of their respective owners.

Revision History

- ▶ Version: 2.0
- ▶ Date: 08, 2017

FCC-B Radio Frequency Interference Statement

This equipment has been tested and found to comply with the limits for a Class B digital device, pursuant to part 15 of the FCC rules. These limits are designed to provide reasonable protection against harmful interference in a residential installation. This equipment generates, uses and radiates radio frequency energy, and, if not installed and used in accordance with the instructions, may cause harmful interference to radio communications. However, there is no guarantee that interference will not occur in a particular installation. If this equipment does cause harmful interference to radio or television reception, which can be determined by turning the equipment off and on, the user is encouraged to try to correct the interference by one or more of the following measures:

- ▶ Reorient or relocate the receiving antenna.
- ▶ Increase the separation between the equipment and receiver.
- ▶ Connect the equipment into an outlet on a circuit different from that to which the receiver is connected.

NOTE

- ▶ The changes or modifications not expressly approved by the party responsible for compliance could void the user's authority to operate the equipment.
- ▶ Shield interface cables and AC power cord, if any, must be used in order to comply with the emission limits.

FCC Conditions

This device complies with part 15 of the FCC Rules. Operation is subject to the following two conditions:

- ▶ This device may not cause harmful interference.
- ▶ This device must accept any interference received, including interference that may cause undesired operation.

CE Conformity



This device is in compliance with the essential safety requirements and other relevant provisions set out in the European Directive.

Battery Regulations



European Union: Batteries, battery packs, and accumulators should not be disposed of as unsorted household waste. Please use the public collection system to return, recycle, or treat them in compliance with the local regulations.



廢電池請回收

Taiwan: For better environmental protection, waste batteries should be collected separately for recycling or special disposal.

California, USA: The button cell battery may contain perchlorate material and requires special handling when recycled or disposed of in California.

For further information please visit: <http://www.dtsc.ca.gov/hazardouswaste/perchlorate/>

Safety Guideline for Using Lithium Battery

Danger of explosion if battery is incorrectly replaced. Replace only with the same or equivalent type recommended by the equipment manufacturer. Discard used batteries according to manufacturer's instructions.

WEEE Statement



European Union: Under the European Union ("EU") Directive on Waste Electrical and Electronic Equipment, Directive 2002/96/EC, which takes effect on August 13, 2005, products of "electrical and electronic equipment" cannot be discarded as municipal waste anymore and manufacturers of covered electronic equipment will be obligated to take back such products at the end of their useful life.

Chemical Substances Information

In compliance with chemical substances regulations, such as the EU REACH Regulation (Regulation EC No. 1907/2006 of the European Parliament and the Council), MSI provides the information of chemical substances in products at:

http://www.msi.com/html/popup/csr/evmtprrt_pcm.html

RoHS Statement

Japan JIS C 0950 Material Declaration

A Japanese regulatory requirement, defined by specification JIS C 0950, mandates that manufacturers provide material declarations for certain categories of electronic products offered for sale after July 1, 2006.

http://www.msi.com/html/popup/csr/cemm_jp.html

http://tw.msi.com/html/popup/csr_tw/cemm_jp.html

India RoHS

This product complies with the "India E-waste (Management and Handling) Rule 2011" and prohibits use of lead, mercury, hexavalent chromium, polybrominated biphenyls or polybrominated diphenyl ethers in concentrations exceeding 0.1 weight % and 0.01 weight % for cadmium, except for the exemptions set in Schedule 2 of the Rule.

Turkey EEE regulation

Conforms to the EEE Regulations of the Republic Of Turkey.

Ukraine restriction of hazardous substances

The equipment complies with requirements of the Technical Regulation, approved by the Resolution of Cabinet of Ministry of Ukraine as of December 3, 2008 № 1057, in terms of restrictions for the use of certain dangerous substances in electrical and electronic equipment.

Vietnam RoHS

As from December 1, 2012, all products manufactured by MSI comply with Circular 30/2011/TT-BCT temporarily regulating the permitted limits for a number of hazardous substances in electronic and electric products.



Upgrade and Warranty

Please note that certain components, such as memory modules, HDD, SSD, ODD, and Bluetooth/WiFi combo card, etc., preinstalled in the product may be upgradable or replaceable by user's request depending on the models users purchased.

For any further information on the product users purchased, please contact the local dealer. Do not attempt to upgrade or replace any component of the product if users do not understand the component location or how to assembly/disassembly, since it may cause the product damaged. It is recommended that user contact the authorized dealer or service center for product service.

Acquisition of Replaceable Parts

Please be noticed that the acquisition of replaceable parts (or compatible ones) of the product users purchased in certain countries or territories may be fulfilled by the manufacturer within 5 years at most since the product has been discontinued, depending on the official regulations declared at the time. Please contact the manufacturer via <http://www.msi.com/support/> for the detailed information about the acquisition of spare parts.

Safety Instructions



Read the safety instructions carefully and thoroughly. All cautions and warnings on the equipment or user's manual should be noted.



Keep the notebook away from humidity and high temperature.



Lay the notebook on a stable surface before setting it up.



Do not cover the ventilators of the notebook to prevent the notebook from overheating.



- Do not leave the notebook in an unconditioned environment with a storage temperature above 60°C (140°F) or below 0°C (32°F), which may damage the notebook.
- This notebook should be operated under maximum ambient temperature of 35°C (95°F).



Place the power cord in a way that people are unlikely to step on it. Do not place anything on top of the power cord.



Always keep the strong magnetic or electrical objects away from the notebook.



- Never pour liquid into the opening that could damage the equipment or cause an electrical shock.
- Never use any chemical substance to wipe the surface of this equipment, such as keyboard, touchpad, and notebook case.



If any of the following situations arises, get the equipment checked by a service personnel:

- The power cord or plug is damaged.
- Liquid has penetrated into the equipment.
- The equipment has been exposed to moisture.
- The equipment has not worked well or you can not get it work according to User's Manual.
- The equipment was dropped and damaged.
- The equipment has obvious signs of breakage.

Green Product Features

- Reduced energy consumption during use and stand-by
- Limited use of substances harmful to the environment and health
- Easily dismantled and recycled
- Reduced use of natural resources by encouraging recycling
- Extended product lifetime through easy upgrades
- Reduced solid waste production through take-back policy



Environmental Policy

- The product has been designed to enable proper reuse of parts and recycling and should not be thrown away at its end of life.
 - Users should contact the local authorized point of collection for recycling and disposing of their end-of-life products.
 - Visit the MSI website and locate a nearby distributor for further recycling information.
 - Users may also reach us at gpcontdev@msi.com for information regarding proper disposal, take-back, recycling, and disassembly of MSI products.
-

MSI Highlights

Explore more exclusive features of MSI notebooks for all series, please visit: <http://www.msi.com> and <https://www.youtube.com/user/MSI>



How to use SteelSeries Engine 3 on MSI notebooks

MSI collaborates with SteelSeries to develop an exclusive SteelSeries Engine 3 in gaming notebooks. SteelSeries Engine 3 is the Apps to combine frequently used functions for gamers in multiple devices management.



MSI GAMING Notebook is the first gaming Notebook featuring XSplit Gamecaster live stream app!

MSI gaming notebook features XSplit Gamecaster, the easiest live streaming and recording solution for gamers.



Sound by Dynaudio on MSI Gaming Notebooks

MSI partners with Dynaudio, the Danish sound specialists, in its gaming notebooks to present you an authentic fidelity audio performance.



Color Your Life with True Color

MSI has partnered with Portrait Displays, Inc. in developing more accurate, high precision panel quality. MSI True Color Technology guarantees that each panel in a MSI notebook comes with the finest precision in color.



Tutorial: How to use Nahimic

Discover how to use Nahimic and its three features: Nahimic Audio Effects, Microphone Effects and HD Audio recorder.

Introductions

User's Manual
NOTEBOOK

Congratulations on becoming an user of this notebook, the finely designed notebook. You will have a delightful and professional experience in using this exquisite notebook. We are proud to tell users that this notebook is thoroughly tested and certified by our reputation for unsurpassed dependability and customer satisfaction.

Unpacking

First, unpack the shipping carton and check all items carefully. If any item contained is damaged or missing, please contact your local dealer immediately. Also, keep the box and packing materials in case you need to ship the unit in the future. The package should contain the following items:

- ▶ Notebook
- ▶ Quick Start Guide
- ▶ AC/DC adapter and AC power cord
- ▶ Optional second AC/DC adapter and AC power cord
- ▶ Optional DualPower Box
- ▶ Optional carry bag
- ▶ Optional all-in-one application disk, containing the full version of user's manual, drivers, utilities, and so on.

Product Overview

This section provides the description of basic aspects of the notebook. It will help you to know more about the appearance of this notebook before using it. Please be aware that the figures shown here are for reference only.

Top-open View

The figure of top-open view and description shown below will lead you to browse the main operating area of your notebook.

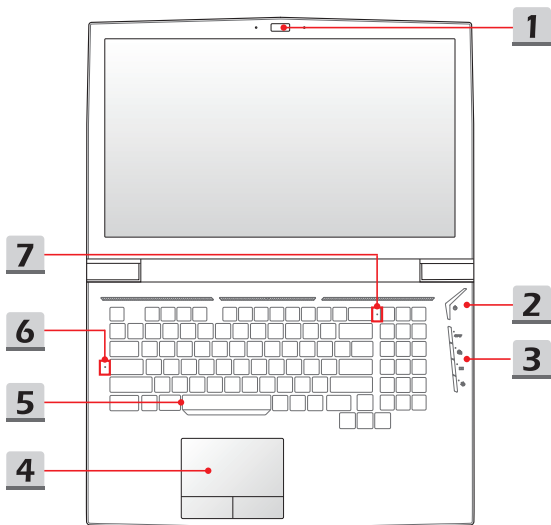

1. Webcam/ Webcam LED/ Internal Microphone

- This built-in webcam can be used for picture taking, video recording or conferencing, and so on.
- Webcam LED indicator, next to the webcam, glows when webcam function is activated; LED goes out when this function is turned off.
- The built-in microphone and its function is the same with microphone.

2. Power Button / Power LED



Power

Power Button

- Use this button to turn the notebook power ON and OFF.
- Use this button to awake the notebook from the sleep state.

Power LED

- LED glows when the notebook power is turned on.
 - LED flashes when the notebook goes to the sleep state.
 - LED goes off when the notebook is turned off.
-

3. Quick Launch Buttons

Use the quick launch buttons to activate the specific applications or tools. The following quick launch buttons will only be functional in the operating system with the SCM application installed. Find the SCM exe file in the optional all-in-one disk that comes with the package or download it from MSI's website for easy and convenient operation.



Graphics Switch

- Use this button to select either discrete GPU mode or UMA GPU mode.
 - Button LED glows when the discrete GPU mode is selected.
-



Cooler Boost

- Use this button to maximize the fan speed to cool down the overall temperature of the notebook.
 - Button LED glows when the fan speed is set to maximum level; LED goes off when AUTO mode is selected.
-



XSplit
Gamecaster

- Use this button to activate video recording and real-time online broadcasting while playing games.
 - Button LED glows when this function is activated.
 - If XSplit Gamecaster is not installed, this button will be used to launch the User Defined application.
-



- This notebook may be pre-installed a unique keyboard manager application, SSE (SteelSeries Engine). With this application, users will be able to own several combinations of keyboard hot keys defined separately for specific occasions.
 - Use this button repeatedly to switch between keyboard 1 (layer 1), keyboard 2 (layer 2), keyboard 3 (layer 3), and keyboard 4 (layer 4) recurrently.
-

4. Touchpad

This is the pointing device of the notebook.

5. Keyboard

The built-in keyboard provides all the functions of a full-sized keyboard. Refer to **How to Use the Keyboard** for details.

6. Status LED



Caps Lock

Glowes when the Caps Lock function is activated.

7. Status LED



Num Lock

Glowes when the Num Lock function is activated.

Front Side View

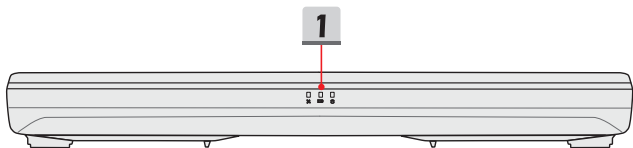

1. Status LED



Wireless LAN (WiFi)

- LED glows when WLAN (WiFi) function is enabled.
- LED goes out when this function is disabled.



Battery Status

- LED glows when the battery is being charged.
- Continuously blinking if the battery fails. If the problem persists, please contact your local authorized retailer or service center.
- Battery LED goes out when it is fully charged or when the AC/DC adapter is disconnected.



Drive Activity Indicator

LED blinks when the system is accessing the internal storage drives.

Right Side View

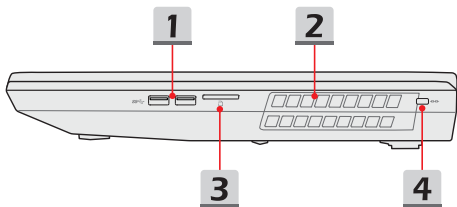

1. USB 3.0 Port

USB 3.0, the SuperSpeed USB, delivers the higher interface speeds for connecting various devices, such as storage devices, hard drives, or video cameras, and offers more advantages over high-speed data transferring.

2. Ventilator

The ventilator is designed to cool the system. DO NOT block the ventilator for air circulation.

3. Card Reader

The built-in card reader supports various types of memory cards. Check the Specifications for details.

4. Kensington Lock

This notebook provides a Kensington lock hole, which allows users to secure the notebook in place.

Left Side View

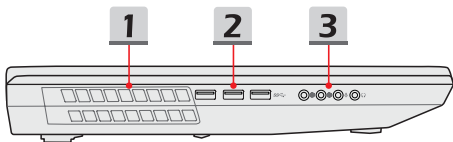

1. Ventilator

The ventilator is designed to cool the system. DO NOT block the ventilator for air circulation.

2. USB 3.0 Port

USB 3.0, the SuperSpeed USB, delivers the higher interface speeds for connecting various devices, such as storage devices, hard drives, or video cameras, and offers more advantages over high-speed data transferring.

3. Audio Port Connectors

Make high quality sound blaster with stereo system and Hi-Fi function supported.



Line Out

A connector for speakers.



Line In

Used for an external audio device.



Microphone

Used for an external microphone.



Headphone

A connector for speakers or headphones.

Rear Side View

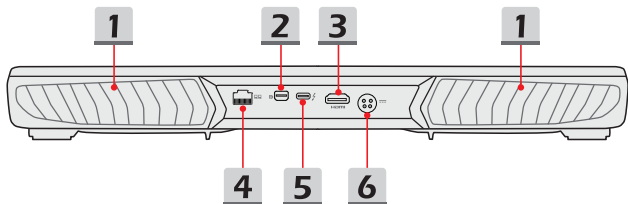

1. Ventilator

The ventilator is designed to cool the system. DO NOT block the ventilator for air circulation.

2. Mini-DisplayPort

The Mini-DisplayPort is a miniaturized version of the DisplayPort, with a suitable adapter, the Mini-DisplayPort may be used to drive displays with a VGA, DVI or HDMI interface.

3. HDMI Connector

HDMI (High-Definition Multimedia Interface) technology is the industry-leading interface and de-facto standard connecting high-definition (HD) and ultra high-definition (UHD) equipment.

4. RJ-45 Connector

The Ethernet connector, with optionally supported transmitting rate of 10/100/1000/10000 megabits per second, is used to connect a LAN cable for network connection.

5. Thunderbolt (Type-C)(optional)

Thunderbolt™ 3 supports up to 40Gbps data rate, dual 4K displays monitor output, USB3.1 connection, and portable charging power up to 5V/3A when AC power is connected.

6. Power Connector

This connector is to connect the AC/DC adapter and supply power for the notebook. Refer to "Begin to Use the Notebook" in chapter 3 for details.

Bottom Side View

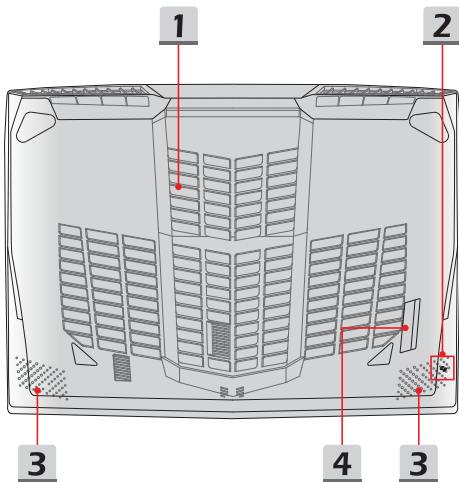

1. Ventilator

The ventilator is designed to cool the system. DO NOT block the ventilator for air circulation.

2. Battery Reset Hole

Whenever the system firmware (EC) is upgraded or the system hangs, please 1) power off the notebook; 2) remove the AC power; 3) use a straightened paperclip to insert this hole for 10 sec; 4) connect the AC power; 5) power on the notebook.

3. Stereo Speakers

This notebook may be equipped with built-in stereo speakers which deliver the high quality sound, and supports the HD audio technology.

4. Woofer Speaker

The woofer speaker is to reproduce low-pitched audio frequency.

How to Use the Keyboard

This notebook provides a full functional keyboard. To ensure that the keyboard will be functional properly, it is a must to install SCM application before using the keyboard function keys.

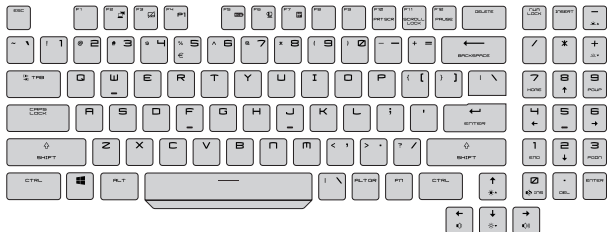

Windows Key



You can find the Windows Logo key on the keyboard which is used to perform Windows-specific functions, such as opening the Start menu and launching the shortcut menu.

Quick Launch Keys

Use the [Fn] combination keys on the keyboard to activate the specific applications or tools. With the help of these keys, users will be able to do work more efficiently.



User Defined

- Press both **Fn** and **F4** keys to launch the User Defined application.
-



ECO Mode

- Press **Fn** and **F5** keys to switch to **ECO Mode**, the power saving mode provided by **SHIFT** function.
-



Webcam

- Press **Fn** and **F6** keys to turn the **Webcam** function on. Press again to turn it off.
 - Webcam is turned off under default settings.
-



SHIFT

- Press **Fn** and **F7** keys repeatedly to switch among **Turbo Mode** (optional)/ **Sport Mode**/ **Comfort Mode**/ **ECO Mode**/ **Power Options** to shift the performance depending on users' demand.
 - Be noted that the selections of **Turbo Mode**/ **Sport Mode**/ **Comfort Mode** will only be available when AC Power is connected.
 - Refer to the Notebook Software Application Manual for further details.
-

Disable or Enable Touchpad



Enable or disable the touchpad function.

Switch Display



Switch the display output mode between the LCD, external monitor and both.

Use Multiple Monitors



If users connect an additional monitor to the notebook, the system will automatically detect the external monitor connected. Users will be allowed to customize the display settings.

- Connect the monitor to the notebook.
 - Press and hold the Windows key, and then press [P] key to bring up [Project].
 - Select how you want your display to project on the second screen from the selections of PC screen only, Duplicate, Extend, and Second screen only.
-

Adjust the Brightness Level of the Display



Increase the LCD brightness.



Decrease the LCD brightness.

Adjust the Sound Level of the Speaker

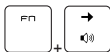

Increase the built-in speaker's volume.

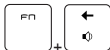

Decrease the built-in speaker's volume.



Mute the built-in speakers.

Adjust the Brightness Level of the Keyboard Backlight LED (optional)



Increase the brightness level of the keyboard backlight LEDs.



Decrease the brightness level of the keyboard backlight LEDs.

Application: True Color (optional)

This notebook may be pre-installed the **True Color** application. With this application, users can select various color settings for the best viewing experience.

Refer to the Notebook Software Application Manual for detailed instructions.



True Color

- Press and hold the **Fn** key, and then press the **Z** key to launch the **True Color** application.



**True Color
Selections**

- Press and hold the **Fn** key, and then press the **A** key to change different view modes.

Video: How to Use [Fn] Buttons









Watch the instruction video at: <https://www.youtube.com/watch?v=u2EGE1rzfrQ>



Specifications

The specifications listed here is reference only, and may change without notice. The actual products sold are different from areas.

Visit MSI official website at www.msi.com, or contact the local retailers to learn the correct specifications of the product user purchased.

Physical Characteristic	
Dimension	428 (W) x 314 (D) x 34.6~58.1 (H) mm
Weight	4.73~4.565 kg
CPU	
Package	BGA
CPU Processor Type	Intel® Quad/ Dual Core Mobile Processor
Core Chip	
PCH	Intel® series
Memory	
Technology	DDR4, 2400
Memory	DDR4 SO-DIMM slots x 4
Maximum	Up to 64GB
Power	
AC/DC Adapter (1) (optional)	230W, 19.5V Input: 100~240V, 50~60Hz Output: 19.5V  11.8A  
AC/DC Adapter (2) (optional)	330W, 19.5V Input: 100~240V, 50~60Hz Output: 19.5V  16.9A  
AC/DC Adapter (3) (optional)	x2, 230W, 19.5V Input: 100~240V, 50~60Hz Output: 19.5V  18A   Note that Dual Power Box is required for dual AC/DC adapter connection.
Battery	8-cell
RTC Battery	Yes

Storage	
HDD form factor	x1, 2.5" HDD
SSD (optional)	x2, M.2 SSD, SATA/ PCIE combo x1, M.2 SSD, SATA
I/O Port	
USB	x 5 (USB 3.0)
Thunderbolt™ 3	x 1, USB 3.1, Type-C interface, 4K output supported, 5V/3A output charging optionally supported
Mic-in	x 1
Headphone-out	x 1 (S/PDIF-Out supported)
Line-In	x 1
Line-Out	x 1
RJ45	x 1
HDMI	x 1
Mini-DisplayPort	x 1
Card Reader	x 1 (SD4.0)
Communication Port	
LAN	Supported
Wireless LAN	Supported
Bluetooth	Supported
Display	
LCD Type	17.3" FHD/ 4K UHD anti-glare LED panel
Video	
Graphics	<ul style="list-style-type: none">• NVIDIA® GeForce® discrete graphics• Intel® HD UMA graphics• Virtual Reality optionally supported
VRAM	GDDR5, based on GPU structure
Webcam	
Resolution	FHD

Audio

Internal Speakers	x 2
-------------------	-----

Internal Woofer	x 1
-----------------	-----

Security

Trusted Platform
Module
(optional)

TPM 2.0 is a hardware-based encryption device that collaborates with software measures to form a more advanced and secure data protection.

TPM functionalities can be de/activated in BIOS settings where appropriate.

With professional versions of Windows, BitLocker is the default console available for TPM communications serving data encryption purposes.

How to Get Started

User's Manual
NOTEBOOK

Begin to Use the Notebook

For a new user of this notebook, we would like to suggest you follow the illustrations below to begin to use the notebook.

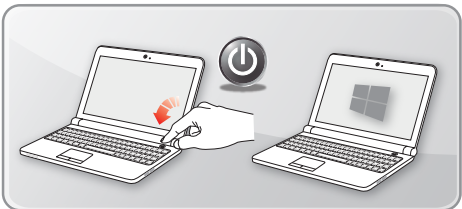
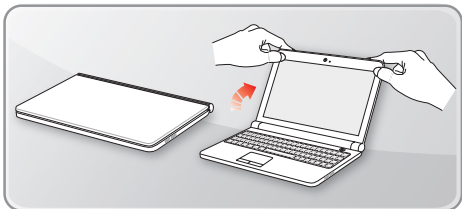
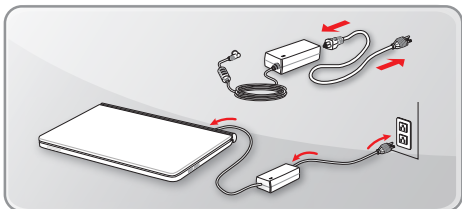

If your product comes with 2 adapters and 1 DualPower Box, it's a must to follow the illustration below to begin to use the notebook.

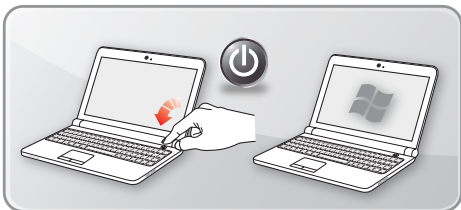
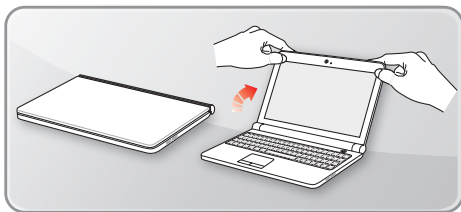
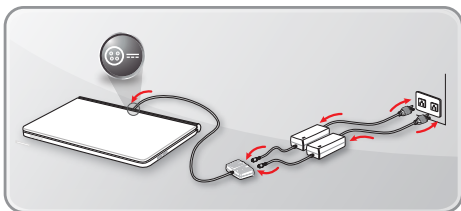

How to Use the Notebook Comfortably

If you are a beginner to the notebook, please read the following instructions to assure your own safety, and make yourself comfortable during the operations.

- ▶ Good illumination is essential in the work area.
- ▶ Choose a chair and desk with good ergonomics and adjust their heights according to your posture.
- ▶ Adjust the backrest to support your lower back comfortably when you are sitting upright.
- ▶ Place your feet flat on the floor with your knees bent to a 90 degrees.
- ▶ Adjust the angle/position of the LCD panel to have an optimal view.
- ▶ Stretch and relax your body regularly. Always take a break after working for a period of time.

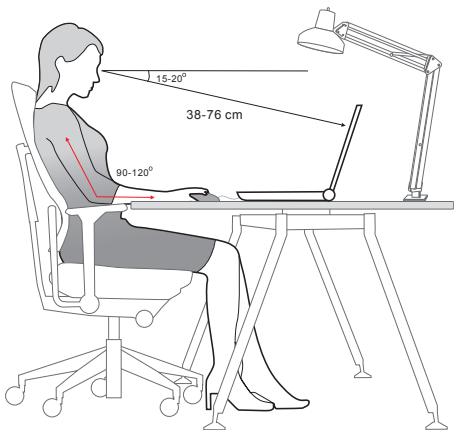

How to Manage Power Supply

This section provides users basic safety precautions to take when using an AC/DC adapter and battery power properly.

AC/DC Adapter

Ensure that your notebook is connected to an AC power source via the AC adapter before turning it on for the first time. If the notebook automatically shuts down due to low battery power, it is likely to cause system failure. Below are some Dos and Don'ts of an AC/DC adapter.

- ▶ Dos
 - Use the adapter that shipped with your notebook only.
 - Always be aware of heat coming from the in use AC/DC adapter.
 - Unplug the AC power cord before disassembly the notebook.
- ▶ Don'ts
 - Cover an in-use adapter since it can generate heat.
 - Have the AC power cord plugged after powering off the system when the notebook is going to be left unused for a longer time.

Battery

When you get a new notebook or a new notebook battery, it is important to know how to charge and care for your battery in order to get the most out of it for as long as you can.

Be aware of that the battery may not be replaced by users.

- ▶ **Safety guidelines**
 - This notebook is equipped with a non-removable battery, follow the local regulations while discarding the notebook.
 - Always keep the notebook and its battery away from excessive moisture and extreme temperatures.
 - Always unplug the AC power cord before installing any module to the notebook.

▶ **Battery type**

- This notebook may be equipped with a high-capacity Li-ion or Li-polymer battery pack depending on the model you have.
- The rechargeable battery pack is an internal power source of the notebook.

▶ **Battery charging behavior**

To optimize battery life and avoid a sudden power loss, read the tips below:

- Suspend system operation if the system will be idle for a while or shorten the suspend timer's time period.
- Turn off the system if you won't be using it for a period of time.
- Disable unnecessary settings or remove idle peripherals.
- Connect an AC/DC adapter to the system whenever possible.

▶ **How to charge the battery properly**

Please pay attention to the following tips before recharging the battery:

- If a charged battery pack is not available, save your work and close all running programs and shut down the system.
- Plug in an AC/DC adapter.
- You can use the system, suspend system operation or shut down and turn off the system without interrupting the charging process.
- The Li-ion or Li-polymer battery has no memory effect. It is unnecessary to discharge the battery before recharging. However, to optimize the life of battery, we suggest that consuming the battery power completely once a month is necessary.
- The actual charging time will be determined by the applications in use.

How to Set Up a Power Plan in Windows 10

A power plan is a collection of hardware and system settings that manages how your computer uses and conserves power. Power plans can save energy, maximize system performance, or balance energy conservation with performance. The default power plans — Balanced and Power saver — meet most people's needs. But you can modify settings for existing plans or create your own plan.

Choose or Customize a Power Plan

1. Find [Windows] icon in the lower-left corner of the screen. Right click it to unfold the selection menu. Select [Power Options] within the menu.
2. Select [Additional power settings] under [Related settings].
3. Choose a Power Plan by left clicking on one of the selections from the Power Plan list. The Power Plan of [Balanced] is selected as an example here. Click on the [Change plan settings] to the right of the power plan to customize a power plan.
4. Choose the sleep and display settings you want your computer to use. Click on [Change advanced power settings] to make changes to the selected power plan settings to meet your needs.
5. To restore the selected Power Plan back to its default settings, click on [Restore plan defaults] and then click [Yes] to confirm.
6. Click [OK] to finish.

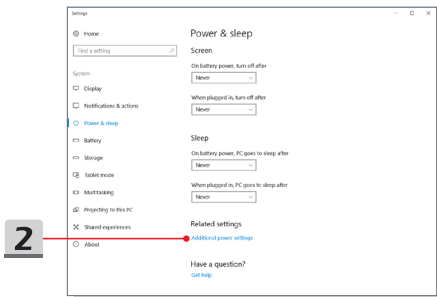
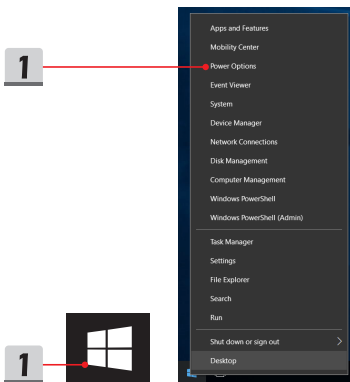

3

Choose or customize a power plan

A power plan is a collection of hardware and system settings (like display brightness, sleep, etc.) that manages how your computer uses power. [Tell me more about power plans](#)

Plans shown on the battery meter

- Balanced (recommended)** [Change plan settings](#)
Automatically balances performance with energy consumption on capable hardware.
- Power saver [Change plan settings](#)
Saves energy by reducing your computer's performance where possible.

Hide additional plans

- Gaming [Change plan settings](#)
- High performance [Change plan settings](#)
Favors performance, but may use more energy.

4

Change settings for the plan: Balanced

Choose the sleep and display settings that you want your computer to use.

On battery | Plugged in

Turn off the display: 5 minutes | 5 minutes

Put the computer to sleep: 10 minutes | 10 minutes

Adjust plan brightness: [slider]

[Change advanced power settings](#)

[Restore default settings for this plan](#)

6

Power Options

Advanced settings

Select the power plan that you want to customize, and then choose settings that reflect how you want your computer to manage power.

[Change settings that are currently unavailable](#)

Balanced [Active]

- Balanced
 - Require a password on wakeup
 - On battery: No
 - Plugged in: No
 - Hard disk
 - Internet Explorer
 - Desktop background settings
 - Wireless Adapter Settings
 - Sleep
 - USB settings

[Restore plan defaults](#)

5

Power Options

Are you sure you want to restore this plan's default settings?

Clicking "Yes" immediately restores all of the plan's default settings.

Yes No

OK Cancel Apply

Create Your Own Power Plan

You can create your own power plan and customize it as your requirement. However, it will be recommended to use ECO Mode power saving function to optimize the battery life while using this notebook.

Please refer to the section of System Control Manager (SCM) in the Notebook Software Application Manual for details.

1. Select Power Options in the menu. Click [Create a power plan] in the left pane.
2. Select an existing plan that meet your needs most, and give the plan a name. Click [Next] to continue.
3. Change the settings for the new power plan. Click [Create] to make the customized power plan taking effect.
4. Now you have a new power plan that is automatically set as active.

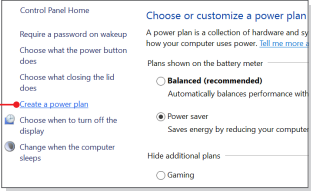
1 

Control Panel Home

Choose or customize a power plan

Require a password on wakeup
Choose what the power button does
Choose what closing the lid does

[Create a power plan](#)

Choose when to turn off the display
Change when the computer sleeps

A power plan is a collection of hardware and system settings that manages how your computer uses power. [Tell me more about power plans](#)

Plans shown on the battery meter

Balanced (recommended)
Automatically balances performance with energy consumption on capable hardware.

Power saver
Saves energy by reducing your computer's performance where possible.

Hide additional plans

Gaming

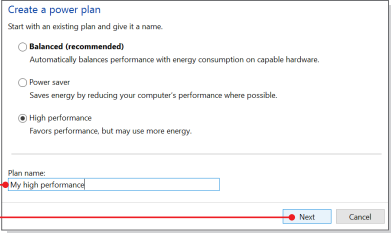
2 

Create a power plan

Start with an existing plan and give it a name.

Balanced (recommended)
Automatically balances performance with energy consumption on capable hardware.

Power saver
Saves energy by reducing your computer's performance where possible.

High performance
Favors performance, but may use more energy.

Plan name:

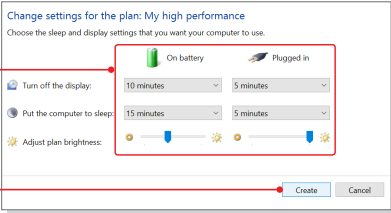
3 

Change settings for the plan: My high performance

Choose the sleep and display settings that you want your computer to use.

On battery | Plugged in

Turn off the display: 10 minutes | 5 minutes

Put the computer to sleep: 15 minutes | 5 minutes

Adjust plan brightness:

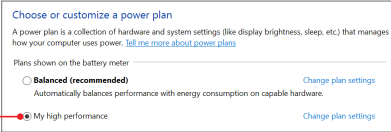
4 

Choose or customize a power plan

A power plan is a collection of hardware and system settings (like display brightness, sleep, etc.) that manages how your computer uses power. [Tell me more about power plans](#)

Plans shown on the battery meter

My high performance [Change plan settings](#)

Balanced (recommended)
Automatically balances performance with energy consumption on capable hardware. [Change plan settings](#)

How to Use the Touchpad

The touchpad integrated in your notebook is a pointing device that is compatible with standard mouse, allowing you to control the notebook by pointing the location of the cursor on the screen.



► **Configure the Touchpad**

You can customize the pointing device to meet your personal needs. For example, if you are a left-handed user, you may want to swap the functions of the two buttons. In addition, you can change the size, shape, moving speed and other advanced features of the cursor on the screen.

To configure the touchpad, you can use the standard Microsoft or IBM PS/2 driver in your Windows operating system. The Mouse Properties in Control Panel allows you to change the configuration.

► **Position and Move**

Place your finger on the touchpad (usually using the forefinger), and the rectangular pad will act as a miniature duplicate of your display. When you move your fingertip across the pad, the cursor on the screen will move simultaneously to the same direction. When your finger reaches the edge of the pad, lift your finger and place it on a proper location of the touchpad to continue the movement.

▶ Point and Click

When you have moved and placed the cursor over an icon, a menu item or a command that you want to execute, simply tap slightly on the touchpad or press the left button to select. This procedure, called as point and click is the basics of operating your notebook. Unlike the traditional pointing device such as the mouse, the whole touchpad can act as a left button, so that your each tap on the touchpad is equivalent to pressing the left button. Tapping twice more rapidly on the touchpad is to execute a double-click.

▶ Drag and Drop

You can move files or objects in your notebook by using drag-and-drop. To do so, place the cursor on the desired item and slightly tap twice on the touchpad, and then keep your fingertip in contact with the touchpad on the second tap. Now, you can drag the selected item to the desired location by moving your finger on the touchpad, and then lift your finger from the touchpad to drop the item into place. Alternately, you can press and hold the left button when you select an item, and then move your finger to the desired location; finally, release the left button to finish the drag-and-drop operation.

About HDD and SSD

This notebook may be equipped with hard disk drive (HDD) or solid state drive (SSD) depending on the models users purchased.

The hard disk drive and solid state drive are the data storage devices used for storing and retrieving digital information. Most SSDs use NAND-based flash memory, and have higher data transfer rates, lower power consumption, and faster read/write speed than HDDs.

Do not attempt to remove or install the HDD and SSD when the notebook is powered on. Please consult an authorized retailer or service center for the replacement of the HDDs and SSDs.

About M.2 SSD Slot

The notebook may be equipped with M.2 SSD slots for M.2 SSD cards, which are compatible with SATA or PCIe interfaces, providing diverse features and usages to users. Consult an authorized retailer or service center for correct specifications and installations.

How to Connect the Internet

Wireless LAN

Wireless LAN is a wireless broadband connection that allows you to connect to the Internet without using any cables. Follow the instructions below to set up a Wireless LAN connection.

► Wireless LAN Connection

1. Go to the desktop. Find the  icon in the lower-right corner of the task bar and click on it to unfold the settings menu.
2. There are [Wi-Fi] and [Airplane mode] two options in the Network settings, select [Wi-Fi] here.
3. Choose one Wireless LAN connection from the network list to connect to the Internet. Click [Connect] to continue.
4. A security key may be required for connecting the selected network. Then click [Next].

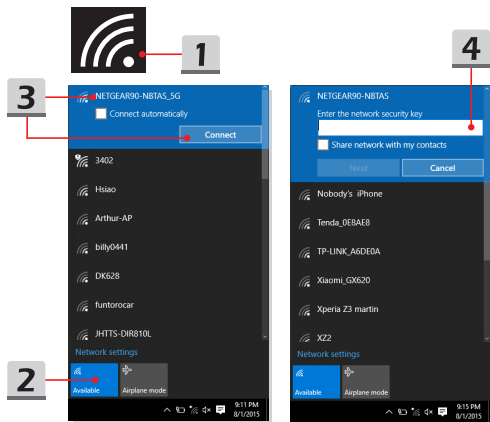

How to Get Started

► Check the Wireless LAN status

When Airplane mode is enabled, Wireless LAN connection will be turned off. Before setting up a Wireless LAN connection, make sure that Airplane mode is turned off.

1. Go to the desktop. Find the  icon in the lower-right corner of the task bar and click on it to unfold the settings menu.
2. Check if Wireless LAN mode is available in the Network settings.
3. Or, find the [SCM] icon in the lower-right corner of the task bar and click on it to bring out the main window of System Control Manager, please check if Wireless LAN mode is turned on.

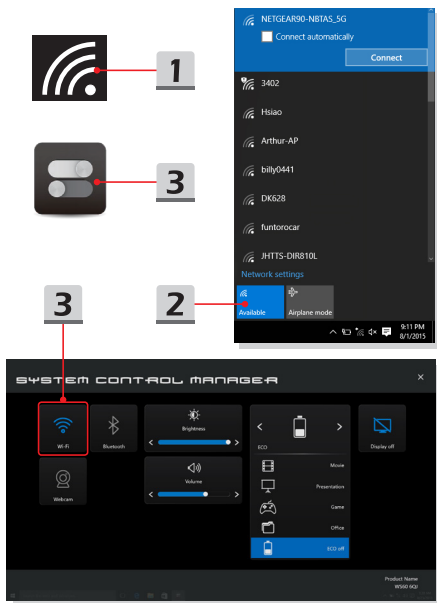

Wired LAN

Using cables and network adapters to connect to the Internet. Before setting up the connection of Dynamic IP/PPPoE or Broadband (PPPoE) or Static IP, contact your Internet Service Provider (ISP) or network administrator for assistance of setting up Internet connection.

► Dynamic IP/PPPoE Connection

1. Go to the desktop. Find the  icon in the lower-right corner of the task bar, and then right click on it to select [Open Network and Sharing Center].
2. Choose [Change adapter settings].
3. Right click on [Ethernet] to select [Properties] from the drop-down menu.
4. In the Ethernet Properties window, select [Networking] tab and check [Internet Protocol Version 4 (TCP/IPv4)]. Then click [Properties] to continue.
5. Select [General] tab, click [Obtain an IP address automatically] and [Obtain DNS server address automatically]. Then click [OK].

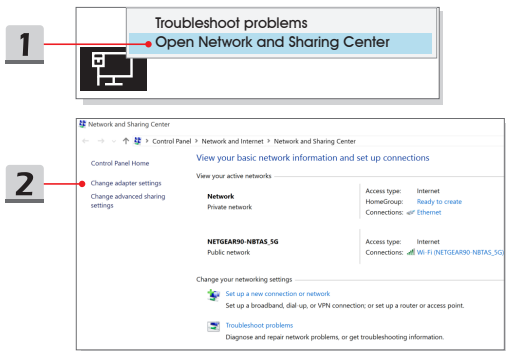

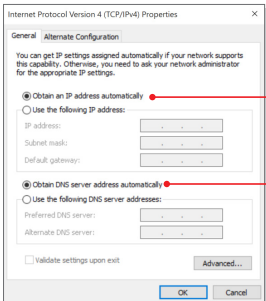
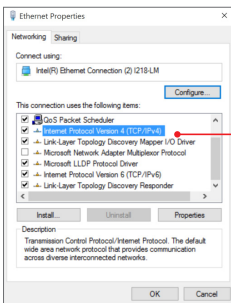
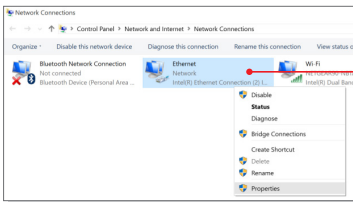

► Broadband (PPPoE) Connection

1. Go to the desktop. Find the  icon in the lower-right corner of the task bar, right click on it to select [Open Network and Sharing Center].
2. Select [Set up a new connection or network] under [Change your networking settings].
3. Select [Connect to the Internet], and then click [Next].
4. Click [Broadband (PPPoE)].
5. Fill User name, Password, and Connection name fields. Then click [Connect].

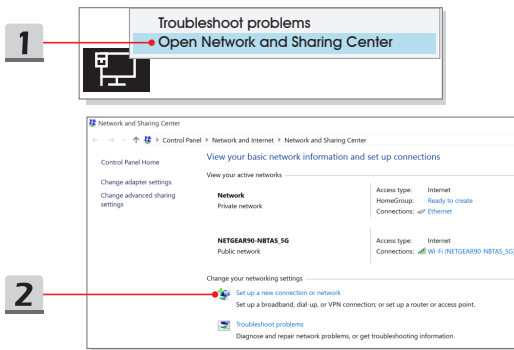

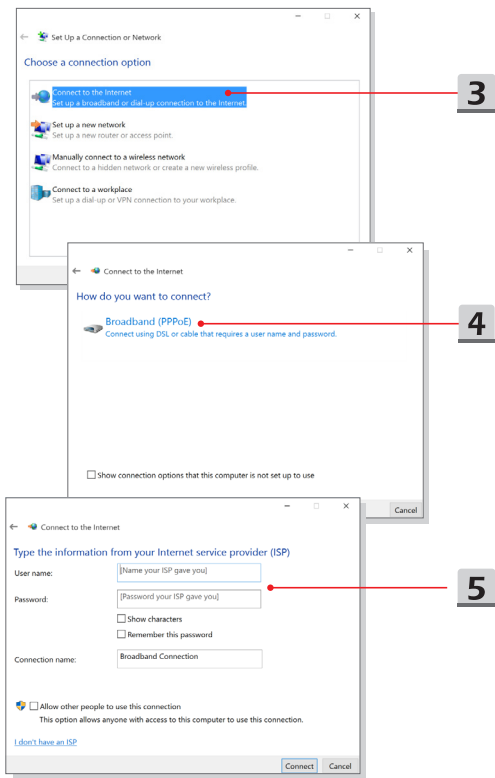

► Static IP Connection

1. Follow the previous steps 1 to 4 in Dynamic IP/PPPoE Connection.
2. Select [General] tab and click [Use the following IP address] and [Use the following DNS server addresses]. You will be asked to fill the IP address, Subnet mask, and Default gateway, and then click [OK].

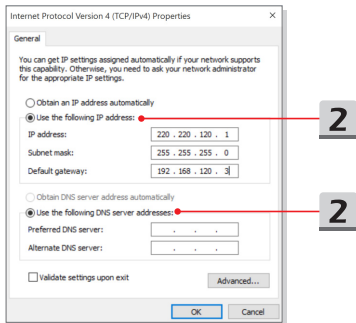

How to Set Up Bluetooth Connection

Bluetooth pairing is a process in which two Bluetooth devices communicate with each other through an established connection.

Activating Bluetooth Connection

- ▶ Checking the Bluetooth status

When Airplane mode is enabled, Bluetooth connection will be turned off. Before setting up a Bluetooth connection, make sure that Airplane mode is turned off.

1. Go to the desktop. Find the  icon in the lower-left corner of the screen and click on it.
2. Select [Settings] to bring out [Windows Settings] menu, and then select [Devices] to enter the next Settings menu.
3. Select [Bluetooth & other devices].
4. Switch [On] the Bluetooth connection if it is set to [Off].
5. Or, find the [SCM] icon in the lower-right corner of the task bar and click on it to bring out the main window of System Control Manager. Check if Bluetooth connection is switched on.

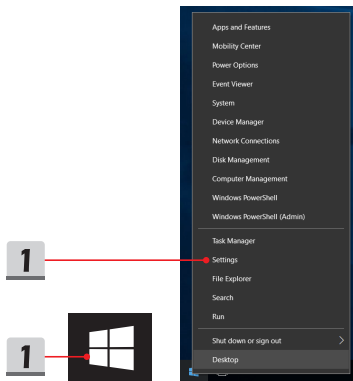

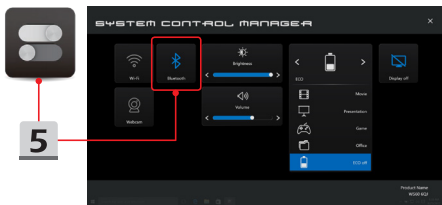
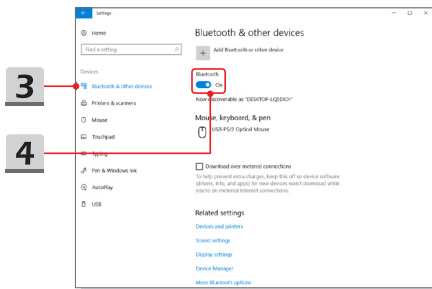
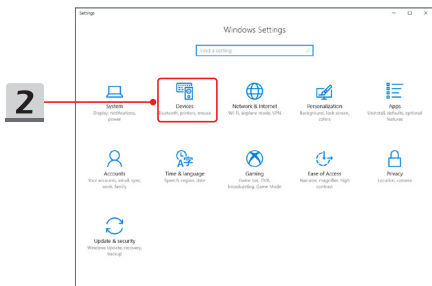

► Pairing the Bluetooth devices

1. Go to [Start/ Settings/ Devices], and then find [Bluetooth & other devices].
2. Click on [Add Bluetooth or other device].
3. Click on [Bluetooth].
4. Select a device to start pairing.
5. Give the passcode as instructed by the device waiting to be connected, and then click on [Connect] to continue.

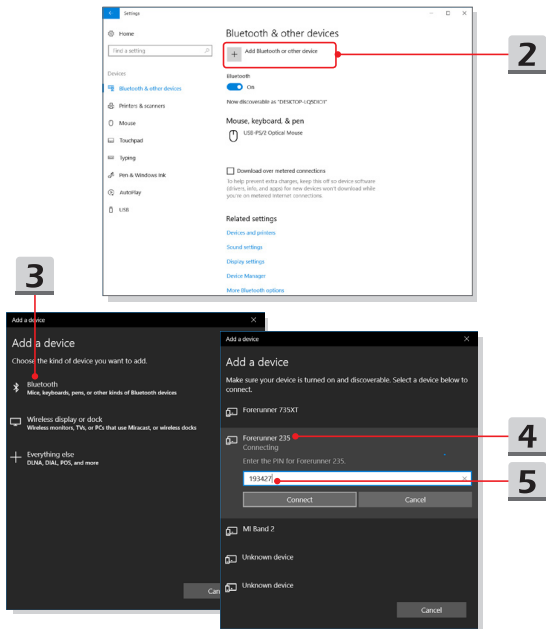

How to Connect External Devices

This notebook may be equipped with various connecting I/O (input/output) ports, such as USB, HDMI, DisplayPort, and mini DisplayPort. Users will be able to connect diverse peripheral devices to the notebook.

To connect these devices, refer to the instruction manuals of each device first, and then connect the device to the notebook. This notebook is capable to auto detect the connected devices, and if there is no detection of the devices, please manually enable the devices by going to [Start Menu/ Control Panel/ Hardware and Sound/ Add a device] to add the new devices.

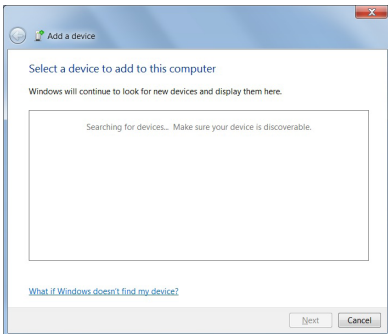
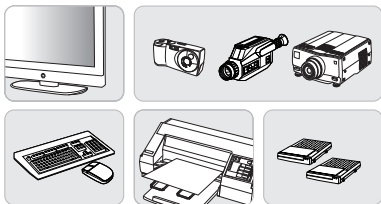

Video: How to Use RAID Function

This notebook may support RAID function of different levels. RAID allows users to store data on multiple hard disk drives or solid state drives. Contact the local dealer for further and correct information and be noted that the supported RAID functions may vary depending on the models users purchased.

Watch the instruction video at: <https://youtu.be/u2C35-ctFbw>



How to Select Boot Mode in BIOS

1. Power on the system. As soon as the first logo screen appears, press the DEL key immediately and enter the BIOS menu.
2. Move the cursor to [Boot] tab, and select [Boot mode select] in Boot Configuration.
3. For operating systems support UEFI-based BIOS (Windows 10 and Windows 8.1), it is suggested to select [UEFI].
4. For Windows 7 or previous versions of Windows, select [Legacy] mode.
5. Refer to MSI FAQ for further information about installing Windows operating system on the notebook at <https://www.msi.com/faq/notebook-1971>

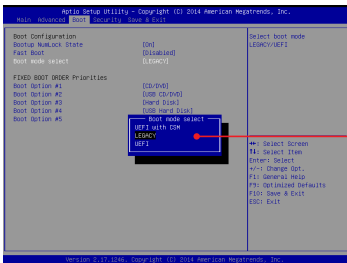
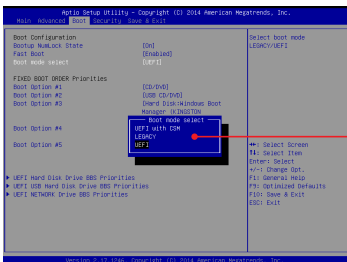

Video: How to Restore Windows 10 Operating System on MSI Notebooks

Watch the instruction video at: <https://www.youtube.com/watch?v=hSrK6xAQooU>, to restore the Windows 10 operating system by using [F3 Recovery] and [Windows 10 Settings] when it is needed.



Video: How to Use MSI One Touch Install

MSI **"One Touch Install"**, the one-click installer application, allows users to efficiently install all needed drivers on MSI notebooks with single click.

Watch the instruction video at:

Windows 10/ 8.1: <https://www.youtube.com/watch?v=ERITRaJUKQs>

Windows 7: <https://www.youtube.com/watch?v=43lnM4m-500>



