



BG-N4

BATTERY GRIP

Designed For The Nikon D7000
SLR Camera

 VELLO™

USER'S MANUAL

Introduction

Thank you for choosing Vello and congratulations on your new BG-N4 battery grip purchase. Enjoy the many benefits that a battery grip offers, such as extended shooting time and more control and comfort when shooting in a vertical (portrait) orientation.

The Vello BG-N4 is compatible with the Nikon D7000 DSLR camera. The BG-N4 accepts one Nikon EN-EL15 rechargeable battery, in addition to the camera's internal battery. Six AA batteries (alkaline, Ni-MH, lithium, or nickel-manganese) can be used instead for added convenience. The BG-N4 is equipped with an alternate shutter-release button, AE-L/AF-L button, multi selector, a main and sub-command dial for shooting in a vertical position.



Please read through this entire manual before using the BG-N4 battery grip.

Precautions

The BG-N4 should only be used with compatible devices specified in this manual.

Only use with batteries and battery holders recommended in this manual.

Cover the power terminals with the contact cap when the BG-N4 is not in use. This prevents electrical shorts caused by metal objects touching the power terminals.

When the battery holder is removed from the grip, remove the batteries or place the holder in a container to prevent electrical shorts caused by contact with other metal objects.

The memory card access lamp may light up when the BG-N4 is mounted or removed from the camera. This is part of the normal operation.

If you notice smoke, an unusual smell or noise from the battery pack, discontinue use immediately.

Remove the batteries and take the device to a Vello authorized reseller.

The BG-N4 does not have a power switch. Instead, use the camera power switch to turn the power on or off.

The battery level may not display properly if batteries are inserted before mounting the grip.

Remove batteries from the grip when not in use.

Do not attempt to disassemble.

Avoid water or extreme humidity and keep in a dry and cool place.

Keep out of reach of children.

Overview

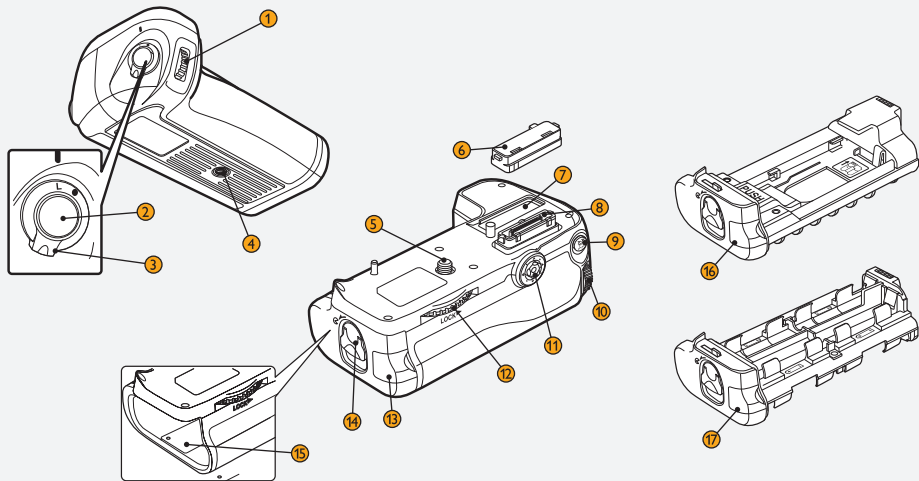

① Sub-Command Dial *

② Shutter-Release Button *

③ Control Lock Switch

To prevent accidental triggering, the control lock switch locks the shutter-release button, AE-ON button, multi selector dial, as well as the main and sub-command dials on the BG-N4. Unlock prior to use by switching to the ● position. The control lock is not a power switch.

④ Tripod Socket

⑤ Mounting Screw

⑥ Contact Cap

⑦ Camera Contact Cover Holder

⑧ Signal Contacts

⑨ AE-L/AF-L Button *

⑩ Main Command Dial *

⑪ Multi Selector *

⑫ Attachment Wheel

⑬ Battery Chamber Cover

⑭ Battery Chamber Latch

⑮ Battery Chamber

⑯ EN-EL15 Battery Holder

For EN-EL15 rechargeable batteries.

⑰ AA Battery Holder

Holder for six AA batteries.

** These controls perform the same function as their on-camera equivalents and are affected by changes to the Custom Settings menu (Group a for the AE-L/AF-L button, Group f for other controls). See camera manual for details.*

Attaching The Grip



Ensure that the power is turned off on the camera and that the Control Lock on the BG-N4 is in the **L** position before attaching the grip.

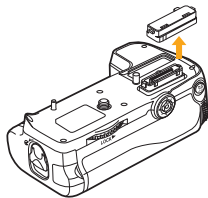

Remove the contact cap from the BG-N4 battery grip. Replace the cap when not in use to protect the contacts.



The contacts for the BG-N4 are on the bottom of the camera where they are protected by a contact cover. Remove the contact cover before mounting the grip.

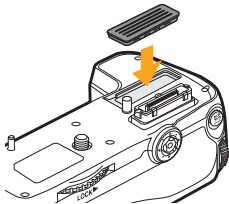

To prevent loss, place the camera contact cover in the contact cover holder on the BG-N4 by pushing it into the groove until it is secure.

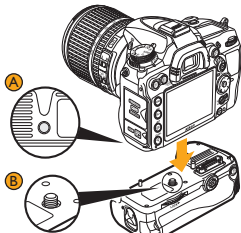

Connect the BG-N4 grip to the camera, while aligning the camera's tripod socket **A** with the grip's mounting screw **B**.

Removing the battery from the camera before mounting the grip is not required.

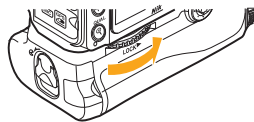

Rotate the attachment wheel in the direction shown by the LOCK arrow until it is firmly tightened.

Inserting Batteries

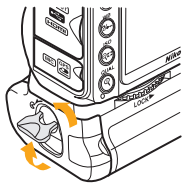

Ensure that the power is turned off on the camera and the Control Lock on the BG-N4 is in the **L** position. Turn the battery-chamber latch counter-clockwise to open the battery chamber door.

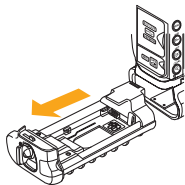

Remove the battery holder from the BG-N4 grip. The **EN-EL15** battery holder comes pre-installed when shipped.

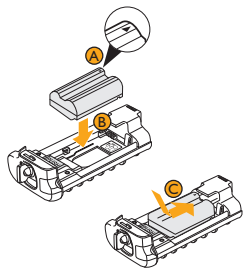

Nikon EN-EL15 Batteries: Match the arrow on the battery **A** with the battery holder's contacts and push the battery down **B**. Slide the battery as indicated by the arrow **C** until it clicks into place.

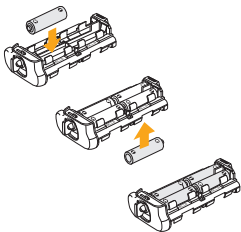

AA Batteries: Place six AA batteries of the same type in the **AA** battery holder as shown, while ensuring that they are in the correct orientation.

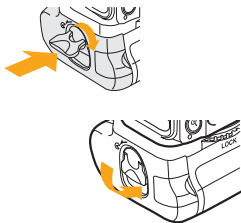

Insert the battery holder into the grip and turn the latch clockwise to lock it and return the latch to the down position. Turn the camera on and check the battery level in the control panel or viewfinder.

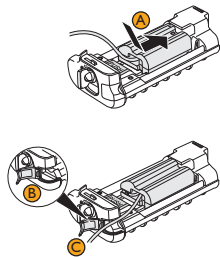









To use the Nikon EP-B5 DC coupler (sold separately), insert the adapter into the **EN-EL15** battery holder in the same manner as a regular battery **A**. Open the latch **B** and pass the cable through **C**.





Battery Info

The camera displays the following battery levels .

Nikon EN-EL15 battery:

Control Panel	Viewfinder	Description
	—	Battery fully charged.
	—	Battery partially discharged.
		
		
		Low battery. Prepare spare batteries.
 (blinking)	 (blinking)	Battery exhausted. Shutter release is disabled.

AA Batteries:

Control Panel	Viewfinder	Description
	—	Battery fully charged.
		Low battery. Prepare spare batteries.
 (blinking)	 (blinking)	Battery exhausted. Shutter release is disabled.

AA Battery Settings

To ensure that the camera shows the correct battery level when AA batteries are used, choose the appropriate setting in the Custom Settings menu (Group d).

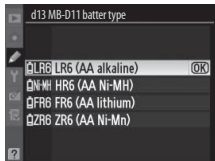

Battery Type	Menu Option To Select
AA alkaline (LR6)	LR6 (AA alkaline)
AA Ni-MH (HR6)	HR6 (AA Ni-MH)
AA Lithium (FR6)	FR6 (AA lithium)
AA nickel-manganese (ZR6)	ZR6 (AA Ni-Mn)

Nikon Rechargeable Batteries

The camera can display information (including calibration information) for the Nikon EN-EL15 battery via the Battery Info

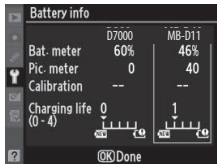

option in the Setup Menu. Only battery levels are displayed for AA batteries.

Battery Order

Set the order in which the internal camera and BG-N4 batteries are used via the Custom Settings menu (Group d). When the camera is drawing power from the BG-N4, a **BP** icon is displayed in the control panel.

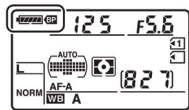

Removing The Batteries

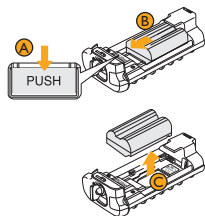

EN-EL15 Holder: While pressing and holding the **PUSH** button (A) on the holder, slide the battery toward the button (B) and lift up to remove (C).

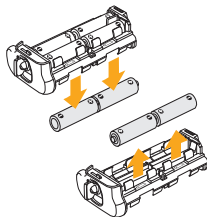

AA Holder: Remove the batteries one row at a time (as shown). Ensure that the batteries do not drop during this process.

Battery & Power

EN-EL15 Batteries

At low temperatures of about 50° F (10° C) and below, the Nikon EN-EL15 batteries will decrease in performance. Warming up a cold battery can recover some of the lost charge. AA batteries have less capacity and lose more performance at low temperatures.

AA Batteries

In most cases, the Nikon EN-EL15 battery will provide better performance than AA batteries when used in the Vello BG-N4. AA LR6 alkaline and ZR6 nickel- manganese batteries have limited capacity and therefore should only be used when there is no other alternative. Performance of AA batteries decreases significantly at temperatures below 68 °F (20 °C) and is therefore not recommended.

Remove the batteries when the BG-N4 is not in use.

Specifications

Power Source	One EN-EL15 rechargeable Li-ion battery or six LR6 Alkaline, HR6 Ni-MH, FR6 Lithium, or ZR6 Nickel-Manganese AA batteries
Operating Temperature	32 – 104 °F (0 – 40 °C)
Dimensions	Approximately 133.5 x 49.5 x 72.8 mm/5.2 x 1.9 x 2.8 in.
Weight	Approximately 248 g (8.7 oz.), with EN-EL15 battery holder (excluding batteries)

* Approximate measurements.

Specifications and design are subject to change without notice.



© Copyright 2011 Gradus Group Inc.
All other trademarks are the property of their respective owners