



**Make It Yours.**

# MASTERCASE H500M

User manual / English

التثبيت دليل / Arabic

Инструкция за експлоатация / Български

安装说明 / 简体中文

安裝說明 / 繁體中文

Užívateľská príručka / Čeština

Handuch / Deutsch

Εγχειρίδιο χρήσης / Ελληνικά

Manual de Usuario / Español

Manuel de l'utilisateur / Français

Felhasználói kézikönyv / Magyar

فارسی / راهنمای کاربری

Manuale d'uso / Italiano

ユーザーズマニュアル / 日本語

Handleiding / Nederlands

설치 안내 / Korean

Instrukcja Użytkownika / Polski

Manual do Usuário / Português















Руководство пользователя / русский

Uputstvo za korišćenje / Srpski

Kullanım Kılavuzu / Türkçe

Panduan Pengguna / Indonesia

# 1. PACKAGE CONTENT

Item	Pics	Name	Q'ty	Used for
01		Ø5*10 Screw	12	Top Fan / Front Fan
02		#6 - 32*29 Screw	8	Top Fan
03		Stand-off Socket	1	Motherboard Tray
04		Stand-off	7	Motherboard Tray
05		#6 - 32*10 Screw	2	Lock HDD Bracket
06		#6 - 32*5 Screw	13	PSU / Motherboard Tray
07		M3*4 Screw	8	2.5" SSD
08		#6 - 32*4 Screw	12	360mm Radiator
09		Cable Tie	10	Cable Management
10		Cleaning Cloth	1	Cleaning Glass
11		3 to 4 Cable	1	Connect to Fan
12		SSD screw	24	SSD
13		ARGB Extension Cable	1	Control Board
14		Front Glass Panel	1	Front Panel
15		Micro USB Cable	1	Control Board

## 2. COMPATIBILITY

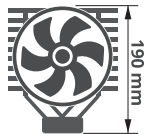
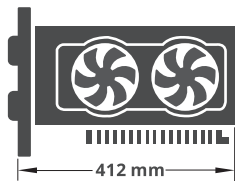
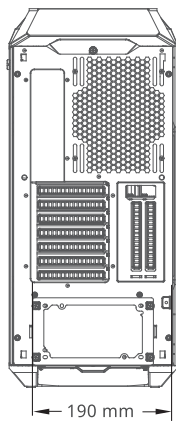
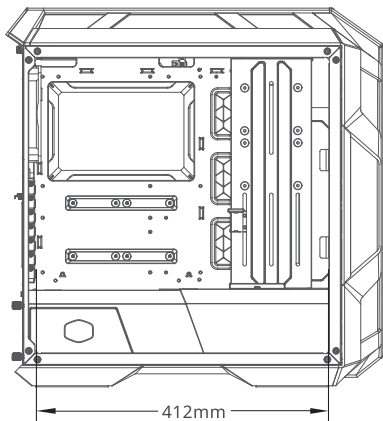

# 3. MOTHERBOARD INSTALLATION

1

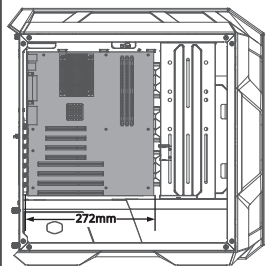

2

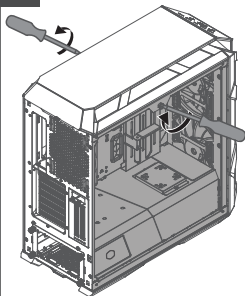

3

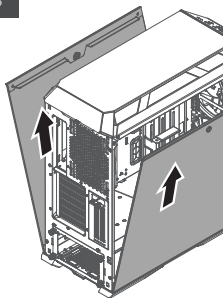

4

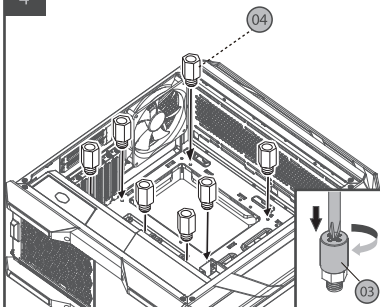

5

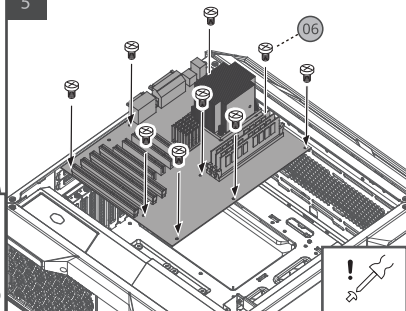

# 4. POWER SUPPLY INSTALLATION

1

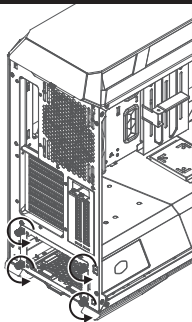

2

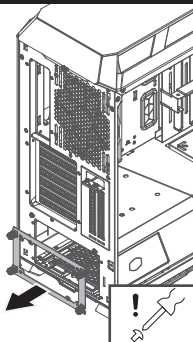

3

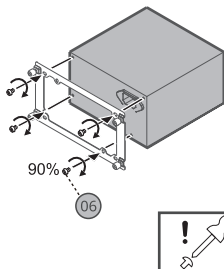

4

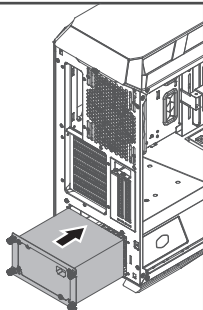

5

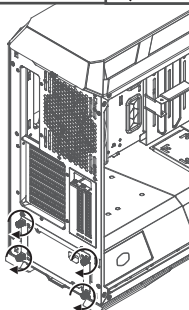

6

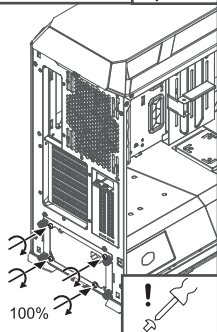

# 5. HARD DRIVE INSTALLATION

1

A. 2.5" HDD/SSD

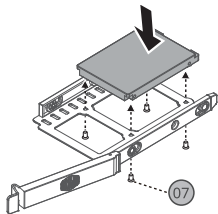

2

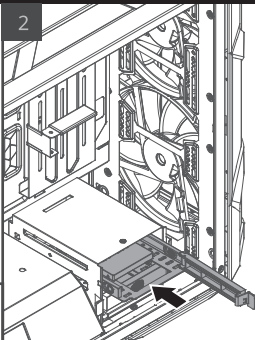

3

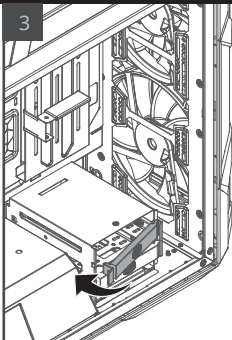

1

B. 3.5" HDD

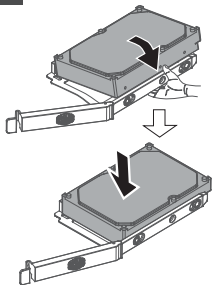

2

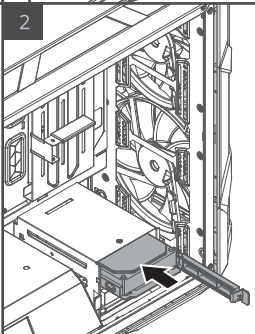

3

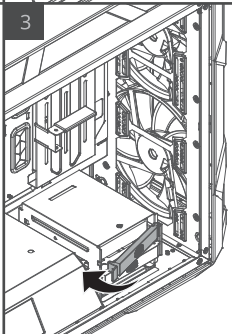

1

C.2.5" HDD/SSD

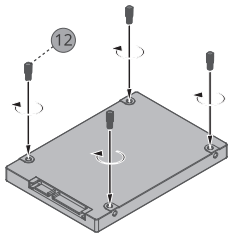

2

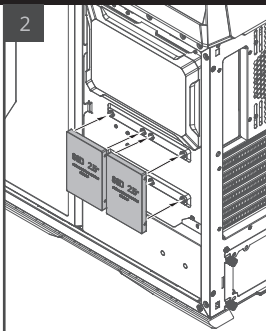

3

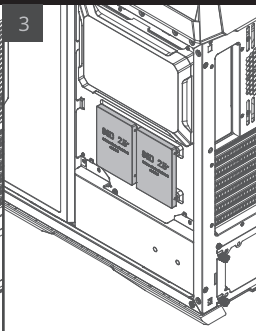

1

D.2.5" HDD/SSD

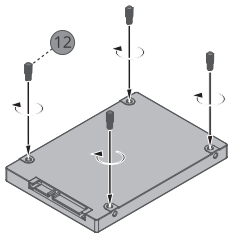

2

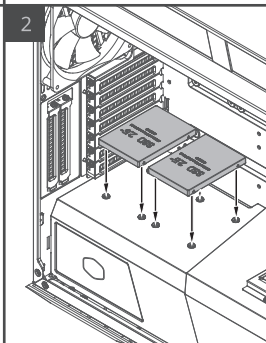

3

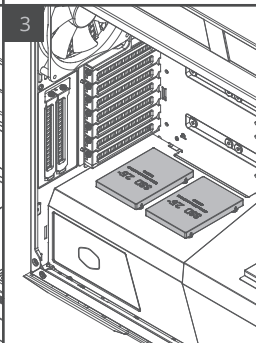

1

E. 2.5" HDD/SSD

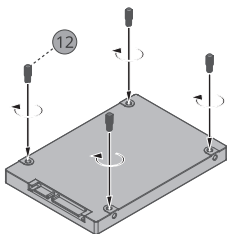

2

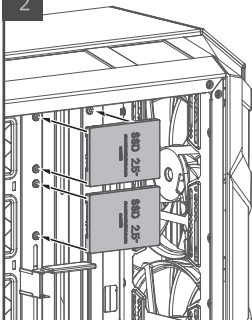

3

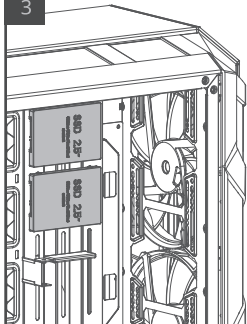

# 6. FRONT FAN INSTALLATION

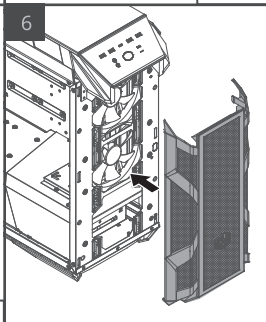
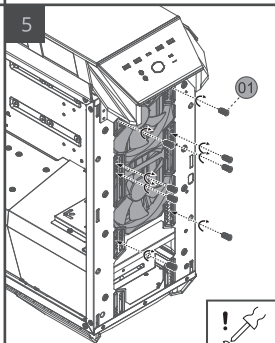
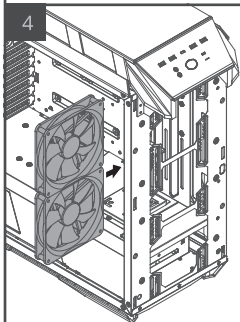
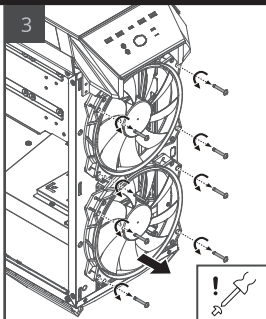
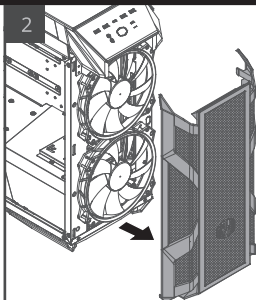
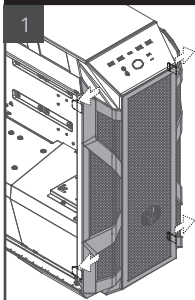

# 7. TOP FAN INSTALLATION

A1

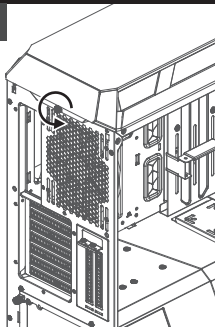

A2

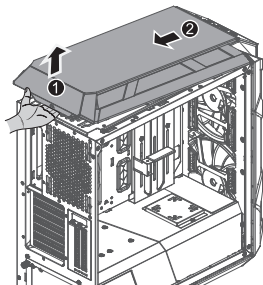

A3

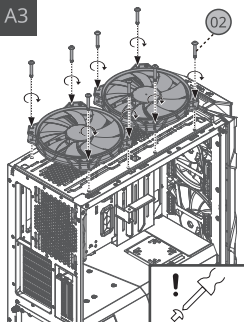

A4

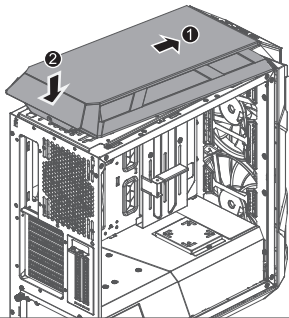

A5

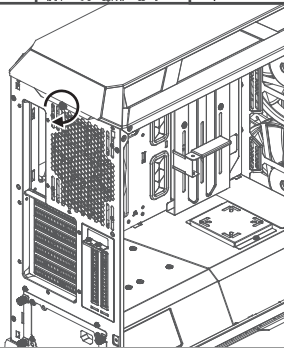

B1

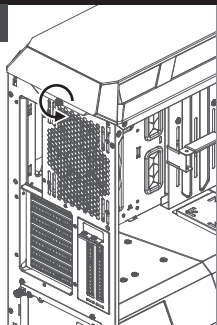

B2

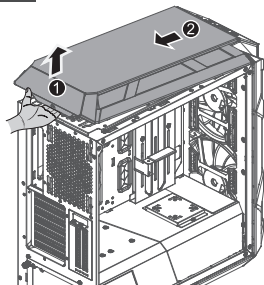

B3

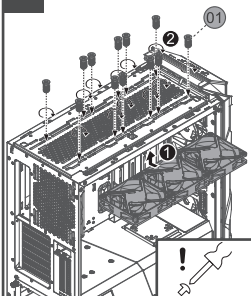

B4

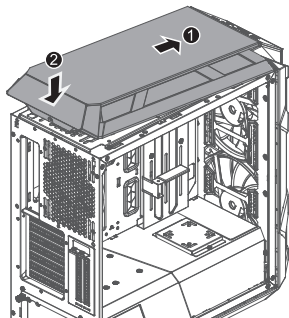

B5

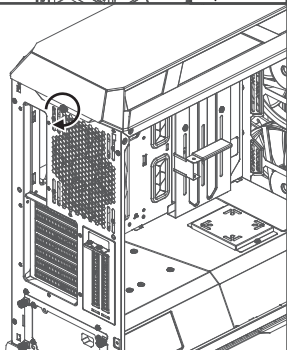

# 8. FRONT RADIATOR INSTALLATION

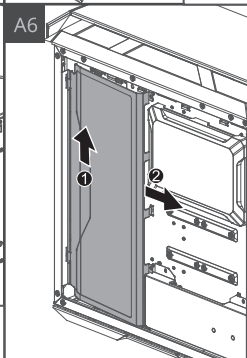
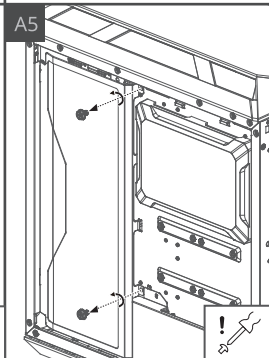
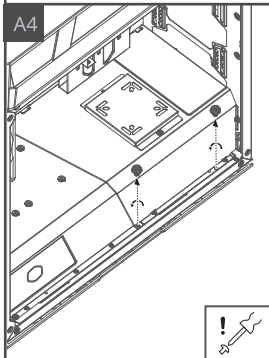
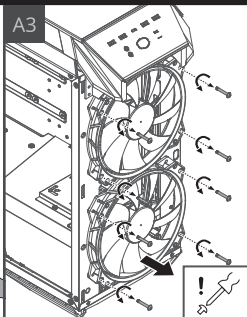
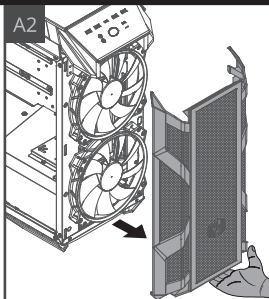
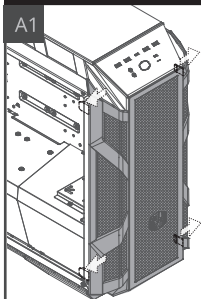

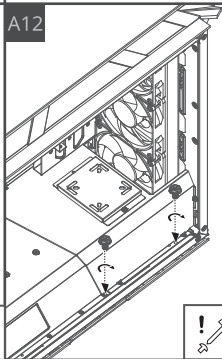
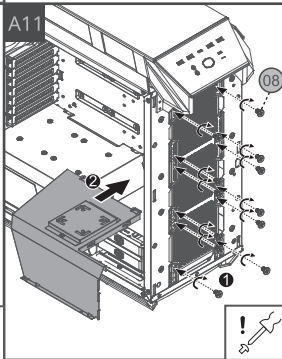
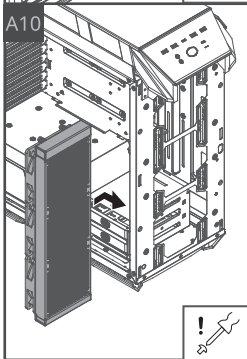
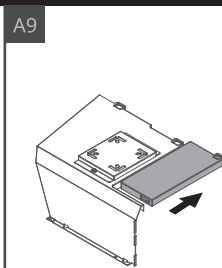
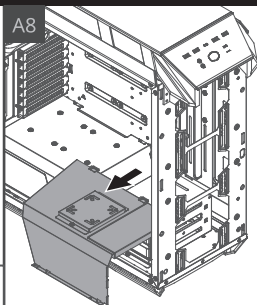
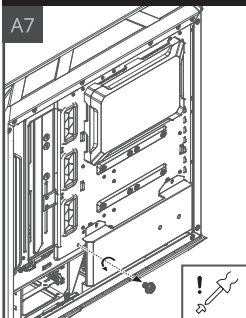

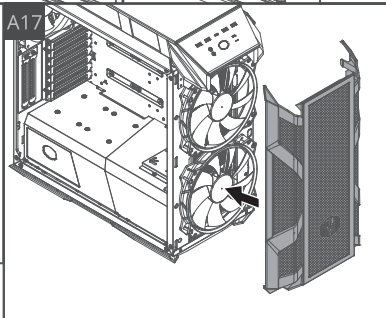
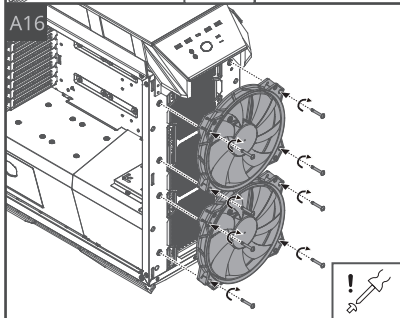
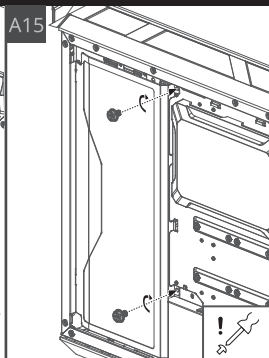
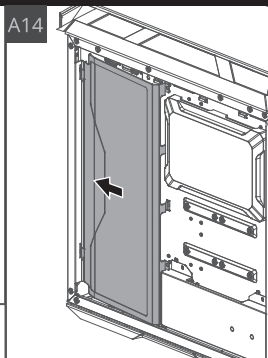
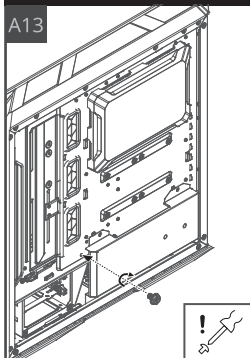

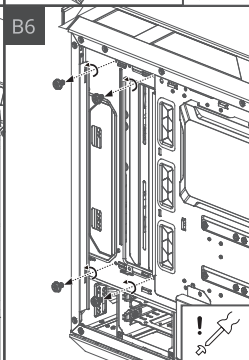
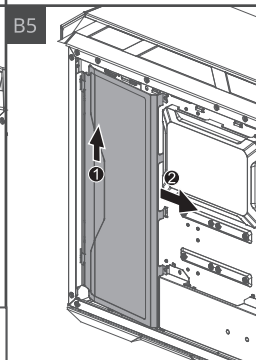
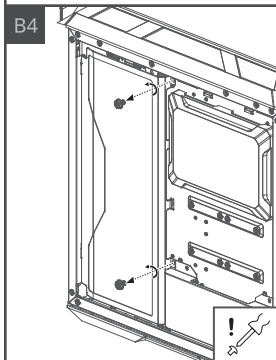
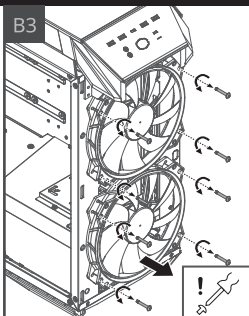
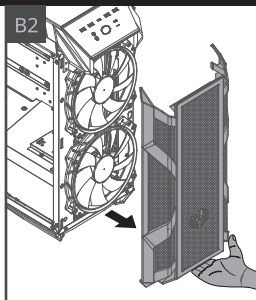
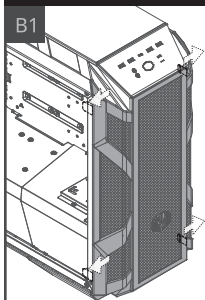

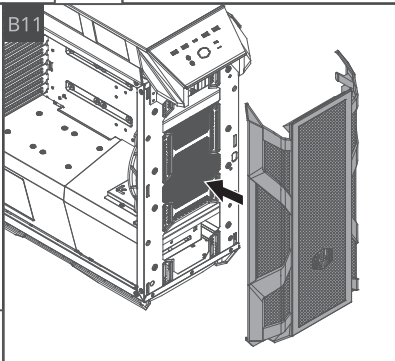
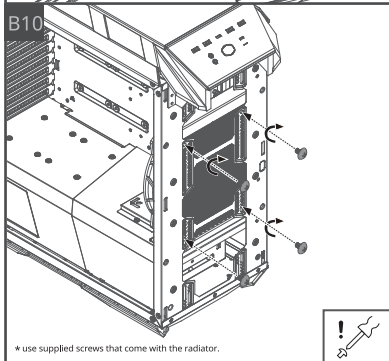
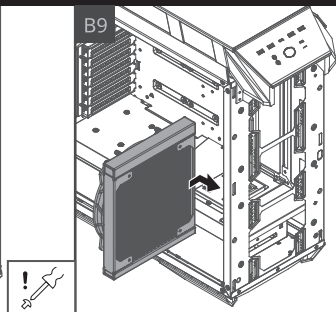
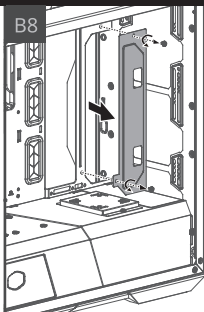
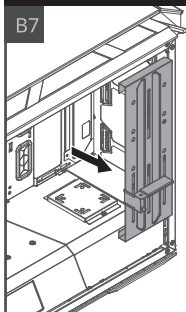

\* use supplied screws that come with the radiator.

# 9. TOP RADIATOR INSTALLATION

1

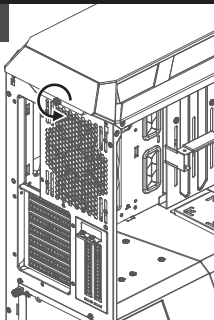

2

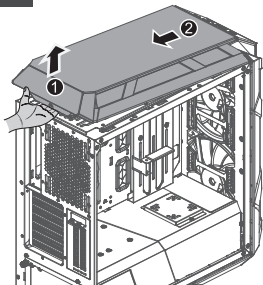

3

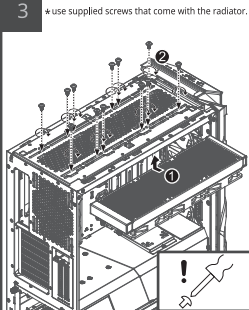

4

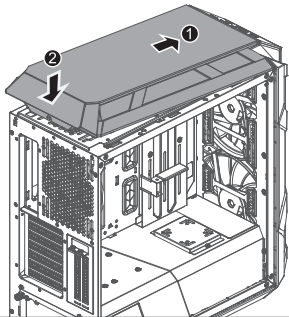

5

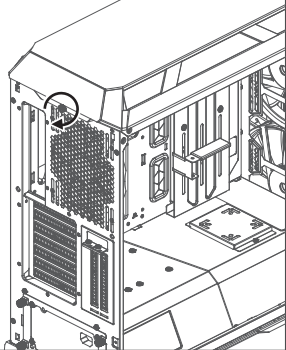

# 10. REAR RADIATOR INSTALLATION

1

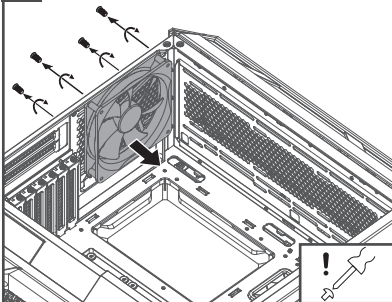

2

\* use supplied screws that come with the radiator.

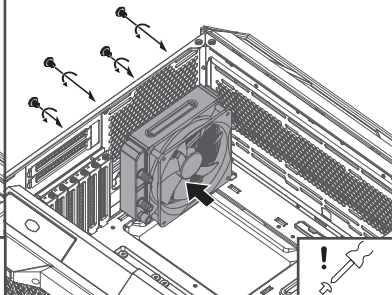

# 11. GFX SUPPORT ARM ADJUSTMENT

1

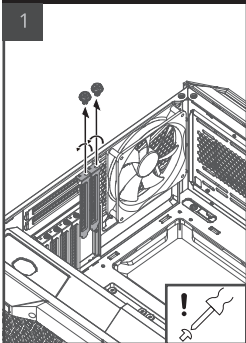

2

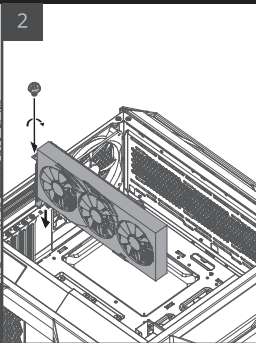

3

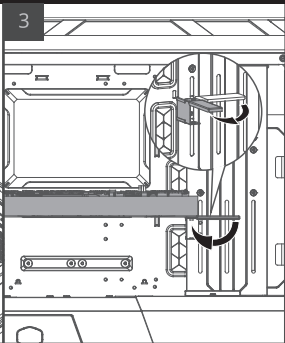

4

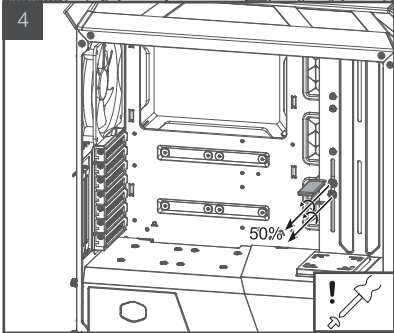

5

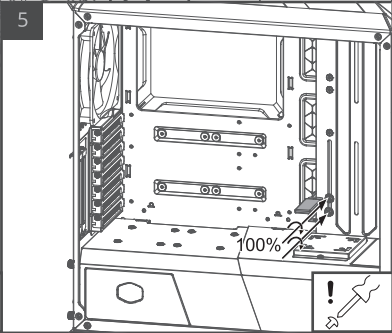

# 12. FRONT PANEL REPLACEMENT

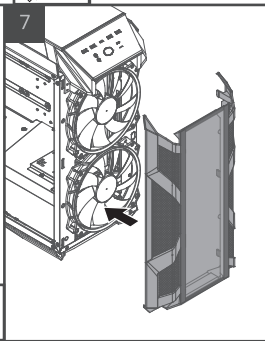
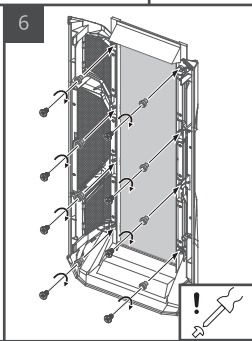
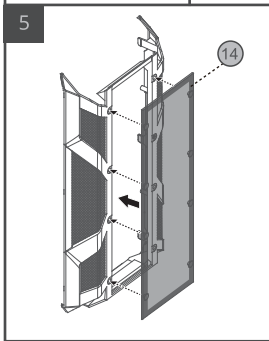
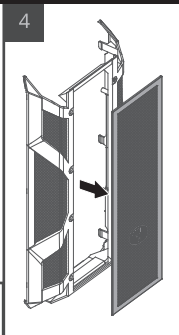
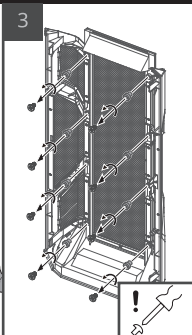
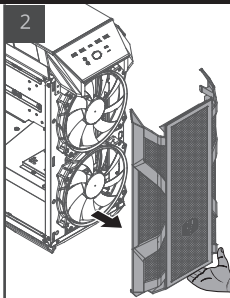
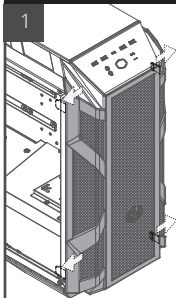

# 13. PUMP INSTALLATION

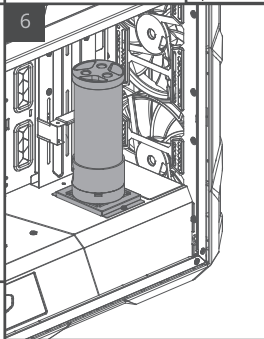
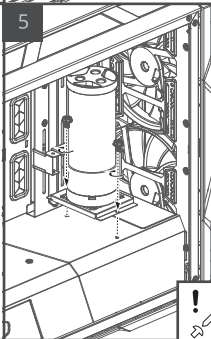
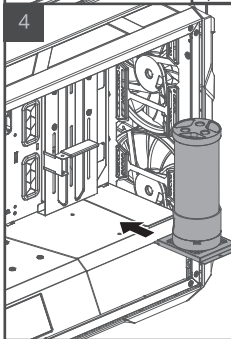
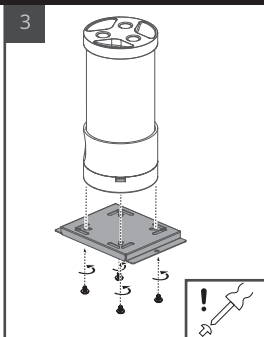
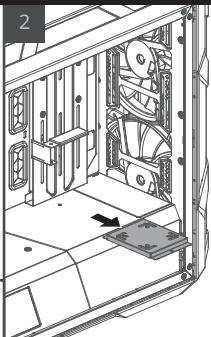
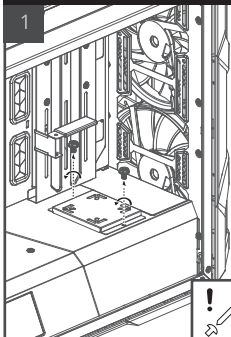

# 14. ARGB CONTROLLER INSTALLATION

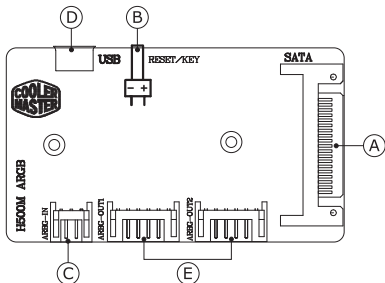
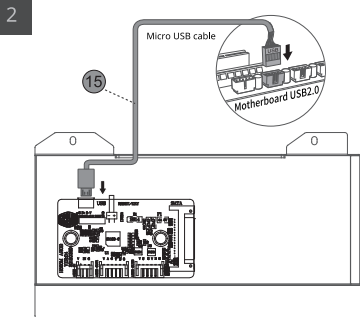
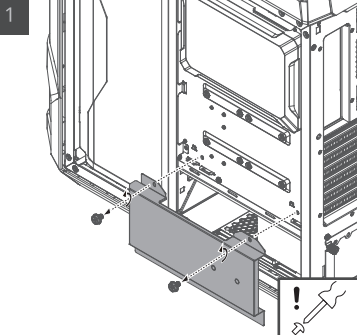

Connector Name	Description
A	SATA connector
B	Front panel control connector
C	M/B ARGB sync up connector
D	Micro USB connector
E	ARGB Fan connector

\*The maximum output of all ARGB and Fan connectors is 3A

# 15. ARGB FAN CONNECTION

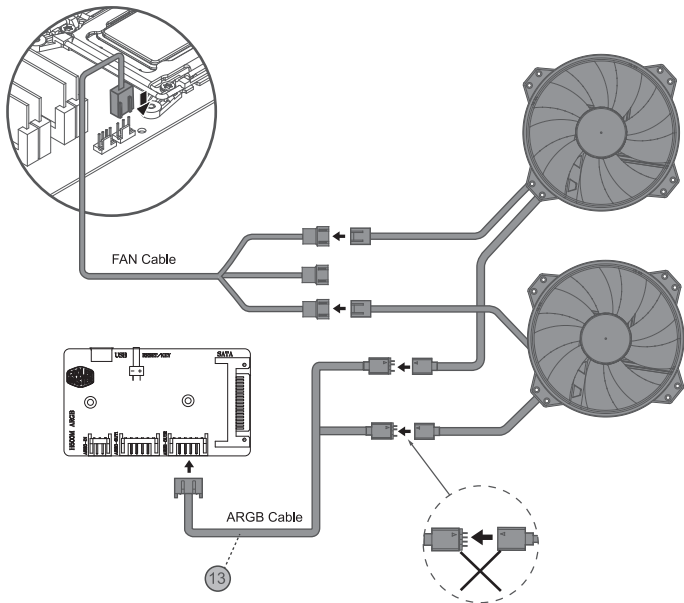

## English (EN)

1. Package content
2. Compatibility
3. Motherboard installation
4. Power supply installation
5. Hard drive installation
6. Front fan installation
7. Top fan installation
8. Front radiator installation
9. Top radiator installation
10. Rear radiator installation
11. GFX support arm adjustment
12. Front Panel replacement
13. Pump installation
14. ARGB controller installation
15. ARGB Fan Connection

## German (DE)

1. Lieferumfang
2. Kompatibilität
3. Installation der Hauptplatine
4. Installation des Netzteils
5. Installation der Festplatte
6. Installation von Front-Lüfter
7. Installation von Top-Lüfter
8. Installation eines Front-Radiators
9. Installation eines Top-Radiators
10. Installation eines Heck-Radiators
11. Justierung der Grafikkarten-Halterung
12. Austausch des Front-Panels
13. Installation einer Pumpe
14. Installation des ARGB Controllers
15. ARGB Lüfter-Anschluss

## Spanish (ES)

1. Contenido de la confección
2. Compatibilidad
3. Instalación tarjeta madre
4. Instalación alimentador
5. Instalación Hard Drive
6. Instalación ventilador frontal
7. Instalación ventilador Superior
8. Instalación Radiador Frontal
9. Instalación Radiador Superior
10. Instalación Radiador Posterior
11. Ajuste del brazo de soporte de la GFX
12. Reemplazo del panel frontal
13. Instalación de la bomba
14. Instalación del controlador ARGB
15. Conexión ventilador ARGB

## French (FR)

1. Contenu de l'emballage
2. Compatibilité
3. Installation de la carte mère
4. Installation de l'alimentation
5. Installation du disque dur
6. Installation du ventilateur frontal
7. Installation du ventilateur supérieur
8. Installation du radiateur frontal
9. Installation du radiateur supérieur
10. Installation du radiateur arrière
11. Réglage du support GFX
12. Remplacement du panneau frontal
13. Installation de la pompe
14. Installation du contrôleur ARGB
15. Connexion du ventilateur ARGB

## Italian (IT)

1. Contenuto della confezione
2. Compatibilità
3. Installazione scheda madre
4. Installazione alimentatore
5. Installazione Hard Drive
6. Installazione ventola frontale
7. Installazione ventola Superiore
8. Installazione Radiatore Frontale
9. Installazione Radiatore Superiore
10. Installazione Radiatore Posteriore
11. Regolazione del braccio di supporto della GFX
12. Sostituzione del pannello frontale
13. Installazione della pompa
14. Installazione controller ARGB
15. Connessione ventola ARGB

## Polish (PL)

1. Zawartość opakowania
2. Zgodność
3. Montaż płyty głównej
4. Montaż zasilacza
5. Montaż dysku twardego
6. Montaż wentylatora z przodu
7. Montaż wentylatora z góry
8. Montaż chłodnicy z przodu
9. Montaż chłodnicy z góry
10. Montaż chłodnicy z tyłu
11. Regulacja uchwytu karty graficznej
12. Wymiana panelu przedniego
13. Instalacja pompy
14. Instalacja kontrolera ARGB
15. Podłączenie wentylatora ARGB

## Russian (RU)

1. Содержание комплекта
2. Совместимость
3. Установка материнской платы
4. Установка блока питания
5. Установка жесткого диска
6. Установка переднего вентилятора
7. Установка верхнего вентилятора
8. Монтаж радиатора на передней панели
9. Монтаж радиатора на верхней панели
10. Монтаж радиатора на задней панели
11. Регулировка кронштейна GFX
12. Замена передней панели
13. Установка насоса
14. Установка контроллера ARGB
15. Подключение ARGB вентилятора

## Japanese (JA)

1. パッケージ内容
2. パーツ互換性
3. マザーボードの取り付け
4. 電源ユニットの取り付け
5. ストレージデバイスの取り付け
6. フロントファンの取り付け
7. トップファンの取り付け
8. 水冷ラジエータの取り付け(フロント)
9. 水冷ラジエータの取り付け(トップ)
10. 水冷ラジエータの取り付け(リア)
11. ビデオカードの設置、アームの調整
12. フロントパネルの取替
13. ポンプのインストール
14. アドレス指定可能なARGBコントローラーのインストール
15. ARGBファン接続

## Chinese (CHT)

1. 包裝內含物品明細
2. 相容性
3. 主機板安裝指南
4. 電源供應器安裝指南
5. 硬碟安裝指南
6. 前方風扇安裝指南
7. 上方風扇安裝指南
8. 前方水冷排安裝指南
9. 上方水冷排安裝指南
10. 後方水冷排安裝指南
11. 顯卡支撐臂可調整
12. 前面板可更換
13. 幫浦安裝
14. ARGB控制器安裝
15. ARGB風扇連接指南

## Chinese (CHS)

1. 包裝內含物品清單
2. 兼容性
3. 主板安裝指南
4. 电源安裝指南
5. 硬盘安裝指南
6. 前方風扇安裝指南
7. 上方風扇安裝指南
8. 前方水冷排安裝指南
9. 上方水冷排安裝指南
10. 后方水冷排安裝指南
11. 显卡支撐架調整方式
12. 玻璃前面板安裝指南
13. 水泵安裝指南
14. ARGB控制板安裝指南
15. ARGB風扇連接指南

## Bulgaria (BG)

1. Съдържание
2. съвместимост
3. монтаж на дънна платка
4. монтаж на захранващ блок
5. монтаж на твърд диск
6. монтаж на преден вентилатор
7. монтаж на горен вентилатор
8. монтаж на преден радиатор
9. монтаж на горен радиатор
10. монтаж на заден радиатор
11. Регулируемо рамо за GFX
12. Смяна на преден панел
13. Монтиране на помпа
14. Монтиране на ARGB контролер
15. Конектор за ARGB вентилатор

## Czech (CS)

1. balení obsahuje
2. kompatibilita
3. instalace základní desky
4. instalace napájecího zdroje
5. instalace pevného disku
6. instalace předního větráku
7. instalace vrchního větráku
8. instalace vodního chlazení zepředu
9. instalace vodního chlazení zvrchu
10. instalace vodního chlazení zezadu
11. Seřízení ramene podpory GFX
12. Výměna předního panelu
13. Instalace čerpadla
14. Instalace ovladače ARGB
15. Konektor ARGB ventilátoru

## Greek (EL)

1. Περιεχόμενα συσκευασίας
2. Συμβατότητα
3. Εγκατάσταση μητρικής πλακέτας
4. Εγκατάσταση τροφοδοτικού
5. Εγκατάσταση σκληρού δίσκου
6. Εγκατάσταση μπροστινού ανεμιστήρα
7. Εγκατάσταση επάνω ανεμιστήρα
8. Εγκατάσταση μπροστινού ψυγείου
9. Εγκατάσταση επάνω ψυγείου
10. Εγκατάσταση πίσω ψυγείου
11. Ρύθμιση βραχίονα στήριξης GFX
12. Αντικατάσταση front panel
13. Εγκατάσταση αντλίας
14. Εγκατάσταση ελεγκτή ARGB
15. Σύνδεση ARGB ανεμιστήρα

## Hungarian (HU)

1. A csomag tartalma
2. kompatibilitás
3. alaplap beszerelés
4. tápegység beszerelés
5. merevlemez beszerelés
6. elülső ventilátor állítás
7. felső ventilátor beszerelés
8. elülső radiátor beszerelés
9. felső radiátor beszerelés
10. hátsó radiátor beszerelés
11. GFX alátámasztó kar állítás
12. Előlap cseréje
13. Pumpa telepítése
14. ARGB vezérlő telepítése
15. ARGB Ventilátor Csatlakozás

## Dutch (NL)

1. Verpakkingsinhoud
2. Compatibiliteit
3. Moederbord installatie
4. Voeding installatie
5. Harde schijf installatie
6. Fan installatie voorkant
7. Fan installatie bovenkant
8. Radiator installatie voorkant
9. Radiator installatie bovenkant
10. Radiator installatie achterkant
11. Videokaart steun aanpassen
12. Front panel vervangen
13. Pomp installatie
14. ARGB controller installatie
15. ARGB fan aansluiting

## Portugal (PT)

1. Conteúdo da embalagem
2. Compatibilidade
3. Instalação da motherboard
4. Instalação da fonte de alimentação
5. Instalação do disco rígido
6. Instalação da ventoinha frontal
7. Instalação da ventoinha no topo
8. Instalação do radiador na frontal
9. Instalação do radiador no topo
10. Instalação do radiador na traseira
11. Ajuste do braço de suporte da GFX
12. Substituição do painel frontal
13. Instalação da bomba
14. Instalação do controlador ARGB
15. Conexão da ventoinha ARGB

## Serbian (SR)

1. Sadržaj pakovanja
2. kompatibilnost
3. instalacija matične ploče
4. instalacija napajanja
5. instalacija hard diska
6. instalacija prednjeg ventilatora
7. instalacija gornjeg ventilatora
8. instalacija prednjeg radijatora
9. instalacija gornjeg radijatora
10. instalacija zadnjeg radijatora
11. Nosač grafičke karte
12. Zamena prednjeg panela
13. Instaliranje pumpe
14. Instalacija ARGB kontrolera
15. Konektor ARGB ventilatora

## Turkish (TR)

1. Paket İçeriği
2. Uyumluluk
3. Anakart Kurulumu
4. Güç Kaynağı Kurulumu
5. Sabit Disk Kurulumu
6. Ön Fanın Takılması
7. Üst Fanın Takılması
8. Ön Radyatör Kurulumu
9. Üst Radyatör Kurulumu
10. Arka Radyatör Kurulumu
11. GFX Destek Koşu Ayarları
12. Ön Panel Değişimi
13. Pompa Kurulumu
14. ARGB Kontrolcü Kurulumu
15. ARGB fan bağlantısı

## Korean (KR)

1. 구성품 내용
2. 호환성
3. 메인보드 설치
4. 파워 서플라이 설치
5. HDD/SDD 설치
6. 전면 팬 설치
7. 상단 팬 설치
8. 전면 라디에이터 설치
9. 상단 라디에이터 설치
10. 후면 라디에이터 설치
11. GFX 지원 압 조정
12. 전면 패널 교체
13. 펌프 설치
14. ARGB 컨트롤러 설치
15. ARGB 팬 연결

## Indonesian (ID)

1. Isi Paket
2. Kompatibilitas
3. Instalasi Motherboard
4. Instalasi Power Supply
5. Instalasi Hard Disk
6. Instalasi Kipas Depan
7. Instalasi Kipas Atas
8. Instalasi Radiator Depan
9. Instalasi Radiator Atas
10. Instalasi Radiator Belakang
11. Pengaturan penyangga GPU
12. Front Panel Pengganti
13. instalasi pompa
14. Instalasi kontroler ARGB
15. ARGB Kipas Koneksi

## Farsi (FA)

1. محتویات الصندوق
2. سازگاری
3. نصب مادربرد
4. نصب منبع تغذیه
5. نصب هارد درایو
6. نصب فن جلو
7. نصب فن بالا
8. نصب رادیاتور جلو
9. نصب رادیاتور بالا
10. نصب رادیاتور جانبی
11. تنظیم بازوی پشتیبان کارت گرافیک
12. تعویض پنل جلو
13. نصب پمپ
14. نصب کنترلر کاندن ARGB
15. اتصال فن ARGB

## Arabic (AR)

1. محتویات الصندوق
2. التوافقية
3. تركيب اللوحة الرئيسية
4. تركيب مزود الطاقة
5. تركيب أقراص التخزين
6. تركيب المروحة الأمامية
7. تركيب المروحة بالأعلى
8. تركيب شبكة التبريد الأمامية
9. تركيب شبكة التبريد بالأعلى
10. تركيب شبكة التبريد بالخلف
11. تعديل ذراع حامل البطاقة الرسومية
12. اللوحة الامامية البديلة
13. تركيب المضخة
14. تركيب متحكم إضاءة ARGB
15. توصيلات مراوح ARGB



**Make It Yours.**

Asia Pacific - Cooler Master Technology Inc.  
8F, No. 788-1, Zhongzheng Rd., Zhonghe Dist.,  
New Taipei City 23586, Taiwan (R.O.C.),  
Tel: +886-2-2225-3517

China - Cooler Master China  
Room 2062, Floor 6, No. 421, Weiqing Rd.,  
Jinshan District, Shanghai City, China  
Tel: +86-21-51872177

Europe - Cooler Master Europe B.V.  
Lodewijkstraat 1b, 5652AC Eindhoven, The Netherlands  
Tel: +31-(0)40-702-0900

North America - Cooler Master NA  
4820 Schaefer Ave, Chino CA, 91710, USA  
Tel: +1-888-624-5099

South America  
E-mail: Soporte\_Latam@coolermaster.com.tw



**Product Page**

[www.coolermaster.com/qr/mastercase-h500m](http://www.coolermaster.com/qr/mastercase-h500m)



**Technical Support**

[account.coolermaster.com](mailto:account.coolermaster.com)

512001571-GP Ver 1.0: 2018/05 

The color and specification are subject to be changed without further notification.  
Please visit our website for updated information: [www.coolermaster.com](http://www.coolermaster.com)

©2018 Cooler Master Technology Inc. All Rights Reserved. All trademarks are registered to their respective owners.