



## Quick Connection Guide

[www.lorextechnology.com](http://www.lorextechnology.com)

## STEP 2: Setting Up the DVR

Next, you must set up the DVR and connect it to your network.

### To set up the DVR:

1. Connect the DVR to your router using the included Ethernet cable.
2. Connect the included power adapter to the DVR. Wait a few minutes for the system to start up.

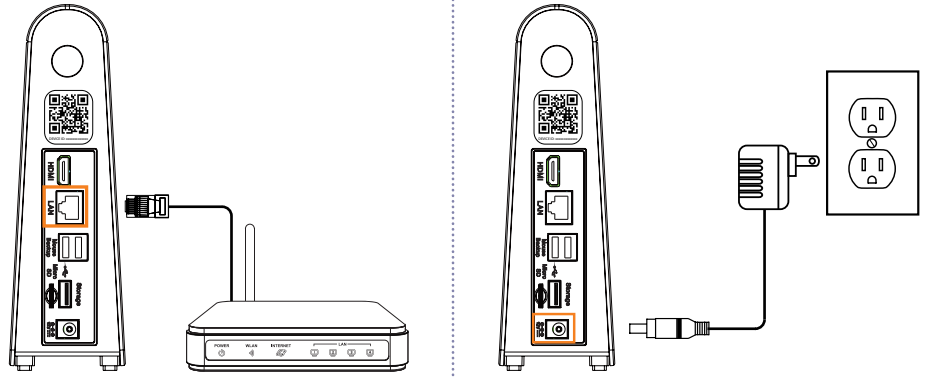

### OPTIONAL: Full DVR Setup

• This guide describes basic setup of the DVR only. This installation is intended for users who wish to monitor their system using the free Lorex Secure app on their smartphone or tablet.

• You may choose to use the DVR interface to control your wire-free security system. Connect the included USB mouse to one of the USB ports labelled **Mouse / Backup**, and connect a monitor using the included HDMI cable. See the included **Quick Reference Guide** for details.

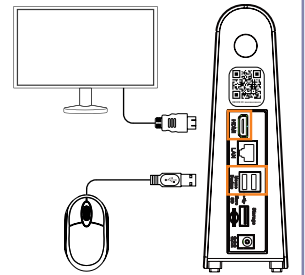

## Package Contents

\* Per camera in multi-camera packs

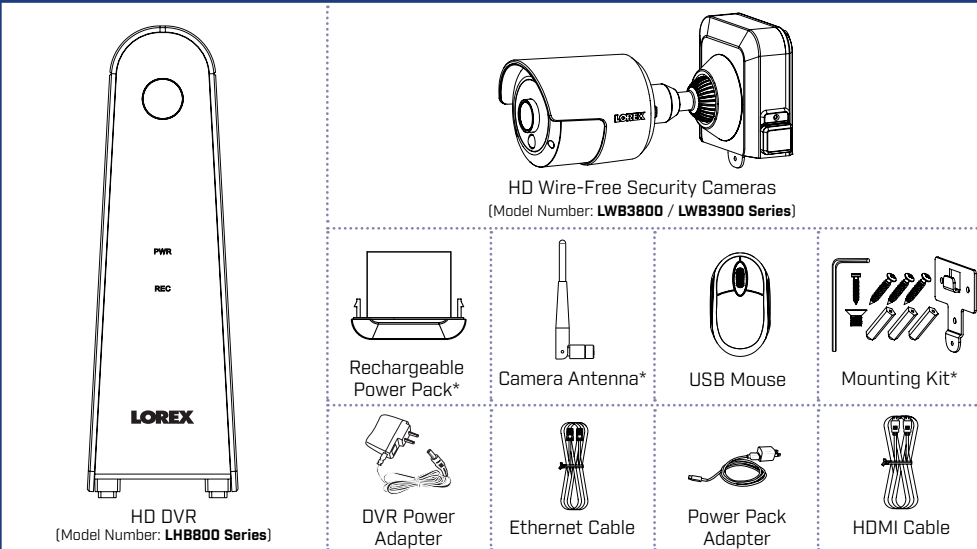

## STEP 1: Initial Setup

Before you begin, you will need to prepare the wire-free cameras and power packs.

**NOTE:** Power packs come fully charged with no need for initial charging.

### To prepare the cameras and receiver:

1. Peel off the **PLEASE REMOVE** label covering the contacts on each power pack. Insert the charged power packs into each camera base. Push up until the power pack 'clicks' firmly into place.

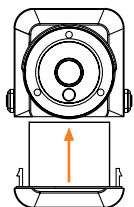

2. Twist the adjustment ring near the camera base counterclockwise to loosen and reposition each camera as shown to the right. Connect one of the white antennas to each camera.

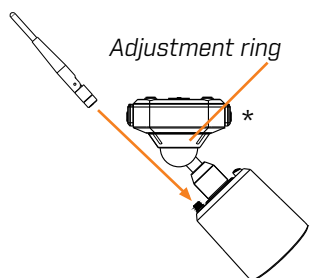

\* Top view

## STEP 3: Connecting with Lorex Secure

Connect to your system using the free Lorex Secure app for smartphones and tablets (iOS and Android).

### To connect with Lorex Secure:

1. Download and install the free **Lorex Secure** app from the App Store or Google Play Store.
2. Tap the Lorex Secure icon to launch the app.
3. Tap **SIGN UP**. Enter your email address and password to create a new account.



**NOTE:** If this is not the first device on your account, log in using your email address and password, then tap **LOG IN**. Tap **+** and then **Security System**. Proceed to step 6.

4. Tap **ADD DEVICE**.
5. Tap **Security System**.

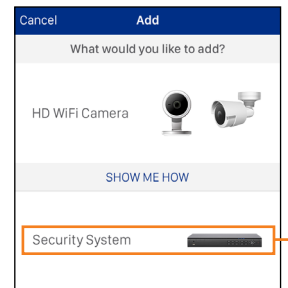
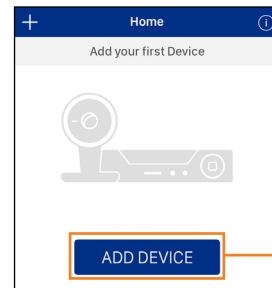

6. Scan the QR code on the back of your DVR using the camera on your smartphone or tablet.
7. Enter your DVR's user name (default: **admin**) and password (default: **00000000**). Tap **DONE**.
8. Enter a **new, secure 8-15 character password**. This password will be used to connect to your system from now on.

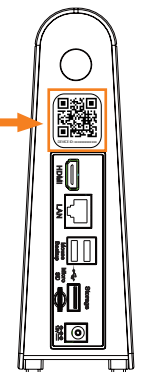

**Record your password below and store in a secure place:**

9. Your system will appear on the homescreen of the app. Tap each channel with a camera connected then tap the play button (⏮) to stream live video.

**NOTE:** If you do not see video from one or more cameras, ensure you have removed the **PLEASE REMOVE** label from the power pack. If the issue persists, see the "Troubleshooting" section on the back of this document.

10. Remove the power pack from each camera by pushing both release buttons\*, then pulling down on the power pack.

**ATTENTION:** Place your hand underneath the power pack when removing to prevent it from falling.

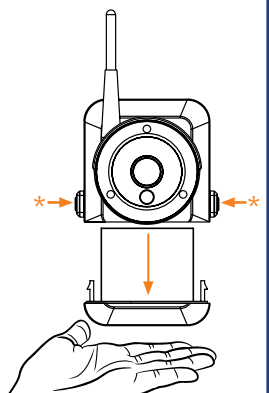

## Need Help?

Visit us online for up-to-date software and complete instruction manuals.

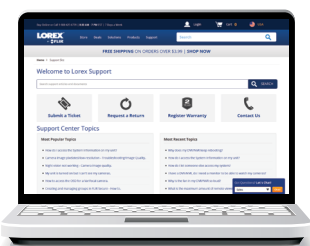

1. Visit [lorextechnology.com](http://lorextechnology.com)
2. Search for the model number of your product
3. Click on your product in the search results
4. Click on the **Downloads** tab

## Installation Tips

The wire-free cameras use a Passive InfraRed (PIR) sensor to ensure video is only recorded when motion is detected. Follow the tips below for more accurate motion detection and to optimize battery life:

- **See images to the right for ideal setup.** It is recommended to place your camera at least 7ft (2.1m) above the ground and angle it slightly downward toward the monitoring area, excluding any busy areas (e.g., sidewalks or roadways).
- Ensure the camera image is free of obstructions (i.e., tree branches).
- Position the camera no more than 20ft (6.1m) away from the area you wish to monitor.
- For best performance, position the camera so that objects of interest will move from side-to-side across the camera image, rather than moving towards or away from the camera.
- Install the camera within range of the DVR (noted in the camera's specifications).
- This camera is weather resistant for outdoor use (IP65 rated). Installation in a sheltered location is recommended.
- Battery life will vary based on temperature, settings and number of events.

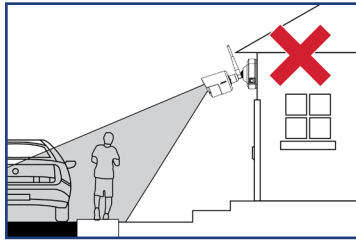
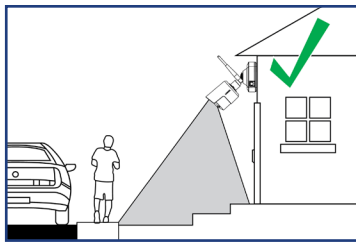

## STEP 4: Installing the Cameras

Follow the instructions below to secure the cameras. It is recommended that you refer to the "Installation Tips" section to help you select good mounting locations.

### To install your cameras:

1. Set the mounting bracket in the desired mounting position. Mark holes through the mounting bracket (shown as orange X's on the right).

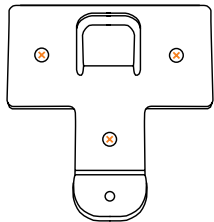

2. Drill holes where marked for the mounting screws.

3. Insert the included mounting screws (x3) into the 3 holes closest to the top of the mounting bracket. Make sure all screws are fastened tightly.

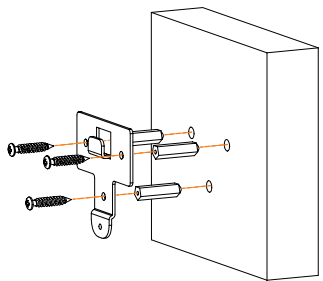

#### NOTES:

- Insert the included drywall anchors if you are mounting the camera onto drywall.
- The hole at the bottom of the mounting bracket will be used in step 5, once the camera is attached to the mounting plate.

4. Lower the camera base onto the mounting bracket so the tab in the mounting bracket locks into the slot in the camera base.

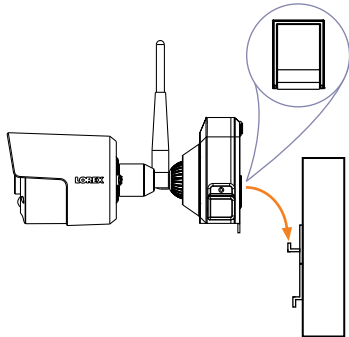

5. Insert the security screw through the fastener on the camera base to secure the camera to the mounting bracket. Tighten using the included Allen key.

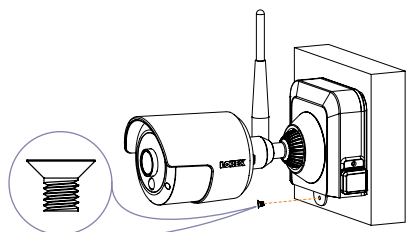

6. Insert the included power pack into the bottom of the camera base. Push up until the power pack 'clicks' into place.

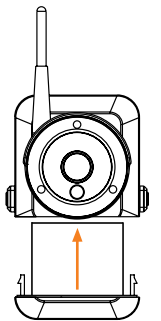

7. **OPTIONAL:** Lift up the rubber seal on the right-side release button. Insert the locking screw and tighten using the included Allen key to secure the power pack in place.

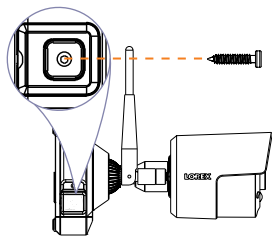

**NOTE:** You will need to loosen the locking screw to remove the power pack in the future.

8. Twist the adjustment ring near the camera base counterclockwise to loosen and reposition the camera. Hold the camera in the desired angle and tighten the adjustment ring completely to secure the camera in place.

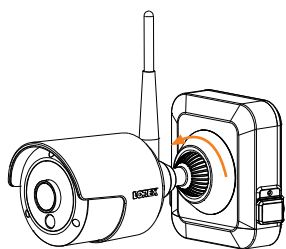

#### ATTENTION:

This camera includes an Auto Mechanical IR Cut Filter. When the camera changes between Day/Night viewing modes, an audible clicking noise may be heard from the camera. This clicking is normal, and indicates that the camera filter is working.

## Troubleshooting

Problem	Solution
No picture / signal	<ul style="list-style-type: none"> <li>• Ensure the camera is connected to a compatible DVR. For full camera compatibility, visit <a href="http://lorextechnology.com/compatibility">lorextechnology.com/compatibility</a>.</li> <li>• Ensure the power pack is properly inserted into the camera base.</li> <li>• Ensure you have removed the <b>PLEASE REMOVE</b> label from the power pack.</li> <li>• Connect the power adapter to your power pack to ensure the power pack is charged. The LED indicator on the power pack glows green for full charge, red for less than full charge.</li> <li>• Remove obstructions between the DVR and camera. Materials such as brick, concrete and wood can significantly impact the wireless signal strength.</li> <li>• Try repositioning the camera, DVR, or both to improve the reception.</li> </ul>
Battery life is too short	<ul style="list-style-type: none"> <li>• Ensure the camera is not pointing at a high-traffic area. Position the camera so it only captures areas of interest with no high-traffic areas (e.g., a busy sidewalk or roadway) visible in the image.</li> <li>• Live video is being viewed too frequently. Viewing live video often will impact battery performance.</li> <li>• Battery life will vary based on temperature, settings and number of events.</li> </ul>
Picture is dropping	<ul style="list-style-type: none"> <li>• Move the camera closer to the DVR.</li> <li>• Try repositioning the camera, DVR, or both to improve the reception.</li> </ul>
Picture is or has become choppy	<ul style="list-style-type: none"> <li>• The picture may become choppy when experiencing a lower frame rate (e.g., 6 frames per second vs. a higher 15 frames per second). This may be related to signal strength or the camera's resolution.</li> <li>• Ensure the camera resolution is set to 720p using the Lorex Secure app or the DVR.</li> <li>• Move the camera closer to the DVR.</li> <li>• Remove obstructions between the DVR and camera.</li> </ul>
Camera is not detecting motion	<ul style="list-style-type: none"> <li>• Your camera may be too far away from the area of interest. Try to keep the camera within 20ft (6.1m) of the area you want to monitor.</li> <li>• Review the "Installation Tips" section to ensure your camera is installed in an optimal location.</li> </ul>
Picture is too bright	<ul style="list-style-type: none"> <li>• Ensure your camera isn't pointed directly at a source of light (e.g., sun or spot light).</li> <li>• Move your camera to a different location.</li> </ul>
Night vision is not working	<ul style="list-style-type: none"> <li>• The night vision activates when light levels drop. The area may have too much light.</li> </ul>
Picture is not clear	<ul style="list-style-type: none"> <li>• Check the camera lens for dirt, dust, spiderwebs. Clean the lens with a soft, clean cloth.</li> </ul>
Bright spot in video when viewing at night	<ul style="list-style-type: none"> <li>• Night vision reflects when pointing a camera through a window. Move the camera to a different location.</li> </ul>

## Pairing the Camera

Your cameras should be paired to the DVR and ready to use out of the package. If a camera becomes unpaired, or if you have purchased a wire-free add-on camera (max. **6 cameras** per system), visit [lorextechnology.com/pairing/wirefree](http://lorextechnology.com/pairing/wirefree) for pairing instructions.

## Available Accessories

The following accessories are available for purchase. Visit [lorextechnology.com](http://lorextechnology.com) and search for the model numbers below for details:

Color	Wire-Free Add On Camera	Extra Power Pack Power Adapter	2-cell Accessory Power Pack	4-cell Accessory Power Pack PLUS
<b>WHITE</b>	LWB3801AC1B [US] LWB3801AC1P [EU/UK]	ACCPWRWF1	ACC2CBATT	ACC4CBATT
<b>BLACK</b>	LWB3901AC1B	ACCPWRWF1BK	ACC2CBATTBB	ACC4CBATTBB

## Charging the Power Pack

Use the included power adapter to charge the power pack. Connect the power adapter to the micro USB port on the power pack. The LED indicator on the power pack shows you the charging status (must be plugged in).

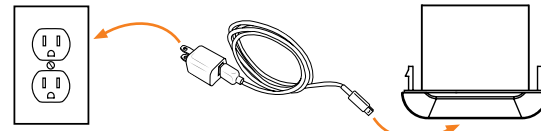

Power Pack	Charge Time
<b>2-cell</b>	Approx. 4 hours
<b>4-cell</b>	Approx. 8 hours

LED Color	Meaning
<b>Green</b>	Fully charged
<b>Red</b>	Currently charging

## Dimensions

