

User manual
用户手册

CONTENTS

EN.....	1
CH.....	9

Battery and Charging

The MOZA Mini-S has a built-in lithium battery. Fully charge the battery before the first use of Mini-S. The power indicator LED blinks when the battery level is less than 20%. Charge it in time. With universal Type-C port, Mini-S can be charged by phone charger and mobile power supplier. The charging stops automatically when the battery gets full.

Notes:

1. Please use the original charging cable provided in the package;
2. Please do not overcharge or over-discharge the battery. Otherwise the battery will be damaged;
3. Recharge and discharge the battery every 3 months to keep it activated if it is left unused for a long time.

Mini-S Overview

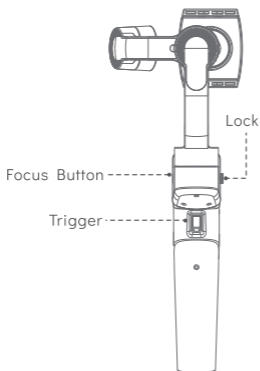
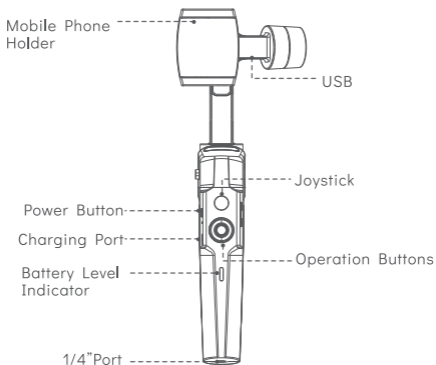

Foldable Design

- **Folded Status to Expanded Status**
Loosen the lock and rotate the gimbal 180° clockwise. Then it locks automatically.
- **Expanded Status to Folded Status**
Loosen the lock and rotate the gimbal 180° anticlockwise. Then it locks automatically.

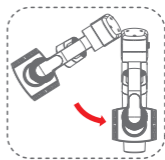

Mounting the Mobile Phone

Place the mobile phone in the phone holder with its camera facing outwards, And then level the phone.

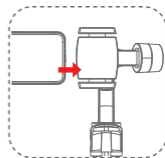

Vertical Mode (Portrait Mode)

Hold the handle and rotate the phone holder 90° clockwise to switch from horizontal mode to vertical mode.
Hold the handle and rotate the phone holder 90° anticlockwise to switch from vertical mode to horizontal mode.

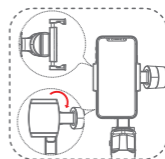

Starting Up

- Long Press Power button:
Power On/Off
- Short Press Power button Once:
Standby/Wake Up



Phone Charging

- Cable Charging

The Micro USB port on the tilt arm can be used to charge the mobile phone. (Charging cable is not included in the package.)



Phone Camera Control Cable

Phone camera control cable could help connect Mini-S with mobile phone to control internal phone camera, photo shooting and recording via some third party apps (Unsupported to some phone models and user might need to buy Type-C/Lightning adapter separately)



Download MOZA Genie App

Scan the QR code (printed at the end of this manual) or search for “MOZA Genie” in the App Store to download the MOZA Genie App. Android version: Android V5.0 and later. IOS version: IOS v9.0 and later.



1. MOZA Mini-S functions could be better performed with its customized MOZA Genie App
2. Please download the latest version. Updates are subject to change without notice.

Connecting to the MOZA Genie App

1. Power on the MOZA Mini-S.
2. Open MOZA Genie App and choose the Mini-S device. The App will enter camera interface automatically when the connection is completed.

Simplified Operation

Down Button

- Double press:
Sports Gear Mode
- Triple press:
Inception Mode

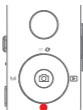

Follow Function

- Left Button

Press twice the left button: POV mode, Press twice again to stop

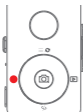

Trigger

- Double press: Re-center
- Press once+hold:
Switch to tilt follow
- Double press +hold:
Switch to All-locked



Joystick

- Move upwards: phone camera turns up
 - Move downwards: phone camera turns down
 - Move leftwards: phone camera turns left
 - Move rightwards: phone camera turns right
- The speed of camera moving increases with the larger moving range of joystick









Battery Level Indicators

- Three blue LEDs on:
70%-100% battery level
- Two blue LEDs on:
40%-70% battery level
- One blue LED on:
20%-40% battery level
- Blinking: below 20% battery level
- Solid red light: Charging
- Red light off: Charging completed



Camera Interface

	Press the center button once: start/ stop recording (only valid in video mode)
	Press twice the center button during recoring: take one photo (in video mode)
	Long press the center button:confirm to move timelapse point (in advanced timelapse mode)
	Press the top button once: open the menu
	Press twice the top button: switch to video mode/photo mode
	Long press the top button for 3s: switch to front camera/rear camera
	Press the right button once: phote playback in album Press once again to return to camera
	After the completion of timelapse points setting, long press the right button: start/stop advanced timelapse shooting (in advanced timelapse mode)
	Double press the down button: Sport gear mode
	Triple press the down button: Inception mode ($\pm 115^\circ$)
	Press twice the left button: POV mode
	Press twice again to stop
	Hold the top focus button: Focus+
	Double press the top focus button: Automatic uniform focus+
	Hold the down focus button: FocusDouble press the down focus button: Automatic uniform focus-

APP Main Features

1. Recording control
2. Object tracking
3. Timelapse
4. Quick camera adjusting
5. Follow focus & zoom
6. Gimbal Setting
7. Calibration

Menu Interface

- Press the top button once: select upwards
- Press the down button once: select downwards
- Press the left button once: enter the next level
- Press the right button once: back to the previous level

Professional Mode

After entering the function menu and selecting “professional mode”, the camera parameter setting icon will appear on the side interface. The camera shutter, iso, focus mode, exposure compensation, white balance and other parameters can be set, and the parameters can be adjusted by the button.

Firmware Upgrade

Firmware upgrade: please scan the QR code at the end of the page for details to watch the tutorial.

Calibration

The gimbal should be calibrated in the following situations:

1. Abnormal operation of the gimbal.
2. After the gimbal is started, the horizontal angle is deviated again, which cannot be solved after re-center.
3. Deviation caused by external environment while using the gimbal

More details

Scan the QR code at the end of the page to watch the tutorial.

SPEC	
Max Payload	260g
Gimbal Weight	495g
Gimbal Dimensions (mm)	Extended Dimensions:116*95*317(W*D*H) Folded Dimensions:130*68*195
Supported Phone Dimensions	58 to 88 mm
Battery Life (hrs)	8-Hours
Charging Time	1.5-Hours
Mechanical Axis Angle:	Roll axis : 315° Pan axis : 270° Tilt axis: 200°

Shooting tips

When taking extra low-angle shots, please pull the upper clip outward sufficiently (see picture below) and place the phone in slightly upward position to avoid the collision between your phone the roll arm.



If the cameras on your phone are arranged vertically, to avoid the gimbal blocking camera view, please pull the phone outward properly until there is no block on the screen (See picture below)

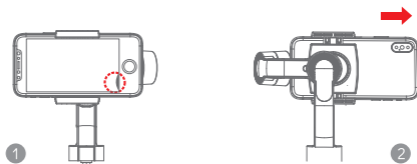

⚠ Note : Please ensure the gimbal is in power off/standby state before making the adjustments above.

Warranty Card

Model		Date of purchase	
Name		Tel	
Address			

Distributor Information (signature)

Warranty Period

Gimbal: 12 months

Gimbal Motor and battery: 3 months User manual, USB cables, storage bag and equipment shell: No warranty For more details on warranty policy: www.gudsen.com.

Warranty

1. Questions, Support, Service and Warranty please contact support@gudsen.com
2. All shipment must be approved by the Technical Support before started. Consumers are responsible for shipping costs. Technical Support will examine and identify the problem and responsibility; If the issue or issues are manufacturing defect Gudsen will cover all testing costs, material costs, labor costs, and return shipping.
3. If the product is deemed not to be covered by the warranty. We contact the customer describing the repairs and costs before repairing stabilizer. Customer is responsible for return shipping;
4. Consumers can contact support@gudsen.com for more details maintenance process.

电池及充电说明

Mini-S 使用内置锂电池，首次使用前，请先给Mini-S充满电以激活电池，保证产品顺利使用。电源指示灯开始闪烁时，说明电量不足20%，请及时充电，Mini-S使用通用Type-C接口,手机充电器、移动电源等都可以给Mini-S充电.电池在充满时将自动停止充电，请断开充电器。

注意：

1. 使用稳定器过程中，请使用包装内提供的原装充电线！
2. 切勿过充、过放电池，否则将对电芯造成损害；
3. 若长期闲置电池，请每隔3个月左右重新充放电一次以保持电池活性。

认识Mini-S

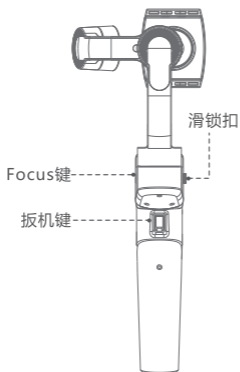
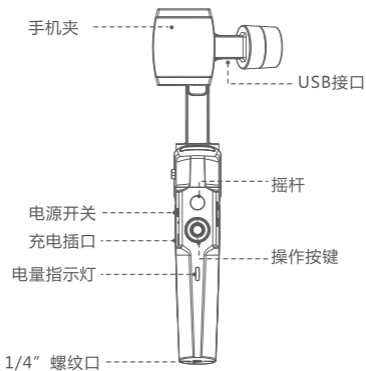

旋转折叠

- 折叠状态下
滑动安全锁扣，顺时针旋转180°，
锁扣自动锁紧。
- 展开状态下
滑动安全锁扣，逆时针旋转180°，
锁扣自动锁紧。

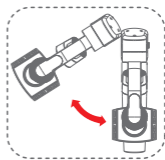

安装手机

掰开手机夹按手机镜头在前的方向，将手机滑进手机夹，使手机调平即可。

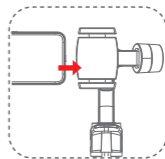

竖拍模式

需要使用竖拍模式时，正面握住手柄将手机夹顺时针旋转90°即可，
若需回到横拍模式，再将手机夹逆时针旋转90°即可。

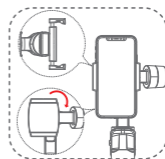

开机使用

- 长按：开机/关机
- 短按一次：待机/唤醒



手机充电

• 有线充电

在使用产品的时候，可以使用俯仰臂上的Micro USB接口，给手机充电。（充电线需另购）



手机相机控制线

手机相机控制线，可以帮助Mini-S连接手机，控制手机内置相机及部分第三方APP的拍照与录制。（少数手机设备可能不支持，Type-C/Lightning接口手机转接线需另购）



APP下载

您可以直接扫描二维码下载“MOZA精灵”（Android5.0以上、IOS9.0以上），也可以直接在手机应用商店中搜索“MOZA精灵”进行下载。（“见页尾处APP下载二维码”）



1. 配合使用专为Mini-S定制的APP“MOZA精灵”，能够让您将此款稳定器的各项功能得到更好的运用。
2. 请以最新版本APP为准；如有更新，恕不另行通知。

连接设备

1. 稳定器开机
2. 开启手机蓝牙，打开MOZA精灵App，选择所需连接的稳定器，连接成功后自动进入拍摄界面

快速动作

操作按键下键

- 双击：极速跟随
- 三击：盗梦空间

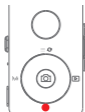

跟随功能

- 操作按键左键

双击左键打开POV模式，再次双击关闭。

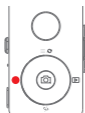

扳机键

- 双击：归中
- 单击按住：切换至俯仰跟随
- 双击按住：切换至全锁定



摇杆使用

- 向上拨：手机镜头向上转
 - 向下拨：手机镜头向下转
 - 向左拨：手机镜头向左转
 - 向右拨：手机镜头向右转
- 拨动的速度越大转速越快

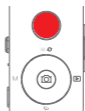

电量查看

电量指示灯

- 指示灯满格：电量70%--100%
- 指示灯两格：电量40%--70%
- 指示灯一格：电量20%--40%
- 指示灯闪烁：电量20%以下
- 红灯长亮：充电中
- 红灯熄灭：充电完成



拍照摄像

	相机界面单击中键：开始/停止录制仅在摄像模式下有效，拍照模式无效
	摄像模式录制中双击中键：拍摄一张照片
	高级延时摄影模式中长按中键：确认移动延时摄影点
	相机界面单击上键：打开界面菜单
	相机界面双击上键：拍照模式/摄影模式。
	相机界面长按3S上键：切换前后摄像头
	相机界面单击右键：进入相册回看照片 结束回看后，单击右键回到相机。
	高级延时摄影模式下，选取延时摄影点后，长按右键：启动/关闭高级延时拍摄
	相机界面双击下键：急速跟随模式。
	相机界面三击下键：进入盗梦空间（±115°）模式。
	双击左键打开POV模式，再次双击关闭。
	Focus键上键按住：Focus+
	Focus键上键双击：自动匀速Focus+
	Focus键下键按住：Focus-
	Focus键下键双击：自动匀速Focus-

主要功能介绍

1. 控制相机录制拍照
2. 物体跟踪
3. 延时摄影
4. 便捷调整相机参数
5. 控制相机跟焦变焦
6. 稳定器参数设置
7. 稳定器校准

功能菜单

- 菜单界面单击上键：向上选择
- 菜单界面单击下键：向下选择
- 菜单界面单击左键：进入下一级
- 菜单界面单击右键：退回上一级
- 菜单界面单击中键：确定选择

专业模式

进入功能菜单，选择“专业模式”后，界面会出现相机参数设置图标。可以设置相机的快门、ISO、对焦方式、曝光补偿、白平衡等参数，用按键即可调整参数。

固件升级

固件升级方法：详情请扫页尾处二维码观看教程。

稳定器校准

稳定器出现以下情况需校准：

1. 设备工作异常；
2. 稳定器启动后水平角度上有偏差，一键归中后仍然无法解决；
3. 稳定器使用环境引起的偏差。

校准方法：详情请扫页尾处二维码观看教程

云台规格	
载重	260g
重量	495g
尺寸(mm)	展开尺寸：116*95*317(L*W*H)
	折叠尺寸：130*68*195
支持手机尺寸	58 to 88 mm
电池续航时间	8(小时)
充电时间	1.5(小时)
机械角	航向：270°
	横滚：315°
	俯仰：200°

拍摄提示

如遇图1所示需超过180°低机位拍摄情形，导致手机与横滚臂碰撞，请如图2，将手机夹上端拔出较多空间，将手机放置手机夹偏上端位置。



如遇手机为广角镜头时，如图1所示拍摄时稳定器有遮挡，请如图2，将手机向手机镜头方向移动调整，调整手机直至手机屏幕内无遮挡。

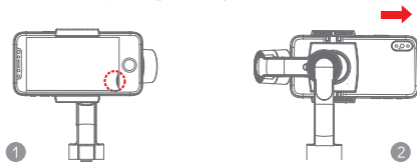

⚠ 注意：以上调整均请在关机/待机情况下操作

产品保修卡

产品型号		购买日期	
姓名		电话	
地址			

经销商信息（签章）

产品保修条例

保修期

自购机日起，云台主体保修12个月；云台电机、智能电池保修3个月。设备外壳、说明书、USB线材、包装等不在“一年免费保修服务”范围内，您可以选择有偿服务。

七日内免费退货

自购机日起7日内，根据国家最新三包规定，您可以选择退货（按票面金额一次性退清货款）、换货（更换同型号同规格的产品）或修理。

八至十五日免费换货或修理

自购机日起第8日至第15日内，主机出现性能故障，并经特约维修中心检测，确认非人为损坏的本身质量问题，您可以选择换货（更换同型号、同规格产品）或修理；但是更换的范围，只限于产品主机，其他配件无质量问题，不能更换；购买者在以下条件下不享受免费保修服务，您可以选择有偿服务。

1. 超过三包有效期的；
2. 无三包凭证及有效发货票的，但能够证明该产品在三包有效期内的除外；
3. 包修凭证上的型号与修理产品型号不符或者涂改的；
4. 非本公司特约维修人员拆动造成损坏的；
5. 因不可抗力造成损坏的；
6. 未按产品使用说明书要求使用、维护、保养而造成损坏的。

Contacts/联络卡



Official Website
官网



Sina Weibo
新浪微博



WeChat
微信



Instagram



Twitter



Facebook



YouTube



国内用户建议表

MOZA Genie Download/MOZA Genie下载



IOS



Android

Tutorial/教程



Firmware Upgrade
and Calibration
YouTube QR
固件升级及校准教程
“YouTube二维码”



Firmware Upgrade
and Calibration
WeChat QR
固件升级及校准教程
“微信二维码”

合格证

出厂日期: _____

质检员: _____

GUDSEN

INVENTED FOR VIDEO

Gudsen Technology Co., Ltd

Web: www.gudsen.com