

# Canon EFS LENS

## EF-S55-250mm f/4-5.6 IS II



**IMAGE STABILIZER**

**ENG**

Instructions

# Thank you for purchasing a Canon product.

The Canon EF-S55-250mm f/4-5.6 IS II lens is a high-performance telephoto zoom lens equipped with an Image Stabilizer, and has been developed for digital SLRs compatible with EF-S lenses\*.

It is equipped with an Image Stabilizer effective for hand-held shooting at slow shutter speeds.

\* Only the following EOS cameras are compatible with EF-S lenses (as of May 2014):  
EOS 7D, EOS 70D, EOS 60D, EOS 60Da, EOS 50D, EOS 40D, EOS 30D, EOS 20D, EOS 20Da, EOS REBEL T5i/700D, EOS REBEL SL1/100D, EOS REBEL T4i/650D, EOS REBEL T3i/600D, EOS REBEL T2i/550D, EOS REBEL T1i/500D, EOS REBEL XSi/450D, EOS REBEL T5/1200D, EOS REBEL T3/1100D, EOS REBEL XS/1000D, EOS DIGITAL REBEL XTi/400D DIGITAL, EOS DIGITAL REBEL XT/350D DIGITAL, EOS DIGITAL REBEL/300D DIGITAL  
EOS M2\*1 and EOS M when used together with Mount Adapter EF-EOS M

- “IS” stands for Image Stabilizer.

## Features

1. The Image Stabilizer gives the equivalent effect of a shutter speed four stops faster\*2. This function provides optimal image stabilization depending on shooting conditions (such as shooting still subjects and following shots).
2. UD lens elements for excellent imaging performance.
3. Great close-ups at 1.1 m/3.6 ft at all focal lengths.
4. A truly round aperture hole results in a nicer background blur.

\*1: Not available in certain countries and regions.

\*2: Based on  $[1/(\text{focal length} \times 1.6)]$  second. Generally, it requires a shutter speed  $[1/\text{focal length}]$  second or faster to prevent camera shake (in 35mm format. With an EF-S lens, it would be  $[1/(\text{focal length} \times 1.6)]$  second).

## Conventions used in this instruction



Warning to prevent lens or camera malfunction or damage.



Supplementary notes on using the lens and taking pictures.

### **Safety Precautions**

- **Do not look at the sun or a bright light source through the lens or camera.** Doing so could result in loss of vision. Looking at the sun directly through the lens is especially hazardous.
- **Whether it is attached to the camera or not, do not leave the lens under the sun without the lens cap attached.** This is to prevent the lens from concentrating the sun's rays, which could cause a fire.

### **Handling Cautions**

- **If the lens is taken from a cold environment into a warm one, condensation may develop on the lens surface and internal parts.** To prevent condensation in this case, first put the lens into an airtight plastic bag before taking it from a cold to warm environment. Then take out the lens after it has warmed gradually. Do the same when taking the lens from a warm environment into a cold one.
- Do not leave the lens in excessive heat such as in a car in direct sunlight. **High temperatures can cause the lens to malfunction.**

This device complies with Part 15 of the FCC Rules. Operation is subject to the following two conditions: (1) This device may not cause harmful interference, and (2) this device must accept any interference received, including interference that may cause undesired operation.

Do not make any changes or modifications to the equipment unless otherwise specified in the instructions. If such changes or modifications should be made, you could be required to stop operation of the equipment.

This equipment has been tested and found to comply with the limits for a class B digital device, pursuant to part 15 of the FCC Rules. These limits are designed to provide reasonable protection against harmful interference in a residential installation. This equipment generates, uses and can radiate radio frequency energy and, if not installed and used in accordance with the instructions, may cause harmful interference to radio communications.

However, there is no guarantee that interference will not occur in a particular installation. If this equipment does cause harmful interference to radio or television reception, which can be determined by turning the equipment off and on, the user is encouraged to try to correct the interference by one or more of the following measures:

- Reorient or relocate the receiving antenna.
- Increase the separation between the equipment and receiver.
- Connect the equipment into an outlet on a circuit different from that to which the receiver is connected.
- Consult the dealer or an experienced radio/TV technician for help.

---

CAN ICES-3 (B) / NMB-3 (B)

---

## Nomenclature

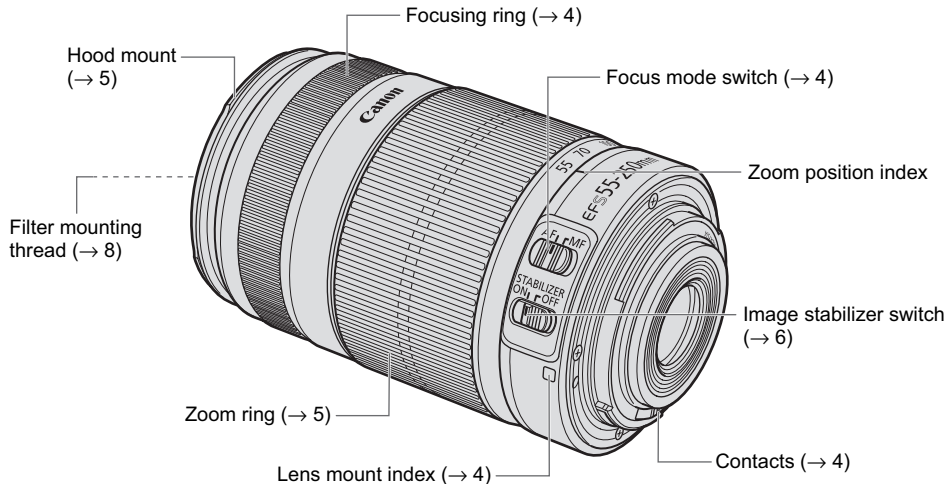

For detailed information, reference page numbers are provided in parentheses (→ \*\*).

## 1 Mounting and Detaching the Lens

See your camera's instructions for details on mounting and detaching the lens.

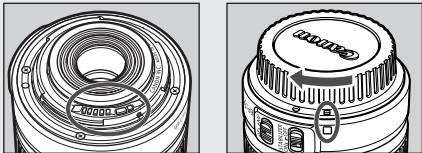

- After detaching the lens, place the lens with the rear end up to prevent the lens surface and electrical contacts from getting scratched.
- If the contacts get soiled, scratched, or have fingerprints on them, corrosion or faulty connections can result. The camera and lens may not operate properly.
- If the contacts get soiled or have fingerprints on them, clean them with a soft cloth.
- If you remove the lens, cover it with the dust cap. To attach it properly, align the lens mount index and the □ index of the dust cap as shown in the diagram, and turn clockwise. To remove it, reverse the order.

## 2 Setting the Focus Mode

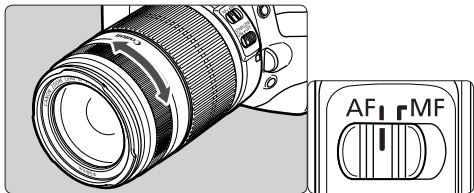

To shoot in autofocus mode, set the focus mode switch to AF.

To use only manual focusing, set the focus mode switch to MF, and focus by turning the focusing ring.



- Do not touch the rotating parts of the lens while autofocus is active.
- Do not adjust focus manually when the focus mode switch is set to AF.

### 3 Zooming

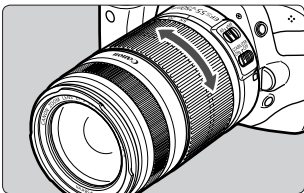

To zoom, turn the lens' zoom ring.

- ⚠ Be sure to finish zooming before focusing. Changing the zoom ring after focusing can affect the focus.

### 4 Hood (Sold Separately)

The ET-60 hood can keep unwanted light out of the lens, and also protects the lens from rain, snow, and dust.

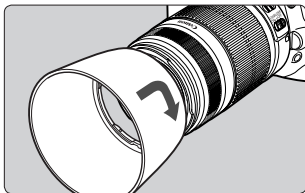

Turn the hood in the direction of the arrow to attach it securely. The hood can be reverse-mounted on the lens for storage.

- ⚠
  - When attaching or detaching the hood, grasp the base of the hood to turn it. To prevent deformation, do not grasp the rim of the hood to turn it.
  - Part of the picture may be blocked if the hood is not attached properly.

## 5 Image Stabilizer

You can use the image stabilizer in AF or MF mode.

This function provides optimal image stabilization depending on shooting conditions (such as shooting still subjects and following shots).

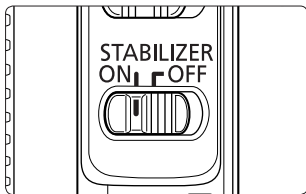

### 1 Set the **STABILIZER** switch to **ON**.

- If you are not going to use the image stabilizer function, set the switch to **OFF**.

### 2 When you press the shutter button halfway, the Image Stabilizer will start operating.

- Make sure the image in the viewfinder is stable, then press the shutter button the rest of the way down to take the picture.



- The Image Stabilizer cannot compensate for a blurred shot caused by a subject that moved.
- The Image Stabilizer may not be fully effective if you shoot from a violently shaking vehicle or other transportation.
- The Image Stabilizer consumes more power than normal shooting, resulting in fewer shots and a shorter movie shooting time.



- When shooting a still subject, it compensates for camera shake in all directions.
- It compensates for vertical camera shake during following shots in a horizontal direction, and compensates for horizontal camera shake during following shots in a vertical direction.
- When you use a tripod, the Image Stabilizer should be turned off to save battery power.
- Even with a monopod, the Image Stabilizer will be as effective as during hand-held shooting. However, depending on the shooting environment, the Image Stabilizer effect may be less effective.
- The image stabilizer function also operates when the lens is used with an Extension Tube EF12 II or EF25 II.
- If you set the camera's Custom Function to change the assigned button to operate the AF, the Image Stabilizer will operate when you press the newly assigned AF button.

## Image Stabilizer

---

The image stabilizer in this lens is effective for hand-held shots under the following conditions.

- In semi-darkened areas such as indoors or outdoors at night.
- In locations where flash photography is prohibited, such as art museums and theater stages.
- In situations where your footing is uncertain.
- In situations where fast shutter settings cannot be used.
- When panning subjects in motion.

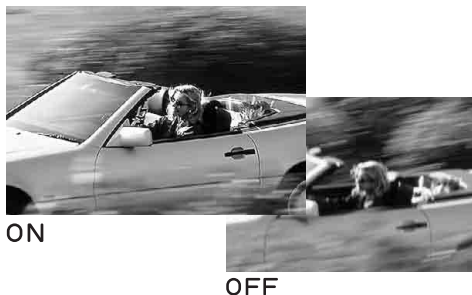



## 6 Filters (Sold Separately)

You can attach filters to the filter mounting thread on the front of the lens.



- The front end of the lens rotates, so hold it when attaching the filter.
- Use a genuine Canon filter (58mm).
- To adjust the polarizing filter, first remove the lens hood.

## 7 Extension Tubes (Sold Separately)

You can attach Extension Tube EF12 II or EF25 II for magnified shots. The shooting distance and magnification are shown below.

		Camera-to-Subject Distance (mm)		Magnification	
		Near	Far	Near	Far
EF12 II	55mm	407	411	0.25×	0.22×
	250mm	1006	5274	0.38×	0.05×
EF25 II	55mm	297	281	0.47×	0.48×
	250mm	934	2692	0.46×	0.11×



Manual focusing is recommended for accurate focusing.

## 8 Close-up Lenses (Sold separately)

---

Attaching a 250D or 500D (58mm) Close-up Lens enables close-up photography. The magnification will be as follows.

- Close-up Lens 250D: 0.23x - 1.42x
- Close-up Lens 500D: 0.11x - 0.86x



Manual focusing is recommended for accurate focusing.

## 9 Specifications

<b>Image Size</b>	15.1 × 22.7 mm
<b>Focal Length/Aperture</b>	55 – 250 mm f/4 – 5.6
<b>Lens Construction</b>	10 groups, 12 elements
<b>Minimum Aperture</b>	f/22 – 32
<b>Angle of View</b>	Diagonal: 27° 50' – 6° 15' Vertical: 15° 40' – 3° 30' Horizontal: 23° 20' – 5° 20'
<b>Min. Focusing Distance</b>	1.1 m/3.6 ft.
<b>Max. Magnification</b>	0.31 × (at 250 mm)
<b>Field of View</b>	218 × 328 – 49 × 73 mm/8.6 × 12.9 – 1.9 × 2.9 inch (at 1.1 m)
<b>Filter Diameter</b>	58 mm
<b>Max. Diameter and Length</b>	70 × 108 mm/2.8 × 4.3 inch
<b>Weight</b>	approx. 390 g/13.8 oz
<b>Hood</b>	ET-60 (Sold separately)
<b>Lens Cap</b>	E-58/E-58 II
<b>Case</b>	LP1019 (Sold separately)

- Equivalent to 88-400 mm in the 35 mm film format.
- The lens length is measured from the mount surface to the front end of the lens. Add 21.5 mm to include the E-58 lens cap and dust cap, and 24.2 mm for the E-58 II.
- The size and weight listed are for the lens only, except as indicated.
- Aperture settings are specified on the camera. The camera automatically compensates for variations in the aperture setting when the camera is zoomed in or out.
- The EF1.4X III/EF2X III extenders cannot be used with this lens.
- All data listed is measured according to Canon standards.
- Product specifications and appearance are subject to change without notice.

**Canon**