

Mobile Broadband Router  
Airplay



N<sup>+</sup> Server Router Mini - All Broadbands  
GR-1142

**User Manual V 1.0**



# Table of Contents

Table of Contents .....	2
Chapter 1 Introduction.....	7
1.1 Hardware Features .....	7
1.2 Product Appearance.....	8
Chapter 2 System and Network Setup .....	10
2.1 Build Network Connection .....	10
2.1.1 Router Mode .....	10
2.1.2 AP Mode .....	11
2.1.3 Wi-Fi AP Mode .....	11
2.2 Connecting SAPIDO GR-1142.....	11
2.3 Network setup.....	12
2.3.1 Windows 2000 .....	13
2.3.2 Windows XP.....	14
2.3.3 Windows Vista / Windows 7.....	15
2.4 Router IP Address Lookup .....	16
2.4.1 Log into Web GUI .....	17
Chapter 3 Internet Connection .....	19
3.1 Plug and Play.....	19
3.1.1 Smart Phone /iPhone Internet sharing plug and play .....	19
3.2 Router Mode- Using as a broadband router .....	21
3.2.1 One button setup.....	21
3.2.2 Parental Control .....	22
3.2.2.1 URL Filtering .....	22
3.2.2.2 Mac Filter Schedule.....	23
3.2.2.3 Schedule.....	23
3.2.3 AirCloud Monitor.....	24
3.2.3.1 WebCam Server1.....	24
3.2.3.2 WebCam Server2.....	24
3.2.4 AirCloud Storage .....	26
3.2.4.1 FTP server .....	26
3.2.4.2 Samba management .....	27
3.2.5 WAN Interface- Ethernet Port .....	27
3.2.5.1 Static IP .....	28
3.2.5.2 DHCP Client.....	29
3.2.5.3 PPPoE .....	30
3.2.5.4 PPTP .....	32
3.2.5.5 L2TP.....	33

3.2.5.6	Advance function .....	34
3.2.6	WAN Interface- 3G USB dongle .....	34
3.2.7	WAN Interface- Wireless.....	36
3.3	AP Mode-Using as a Access Point .....	38
3.4	WiFi AP Mode- Using as a Network Converter.....	39
Chapter 4	Wireless Setup .....	42
4.1	Wireless Setup .....	42
4.1.1	Setup Wireless LAN by WPS button.....	42
4.1.2	Wireless Basic Setup from Web GUI .....	45
4.1.2.1	Multiple APs .....	47
4.1.2.2	Enable Universal Repeater Mode .....	48
4.2	Wireless Security Setup .....	49
4.3	Wireless Access Control.....	52
Chapter 5	Router Mode Security Setup .....	55
5.1	NAT .....	55
5.1.1	Virtual Server .....	55
5.1.2	Virtual DMZ .....	56
5.2	Firewall.....	57
5.2.1	QoS.....	57
5.2.2	Port Filtering.....	58
5.2.3	IP Filtering .....	59
Chapter 6	Advanced Setup.....	61
6.1	Dynamic DNS Setting <b>Router</b> .....	61
6.2	Wireless Advanced Setup.....	62
6.2.1	Wireless Site Survey <b>WiFi-AP</b> .....	64
6.2.2	WDS Settings <b>Router</b> <b>AP</b> .....	64
6.2.3	WPS <b>Router</b> <b>AP</b> .....	68
6.3	System Management .....	71
6.3.1	Walk on LAN Schedule .....	71
6.3.2	Change Password.....	72
6.3.3	Firmware Upgrade .....	73
6.3.4	Profile Save.....	73
6.3.5	Remote Manager .....	76
6.3.6	Time Zone Setting.....	77
6.3.7	UPnP Setting .....	77
6.3.8	VPN Passthrough Setting.....	78
6.3.9	Language Setting .....	79
6.4	Log & Status .....	79

6.4.1	Network Config.....	80
6.4.2	Event Log .....	81
6.5	Logout	82
<b>Chapter 7</b>	<b>Samba Server .....</b>	<b>83</b>
7.1	How to use SAPIDO GR-1142 as a Samba server .....	83
7.2	Air play .....	83
7.3	Printer Server .....	85
	To add an LPR port .....	85
<b>Chapter 8</b>	<b>DDNS Service Application .....</b>	<b>87</b>
<b>Chapter 9</b>	<b>Q &amp; A.....</b>	<b>92</b>
9.1	Installation .....	92
9.2	LED .....	92
9.3	IP Address .....	92
9.4	OS Setting .....	93
9.5	SAPIDO GR-1142 Setup.....	95
9.6	Wireless LAN.....	96
9.7	Support.....	98
9.8	Others.....	99
9.9	USB Device.....	99
<b>Chapter 10</b>	<b>Appendices .....</b>	<b>100</b>
10.1	Operating Systems .....	100
10.2	Browsers.....	100
10.3	Communications Regulation Information .....	100

## FCC Statement



Federal Communication Commission Interference Statement This equipment has been tested and found to comply with the limits for a Class B digital device, pursuant to Part 15 of the FCC Rules.

These limits are designed to provide reasonable protection against harmful interference in a residential installation. This equipment generates, uses and can radiate radio frequency energy and, if not installed and used in accordance with the instructions, may cause harmful interference to radio communications. However, there is no guarantee that interference will not occur in a particular installation. If this equipment does cause harmful interference to radio or television reception, which can be determined by turning the equipment off and on, the user is encouraged to try to correct the interference by one of the following measures:

- Reorient or relocate the receiving antenna.
- Increase the separation between the equipment and receiver.
- Connect the equipment into an outlet on a circuit different from that to which the receiver is connected.
- Consult the dealer or an experienced radio/TV technician for help.

## FCC Caution

1. The device complies with Part 15 of the FCC rules. Operation is subject to the following conditions:
2. This device may not cause harmful interference, and this device must accept any interference received, including interference that may cause undesired operation.
3. FCC RF Radiation Exposure Statement: The equipment complies with FCC RF radiation exposure limits set forth for an uncontrolled environment. This equipment should be installed and operated with a minimum distance of 20 centimeters between the radiator and your body.
4. This Transmitter must not be co-located or operating in conjunction with any other antenna or transmitter.
5. Changes or modifications to this unit not expressly approved by the party responsible for compliance could void the user authority to operate the equipment.

## IMPORTANT NOTE

FCC Radiation Exposure Statement:

This equipment complies with FCC radiation exposure limits set forth for an uncontrolled environment. This equipment should be installed and operated with minimum distance 20cm between the radiator & your body.

## CE Mark Warning



This is a class B product. In a domestic environment, this product may cause radio interference, in which case the user may be required to take adequate measures.

## National Restrictions

Frequency range - 2400.0 - 2483.5 MHz

Country	Country	Reason/remark
Bulgaria	none	General authorization required for outdoor use and public service.
France	Outdoor use limited to 10 mW e.i.r.p. within the band 2454-2483.5 MHz	Military Radiolocation use. Refarming of the 2.4 GHz band has been ongoing in recent years to allow current relaxed regulation. Full implementation planned 2012.
Italy	none	If used outside of own premises, general authorization is required.
Luxembourg	none	General authorization required for network and service supply (not for spectrum).
Norway	Implemented	This subsection does not apply for the geographical area within a radius of 20 km from the centre of Ny-Ålesund.
Russian Federation	none	Only for indoor applications.

Note: Please don't use the product outdoors in France

## CE Statement of Conformity

Our product has been tested in typical configuration by Ecom Sertech Corp and was found to comply with the essential requirement of "Council Directive on the Approximation of the Laws of the Member States relating to Electromagnetic Compatibility" (89/336/EEC; 92/31/EEC; 93/68/EEC). The Declaration of Conformity can be found at the Sapido regional website.

[www.sapidotech.de](http://www.sapidotech.de)

## CE Information of Disposal



This electric and electronic equipment or unit which is labeled with crossed-out wheeled bin may not be disposed of with household waste. This mark is based on European Directive 2002/96/EC (for Waste Electric and Electronic Equipment=WEEE).

Please take it to the designated collection facilities. We will ensure the proper recycling, reuse and other forms of recovery of WEEE. WEEE has the potential effects on the environment and human health as a result of the presence of hazardous substances. You can contribute to eliminate these effects by your cooperation.

# Chapter 1 Introduction

## 1.1 Hardware Features

Item	Specification
<b>Key Components</b>	
<b>Main Processor</b>	Realtek RTL8196C (400MHz )
<b>Flash</b>	8Mbytes Serial Flash
<b>RAM</b>	32Mbytes SDRAM
<b>Wireless Chip</b>	Realtek RTL8192CE (MAC+BB+RF) 2T2R
<b>Communication Interfaces</b>	
<b>WAN Port</b>	1 x 10/100 Mbps RJ45, with auto MDI/MDIX
<b>LAN Port</b>	1 x 10/100 Mbps RJ45, with auto MDI/MDIX
<b>USB Port</b>	2 x USB2.0 host interface for 3.5G USB dongle, USB printer, USB flash/hard disk and web camera.
<b>Wireless</b>	IEEE 802.11b/g/n
<b>Others</b>	
<b>Wireless Antenna</b>	Internal x2
<b>Transmission Power</b>	802.11b: 19±2dBm @ normal temp. range 802.11g: 16±2dBm @ normal temp. range 802.11n (20MHz/40MHz): 14±2dBm @ normal temp. range
<b>Receive Sensitivity</b>	11Mbps : TYP. -83dBm @ 8% PER 54Mbps: TYP. -70dBm @ 10% PER 11n (20MHz): TYP. -64dBm @ 10% PER 11n (40MHz): TYP. -61dBm @ 10% PER
<b>Slide Switch</b>	Server Router / Server AP / WiFi Server AP mode switch
<b>Button</b>	<b>Reboot button / Reset button</b> <b>WPS button</b>
<b>Power supply</b>	<ul style="list-style-type: none"> <li>• AC100V ~ 240V</li> <li>• DC5V/1.5A input for mini-USB port</li> </ul>
<b>Dimensions</b>	91mm(L) x 78mm(W) x 30mm(H)
<b>Device Weight</b>	TBD

## 1.2 Product Appearance

### λ The Front

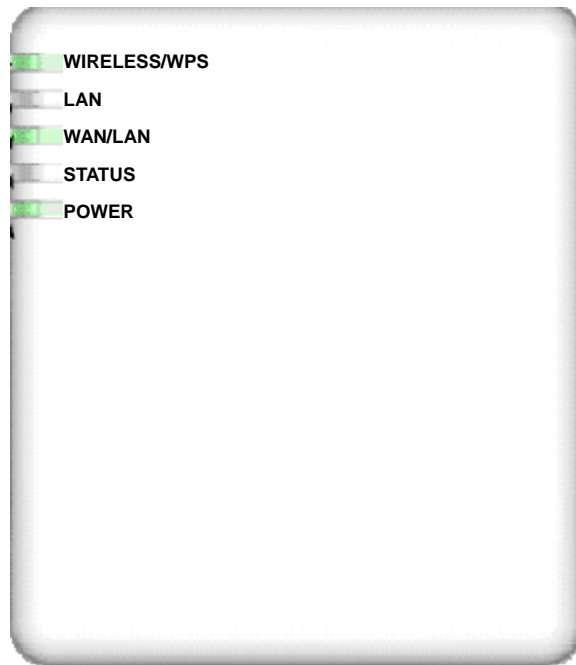

LED Indicator Status Description:

LED Indicator	Status	Solid	Flashing
<b>Power</b>		Operation OK	-
<b>Status</b>		System ready	Reset / Firmware updates in progress
<b>WAN</b>		Ethernet connected	Transmitting Data
<b>LAN</b>		Ethernet connected	Transmitting Data
<b>WIRELESS &amp; WPS</b>		Operation OK	green: Transmitting Data Orange: WPS enabled

### λ The Rear

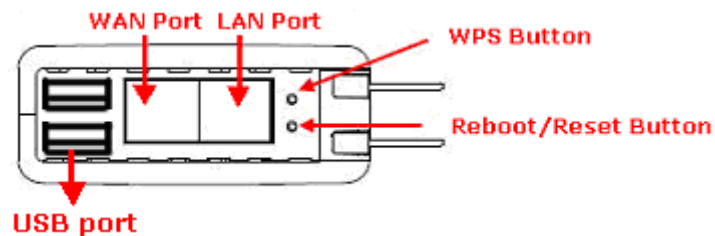

<b>Power DC Jack</b>	DC 5V power in
<b>Reset Button</b>	Press for back to factory default
<b>USB Port</b>	For 3G/USB printer、webcam、disk、speaker

<b>Ethernet Port</b>	RJ-45 Ethernet 10/100/100 Ports
<b>Ethernet Port (WAN)</b>	RJ-45 Ethernet 10/100/100 Port

## Chapter 2 System and Network Setup

The SAPIDO GR-1142 is an easy to setup and wireless device for various application and environment, especially for large installs such as hotels, offices space, warehouses, hot-spots and more.

To begin with SAPIDO GR-1142, you must have the following minimum system requirements. If your system can't correspond to the following requirements, you might get some unknown troubles on your system.

- Internet Account for XDSL/Cable Modem, or 3G.
- One Ethernet (10 BASE-T, 10/100 BASE-TX) network interface card.
- TCP/IP and at least one web browser software installed (E.g.: Internet Explorer 6.0, Netscape Navigator 7.x, Apple Safari 2.03 or higher version).
- At least one 802.11g (54Mbps) or one 802.11b (11Mbps) wireless adapter for wireless mobile clients.
- Recommended OS: WinXP, Visata or Win7 / Linux.

### 2.1 Build Network Connection

Administrator can manage the settings for WAN, LAN, Wireless Network, NTP, password, User Accounts, Firewall, etc.

Please confirm the network environment or the purpose before setting this product.

#### 2.1.1 Router Mode

Switch to router mode through web GUI when the first setup.

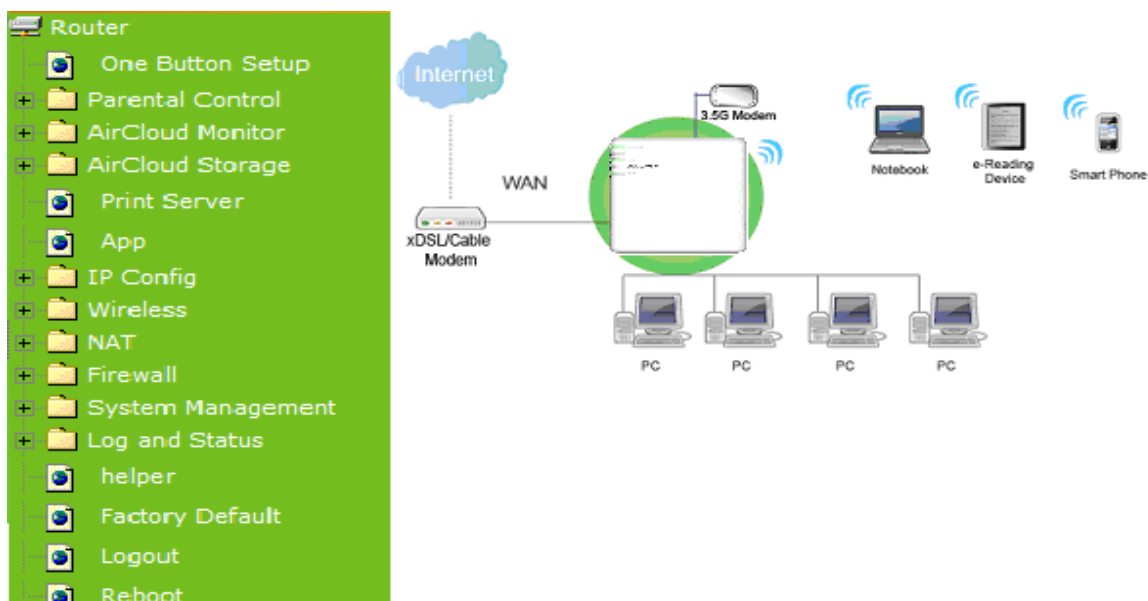

## 2.1.2 AP Mode

Switch to AP mode, if a router is already set at the house, and you want to make the wireless LAN communication.

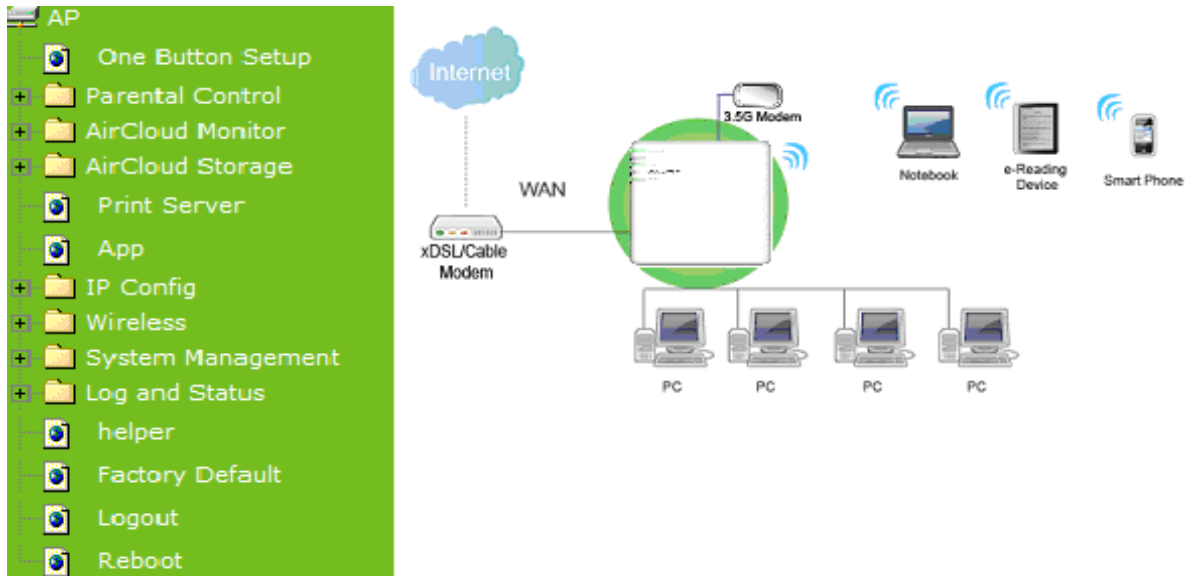

## 2.1.3 Wi-Fi AP Mode

Switch to WiFi AP Mode when you connect to the internet wirelessly through PC and wireless device without wireless LAN function equipped.

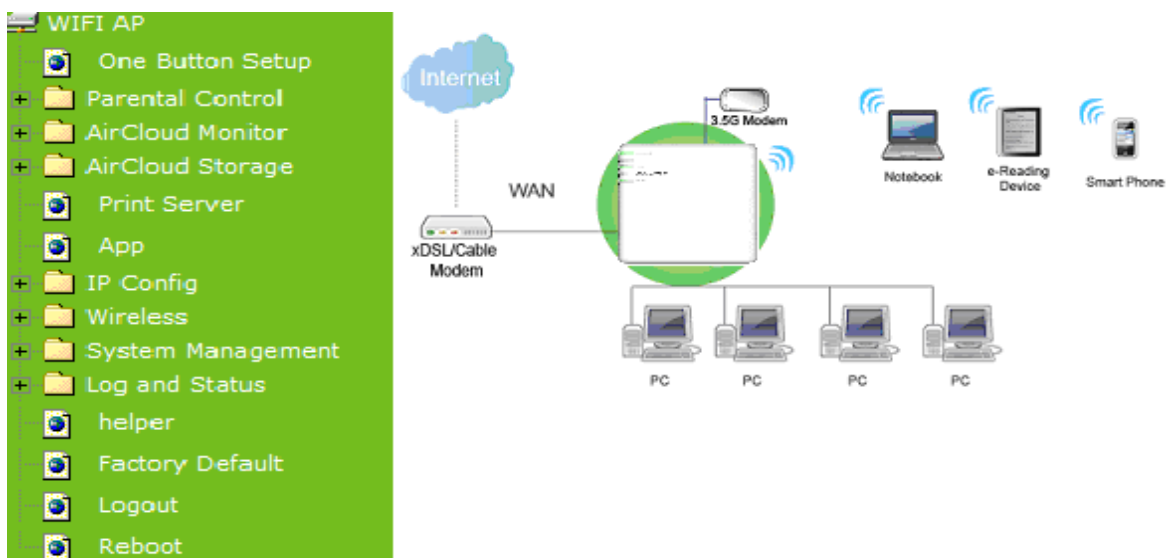

## 2.2 Connecting SAPIDO GR-1142

Prepare the followings before the connection:

- PC or Notebook for setup
- Ethernet cable or 3G modem

1. Make sure you are under "Router Mode".
2. Connect SAPIDO GR-1142 to xDSL/ Cable modem with the Ethernet cable, WAN to LAN.

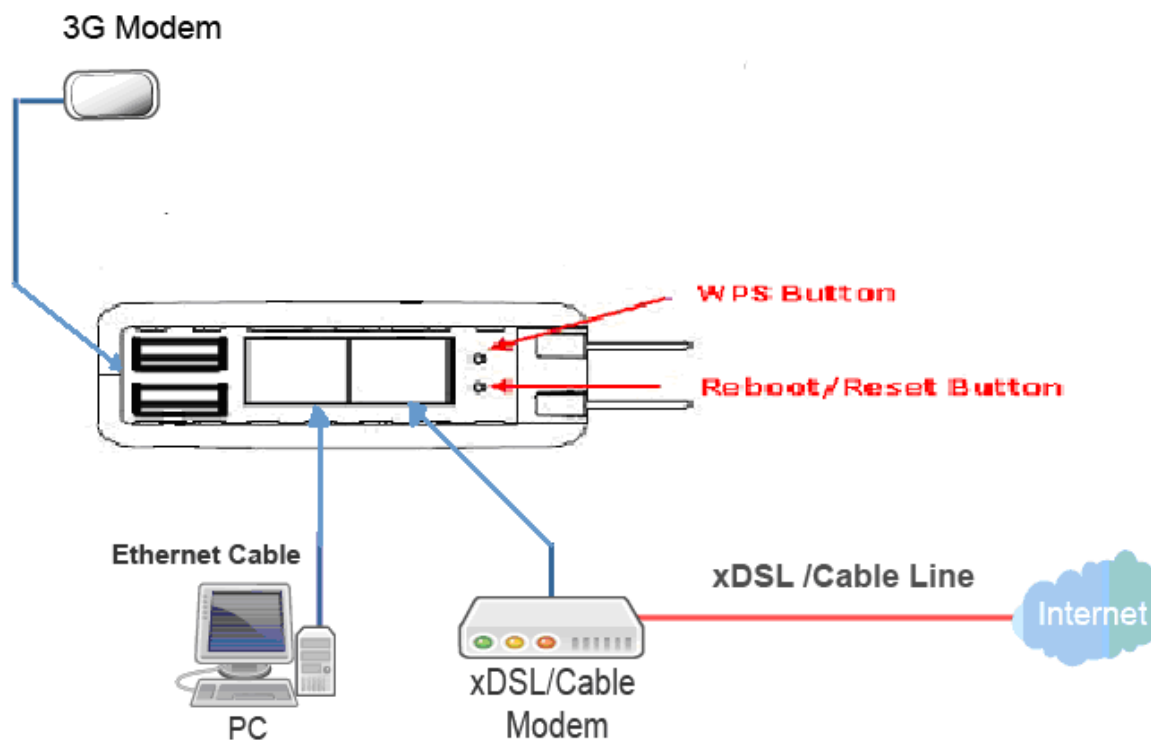

3. Turn on your Computer.



## 2.3 Network setup

After the network connection is built, the next step is setup the router with proper network parameters, so it can work properly in your network environment. Before you connect to the wireless router and start configuration procedures, your computer must be able to get an IP address from the wireless router automatically (use dynamic IP address). If it's set to use

static IP address, or you're unsure, please follow the below instructions to configure your computer with dynamic IP address:

### 2.3.1 Windows 2000

Click "Start" button (it should be located at lower-left corner of your computer), then click control panel. Double-click Network and Dial-up Connections icon, double click Local Area Connection, and Local Area Connection Properties window will appear. Select "Internet Protocol (TCP/IP)", then click "Properties".

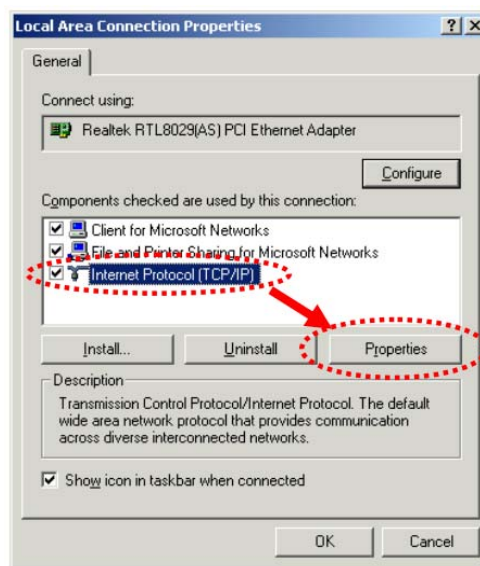

1. Select "Obtain an IP address automatically" and "Obtain DNS server address automatically", then click "OK".

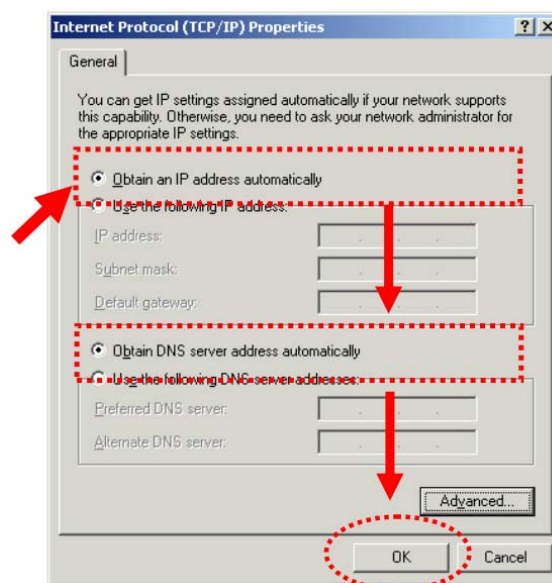

## 2.3.2 Windows XP

1. Click “Start” button (it should be located at lower-left corner of your computer), then click control panel. Double-click Network and Internet Connections icon, click Network Connections, then double-click Local Area Connection, Local Area Connection Status window will appear, and then click “Properties”.

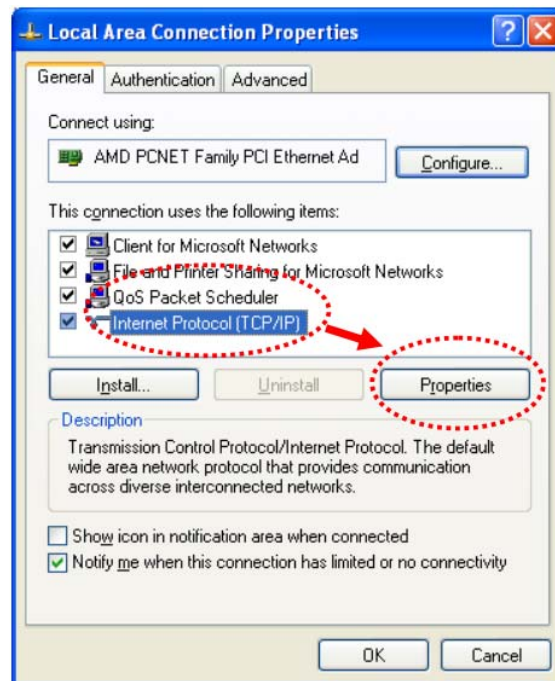

2. Select “Obtain an IP address automatically” and “Obtain DNS server address automatically”, then click “OK”.

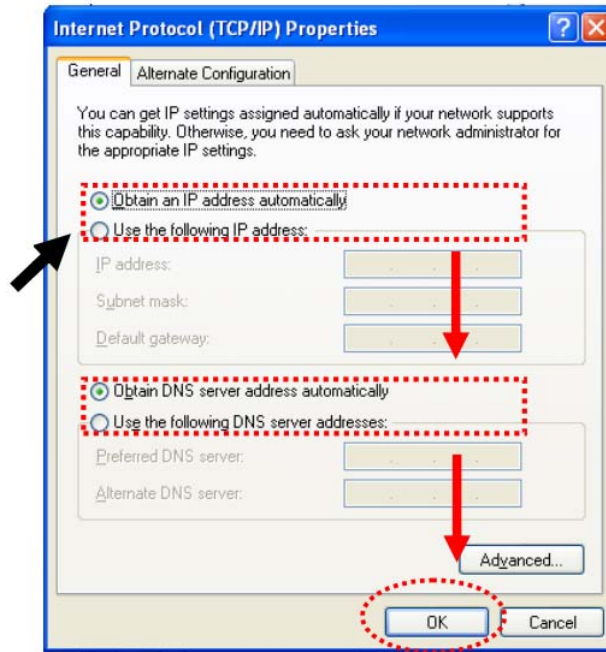

### 2.3.3 Windows Vista / Windows 7

1. Click "Start" button (it should be located at lower-left corner of your computer), then click control panel. Click View Network Status and Tasks, and then click Manage Network Connections. Right-click Local Area Network, then select "Properties". Local Area Connection Properties window will appear, select "Internet Protocol Version 4 (TCP / IPv4)", and then click "Properties".

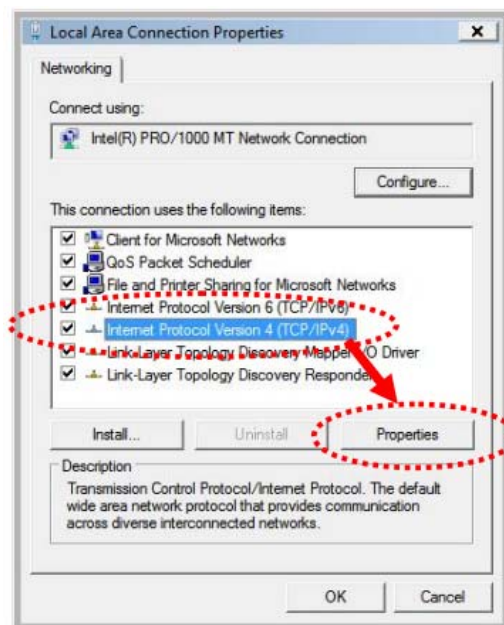

2. Select "Obtain an IP address automatically" and "Obtain DNS server address

automatically”, then click “OK”.

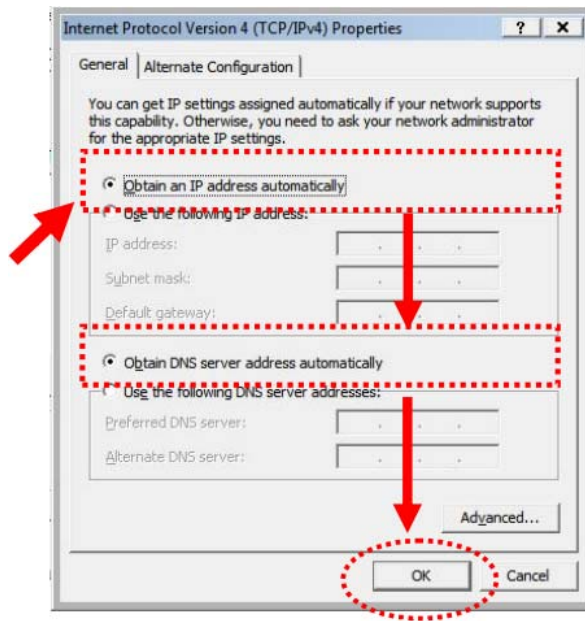

## 2.4 Router IP Address Lookup

After the IP address setup was completed, please clicks “start” → “run” at the bottom-lower corner of your desktop:

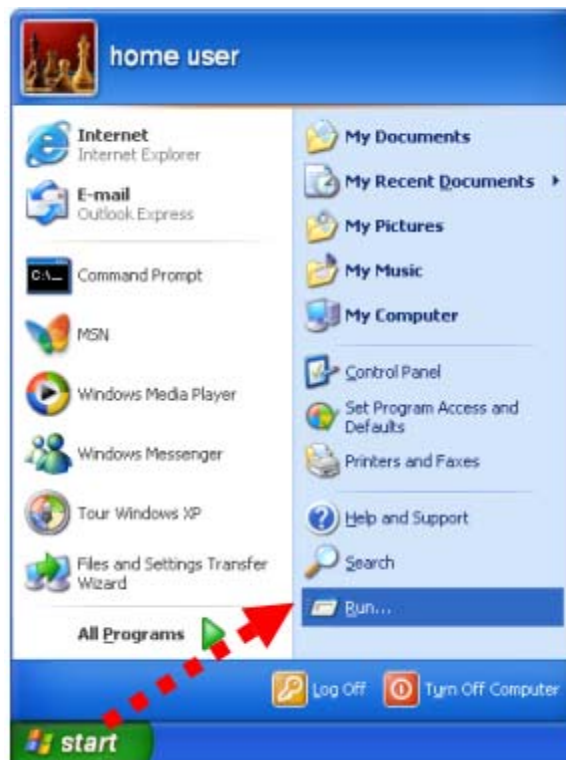

Input “cmd”, and then click “OK”.

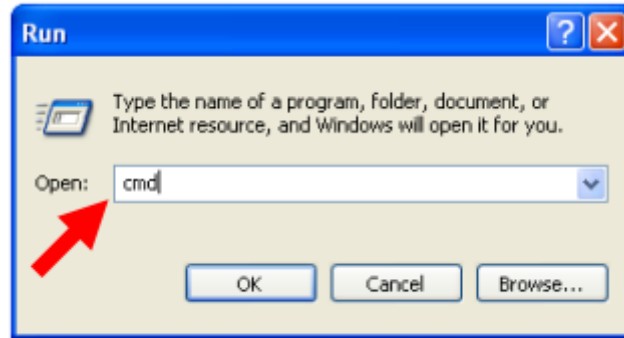

Input “ipconfig”, then press “Enter” key. Please check the IP address followed by “Default Gateway” (In this example, the gateway IP address of router is 192.168.1.1)



NOTE: If the IP address of Gateway is not displayed, or the address followed by 'IP Address' begins with "169.x.x.x", please recheck network connection between your computer and router, and / or go to the beginning of this chapter, to recheck every step of network setup procedure.

### 2.4.1 Log into Web GUI

After your computer obtained an IP address from wireless router, please start your web browser, and input the IP address of the wireless router in address bar, and the following message should be shown. Please click “admin” to login the SAPIDO GR-1142.



Enter the User name and Password in to the blank and then Click **Login**. The default values for User Name and Password are **admin** (all in lowercase letters).

# Smart Wireless Router Airplay Supported

N+ Server Router Mini – All Broadbands

**Router**

Username :

Password :

- Router
- One Button Setup
- + Parental Control
- + AirCloud Monitor
- + AirCloud Storage
- Print Server
- App
- + IP Config
- + Wireless
- + NAT
- + Firewall
- + System Management
- Log and Status
  - Network Config
  - Event Log
- helper
- Factory Default
- Logout
- Reboot

## Network Config

This page shows the current status and some basic settings of the device.

System	
Uptime	0day:0h:2m:35s
Firmware Version	Ver1.1.32
Build Time	Wed Feb 8 21:18:53 CST 2012
Wireless Configuration	
Mode	AP
Band	2.4 GHz (B+G+N)
SSID	SAPIDO_GR-1142
Channel Number	11
Encryption	Disabled
MAC Address	00:d0:41:ca:fe:b0
Associated Clients	0
LAN Configuration	
Attain IP Protocol	Fixed IP
IP Address	192.168.1.1
Subnet Mask	255.255.255.0
Default Gateway	192.168.1.1
MAC Address	00:d0:41:ca:fe:b0
WAN Configuration	
Attain IP Protocol	3.5G Disconnected
IP Address	0.0.0.0
Subnet Mask	0.0.0.0
Default Gateway	0.0.0.0
MAC Address	00:d0:41:ca:fe:b1
3.5G Configuration	
Connect Speed	Auto Switch
Signal Strength	
Network Name	
3.5G BACKUP	No

## Chapter 3 Internet Connection

This Chapter describes how to setup SAPIDO GR-1142 to the internet. The SAPIDO GR-1142 is delivered with the following factory default parameters.

*Default IP address: 192.168.1.1 (Router Mode)*

*192.168.1.254 (AP Mode)*

*192.168.1.254 (WiFi AP Mode)*

*Default IP subnet mask: 255.255.255.0*

*Web login user name: admin*

*Web login password: admin*

### 3.1 Plug and Play

The SAPIDO GR-1142 supports four types of Internet connection method: 3G modem card, wire or wireless connection via xDSL/Cable modem. Just connect the 3G modem card or Ethernet cable to SAPIDO GR-1142, the router will recognize it automatically.

#### 3.1.1 Smart Phone /iPhone Internet sharing plug and play

With SAPIDO GR-1142, you can build an instant 802.11n wireless broadband sharing environment with your iPhone, Windows Mobile or Google smart phone. During the time you can still answer calls, send SMS and charge your phone.

Step 1. Connect iPhone/Smart phone with SAPIDO GR-1142 via USB cable.



Step 2. Select “USB Tethering” as connection type.



Step 3. Click on “Done”.



Step 4. Wait few seconds for pairing. When WAN LED on, the Internet is ready to access.



**Note: 1. iPhone:**

- (1) Due to difference in 3G service bundled in various carriers, please check your 3G service supports Internet tethering.
- (2) Enable Internet Tethering on iPhone 3GS / iPhone 4, and set up the screen lock to never to prevent the sharing is interrupted unexpectedly by the iPhone screen lock feature.
2. Google Android Phone: please turn on "USB modem mode" when connecting router.
3. Window Mobile Phone: please enable "USB to PC" function.

## 3.2 Router Mode- Using as a broadband router

1. Open a Web browser, and enter <http://192.168.1.1> (Default Gateway) into the blank.

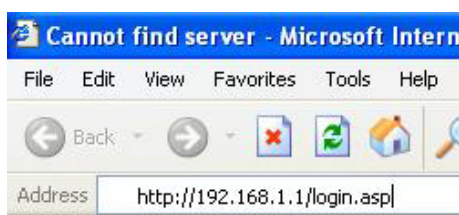

2. Enter the User name and Password into the blank and then click **Login**. The default values for User Name and Password are **admin** (all in lowercase letters).

Smart Wireless Router  
Airplay Supported

N+ Server Router Mini – All Broadbands

Router

Username : admin

Password : .....

Login

### 3.2.1 One button setup

This page is used to configure all of the server router function.

Smart Wireless Router  
Airplay Supported

SAPIDO

N+ Server Router Mini – All Broadbands GR-1142

Router

One Button Setup

This page is used to configure all of the server router function for first time.

**Time Zone Select**

Time Zone Select : (GMT+08:00)Taipei

**Change Password**

New Password: admin

**WAN Type Setup**

WAN Interface: Ethernet Port helper

WAN Access Type: Dynamic IP helper

**Wireless Setup**

SSID: SAPIDO\_GR-1142 helper

Encryption: None helper

Finish

Item	Description
Time Zone Select	Select different time zone
Change Password	Set a new password
WAN Type Setup	There are several different WAN interface , Ethernet port 、 3.5G usb dongle 、 wireless
Wireless Setup	GR-1142 support 2.4GHz band
Encryption	Input DNS information which is provided by your ISP

## 3.2.2 Parental Control

### 3.2.2.1 URL Filtering

URL Filtering is used to restrict users to access specific websites in internet

### URL Filtering

URL filter is used to deny LAN users from accessing the internet. Block those URLs which contain keywords listed below.

---

Enable URL Filtering

URL Address:

**Current Filter Table:**

URL Address	Select

Item	Description
Enable URL Filtering	Please select Enable MAC Filtering to filter MAC addresses
URL Address	Please enter the MAC address that needs to be filtered.
Apply Changes & Reset	Click on Apply Changes to save the setting data. Or you may click on Reset to clear all the input data.
Current Filter Table	It will display all ports that are filtering now.
Delete Selected & Delete All	Click <b>Delete Selected</b> will delete the selected item. Click <b>Delete All</b> will delete all items in this table.
Reset	You can click <b>Reset</b> to cancel.

Notes: This function will not be in effect when the Virtual Server is enabled. Please disable Virtual Server before activate the URL Filtering function.

### 3.2.2.2 Mac Filter Schedule

When enabled, filtering will be based on the MAC address of LAN computers. Any computer with its MAC address on this list will be blocked from accessing the Internet.

## MAC Filter Schedule

This page allows you setup the MAC address filter schedule rule. Please do not forget to configure system time and select PC MAC address before enable this feature.

Disable  
 **Enable All Mac Filter Schedule**       Enable Mac Filter Schedule

Day	Start Time	End Time
<input type="checkbox"/> Mon		
<input type="checkbox"/> Tue		
<input type="checkbox"/> Wed		
<input type="checkbox"/> Thu	00 <input type="button" value="v"/> hour 00 <input type="button" value="v"/> min	00 <input type="button" value="v"/> hour 00 <input type="button" value="v"/> min
<input type="checkbox"/> Fri		
<input type="checkbox"/> Sat		
<input type="checkbox"/> Sun		

Item	Description
<b>Enable MAC Filtering</b>	Please select Enable MAC Filtering to filter MAC addresses.
<b>MAC Address</b>	Please enter the MAC address that needs to be filtered.
<b>Comment</b>	You can add comments for this regulation.
<b>Apply Changes &amp; Reset</b>	Click on <b>Apply Changes</b> to save the setting data. Or you may click on <b>Reset</b> to clear all the input data.
<b>Current Filter Table</b>	It will display all ports that are filtering now.
<b>Delete Selected &amp; Delete All</b>	Click <b>Delete Selected</b> will delete the selected item. Click <b>Delete All</b> will delete all items in this table.
<b>Reset</b>	You can click <b>Reset</b> to cancel.

### 3.2.2.3 Schedule

Wireless available schedule

This page allows you setup the wireless schedule rule. Please do not forget to configure system time before enable this feature.

**Enable Wireless Schedule**

Enable	Day	From		To	
<input type="checkbox"/>	Sun	00 (hour)	00 (min)	00 (hour)	00 (min)
<input type="checkbox"/>	Sun	00 (hour)	00 (min)	00 (hour)	00 (min)
<input type="checkbox"/>	Sun	00 (hour)	00 (min)	00 (hour)	00 (min)
<input type="checkbox"/>	Sun	00 (hour)	00 (min)	00 (hour)	00 (min)
<input type="checkbox"/>	Sun	00 (hour)	00 (min)	00 (hour)	00 (min)
<input type="checkbox"/>	Sun	00 (hour)	00 (min)	00 (hour)	00 (min)
<input type="checkbox"/>	Sun	00 (hour)	00 (min)	00 (hour)	00 (min)
<input type="checkbox"/>	Sun	00 (hour)	00 (min)	00 (hour)	00 (min)
<input type="checkbox"/>	Sun	00 (hour)	00 (min)	00 (hour)	00 (min)
<input type="checkbox"/>	Sun	00 (hour)	00 (min)	00 (hour)	00 (min)
<input type="checkbox"/>	Sun	00 (hour)	00 (min)	00 (hour)	00 (min)

### 3.2.3 AirCloud Monitor

#### 3.2.3.1 WebCam Server1

#### 3.2.3.2 WebCam Server2

## WebCam Server 1

You can enabled or disabled WebCAM server function in this page.

**USB Port information:** No webcam plugin  
**Enable Webcam:**  Enabled  Disabled  
**Access from WAN**  Enabled  Disabled  
**Connection Port**

## WebCam Server 2

You can enabled or disabled WebCAM server function in this page.

<b>USB Port information:</b>	No webcam plugin
<b>Enable Webcam:</b>	<input checked="" type="radio"/> Enabled <input type="radio"/> Disabled
<b>Access from WAN</b>	<input checked="" type="radio"/> Enabled <input type="radio"/> Disabled
<b>Connection Port</b>	<input type="text" value="8081"/>

### 1. USB port information

Show Link webcam information

### 2. Enabling webcam

Enable or disable the webcam

### 3. Control from the WAN side

Whether to allow viewing webcam images from the WAN

### 4. Port webcam

### 5. Connection port view webcam

### 6. View live webcam video watch

### 7. Record Setup

## Webcam Advanced Configuration

Snapshot Record Settings.

<b>Save image interval:</b>	<input type="text" value="5"/> sec (default: 5)
<b>Save Location:</b>	<input checked="" type="radio"/> USB <input type="radio"/> Remote FTP
<b>Save form:</b>	<input checked="" type="radio"/> AVI <input type="radio"/> JPG
<b>Remote FTP URL ftp:</b>	<input type="text"/>
<b>Remote FTP port:</b>	<input type="text" value="21"/>
<b>Remote FTP user:</b>	<input type="text"/>
<b>Remote FTP password:</b>	<input type="text"/>
<b>Remote FTP Directory:</b>	<input type="text"/>
<b>Maximum Recording Frames:</b>	<input type="text" value="1000"/> frames (Max: 6000, Min:60)

### Recording interval

How often take an image

### Video Storage

Providing native USB storage device and a remote FTP server for storing images taken

### image format

Provide two formats AVI and JPG

### remote FTP location

If the captured image saved to a remote FTP location, be Zhen into a remote FTP location

### Remote FTP Port

FTP port used by remote

### remote FTP login account

Login account used by the remote FTP

### remote FTP Password

Login password used by the remote FTP

### folder location remote FTP Login

Login to remote FTP server can be set after the folder location used by

**maximum amount of shooting** : How many files in one folder

**Note** : a JPG file size is about 13KB, and AVI file size is about 45127KB (when maximum recording frames is 1000), file size may vary due to webcam models have different sizes

## 3.2.4 AirCloud Storage

### 3.2.4.1 FTP server

## FTP Server

You can enabled or disabled FTP server function in this page.

Enable FTP Server:  Enabled  Disabled

Enable Anonymous to Login:  Enabled  Disabled

Enable FTP Access from WAN:  Enabled  Disabled

FTP Server Port:

Idle Connection Time-Out:  Minutes(MIN: 1 default: 5)

User Name	Password	Access Right
<input type="text"/>	<input type="text"/>	<input type="checkbox"/> FTP Server
<input type="text"/>	<input type="text"/>	<input type="checkbox"/> FTP Server
<input type="text"/>	<input type="text"/>	<input type="checkbox"/> FTP Server
<input type="text"/>	<input type="text"/>	<input type="checkbox"/> FTP Server
<input type="text"/>	<input type="text"/>	<input type="checkbox"/> FTP Server
<input type="text"/>	<input type="text"/>	<input type="checkbox"/> FTP Server

Item	Description
Enable FTP Server	FTP server start or stop
Enable Anonymous to Login	Agree anonymous account login to FTP server
Enable FTP Access from WAN	Allow user access device FTP server from WAN side (internet)
FTP Server Port	Default FTP server port is 21
Idle Connection Time-Out	FTP process should have an idle timeout, which will terminate the process and close the control connection if the server is inactive (i.e., no command or data transfer in progress) for a long period of time

### 3.2.4.2 Samba management

Default is Share mode , user do not need account to access USB disk . If smaba application always need account for access USB dis , the samba security mode should be user mode ( user mode login account is “admin” , do not need password )

## Samba management

This page allows you setup the samba security and different modes.

Samba Security:  Share mode  User mode

Apply Change

### 3.2.5 WAN Interface- Ethernet Port

The WAN access type is depended on the service that you contract with the provider. The SAPIDO GR-1142 provides five selections for the WAN access type, **Static IP, DHCP Client, PPPoE, PPTP and L2TP**. Check with your ISP if you don't know the WAN type.

## WAN Interface Setup

This page is used to configure the parameters for Internet network which connects to the WAN port of your Access Point. Here you may change the access method to static IP, DHCP, PPPoE or PPTP by click the item value of WAN Access type.

WAN Interface:	Ethernet Port
WAN Access Type:	Static IP
IP Address:	Static IP
Subnet Mask:	DHCP Client
Default Gateway:	PPPoE
	PPTP
	L2TP

### 3.2.5.1 Static IP

Select **WAN** under the **IP Config** menu, and choose Ethernet Port for the WAN Interface. Its associated setting will show up.

## WAN Setup

This page is used to configure the interface for Internet network. Here you may change the interface to Ethernet port, 3.5G USB dongle or Wireless by click the item value of WAN interface.

**WAN Interface:**

**WAN Access Type:**

**IP Address:**

**Subnet Mask:**

**Default Gateway:**

**MTU Size:**  (1400-1500 bytes)

**DNS 1:**

**DNS 2:**

**DNS 3:**

**Backup select:**

Backup of connection, check connection in every  minutes.

**Service:**

**Connect Speed:**  Auto Switch  2.5G/2.75G only  3G/3.5G only

**SIM PIN:**   None

**Retype SIM PIN:**

**APN:**

**Username:**

**Password:**

**PHONE Number:**

**Clone MAC Address:**

Enable IGMP Proxy

Enable Ping Access on WAN

Enable Web Server Access on WAN

Item	Description
<b>WAN Access Type</b>	Select “Static IP”
<b>IP Address</b>	Enter the IP address which is provided by your ISP.
<b>Subnet Mask</b>	Please enter the Subnet Mask address

<b>Default Gateway</b>	Input ISP Default Gateway Address, .
<b>DNS</b>	Input DNS information which is provided by your ISP
<b>Backup select</b>	Select 3G as a back up solution or none.
<b>Clone Mac Address</b>	Some ISPs require MAC address registration. In this case, enter the MAC address registered to the provider to "Clone MAC Address"
<b>Apply Change &amp; Reset</b>	Click on <b>Apply Change</b> to save the setting date, or you may click on <b>Reset</b> to clear all the input data.

### 3.2.5.2 DHCP Client

## WAN Setup

This page is used to configure the interface for Internet network. Here you may change the interface to Ethernet port, 3.5G USB dongle or Wireless by click the item value of WAN interface.

**WAN Interface:**

**WAN Access Type:**

**Host Name:**

**MTU Size:**  (1400-1492 bytes)

**Attain DNS Automatically**  
 **Set DNS Manually**

**DNS 1:**

**DNS 2:**

**DNS 3:**

**Backup select:**

Backup of connection, check connection in every  minutes.

**Service:**

**Connect Speed:**  Auto Switch  2.5G/2.75G only  3G/3.5G only

**SIM PIN:**   None

**Retype SIM PIN:**

**APN:**

**Username:**

**Password:**

**PHONE Number:**

**Clone MAC Address:**

**Enable IGMP Proxy**  
 **Enable Ping Access on WAN**  
 **Enable Web Server Access on WAN**

Item	Description
<b>WAN Access Type</b>	Select " <b>DHCP Client</b> "
<b>Host Name</b>	You can keep the default as the host name, or input a specific name if required by your ISP.
<b>DNS</b>	Select <b>Attain DNS Automatically</b> . Or select <b>Set DNS Manually</b> , if you want to specify the DNS, and enter the DNS provided by your ISP in DNS 1 2 3.
<b>Backup select</b>	Select 3G as a back up solution or none.
<b>Clone Mac Address</b>	Some ISPs require MAC address registration. In this case, enter the MAC address registered to the provider to "Clone MAC Address"
<b>Apply Change &amp; Reset</b>	Click on <b>Apply Change</b> to save the setting date, or you may click on <b>Reset</b> to clear all the input data.

### 3.2.5.3 PPPoE

## WAN Setup

This page is used to configure the interface for Internet network. Here you may change the interface to Ethernet port, 3.5G USB dongle or Wireless by click the item value of WAN interface.

---

**WAN Interface:**

**WAN Access Type:**

**User Name:**

**Password:**

**Service Name:**

**Connection Type:**

**Idle Time:**  (1-1000 minutes)

**MTU Size:**  (1360-1492 bytes)

**Attain DNS Automatically**  
 **Set DNS Manually**

**DNS 1:**

**DNS 2:**

**DNS 3:**

**Backup select:** 3.5G Backup ▾  
 Backup of connection, check connection in every 3 minutes.

**Service:** UMTS/HSPA/HSDPA/HSUPA ▾

**Connect Speed:**  Auto Switch  2.5G/2.75G only  3G/3.5G only

**SIM PIN:**    None

**Retype SIM PIN:**  

**APN:** internet

**Username:**  

**Password:**  

**PHONE Number:** \*99#

**Clone MAC Address:** 000000000000

Enable IGMP Proxy  
 Enable Ping Access on WAN  
 Enable Web Server Access on WAN

Apply Change Reset

Item	Description
<b>WAN Access Type</b>	Select " <b>PPPoE</b> "
<b>User Name</b>	Input your user name provided by your ISP. If you don't know, please check with your ISP.
<b>Password</b>	Input the password provided by your ISP.
<b>Service Name</b>	Input the service name provided by your ISP.
<b>Connection Type</b>	Three types for select: <b>Continues</b> , <b>Connect on Demand</b> , and <b>Manual</b> .
<b>DNS</b>	Select <b>Attain DNS Automatically</b> . Or select <b>Set DNS Manually</b> , if you want to specify the DNS, and enter the DNS provided by your ISP in DNS 1 2 3.
<b>Backup select</b>	Select 3G as a back up solution or none.
<b>Clone Mac Address</b>	Some ISPs require MAC address registration. In this case, enter the MAC address registered to the provider to "Clone MAC Address"
<b>Apply Change &amp; Reset</b>	Click on <b>Apply Change</b> to save the setting date, or you may click on <b>Reset</b> to clear all the input data.

### 3.2.5.4 PPTP

## WAN Setup

This page is used to configure the interface for Internet network. Here you may change the interface to Ethernet port, 3.5G USB dongle or Wireless by click the item value of WAN interface.

**WAN Interface:**

**WAN Access Type:**

**Address Mode:**  Dynamic  Static

**Server IP Address:**

**User Name:**

**Password:**

**MTU Size:**  (1400-1460 bytes)

Enable MPPE Encryption  
 Enable MPPC Compression  
 Attain DNS Automatically  
 Set DNS Manually

**DNS 1:**   
**DNS 2:**   
**DNS 3:**

**Backup select:**

Backup of connection, check connection in every  minutes.

**Service:**

**Connect Speed:**  Auto Switch  2.5G/2.75G only  3G/3.5G only

**SIM PIN:**   None

**Retype SIM PIN:**

**APN:**

**Username:**

**Password:**

**PHONE Number:**

**Clone MAC Address:**

Enable IGMP Proxy  
 Enable Ping Access on WAN  
 Enable Web Server Access on WAN

Item	Description
WAN Access Type	Select "PPTP"
Server IP Address	Input your server IP address provided by your ISP. If you don't know, please check with your ISP.

<b>User Name</b>	Input PPTP account provided by your ISP.
<b>Password</b>	Input the password provided by your ISP.
<b>DNS</b>	Select <b>Attain DNS Automatically</b> . Or select <b>Set DNS Manually</b> , if you want to specify the DNS, and enter the DNS provided by your ISP in DNS 1 2 3.
<b>Backup select</b>	Select 3G as a back up solution or none.
<b>Clone Mac Address</b>	Some ISPs require MAC address registration. In this case, enter the MAC address registered to the provider to "Clone MAC Address"
<b>Apply Change &amp; Reset</b>	Click on <b>Apply Change</b> to save the setting date, or you may click on <b>Reset</b> to clear all the input data.

### 3.2.5.5 L2TP

#### WAN Setup

This page is used to configure the interface for Internet network. Here you may change the interface to Ethernet port, 3.5G USB dongle or Wireless by click the item value of WAN interface.

**WAN Interface:**

**WAN Access Type:**

**Address Mode:**  Dynamic  Static

**Server IP Address/Host Name:**

**User Name:**

**Password:**

**MTU Size:**  (1400-1460 bytes)

**Attain DNS Automatically**  
 **Set DNS Manually**

**DNS 1:**   
**DNS 2:**   
**DNS 3:**

**Backup select:**

Backup of connection, check connection in every  minutes.

**Service:**

**Connect Speed:**  Auto Switch  2.5G/2.75G only  3G/3.5G only

**SIM PIN:**   None

**Retype SIM PIN:**

**APN:**

**Username:**

**Password:**

**PHONE Number:**

**Clone MAC Address:**

**Enable IGMP Proxy**  
 **Enable Ping Access on WAN**  
 **Enable Web Server Access on WAN**

Item	Description
<b>WAN Access Type</b>	Select " <b>PPTP</b> "
<b>Server IP Address / Host Name</b>	Input your server IP address or Host Name provided by your ISP. If you don't know, please check with your ISP.
<b>User Name</b>	Input PPTP account provided by your ISP.
<b>Password</b>	Input the password provided by your ISP.
<b>DNS</b>	Select <b>Attain DNS Automatically</b> . Or select <b>Set DNS Manually</b> , if you want to specify the DNS, and enter the DNS provided by your ISP in DNS 1 2 3.
<b>Backup select</b>	Select 3G as a back up solution or none.
<b>Clone Mac Address</b>	Some ISPs require MAC address registration. In this case, enter the MAC address registered to the provider to "Clone MAC Address"
<b>Apply Change &amp; Reset</b>	Click on <b>Apply Change</b> to save the setting date, or you may click on <b>Reset</b> to clear all the input data.

### 3.2.5.6 Advance function

Item	Description
<b>MTU</b>	Maximum Transmission Unit. Usually provide by computer operation systems (OS). Advanced users can set it manually.
<b>Request MPPE Encryption</b>	Microsoft Point-to-Point Encryption (MPPE) provides data security for the PPTP connection that is between the VPN client and VPN server.
<b>Enable IGMP Proxy</b>	<b>Enable IGMP Proxy</b> to provide the service for IP hosts and adjacent multicast routers to establish multicast group memberships.
<b>Enable Ping Access on WAN</b>	<b>Enable Ping Access on WAN</b> will make WAN IP address response to any ping request from Internet users. However, it is also a comma way for hacker to ping public WAN IP address, to see is there any WAN IP address available.
<b>Enable Web Server Access on WAN</b>	This option is to enable <b>Web Server Access</b> function on WAN.

### 3.2.6 WAN Interface- 3G USB dongle

Select **WAN** under the **IP Config** menu, and choose 3G usb dongle for the WAN Interface. Its associated setting will show as below.

## WAN Setup

This page is used to configure the interface for Internet network. Here you may change the interface to Ethernet port, 3.5G USB dongle or Wireless by click the item value of WAN interface.

**WAN Interface:**

**Service:**

**Connect Speed:**  Auto Switch  2.5G/2.75G only  3G/3.5G only

**SIM PIN:**   None

**Retype SIM PIN:**

**APN:**

**Username:**

**Password:**

**PHONE Number:**

Attain DNS Automatically  
 Set DNS Manually

**DNS 1:**   
**DNS 2:**   
**DNS 3:**

**Clone MAC Address:**

Always  
 Dial on demand

**Idle**  (0-60 Minutes, if input 0 or no input, it will set to Always mode)

Manual

Enable IGMP Proxy  
 Enable Ping Access on WAN  
 Enable Web Server Access on WAN

Item	Description
<b>APN (Access Point Name)</b>	Enter the access point name. If you do not know the setting information for APN, check with your 3G service provider.
<b>User Name</b>	Enter the User Name supplied by the provider.
<b>Password</b>	Enter the password supplied by the provider.
<b>Phone Number</b>	Enter the subscribing access point's phone number.
<b>DNS</b>	Select <b>Attain DNS Automatically</b> . Or select <b>Set DNS Manually</b> , if you want to specify the DNS, and enter the DNS provided by your ISP in DNS 1 2 3.
<b>Clone Mac Address</b>	Some ISPs require MAC address registration. In this case, enter the MAC address registered to the provider to "Clone MAC Address"
<b>Always / Dial on demand</b>	If your 3G USB adapter is a pay-as-you-go plan base, select "Dial on demand" and disconnect the connection when you don't use the

	internet.
<b>Enable IGMP Proxy</b>	<b>Enable IGMP Proxy</b> to provide the service for IP hosts and adjacent multicast routers to establish multicast group memberships.
<b>Enable Ping Access on WAN</b>	<b>Enable Ping Access on WAN</b> will make WAN IP address response to any ping request from Internet users. However, it is also a comma way for hacker to ping public WAN IP address, to see is there any WAN IP address available.
<b>Enable Web Server Access on WAN</b>	This option is to enable <b>Web Server Access</b> function on WAN.
<b>Apply Change</b>	Click " <b>Finish</b> " to complete the setting

Rebooting this product is started. Please wait for a while.

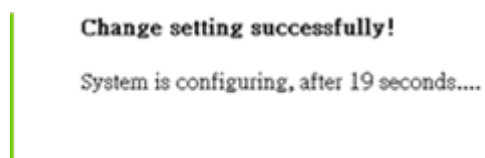

### 3.2.7 WAN Interface- Wireless

Select WAN under the IP Config menu, and choose wireless for the WAN Interface. Its associated setting will show as below.

## WAN Setup

This page is used to configure the interface for Internet network. Here you may change the interface to Ethernet port, 3.5G USB dongle or Wireless by click the item value of WAN interface.

WAN Interface:

SSID	BSSID	Channel	Type	Encrypt	Signal	Select
3+4G_GR	00:1f1fd5:a9:78	3 (B+G+N)	AP	no	64	<input type="radio"/>
GR-1733	80:1f02:13:d8:14	3 (B+G+N)	AP	no	28	<input type="radio"/>

Encryption:

WAN Access Type:

Host Name:

MTU Size:  (1400-1492 bytes)

Attain DNS Automatically  
 Set DNS Manually

DNS 1:

DNS 2:

DNS 3:

Clone MAC Address:

Enable IGMP Proxy  
 Enable Ping Access on WAN  
 Enable Web Server Access on WAN

Item	Description
Refresh	You can see a list of available Wireless networks. Select the preferred one.
Encryption type	Select the Encryption type form the drop-down list.
WAN Access Type	Select Static IP, DHCP, PPPoE, PPTP or L2TP.
DNS	Select <b>Attain DNS Automatically</b> . Or select <b>Set DNS Manually</b> , if you want to specify the DNS, and enter the DNS provided by your ISP in DNS 1 2 3.
Clone Mac Address	Some ISPs require MAC address registration. In this case, enter the MAC address registered to the provider to "Clone MAC Address"
Apply Change & Reset	Click on <b>Apply Change</b> to save the setting date, or you may click on <b>Reset</b> to clear all the input data.

### 3.3 AP Mode-Using as a Access Point

Make sure to shift the mode into AP Mode.

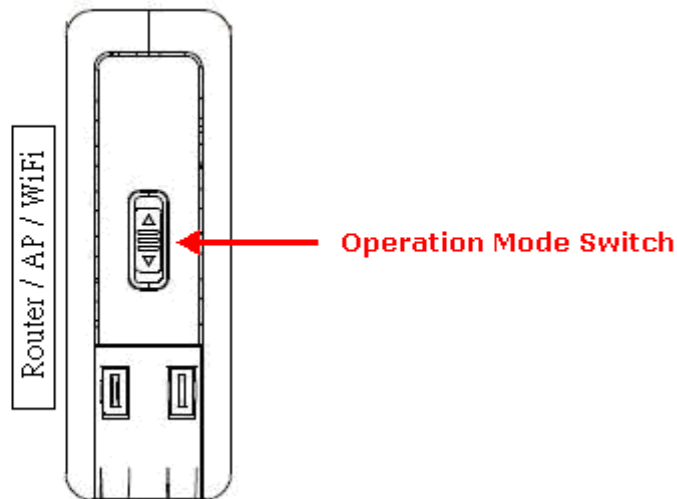

When this product is used as an access point, the IP address has to be changed. The default IP under AP mode is 192.168.1.254.

1. Open a Web browser, and enter <http://192.168.1.254> (Default Gateway) into the blank.

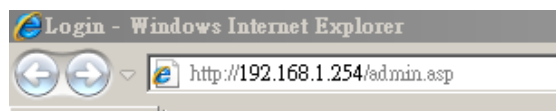

2. Enter the User name and Password in to the blank and then Click **Login**. The default values for User Name and Password are **admin** (all in lowercase letters).



Select **LAN** under the **IP Config** menu

## LAN Interface Setup

This page is used to configure the parameters for local area network which connects to the LAN port of your Access Point. Here you may change the setting for IP address, subnet mask, DHCP, etc..

IP Address:	<input type="text" value="192.168.1.254"/>
Subnet Mask:	<input type="text" value="255.255.255.0"/>
Default Gateway:	<input type="text" value="0.0.0.0"/>
DHCP:	<input type="text" value="Server"/> <input type="button" value="v"/>
DHCP Client Range:	<input type="text" value="192.168.1.100"/> - <input type="text" value="192.168.1.200"/> <input type="button" value="Show Client"/>
DHCP Lease Time:	<input type="text" value="480"/> (1 ~ 10080 minutes)
Static DHCP:	<input type="button" value="Set Static DHCP"/>
Device Name:	<input type="text" value="SAPIDO_GR-1142"/>
802.1d Spanning Tree:	<input type="text" value="Disabled"/> <input type="button" value="v"/>
Clone MAC Address:	<input type="text" value="000000000000"/>

Item	Description
<b>Device Name</b>	Input a name for this router.
<b>IP Address</b>	The default IP address is 192.168.1.254
<b>Subnet Mask</b>	Enter the Subnet Mask address
<b>Default Gateway</b>	Enter the Default Gateway address for LAN interfaces
<b>DHCP</b>	Select DHCP type: <b>Client</b> , <b>Disable</b> , or <b>Server</b> under different environment.
<b>DHCP Client Range</b>	When enable DHCP server, you can fill in the start and end IP address; client will be assigned an IP address from the range.
<b>802.1d Spanning Tree</b>	Disable or Enable the 802.1d Spanning Tree Protocol (STP)
<b>Clone Mac Address</b>	Some ISPs require MAC address registration. In this case, enter the MAC address registered to the provider to "Clone MAC Address"
<b>Apply Change &amp; Reset</b>	Click on <b>Apply Change</b> to save the setting date, or you may click on <b>Reset</b> to clear all the input data.

### 3.4 WiFi AP Mode- Using as a Network Converter

Make sure to shift the mode into WiFi AP Mode.

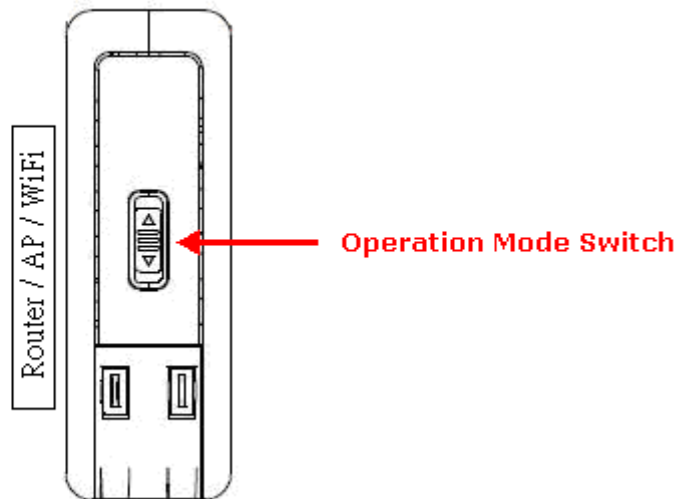

The default gateway is <http://192.168.1.254> and for User Name and Password are **admin** (all in lowercase letters). Click **Login** to enter.

A screenshot of the router's web interface. At the top, an orange banner reads "Smart Wireless Router Airplay Supported" and "N+ Server Router Mini - All Broadbands". Below this is a "WiFi AP" section with a "Username" field containing "admin" and a "Password" field with six dots. A "Login" button is positioned below the password field.

## LAN Interface Setup

This page is used to configure the parameters for local area network which connects to the LAN port of your Access Point. Here you may change the setting for IP address, subnet mask, DHCP, etc..

IP Address:	<input type="text" value="192.168.1.254"/>
Subnet Mask:	<input type="text" value="255.255.255.0"/>
Default Gateway:	<input type="text" value="0.0.0.0"/>
DHCP:	<input type="text" value="Server"/> <input type="button" value="v"/>
DHCP Client Range:	<input type="text" value="192.168.1.100"/> - <input type="text" value="192.168.1.200"/> <input type="button" value="Show Client"/>
DHCP Lease Time:	<input type="text" value="480"/> (1 ~ 10080 minutes)
Static DHCP:	<input type="button" value="Set Static DHCP"/>
Device Name:	<input type="text" value="SAPIDO_GR-1142"/>
802.1d Spanning Tree:	<input type="text" value="Disabled"/> <input type="button" value="v"/>
Clone MAC Address:	<input type="text" value="000000000000"/>

Item	Description
Device Name	Input a name for this router.
IP Address	The default IP address is 192.168.1.254
Subnet Mask	Enter the Subnet Mask address
Default Gateway	Enter the Default Gateway address for LAN interfaces
DHCP	Select DHCP type: <b>Client</b> , <b>Disable</b> , or <b>Server</b> under different environment.
DHCP Client Range	When enable DHCP server, you can fill in the start and end IP address; client will be assigned an IP address from the range.
802.1d Spanning Tree	Disable or Enable the 802.1d Spanning Tree Protocol (STP)
Clone Mac Address	Some ISPs require MAC address registration. In this case, enter the MAC address registered to the provider to "Clone MAC Address"
Apply Change & Reset	Click on <b>Apply Change</b> to save the setting date, or you may click on <b>Reset</b> to clear all the input data.

## Chapter 4 Wireless Setup

### 4.1 Wireless Setup

There are two ways to setup wireless LAN with SAPIDO GR-1142. You can use either way to setup Wireless LAN.

#### 4.1.1 Setup Wireless LAN by WPS button

You can setup wireless LAN easily by using the WPS button if both WLAN router and the WLAN adapter (client) are WPS supported. Before starting the setup, please check the things below:

λ Get ready for Internet connection with SAPIDO GR-1142

λ The WLAN adapter is finished installation and plug in your computer/ laptop.

There are two ways to setup a wireless LAN between SAPIDO GR-1142 and your wireless adapter:

1. Setup with WPS button, if your wireless adapter has a physical WPS button.
  - (1) Press the WPS button (A) from SAPIDO GR-1142 and wait for Wireless/WPS LED light (B) changed into orange.
  - (2) Press the WPS button (C) from the adapter until the setup window shows up.

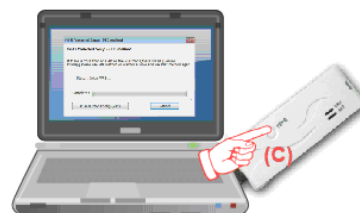
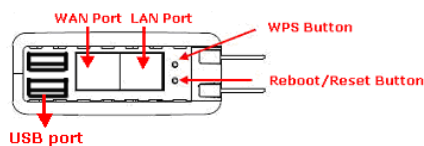

- (3) Open a web browser to check the internet connection.

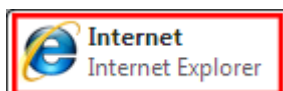

- (4) Setup without WPS button if your wireless adapter has only a virtual WPS function.  
(5) Open the wireless adapter utility.



- (6) Press the WPS button (A) on the SAPIDO GR-1142 and wait for the Wireless/WPS LED light (B) to change to orange.

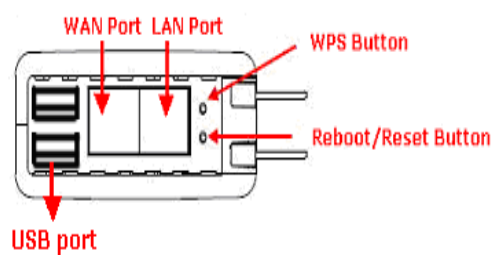

- (7) Back to the WLAN adapter utility and click the "PBC" (C) button.



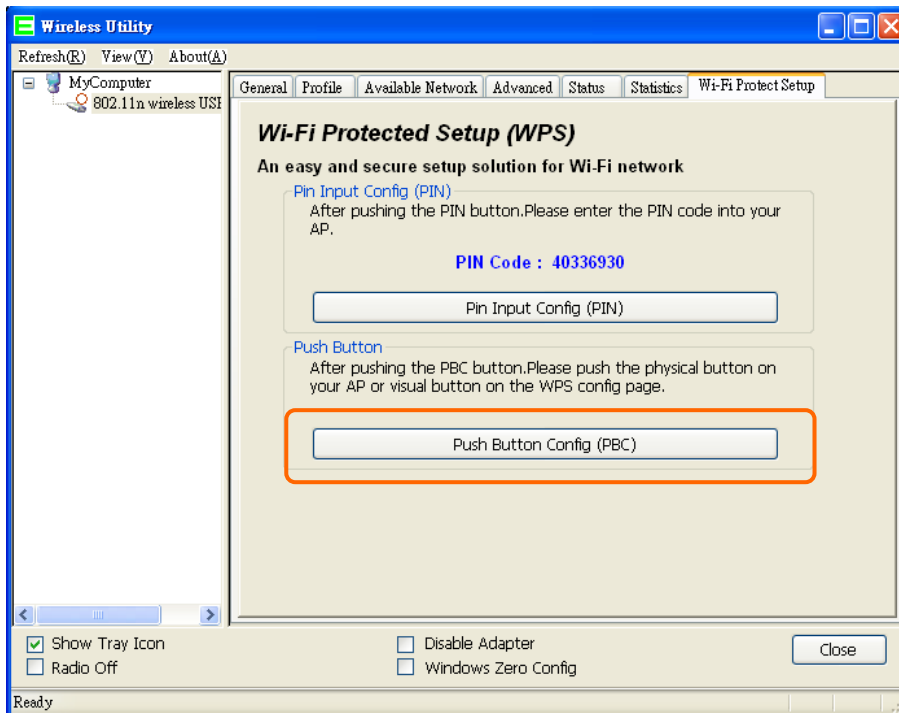

The utility will start searching the destination connection.

(8) Confirm the information form the Utility

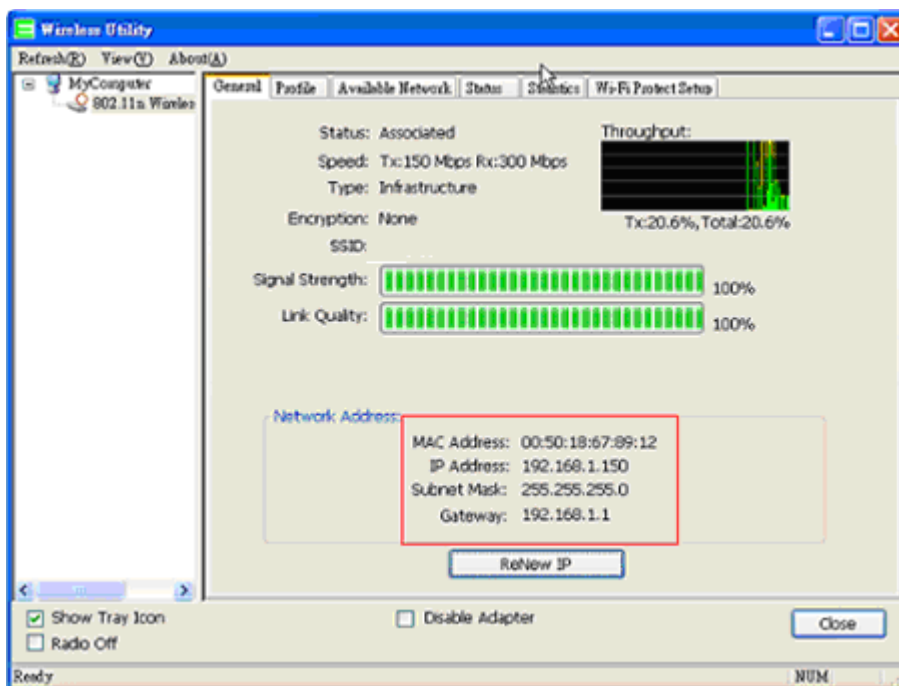

(9) After completes the WPS setup. Please confirm that it can be connected to the Internet.

Note: The setup image might be some differences when using other branded Adapter.

## 4.1.2 Wireless Basic Setup from Web GUI

The Wireless Basic Settings include Band, Mode, SSID, Channel Number and other wireless settings.

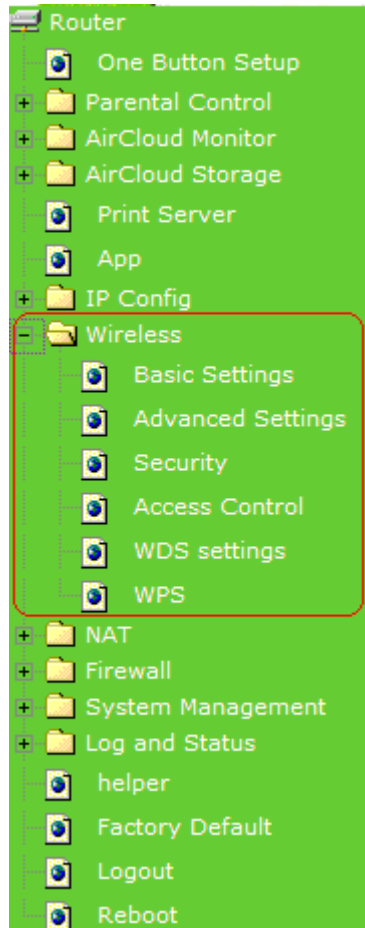

## Wireless Basic Settings

This page is used to configure the parameters for wireless LAN clients which may connect to your Access Point. Here you may change wireless encryption settings as well as wireless network parameters.

Disable Wireless LAN Interface

Band:

Mode:

Network Type:

SSID:

Channel Width:  ( 40MHz provides the fastest data transmission rate, however, if the wireless signal is unstable, such as in Hong Kong, please select the setting to auto. )

Control Sideband:

Channel Number:

Broadcast SSID:

WMM:

Data Rate:

Associated Clients:

Enable Mac Clone (Single Ethernet Client)

Enable Universal Repeater Mode (Acting as AP and client simultaneously)

SSID of Extended Interface:

Item	Description
<b>Disable Wireless LAN Interface</b>	Turn off the wireless service.
<b>Band</b>	Select the frequency. It has 6 options: 2.4 GHz (B/G/N/B+G/G+N/B+G+N).
<b>Mode</b>	Select the mode. It has 3 modes to select: (AP, Client, WDS, AP+WDS). Multiple AP: Please check Section 4.1.2.1. * In Wi-Fi AP mode only support Client mode.
<b>SSID</b>	Service Set identifier, users can define to any or keep as default.
<b>Channel Width</b>	Please select the channel width, it has 2 options: 20MHZ, and 40MHZ.
<b>Control Sideband</b>	Enable this function will control your router use lower or upper channel.
<b>Channel Number</b>	Please select the channel; it has Auto, 1, 2~11 or 13 options.
<b>Broadband SSID</b>	User may choose to enable <b>Broadcast SSID</b> or not.

<b>Data Rate</b>	Please select the data transmission rate.
<b>Associate Clients</b>	Check the AP connectors and the Wireless connecting status.
<b>Enable MAC Clone (Single Ethernet Client)</b>	Clone the MAC address for ISP to identify.
<b>Enable Universal Repeater Mode (Acting as AP and Client simultaneously)</b>	Allow to equip with the wireless way conjunction upper level, provide the bottom layer user link in wireless and wired way in the meantime.  (The IP that bottom layer obtains is from upper level.) Please also check Section 4.1.2.2
<b>SSID of Extended Interface</b>	While linking the upper level device in wireless way, you can set SSID to give the bottom layer user search.
<b>Apply Change &amp; Reset</b>	Click on <b>Apply Change</b> to save the setting date, or you may click on <b>Reset</b> to clear all the input data.

\* Under WiFi AP Mode, there are 2 options of Network type: Infrastructure or Ad hoc. Select Infrastructure if connecting to a wireless router or access point. Select Ad hoc if connecting directly to another wireless adapter.

#### 4.1.2.1 Multiple APs

The SAPIDO GR-1142 can register up to 4 SSIDs (wireless LAN group). It can be used as if there are multiple wireless LAN access points with one product. Each SSID could be set with different data rate, WMM and access type.

### Multiple APs

This page shows and updates the wireless setting for multiple APs.

No.	Enable	Band	SSID	Data Rate	Broadcast SSID	WMM	Access	Active Client List
AP1	<input checked="" type="checkbox"/>	2.4 GHz (B+G+N) ▾	Multiple_AP1	Auto ▾	Enabled ▾	Enabled ▾	LAN+WAN ▾	Show
AP2	<input checked="" type="checkbox"/>	2.4 GHz (B+G+N) ▾	Multiple_AP2	Auto ▾	Enabled ▾	Enabled ▾	LAN+WAN ▾	Show
AP3	<input checked="" type="checkbox"/>	2.4 GHz (B+G+N) ▾	Multiple_AP3	Auto ▾	Enabled ▾	Enabled ▾	LAN+WAN ▾	Show
AP4	<input checked="" type="checkbox"/>	2.4 GHz (B+G+N) ▾	Multiple_AP4	Auto ▾	Enabled ▾	Enabled ▾	LAN+WAN ▾	Show

Item	Description
<b>Enable</b>	Enable or disable the service.
<b>Band</b>	Select the frequency.
<b>SSID</b>	Enter the SSID
<b>Data Rate</b>	Select the data transmission rate.
<b>Access</b>	Enable this function can let clients use two access types: a. LAN+WAN: the client can access to the Internet and access in the

	router's GUI. b. WAN: the client can only access to the Internet.
<b>Active Client List</b>	Display the properties of the client which is connecting successfully.
<b>Apply Change &amp; Reset</b>	Click on <b>Apply Change</b> to save the setting date, or you may click on <b>Reset</b> to clear all the input data.

#### 4.1.2.2 Enable Universal Repeater Mode

The router can act as Station and AP at the same time. It can use Station function to connect to a Root AP and use AP function to service all wireless stations within its coverage.



Example: When users enable the Universal Repeater to connect to the upper level device, please fill in the upper level devices channel and SSID. Click on Apply Changes to save the settings.

(Please disable the DHCP service first)

## Wireless Basic Settings

This page is used to configure the parameters for wireless LAN clients which may connect to your Access Point. Here you may change wireless encryption settings as well as wireless network parameters.

---

Disable Wireless LAN Interface

Band:

Mode:

Network Type:

SSID:

Channel Width:  ( 40MHz provides the fastest data transmission rate, however, if the wireless signal is unstable, such as in Hong Kong, please select the setting to auto. )

Control Sideband:

Channel Number:

Broadcast SSID:

WMM:

Data Rate:

Associated Clients:

Enable Mac Clone (Single Ethernet Client)

Enable Universal Repeater Mode (Acting as AP and client simultaneously)

SSID of Extended Interface:

Users can use the Network Configuration page to check the information about “Wireless Repeater Interface Configuration”.

### 4.2 Wireless Security Setup

## Network Config

This page shows the current status and some basic settings of the device.

System	
Uptime	0day:2h:41m:2s
Firmware Version	Ver1.1.32
Build Time	Wed Feb 8 21:18:53 CST 2012
Wireless Configuration	
Mode	AP
Band	2.4 GHz (B+G+N)
SSID	SAPIDO_GR-1142
Channel Number	11
Encryption	Disabled
MAC Address	00:d0:41:ca:fe:b0
Associated Clients	0
WirelessRepeater Interface Configuration	
Mode	Infrastructure Client
ESSID	ESSID_SAPIDO_GR-1142
Encryption	Disabled
MAC Address	00:00:00:00:00:00
State	Scanning
LAN Configuration	
Attain IP Protocol	Fixed IP
IP Address	192.168.1.1
Subnet Mask	255.255.255.0
Default Gateway	192.168.1.1
MAC Address	00:d0:41:ca:fe:b0

Here users define the security type and level of the wireless network. Selecting different methods provides different levels of security. **Please note that using any encryption may cause a significant degradation of data throughput on the wireless link.** There are five Encryption types supported: "None", "WEP", "WPA (TKIP)", "WPA2(AES)", and "WPA2 Mixed". Enabling WEP can protect your data from eavesdroppers. If you do not need this feature, select "None" to skip the following setting.

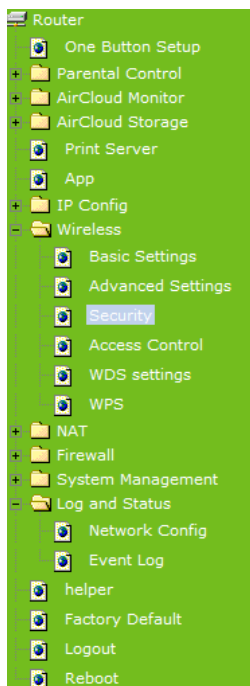

## Wireless Security Setup

This page allows you setup the wireless security. Turn on WEP or WPA by using Encryption Keys could prevent any unauthorized access to your wireless network.

Select SSID:

Encryption:    
 802.1x Authentication:

### 1. Encryption- WEP Key

(1) Set WEP Key: This section provides 64bit and 128bit WEP encryptions and two different shared key formats (ASCII and Hex) for wireless network.

## Wireless Security Setup

This page allows you setup the wireless security. Turn on WEP or WPA by using Encryption Keys could prevent any unauthorized access to your wireless network.

Select SSID:

Encryption:    
 802.1x Authentication:    
 Authentication:  Open System  Shared Key  Auto   
 Key Length:    
 Key Format:    
 Encryption Key:

### (2) 802.1x Authentication

It is a safety system by using authentication to protect your wireless network.

### 2. Encryption- WPA (WPA, WPA2, and WPA2 Mixed), WPA Authentication Mode

(1) Enterprise (RADIUS): Please fill in the RADIUS server Port, IP Address, and

Password

## Wireless Security Setup

This page allows you setup the wireless security. Turn on WEP or WPA by using Encryption Keys could prevent any unauthorized access to your wireless network.

---

Select SSID:	<input type="text" value="Root AP - SAPIDO_GR-1142"/>	<input type="button" value="Apply Change"/>	<input type="button" value="Reset"/>
--------------	---	---	--------------------------------------

---

Encryption:	<input type="text" value="WPA"/>
Authentication Mode:	<input checked="" type="radio"/> Enterprise (RADIUS) <input type="radio"/> Personal (Pre-Shared Key)
WPA Cipher Suite:	<input type="checkbox"/> TKIP <input type="checkbox"/> AES
RADIUS Server IP Address:	<input type="text"/>
RADIUS Server Port:	<input type="text" value="1812"/>
RADIUS Server Password:	<input type="text"/>

- (2) Personal (Pre-Shared Key): Pre-Shared Key type is ASCII Code; the length is between 8 to 63 characters. If the key type is Hex, the key length is 64 characters.

---

## Wireless Security Setup

This page allows you setup the wireless security. Turn on WEP or WPA by using Encryption Keys could prevent any unauthorized access to your wireless network.

---

Select SSID:	<input type="text" value="Root AP - SAPIDO_GR-1142"/>	<input type="button" value="Apply Change"/>	<input type="button" value="Reset"/>
--------------	---	---	--------------------------------------

---

Encryption:	<input type="text" value="WPA"/>
Authentication Mode:	<input type="radio"/> Enterprise (RADIUS) <input checked="" type="radio"/> Personal (Pre-Shared Key)
WPA Cipher Suite:	<input type="checkbox"/> TKIP <input type="checkbox"/> AES
Pre-Shared Key Format:	<input type="text" value="Passphrase"/>
Pre-Shared Key:	<input type="text"/>

- (3) Apply Change & Reset: Click on 'Apply Changes' to save setting data. Or click 'Reset' to reset all the input data.

### 4.3 Wireless Access Control

Access Control allows user to block or allow wireless clients to access this router. Users can select the access control mode, then add a new MAC address with a simple comment and

click on “Apply Change” to save the new addition. To delete a MAC address, select its corresponding checkbox under the Select column and click on “Delete Selected” button.

**Wireless Access Control**

If you choose 'Allowed Listed', only those clients whose wireless MAC addresses are in the access control list will be able to connect to your Access Point. When 'Deny Listed' is selected, these wireless clients on the list will not be able to connect the Access Point.

Wireless Access Control Mode:

MAC Address:  Comment:

Current Access Control List:

MAC Address	Comment	Select
-------------	---------	--------

Take the wireless card as the example.

(1) Please select Deny Listed in Wireless Access Control Mode first, and then fill in the MAC address what you plan to block in the MAC Address field. Click Apply Changes to save the setting.

**Wireless Access Control**

If you choose 'Allowed Listed', only those clients whose wireless MAC addresses are in the access control list will be able to connect to your Access Point. When 'Deny Listed' is selected, these wireless clients on the list will not be able to connect the Access Point.

Wireless Access Control Mode:

MAC Address:  Comment:

Current Access Control List:

MAC Address	Comment	Select
0018F8638A54		<input type="checkbox"/>

(2) The MAC address what you set will be displayed on the Current Access Control List.

### Wireless Access Control

If you choose 'Allowed Listed', only those clients whose wireless MAC addresses are in the access control list will be able to connect to your Access Point. When 'Deny Listed' is selected, these wireless clients on the list will not be able to connect the Access Point.

Wireless Access Control Mode:

MAC Address:  Comment:

Current Access Control List:

MAC Address	Comment	Select
00:18:f8:63:8a:54		<input type="checkbox"/>

(3) The wireless client will be denied by the wireless router.

## Chapter 5 Router Mode Security Setup

This section contains configurations for the SAPIDO GR-1142's advanced functions such as: virtual server, DMZ, and Firewall to provide your network under a security environment.

### 5.1 NAT

#### 5.1.1 Virtual Server

The Virtual Server feature allows users to create Virtual Servers by re-directing a particular range of service port numbers (from the WAN port) to a particular LAN IP address.

#### Port Forwarding

Entries in this table allow you to automatically redirect common network services to a specific machine behind the NAT firewall. These settings are only necessary if you wish to host some sort of server like a web server or mail server on the private local network behind your Gateway's NAT firewall.

**Enable Port Forwarding**

Address:  Protocol: **Both** Public Port Range:  -   
Comment:

Current Port Forwarding Table:

Local IP Address	Protocol	Port Range	Comment	Select
------------------	----------	------------	---------	--------

Item	Description
<b>Enable Port Forwarding</b>	Select to enable Port Forwarding service or not.
<b>Address</b>	Specify the IP address which receives the incoming packets.
<b>Protocol</b>	Select the protocol type.
<b>Public Port Range</b>	Enter the port number, for example 80-80.
<b>Private Port Range</b>	Enter the port number, for example 20-22.
<b>Comment</b>	Add comments for this port forwarding rule.
<b>Add</b>	Click on <b>Add</b> to enable the settings.
<b>Current Port Forwarding Table</b>	It will display all port forwarding regulation you made.
<b>Delete Selected &amp; Delete All</b>	Click <b>Delete Selected</b> will delete the selected item. Click <b>Delete All</b> will delete all items in this table.
<b>Reset</b>	Click <b>Reset</b> to cancel.

Please find the following figure to know that what the virtual server is. The web server is located on 192.168.1.100, forwarding port is 80, and type is TCP+UDP.

Configuration:

**Configuration:**

**Private IP: 192.168.1.100**

**Port: 80-80**

**Type: TCP +UDP**

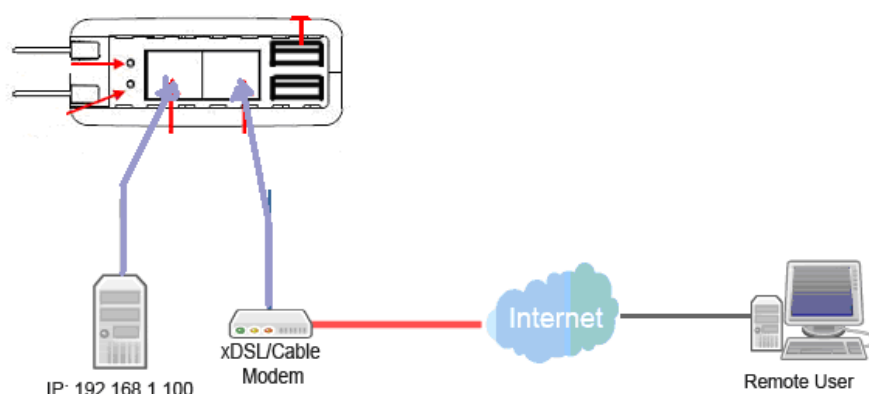

### 5.1.2 Virtual DMZ

The DMZ feature allows one local user to be exposed to the Internet for special-purpose applications like Internet gaming or videoconferencing. When enabled, this feature opens all ports to a single station and hence renders that system exposed to intrusion from outside. The port forwarding feature is more secure because it only opens the ports required by that application.

### Virtual DMZ

A Demilitarized Zone is used to provide Internet services without sacrificing unauthorized access to its local private network. Typically, the DMZ host contains devices accessible to Internet traffic, such as Web (HTTP) servers, FTP servers, SMTP (e-mail) servers and DNS servers.

Enable DMZ

DMZ Host IP Address:

Item	Description
Enable DMZ	It will enable the DMZ service if you select it.

<b>DMZ Host IP Address</b>	Please enter the specific IP address for DMZ host.
<b>Apply Changes &amp; Reset</b>	Click on <b>Apply Changes</b> to save the setting data. Or you may click on <b>Reset</b> to clear all the input data.

## 5.2 Firewall

### 5.2.1 QoS

The QoS can let you classify Internet application traffic by source/destination IP address and port number. To assign priority for each type of application and reserve bandwidth can let you have a better experience in using critical real time services like Internet phone, video

#### QoS

Entries in this table improve your online gaming experience by ensuring that your game traffic is prioritized over other network traffic, such as FTP or Web.

**Enable QoS**  
 **Automatic Uplink Speed**  
**Manual Uplink Speed (Kbps):**

**Automatic Downlink Speed**  
**Manual Downlink Speed (Kbps):**

**QoS Rule Advanced Settings:**

**Address Type:**       IP     MAC

**Local IP Address:**       -

**MAC Address:**     

**Mode:**     

**Uplink Bandwidth (Kbps):**     

**Downlink Bandwidth (Kbps):**     

**Comment:**     

Current QoS Rules Table:

Local IP Address	MAC Address	Mode	Uplink Bandwidth (Kbps)	Downlink Bandwidth (Kbps)	Comment	Select

conference ...etc.

Item	Description
<b>Enable QoS</b>	Check "Enable QoS" to enable QoS function for the WAN port. You also can uncheck "Enable QoS" to disable QoS function for the WAN port.
<b>Automatic uplink speed / Manual Uplink Speed</b>	Set the uplink speed by manual to assign the download or upload bandwidth by the unit of Kbps or check the Automatic uplink speed.
<b>Automatic downlink speed / Manual Downlink Speed</b>	Set the downlink speed by manual to assign the download or upload bandwidth by the unit of Kbps or check the Automatic downlink speed.

QoS Rule Advance Setting:	
<b>Address Type</b>	Set QoS by <b>IP Address</b> or <b>MAC address</b>
<b>Local IP Address</b>	Set local IP Address if the address type is by IP Address
<b>MAC Address</b>	Set MAC Address if the address type is by MAC Address
<b>Mode</b>	Select <b>Guaranteed minimum bandwidth</b> or <b>Restricted maximum bandwidth</b>
<b>Bandwidth</b>	Key in the bandwidth.
<b>Comment</b>	Write your comment here.
<b>Apply Changes &amp; Reset</b>	Click on <b>Apply Changes</b> to save the setting data. Or you may click on <b>Reset</b> to clear all the input data.

## 5.2.2 Port Filtering

When enabled packets are denied access to Internet/filtered based on their port address.

### Port Filtering

Entries in this table are used to restrict certain types of data packets from your local network to Internet through the Gateway. Use of such filters can be helpful in securing or restricting your local network.

**Enable Port Filtering**

Port Range:  -  Protocol: **Both**  Comment:

**Both**  
TCP  
UDP

Current Filter Table:

Port Range	Protocol	Comment	Select
------------	----------	---------	--------

Item	Description
<b>Enable Port Filtering</b>	Select Enable Port Filtering to filter ports.
<b>Port Range</b>	Enter the port number that needs to be filtered.
<b>Protocol</b>	Please select the protocol type of the port.
<b>Comment</b>	You can add comments for this regulation.
<b>Apply Changes &amp; Reset</b>	Click on <b>Apply Changes</b> to save the setting data. Or you may click on <b>Reset</b> to clear all the input data.

<b>Current Filter Table</b>	It will display all ports that are filtering now.
<b>Delete Selected &amp; Delete All</b>	Click <b>Delete Selected</b> will delete the selected item. Click <b>Delete All</b> will delete all items in this table.
<b>Reset</b>	You can click <b>Reset</b> to cancel.

Port 80 has been blocked as the following illustrate.

IP: 192.168.1.x

Port: 80-80

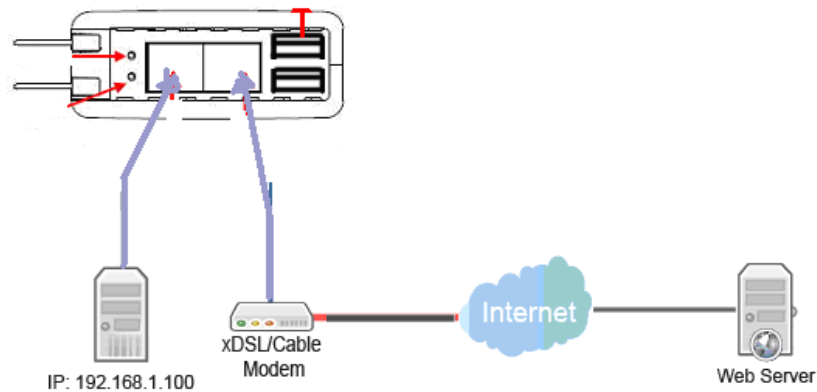

### 5.2.3 IP Filtering

When enabled, LAN clients are blocked / filtered from accessing the Internet based on their IP addresses.

#### IP Filtering

Entries in this table are used to restrict certain types of data packets from your local network to Internet through the Gateway. Use of such filters can be helpful in securing or restricting your local network.

Enable IP Filtering

Local IP Address:  Protocol:  Comment:

Apply Changes

Reset

Current Filter Table:

Local IP Address	Protocol	Comment	Select
------------------	----------	---------	--------

Delete Selected

Delete All

Reset

Item	Description
<b>Enable IP Filtering</b>	Please select Enable IP Filtering to filter IP addresses.
<b>Local IP Address</b>	Please enter the IP address that needs to be filtered.
<b>Protocol</b>	Please select the protocol type of the IP address
<b>Comment</b>	You can add comments for this regulation.
<b>Apply Changes &amp; Reset</b>	Click on <b>Apply Changes</b> to save the setting data. Or you may click on <b>Reset</b> to clear all the input data.
<b>Current Filter Table</b>	It will display all ports that are filtering now.
<b>Delete Selected &amp; Delete All</b>	Click <b>Delete Selected</b> will delete the selected item. Click <b>Delete All</b> will delete all items in this table.
<b>Reset</b>	You can click <b>Reset</b> to cancel.

## Chapter 6 Advanced Setup

You can find advanced settings in this section.

**Router** Router Mode only.

**AP** AP Mode only.

**WiFi-AP** WiFi AP Mode only.

### 6.1 Dynamic DNS Setting **Router**

You can assign a fixed host and domain name to a dynamic Internet IP address. Each time the router boots up, it will re-register its domain-name-to-IP-address mapping with the DDNS service provider. This is the way Internet users can access the router through a domain name instead of its IP address.

**Note:** make sure that you have registered with a DDNS service provider before enabling this feature.

### Dynamic DNS Setting

Dynamic DNS is a service, that provides you with a valid, unchanged, internet domain name (an URL) to go with that (possibly often changing) IP address.

Enable DDNS

Service Provider :  << dyndns ▾

Domain Name :

User Name/Email:

Password/Key:

*Note:*  
For TZO, you can have a 30 days free trial [here](#) or manage your TZO account in [control panel](#)  
For DynDNS, you can create your DynDNS account [here](#)

Please enter Domain Name, User Name/Email, and Password/Key. After entering, click on Apply Changes to save the setting, or you may click on Reset to clear all the input data.

Item	Description
<b>Enable/Disable DDNS</b>	Select enable to use DDNS function. Each time your IP address to WAN is changed, and the information will be updated to DDNS service provider automatically.
<b>Service Provider</b>	Choose correct Service Provider from drop-down list, here including DynDNS, TZO, ChangeIP, Eurodns, OVH, NO-IP, ODS, Regfish embedded in SAPIDO GR-1142.
<b>User Name/Email</b>	User name is used as an identity to login Dynamic-DNS service.

<b>Password/Key</b>	Password is applied to login Dynamic-DNS service.
<b>Apply Changes &amp; Reset</b>	Click on Apply Changes to save the setting data. Or you may click on Reset to clear all the input data.

## 6.2 Wireless Advanced Setup

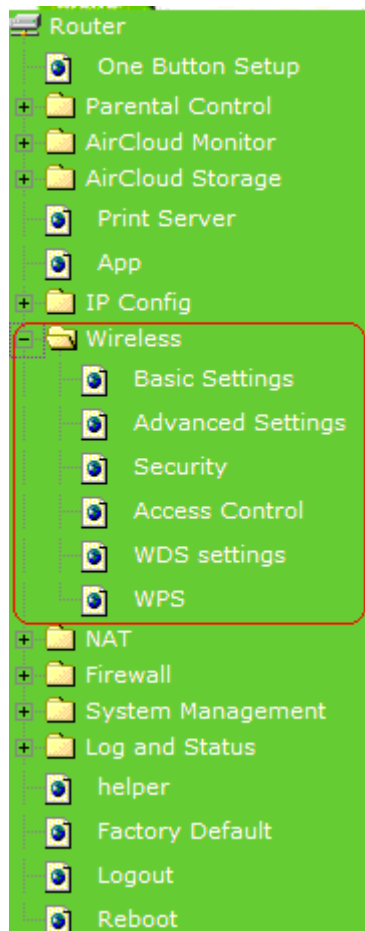

In Advanced Settings page, more 802.11 related parameters are tunable.

### Wireless Advanced Settings

These settings are only for more technically advanced users who have a sufficient knowledge about wireless LAN. These settings should not be changed unless you know what effect the changes will have on your Access Point.

---

**Fragment Threshold:**  (256-2346)  
**RTS Threshold:**  (0-2347)  
**Beacon Interval:**  (20-1024 ms)  
**Preamble Type:**  Long Preamble  Short Preamble  
**IAPP:**  Enabled  Disabled  
**Protection:**  Enabled  Disabled  
**Aggregation:**  Enabled  Disabled  
**Short GI:**  Enabled  Disabled  
**RF Output Power:**  100%  70%  50%  35%  15%

Item	Description
<b>Fragment Threshold</b>	To identify the maxima length of packet, the over length packet will be fragmented. The allowed range is 256-2346, and default length is 2346.
<b>RTS Threshold</b>	This value should remain at its default setting of 2347. The range is 0~2347. Should you encounter inconsistent data flow, only minor modifications are recommended. If a network packet is smaller than the present RTS threshold size, the RTS/CTS mechanism will not be enabled. The router sends Request to Send (RTS) frames to a particular receiving station and negotiates the sending of a data frame. After receiving an RTS, the wireless station responds with a Clear to Send (CTS) frame to acknowledge the right to begin transmission. Fill the range from 0 to 2347 into this blank.
<b>Beacon Interval</b>	Beacons are packets sent by an access point to synchronize a wireless network. Specify a beacon interval value. The allowed setting range is 20-1024 ms..
<b>Preamble Type</b>	PLCP is Physical layer convergence protocol and PPDU is PLCP protocol data unit during transmission, the PSDU shall be appended to a PLCP preamble and header to create the PPDU. It has 2 options: Long Preamble and Short Preamble.
<b>IAPP</b>	Inter-Access Point Protocol is a recommendation that describes an optional extension to IEEE 802.11 that provides wireless access-point communications among multivendor systems.
<b>Protection</b>	Please select to enable wireless protection or not.
<b>Aggregation</b>	Enable this function will combine several packets to one and transmit it. It can reduce the problem when mass packets are transmitting.
<b>Short GI</b>	Users can get better wireless transmission efficiency when they enable this function.
<b>RF Output Power</b>	Users can adjust RF output power to get the best wireless network environment. Users can choose from 100%, 70%, 50%, 35%, and

	15%.
<b>Apply Changes &amp; Reset</b>	Click on Apply Changes to save the setting data. Or you may click on Reset to clear all the input data.

### 6.2.1 Wireless Site Survey WiFi-AP

This function provides users to search existing wireless APs or wireless base stations from ISP. You can connect to a wireless AP manually in Wi-Fi AP mode. The designed AP will appear on SSID column in Wireless Basic Setup page.

Please click on Refresh to refresh the list. Click Connect after select an existing AP to connect.

#### Wireless Site Survey

This page provides tool to scan the wireless network. If any Access Point or IBSS is found, you could choose to connect it manually when client mode is enabled.

##### List of APs

SSID	BSSID	Channel	Type	Encrypt	Signal	Select
grr	00:40:f4:b7:02:03	1 (B)	AP	WEP	44	<input type="radio"/>
ka1eevriox	48:5b:39:15:3a:fc	6 (B+G)	AP	WPA-PSK/WPA2-PSK	20	<input type="radio"/>
xyy	00:e0:98:51:0e:24	11 (B)	AP	WEP	18	<input type="radio"/>

### 6.2.2 WDS Settings Router AP

When selected in the Basic Settings page and enabled here, Wireless Distribution System (WDS) enables the router to be used as a wireless bridge. Two Wireless-N Routers in bridge mode can communicate with each other through their wireless interfaces. To accomplish this, all wireless routers should be set to the same channel and the MAC address of other AP / Routers should be entered in the table.

The WDS explanation is as the following picture.

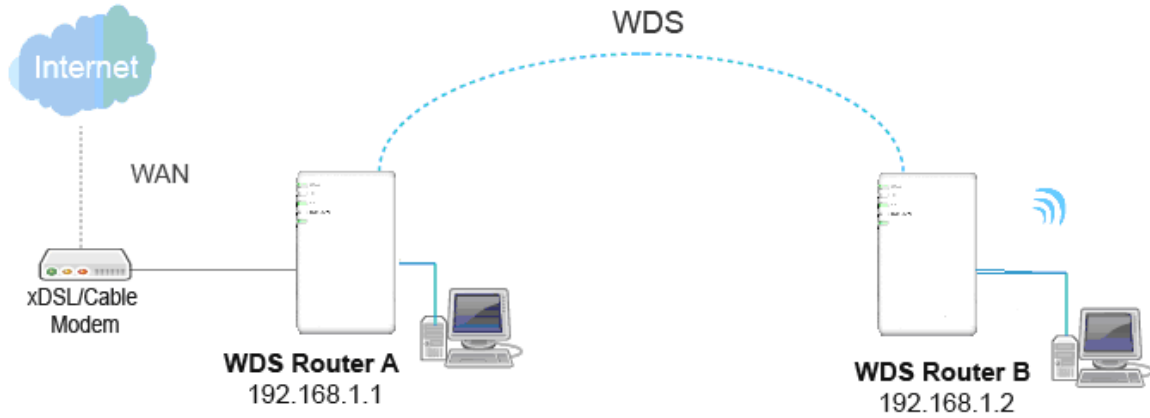

### Setup Router A

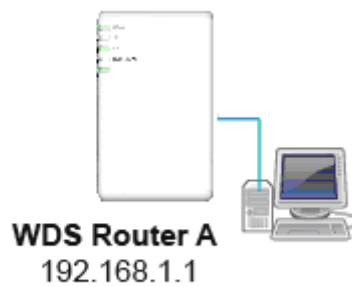

1. Please check the MAC address and Channel number from WDS Router A.

Wireless Configuration	
Mode	AP
Band	2.4 GHz (B+G+N)
SSID	SAPIDO_GR-1142
Channel Number	6
Encryption	Disabled
MAC Address	00:d0:41:ca:fe:b0
Associated Clients	1

2. Set the connection mode to “AP+WDS” from “Wireless Basic Setting”, and then select the channel number (in this example is “6”). Click Apply Changes to save the setting.

## Wireless Basic Settings

This page is used to configure the parameters for wireless LAN clients which may connect to your Access Point. Here you may change wireless encryption settings as well as wireless network parameters.

Disable Wireless LAN Interface

Band: 2.4 GHz (B+G+N) ▾

Mode: AP+WDS ▾

Network Type: Infrastructure ▾

SSID: SAPIDO\_GR-1142

Channel Width: Auto ▾ ( 40MHz provides the fastest data transmission rate, however, if the wireless signal is unstable, such as in Hong Kong, please select the setting to auto. )

Control Sideband: Upper ▾

Channel Number: 6 ▾

Broadcast SSID: Enabled ▾

WMM: Enabled ▾

Data Rate: Auto ▾

Associated Clients:

Enable Mac Clone (Single Ethernet Client)

Enable Universal Repeater Mode (Acting as AP and client simultaneously)

SSID of Extended Interface: ESSID\_SAPIDO\_GR-1142

3. Enable WDS function from the page – “WDS Setting”, and then fill in the MAC address of Router B. Click Apply Changes to save the setting data.

### WDS Settings

Wireless Distribution System uses wireless media to communicate with other APs, like the Ethernet does. To do this, you must set these APs in the same channel and set MAC address of other APs which you want to communicate with in the table and then enable the WDS.

Enable WDS

MAC Address: 000e68ff05c8

Data Rate: Auto ▾

Comment:

WDS Security Setup:

MAC Address	Tx Rate (Mbps)	Comment	Select
<input type="button" value="Delete Selected"/> <input type="button" value="Delete All"/> <input type="button" value="Reset"/>			

- The WDS AP List will show the WDS device MAC address after reboot.

### WDS Settings

Wireless Distribution System uses wireless media to communicate with other APs, like the Ethernet does. To do this, you must set these APs in the same channel and set MAC address of other APs which you want to communicate with in the table and then enable the WDS.

---

**Enable WDS**

MAC Address:

Data Rate:

Comment:

**WDS Security Setup:**

MAC Address	Tx Rate (Mbps)	Comment	Select
00:0e:68:ff:05:c8	Auto		<input type="checkbox"/>

- Move on the setup to WDS Router B

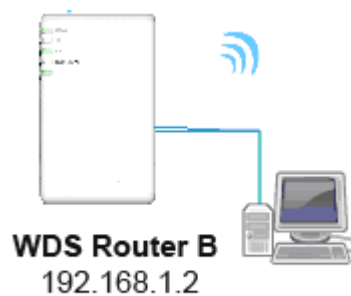

### WDS Settings

Wireless Distribution System uses wireless media to communicate with other APs, like this, you must set these APs in the same channel and set MAC address of other APs which communicate with in the table and then enable the WDS.

**Enable WDS**

MAC Address:  ⇒ Input Router A's MAC address here.

Data Rate:

Comment:

**WDS Security Setup:**

MAC Address	Tx Rate (Mbps)	Comment	Select
-------------	----------------	---------	--------

6. You will receive an IP address from Router A.

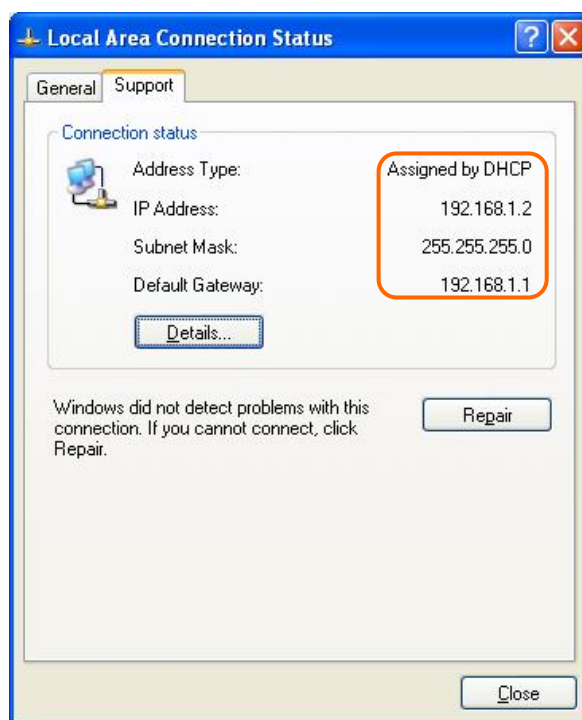

If you failed the WDS setting, please check you setting with refer to the list below.

	Router A	Router B
Mode	Router	AP
LAN IP Address	Set the same segment as the router B(Note 1) Example :192.168.1.1	Set the same segment as the router A(Note 1) Example :192.168.1.2
Security	Set the same security as Router B	Set the same security as Router A
DHCP	Enable	Disable

Note 1: LAN IP address should be under the same segment but cannot be the same number.

### 6.2.3 WPS Router AP

This page allows user to change the setting for WPS (Wi-Fi Protected Setup). Using this feature could let your wireless client atomically synchronize it's setting and connect to the Access Point in a minute without any hassle. SAPIDO GR-1142 could support both Self-PIN or PBC modes, or use the WPS button (at real panel) to easy enable the WPS function.

**PIN model**, in which a PIN has to be taken either from a sticker label or from the web interface of the WPS device. This PIN will then be entered in the AP or client WPS device to connect.

**PBC model**, in which the user simply has to push a button, either an actual or a virtual one,

on both WPS devices to connect.

Please follow instructions below to enable the WPS function.

### 1. Setup Wireless LAN with WPS PIN :

- (1). Get the WPS PIN number from wireless card and write it down.



- (2). Fill in the PIN number from the wireless card in Client PIN Number field, and then click "Start PIN".

### Wi-Fi Protected Setup

This page allows you to change the setting for WPS (Wi-Fi Protected Setup). Using this feature could let your wireless client automatically synchronize its setting and connect to the Access Point in a minute without any hassle.

**Disable WPS**

Self-PIN Number: 13021412

Push Button Configuration:

Client PIN Number:

Current Key Info:

Authentication	Encryption	Key
Open	None	N/A

**Applied client's PIN successfully!**

**You have to run Wi-Fi Protected Setup in client within 2 minutes.**

- (3). Click PIN from Adapter Utility to complete the WPS process with the wireless router.



**2. Start PBC:**

- (1). Press the WPS button (A) from SAPIDO GR-1142 and wait for Wireless/WPS LED light (B) changed into orange.
- (2). Press the WPS button (C) from the adapter until the setup window shows up.

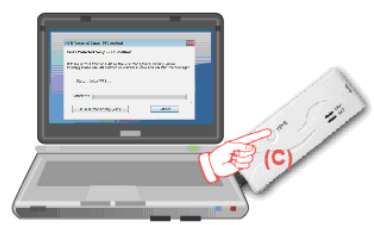
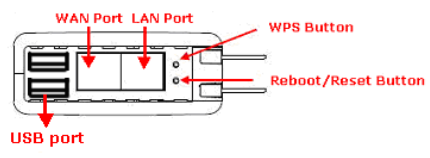

- (3). Open a web browser to check the internet connection.

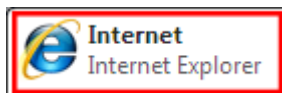

Please also refer to section 4.1.1 WPS setup for more details.

## 6.3 System Management

This section including **Walk on Lan Schedule, Change Password, Firmware Upgrade, Profiles Save, Time Zone Setting, UPnP Setting, VPN Passthrough Setting, and Language Setting**. It is easy and helpful for users making more detailed settings.

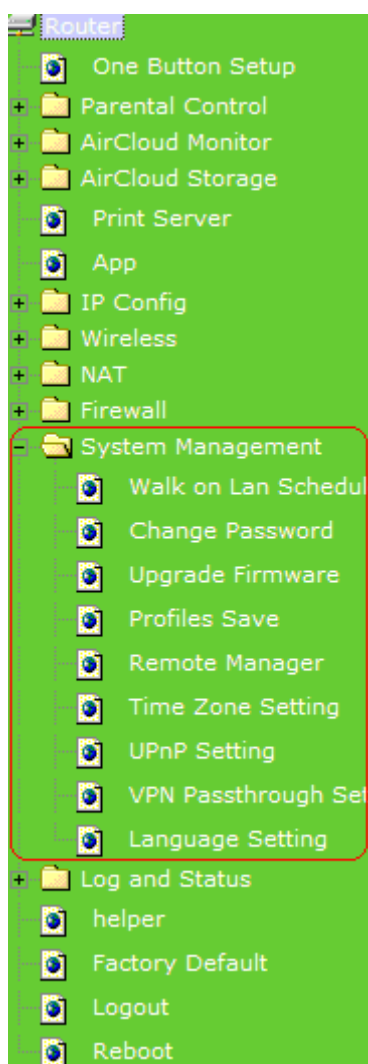

### 6.3.1 Walk on LAN Schedule

Switch your computer ON through your LAN or the Internet . To support WOL you must have a computer with Motherboard that supports WOL, as well as a Network Controller (NIC) supporting this function. Most of the newer Motherboard (circa 2002 and On), have an On Board NIC that supports WOL. Otherwise you need to install a PCI NIC that is WOL capable.

## Walk on Lan Schedule

This page allows you setup the Walk on LAN schedule rule. Please do not forget to configure system time and select PC MAC address before enable this feature.

**Enable Walk on LAN Schedule**

Enable	Day	Time		MAC Address
<input checked="" type="checkbox"/>	Sun ▾	00 ▾ (hour)	00 ▾ (min)	00:10:23:25:AA:CF ▾
<input checked="" type="checkbox"/>	Sun ▾	00 ▾ (hour)	00 ▾ (min)	00:10:23:25:AA:CF ▾
<input checked="" type="checkbox"/>	Sun ▾	00 ▾ (hour)	00 ▾ (min)	00:10:23:25:AA:CF ▾
<input checked="" type="checkbox"/>	Sun ▾	00 ▾ (hour)	00 ▾ (min)	00:10:23:25:AA:CF ▾
<input checked="" type="checkbox"/>	Sun ▾	00 ▾ (hour)	00 ▾ (min)	00:10:23:25:AA:CF ▾
<input checked="" type="checkbox"/>	Sun ▾	00 ▾ (hour)	00 ▾ (min)	00:10:23:25:AA:CF ▾
<input checked="" type="checkbox"/>	Sun ▾	00 ▾ (hour)	00 ▾ (min)	00:10:23:25:AA:CF ▾
<input checked="" type="checkbox"/>	Sun ▾	00 ▾ (hour)	00 ▾ (min)	00:10:23:25:AA:CF ▾
<input checked="" type="checkbox"/>	Sun ▾	00 ▾ (hour)	00 ▾ (min)	00:10:23:25:AA:CF ▾
<input checked="" type="checkbox"/>	Sun ▾	00 ▾ (hour)	00 ▾ (min)	00:10:23:25:AA:CF ▾

Apply Change

Reset

### 6.3.2 Change Password

Users can set or change user name and password used for accessing the web management interface in this section.

### Change Password

This page is used to set the account to access the web server of Access Point. Empty user name and password will disable the protection.

---

User Name:

New Password:

Confirmed Password:

Apply Change    Reset

Click on Apply Changes to save the setting data. Or you may click on Reset to clear all the input data.

### 6.3.3 Firmware Upgrade

This function can upgrade the firmware of the router. There is certain risk while doing firmware upgrade. Firmware upgrade is not recommended unless the significant faulty is found and published on official website. If you feel the router has unusual behaviors and is not caused by the ISP and environment. You can check the website (<http://www.amigo.com.tw>) to see if there is any later version of firmware. Download the firmware to your computer, click Browser and point to the new firmware file. Click Upload to upgrade the firmware. You can't make any move unless the machine reboot completely.

#### Firmware Upgrade

This page allows you upgrade the Access Point firmware to new version. Please note, do not power off the device during the upload because it may crash the system.

Select File:  No file chosen

**Caution:** To prevent that firmware upgrading is interrupted by other wireless signals and causes failure. We recommend users to use wired connection during upgrading.

**Note:** The firmware upgrade will not remove your previous settings.

#### λ Reset button:

On the front of this router, there is a reset button. If you cannot login the administrator page by forgetting your password; or the router has problem you can't solve. You can push the reset button for 5 seconds with a stick. The router will reboot and all settings will be restored to factory default settings. If the problem still exists, you can visit our web site to see if there is any firmware for download to solve the problem.

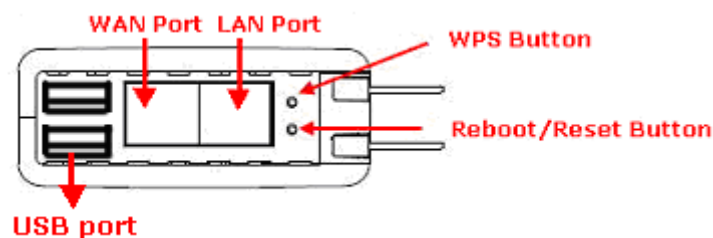

### 6.3.4 Profile Save

Users can create a backup file that contains current router settings. This backup file can be used to restore router settings. This is especially useful in the event you need to reset the

router to its default settings.

## 1. Save Configuration

(1). Click Save

### Save/Reload Settings

This page allows you save current settings to a file or reload the settings from the file which was saved previously. Besides, you could reset the current configuration to factory default.

Save Settings to File:

Load Settings from File:  No file chosen

Reset Settings to Default:

(2). Please click "Save" to save the configuration to your computer.



(3). Select the location which you want to save file, then click Save.

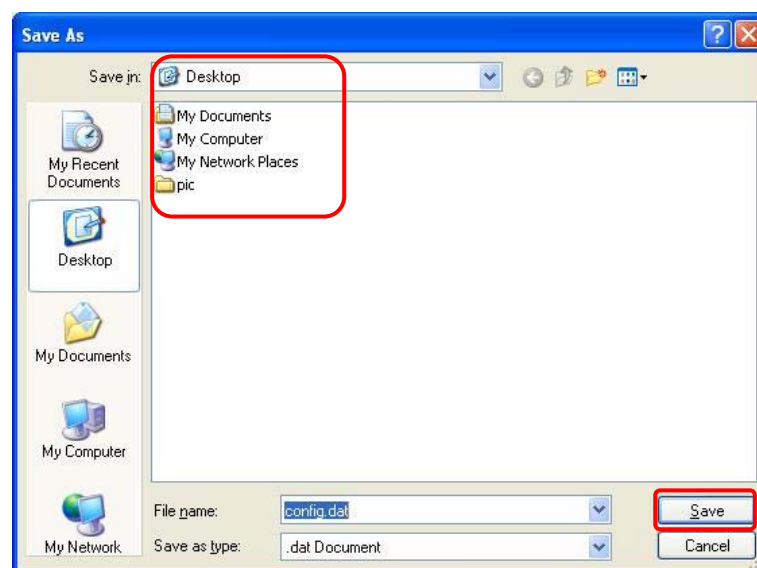

## 2. Load configuration file

- (1). Click Choose File

## Save/Reload Settings

This page allows you save current settings to a file or reload the settings from the file which was saved previously. Besides, you could reset the current configuration to factory default.

Save Settings to File:

Load Settings from File:  No file chosen

Reset Settings to Default:

- (2). Select configuration file then click Open

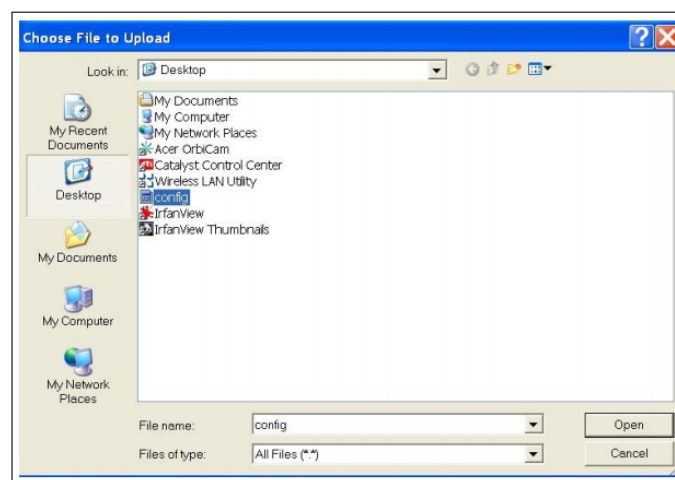

- (3). Click Upload to upload configuration file to SAPIDO GR-1142.

## Save/Reload Settings

This page allows you save current settings to a file or reload the settings from the file which was saved previously. Besides, you could reset the current configuration to factory default.

Save Settings to File:

Load Settings from File:  config.dat

Reset Settings to Default:

- (4). After 90 seconds, SAPIDO GR-1142 will reboot automatically.

3. Reload factory default setting

- (1). Please click Reset

## Save/Reload Settings

This page allows you save current settings to a file or reload the settings from the file which was saved previously. Besides, you could reset the current configuration to factory default.

Save Settings to File:

Load Settings from File:  No file chosen

Reset Settings to Default:

(2). Please click OK to start reload factory default setting to SAPIDO GR-1142.

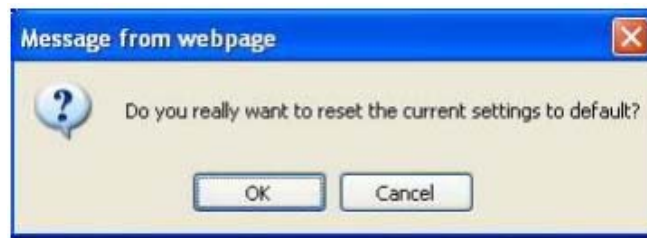

(3). After 90 seconds, SAPIDO GR-1142 will reboot automatically.

### 6.3.5 Remote Manager

## Remote manager

This page allow you to access the GUI on WAN.

HTTP Connection Port:

Enable Web Server Access on WAN:  ▾

Item	Description
HTTP Connection Port	Users can access GUI by this port , default is 80
<b>Enable Web Server Access on WAN</b>	Allow user access GUI from WAN side

### 6.3.6 Time Zone Setting

Users can synchronize the local clock on the router to an available NTP server (optional). To complete this setting, enable NTP client update and select the correct Time Zone.

Item	Description
<b>Current Time</b>	Users can input the time manually.
<b>Time Zone Select</b>	Please select the time zone.
<b>Enable NTP client update</b>	Please select to enable NTP client update or not.
<b>Automatically Adjust Daylight Saving</b>	Please select to enable Automatically Adjust Daylight Saving or not.
<b>NTP Server</b>	Please select the NTP server from the pull-down list, or you can enter the NTP server IP address manually.
<b>Apply Changes &amp; Reset &amp; Refresh</b>	Please click on Apply Changes to save the setting data. Or you may click on Reset to clear all the input data. Or you may click on Refresh to update the system time on the screen.

### 6.3.7 UPnP Setting

Universal Plug and Play (UPnP) is a standard of networking protocols promulgated by the UPnP Forum. The goals of UPnP are to allow devices to connect seamlessly and to simplify the implementation of networks in the home (data sharing, communications, and entertainment) and in corporate environments for simplified installation of computer components. SAPIDO GR-1142 supports UPnP function, and can cooperate with other UPnP devices. When you activate UPnP, please click My Network Places. Users will see an Internet Gateway Device icon. By click the icon, users can enter the GUI of the router. If you do not

wish to use UPnP, you can disable it.

### UPnP Setting

In this page, you can turn on or turn off the UPnP feature of your router.

---

**Enable/Disable UPnP:**                       **Enabled**    **Disabled**

Apply Change
Reset

**Enable/Disable UPnP:** Select to enable or disable this function.

### 6.3.8 VPN Passthrough Setting

Virtual Private Networking (VPN) is typically used for work-related networking. For VPN tunnels, the router supports IPSec, Pass-through, PPTP Pass-through, and L2TP Pass-through.

### VPN Passthrough Setting

In this page, you can turn on or turn off the VPN Passthrough feature of your router.

---

**Enable/Disable IPSec Passthrough::**                       **Enabled**    **Disabled**

**Enable/Disable PPTP Passthrough::**                       **Enabled**    **Disabled**

**Enable/Disable L2TP Passthrough::**                       **Enabled**    **Disabled**

Apply Change
Reset

Item	Description
<b>IPSec Pass-through</b>	Internet Protocol Security (IPSec) is a suite of protocols used to implement secure exchange of packets at the IP layer. To allow IPSec tunnels to pass through the router, IPSec Pass-through is enabled by default. To disable IPSec Pass-through, select Disable
<b>PPTP Pass-through</b>	Point-to-Point Tunneling Protocol is the method used to enable VPN sessions to a Windows NT 4.0 or 2000 server. To allow PPTP tunnels to pass through the router, PPTP Pass-through is enabled by default. To disable PPTP Pass-through, select Disable.
<b>L2TP Pass-through</b>	To allow the L2TP network traffic to be forwarded to its destination without the network address translation tasks.

**Apply Changes & Reset & Refresh**

Please click on Apply Changes to save the setting data. Or you may click on Reset to clear all the input data.

### 6.3.9 Language Setting

The SAPIDO GR-1142 provide 12 language for Web GUI. You can select the language interface from the dropdown list and by following steps.

#### Language Setting

This page allows you setup the GUI language.

Select language:

- English
- 繁體中文
- 简体中文
- 日本語
- Русский
- Deutsch
- Français
- العربية
- Español
- Português
- 한국어
- Italiano

When you see the screen message change to the selected language, the setup is completed.

**Sprache einstellen**

Auf dieser Seite können Sie die GUI-Setup-Sprache.

Wählen Sie die Sprache:

### 6.4 Log & Status

The category provides Network Config and Event Log status for users to know the operation status.

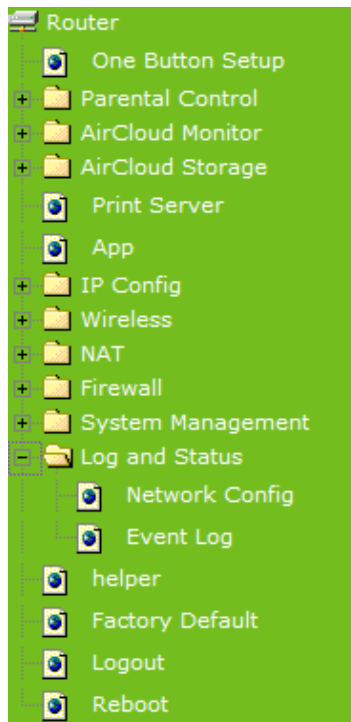

### 6.4.1 Network Config

Users can check the Internet status under this category, including Firmware version, Wireless setting, Connecting Time, WAN, TCP/IP ...information.

#### Network Config

This page shows the current status and some basic settings of the device.

<b>System</b>	
Uptime	0day:2h:55m:3s
Firmware Version	Ver1.1.32
Build Time	Wed Feb 8 21:18:53 CST 2012
<b>Wireless Configuration</b>	
Mode	AP
Band	2.4 GHz (B+G+N)
SSID	SAPIDO_GR-1142
Channel Number	6
Encryption	Disabled
MAC Address	00:d0:41:ca:fe:b0
Associated Clients	1
<b>WirelessRepeater Interface Configuration</b>	
Mode	Infrastructure Client
ESSID	ESSID_SAPIDO_GR-1142
Encryption	Disabled
MAC Address	00:00:00:00:00:00
State	Scanning
<b>LAN Configuration</b>	
Attain IP Protocol	Fixed IP
IP Address	192.168.1.1
Subnet Mask	255.255.255.0
Default Gateway	192.168.1.1
MAC Address	00:d0:41:ca:fe:b0
<b>WAN Configuration</b>	
Attain IP Protocol	Fixed IP Connected
IP Address	192.168.2.81
Subnet Mask	255.255.255.0
Default Gateway	192.168.2.1
MAC Address	00:d0:41:ca:fe:b1
DNS1	168.95.1.1
DNS2	
DNS3	

## 6.4.2 Event Log

You may enable the event log feature here.

Item	Description
<b>Enable Log</b>	You may choose to enable Event Log or not.
<b>System all, Wireless, &amp; DoS</b>	Please select the event you want to record.
<b>Enable Remote Log</b>	You may choose to enable the remote event log or not.
<b>Log Server IP Address</b>	Please input the log server IP Address.
<b>Apply Changes &amp; Refresh &amp; Clear</b>	Click on Apply Changes to save the setting data. Click on Refresh to renew the system time, or on Clear to clear all the record.

\* The following figure is an example when users click Apply Changes to record the event log.

## 6.5 Logout

This function logs out the user.

**Logout**

This page is used to logout.

**Do you want to logout ?**

## 6.6 App

### App

---

#### APP Link

**Free - Support  
read/write**



**Free - Only for view**



**Pay - Full-Featured**



#### FTP Client Download

**Windows**



**MAC**



**Linux**



Hyperlinks provide users quick and convenient for users to download with a third-party software on the machine

## Chapter 7 Samba Server

The SAPIDO GR-1142 is able to act as a Samba server to share the file on USB storage in local network.

### 7.1 How to use SAPIDO GR-1142 as a Samba server

1. Plug in the USB hard disk/Flash.

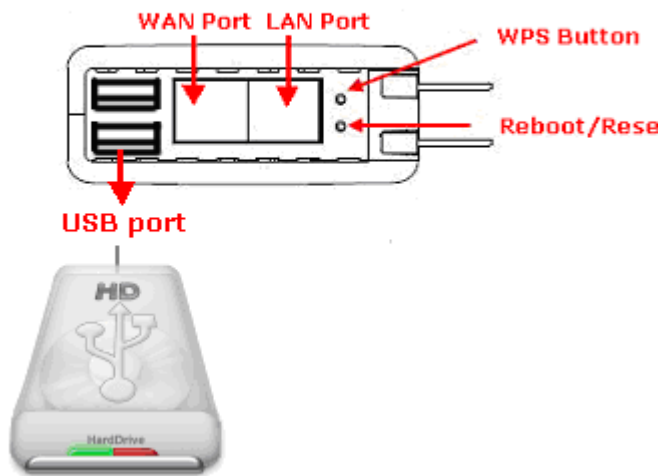

2. Start your web browser and input [\\192.168.1.1](http://192.168.1.1).



3. Start "My Computer" and you will find a folder named "sda1".

#### The Internet



### 7.2 Air play

- Connect device to router



● **Execute ipod**

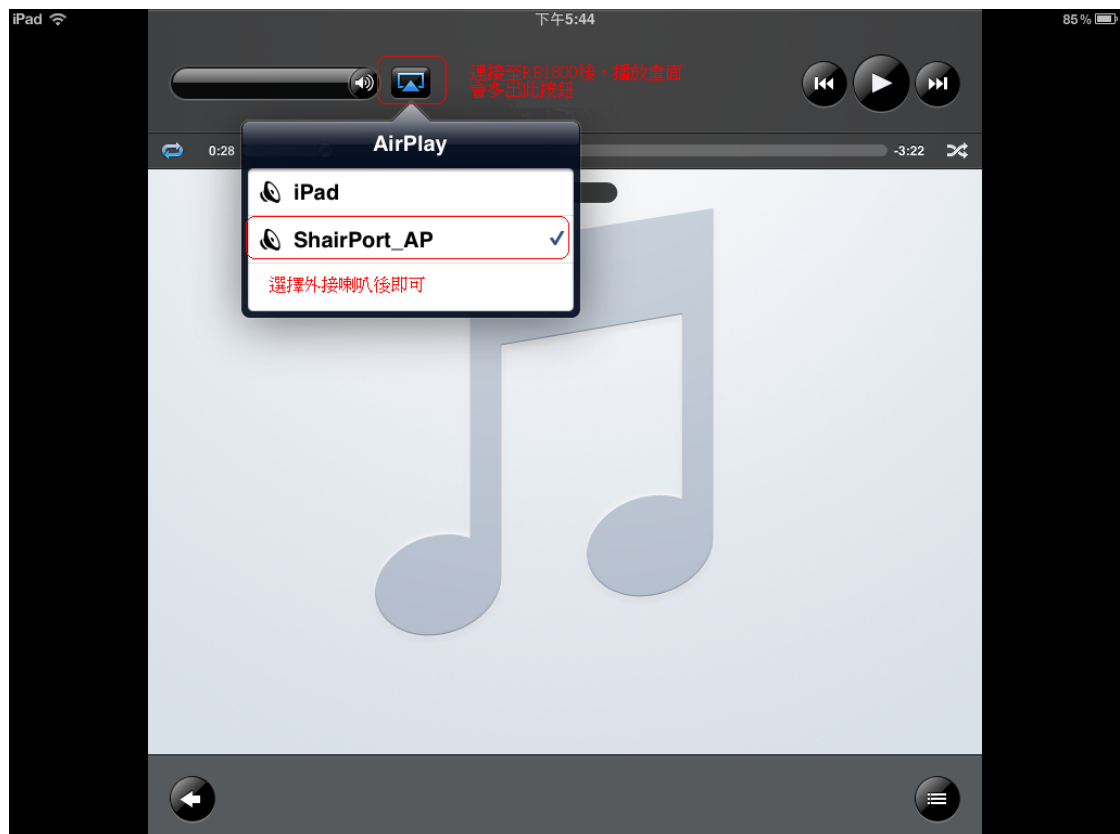

## 7.3 Printer Server

### To add an LPR port

1. Open Printers and Faxes.
2. Double-click **Add Printer** to open the Add Printer Wizard, and then click **Next**.
3. Click **Local printer attached to this computer**, clear the **Automatically detect and install my Plug and Play printer** check box, and then click **Next**.
4. Click **Create a new port**, and then click **LPR Port**.

If **LPR Port** is not available, click **Cancel** to stop the wizard. To add the LPR port, you need to install the optional networking component, **Print Services for Unix**. For more information, click **Related Topics**.

5. Click **Next**, and then provide the following information:
  - In **Name or address of server providing LPD**, type the Domain Name System (DNS) name or Internet Protocol (IP) address of the host for the printer you are adding. The host may be the direct-connect TCP/IP printing device or the UNIX computer to which the printing device is connected. The DNS name can be the name specified for the host in the Hosts file.
  - In **Name of printer or print queue on that server**, type the name of the printer as it is identified by the host, which is either the direct-connect printer itself or the UNIX computer.
6. Follow the instructions on the screen to finish installing the TCP/IP printer.

### Notes

- To open Printers and Faxes, click **Start**, and then click **Printers and Faxes**.
- The Line Printer Remote (LPR) port is best suited to servers that need to communicate with host computers (such as UNIX or VAX computers) by way of RFC 1179.
- A network-connected printer must have a card that supports LPD for LPR printing to work properly.

- You can also add ports using the **Print Server Properties** dialog box. For more information, click **Related Topics**.
- Please refer DUT/Network Config page to get name of printer

LAN Configuration	
Attain IP Protocol	Fixed IP
IP Address	192.168.1.1
Subnet Mask	255.255.255.0
Default Gateway	192.168.1.1
MAC Address	00:e0:4c:5a:4e:87
WAN Configuration	
Attain IP Protocol	DHCP
IP Address	192.168.10.166
Subnet Mask	255.255.255.0
Default Gateway	192.168.10.1
MAC Address	00:e0:4c:5a:4e:8f
3.5G Configuration	
Connect Speed	Auto Switch
Signal Strength	
Network Name	
Printer Configuration	
Printer Server	Enable
Printer Name	DeskJet 940C
Printer Model	Hewlett-Packard

## Chapter 8 DDNS Service Application

DDNS is a service changes the dynamic IP to the static IP. The settings of DDNS can solve the problem of being given the different IP by router every time. After setting the Router, your host name would correspond to your dynamic IP. Moreover, via the host name application, it could be easier for you to use FTP, Webcam and Printer remotely.

Dynamic DNS allows you to make an assumed name as a dynamic IP address to a static host name. Please configure the dynamic DNS below. Please select **Dynamic DNS** under the **IP Config** folder, and follow the instructions below to enter the **Dynamic DNS** page to configure the settings you want.

If you don't have a DDNS account, please follow the steps to complete your DDNS with Dynamic IP settings.

1. First access the Internet and fill <http://www.dyndns.com/> into the address field of your web browser, then click **Create Account**.

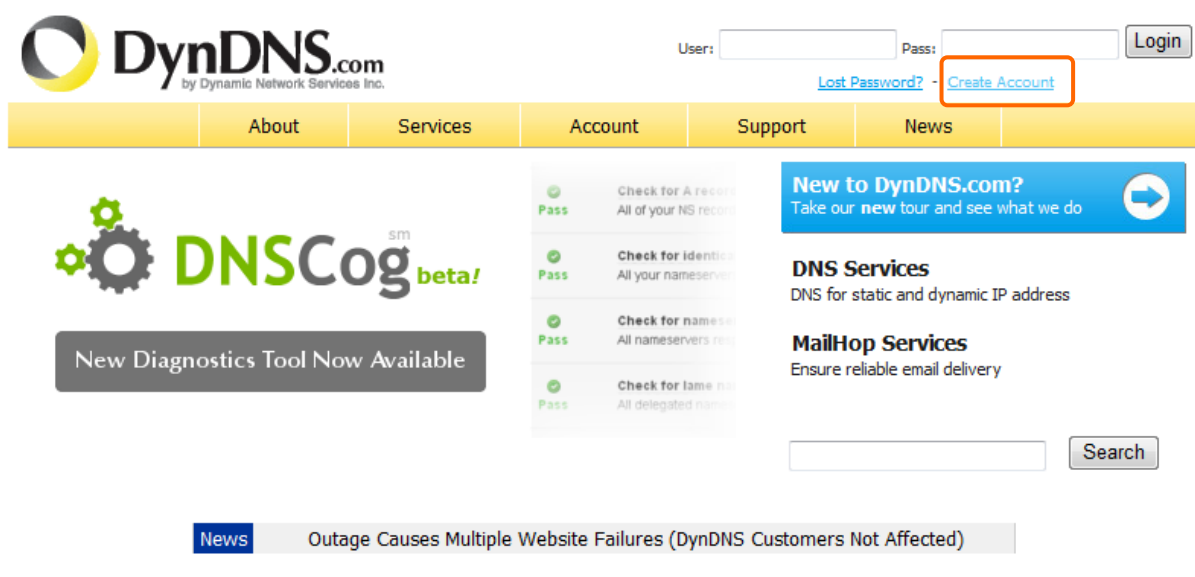

The screenshot shows the DynDNS.com website. At the top right, there are input fields for 'User:' and 'Pass:', a 'Login' button, and links for 'Lost Password?' and 'Create Account'. The 'Create Account' link is highlighted with a red rectangular box. Below the navigation bar, there is a 'New to DynDNS.com?' banner with a right-pointing arrow. The main content area includes 'DNSCog beta!' with a gear icon and a 'New Diagnostics Tool Now Available' button. A list of system checks is visible, all marked 'Pass'. To the right, there are sections for 'DNS Services' and 'MailHop Services'. At the bottom, a 'News' section is titled 'Outage Causes Multiple Website Failures (DynDNS Customers Not Affected)'. A search bar is located at the bottom right.

2. Fill in the form as required, and then click on **Create Account** button.

## Create Your DynDNS Account

Please complete the form to create your free DynDNS Account.

User Information	
Username:	<input type="text"/>
E-mail Address:	<input type="text"/> Instructions to activate your account will be sent to the e-mail address provided.
Confirm E-mail Address:	<input type="text"/>
Password:	<input type="text"/> Your password needs to be more than 5 characters and cannot be the same as your username. Do not choose a password that is a common word, or can otherwise be easily guessed.
Confirm Password:	<input type="text"/>

### About You (optional)

Providing this information will help us to better understand our customers, and tailor future offerings more accurately to your needs. Thanks for your help!

How did you hear about us:	<input type="text" value="---"/>	We <a href="#">do not sell</a> your account information to anyone, including your e-mail address.
Details:	<input type="text"/>	

### Terms of Service

Please read the acceptable use policy (AUP) and accept it prior to creating your account. Also acknowledge that you may only have one (1) free account, and that creation of multiple free accounts will result in the deletion of all of your accounts.

Policy Last Modified: February 6, 2006

1. ACKNOWLEDGMENT AND ACCEPTANCE OF TERMS OF SERVICE

All services provided by Dynamic Network Services, Inc. ("DynDNS") are provided to you (the "Member") under the Terms and Conditions set forth in this Acceptable Use Policy ("AUP") and any other operating rules and policies set forth by DynDNS. The AUP comprises the entire agreement between the Member and DynDNS and supersedes all prior agreements between the parties regarding the subject matter contained herein. BY COMPLETING THE REGISTRATION PROCESS AND CLICKING THE "Accept" BUTTON, YOU ARE INDICATING YOUR AGREEMENT TO BE BOUND BY ALL OF THE TERMS AND CONDITIONS OF THE AUP.

2. DESCRIPTION OF SERVICE

I agree to the AUP:	<input checked="" type="checkbox"/>
I will only create one (1) free account:	<input checked="" type="checkbox"/>

### - Mailing Lists (optional)

DynDNS maintains a number of mailing lists designed to keep our users informed about product announcements, client development, our company newsletter, and our system status. Please use the checkboxes below to alter your subscription preference. Your subscription preference may be changed at any time through the [account settings](#) page.

newsletters:	<input type="checkbox"/>
press-releases:	<input type="checkbox"/>
system-status:	<input type="checkbox"/>

### - Next Step

After you click "Create Account", we will create your account and send you an e-mail to the address you provided. Please follow the instructions in that e-mail to confirm your account. You will need to confirm your account within 48 hours or we will automatically delete your account. (This helps prevent unwanted robots on our systems)

3. When you got this account created message, close it, and check your mailbox. You would get a mail from DynDNS website.

The screenshot shows the DynDNS website interface. At the top left is the DynDNS logo. To the right are input fields for 'User:' and 'Pass:' with a 'Login' button. Below these are links for 'Lost Password?' and 'Create Account'. A yellow navigation bar contains links for 'About', 'Services', 'Account', 'Support', and 'News'. On the left side, there is a 'My Account' menu with options: 'Create Account', 'Login', and 'Lost Password?'. Below the menu is a search box with a 'Search' button. The main content area has a grey header 'Account Created' followed by a message: 'Your account, TYatLab, has been created. Directions for activating your account have been sent to your e-mail address: clairbleu\_ty@hotmail.com. To complete registration, please follow the directions you receive within 48 hours. You should receive the confirmation e-mail within a few minutes. Please make certain that your spam filtering allows messages from support@dyndns.com to be delivered. If you have not received this e-mail within an hour or so, request a [password reset](#). Following the instructions in the password reset e-mail will also confirm your new account. Thanks for using DynDNS!'.

4. Click on the indicated address within your mail to confirm.

Your DynDNS Account 'TYatLab' has been created. You need to visit the confirmation address below within 48 hours to complete the account creation process:

[https://www.dyndns.com/account/confirm/Z3OpStScjR\\_Ypn82CNMyZQ](https://www.dyndns.com/account/confirm/Z3OpStScjR_Ypn82CNMyZQ)

Our basic service offerings are free, but they are supported by our paid services. See <http://www.dyndns.com/services/> for a full listing of all of our available services.

If you did not sign up for this account, this will be the only communication you will receive. All non-confirmed accounts are automatically deleted after 48 hours, and no addresses are kept on file. We apologize for any inconvenience this correspondence may have caused, and we assure you that it was only sent at the request of someone visiting our site requesting an account.

Sincerely,  
The DynDNS Team

- Click on **login**.

## Account Confirmed

The account TYatLab has been confirmed. You can now [login](#) and start using your account.

Be informed of new services, changes to services, and important system maintenance/status notifications by subscribing to our [mailing lists](#). Once there, you may subscribe to the Announce list by checking the appropriate box and clicking the "Save Settings" button.

- Click **My Services** after logging in.

- Click **Add New Hostname**.

## Account Level Services

<b>Paid Account</b> (?)	No	<a href="#">Technical Support</a>
<b>Account Upgrades</b> (?)	No	<a href="#">View - Add</a>
<b>DNS Service Level Agreement</b> (?)	None	<a href="#">Add DNS Service Level Agreement</a>
<b>Premier Support Option</b> (?)	None Available	<a href="#">Add Premier Support Cases</a>

## Zone Level Services

[Add Zone Services](#)

No zone level service items registered: [Add Zone Services](#).

## Hostnames

[Add New Hostname](#)

No Hostname services registered.

- Put in your favorite hostname and service type, and then click **Create Host** after finished.

**Hostname:**  .

**Wildcard:**  Yes, alias "\*.hostname.domain" to same settings.

**Service Type:**
 Host with IP address  
 WebHop Redirect  
 Offline Hostname

**IP Address:**   
Use auto detected IP address 210.68.117.196.  
 TTL value is 60 seconds. [Edit TTL.](#)

**Mail Routing:**  Yes, let me configure Email routing.

9. Your hostname has been created when you see the following page.

[Add New Hostname](#) - [Host Update Logs](#)

## Host Services

Hostname [amigo.webhop.net](#) created.

Hostname	Service	Details	Last Updated
<a href="#">amigo.webhop.net</a>	Host	210.68.117.196	Nov. 19, 2007 4:08 AM

## Chapter 9 Q & A

### 9.1 Installation

**1. Q: Where is the XDSL Router installed on the network?**

A: In a typical environment, the Router is installed between the XDSL line and the LAN. Plug the XDSL Router into the XDSL line on the wall and Ethernet port on the Hub (switch or computer).

**2. Q: Why does the throughput seem slow?**

A: To achieve maximum throughput, verify that your cable doesn't exceed 100 meter. If you have to do so, we advise you to purchase a bridge to place it in the middle of the route in order to keep the quality of transmitting signal. Out of this condition you would better test something else.

- Verify network traffic does not exceed 37% of bandwidth.
- Check to see that the network does not exceed 10 broadcast messages per second.
- Verify network topology and configuration.

### 9.2 LED

**1. Why doesn't SAPIDO GR-1142 power up?**

A: Check if the output voltage is suitable, or check if the power supply is out of order.

**2. The Internet browser still cannot find or connect to SAPIDO GR-1142 after verifying the IP address and LAN cable, the changes cannot be made, or password is lost.**

A: In case SAPIDO GR-1142 is inaccessible; you can try to restore its factory default settings. Please press the "Reset" button and keep it pressed for over 7 seconds and the light of STATUS will vanish. The LEDs will flash again when reset is successful.

**3. Why does SAPIDO GR-1142 shut down unexpectedly?**

A: Re-plug your power adapter. Then, check the STATUS indicator; if it is off, the internal flash memory is damaged. For more help, please contact with your provider.

### 9.3 IP Address

**1. Q: What is the default IP address of the router for LAN port?**

A: The default IP address is 192.168.1.1 with subnet mask 255.255.255.0

**2. Q: I don't know my WAN IP.**

A: There are two ways to know.

Way 1: Check with your Internet Service Provider.

Way 2: Check the setting screen of SAPIDO GR-1142. Click on **Status & Log** item to select **Network Configuration** on the Main Menu. WAN IP is shown on the WAN interface.

**3. How can I check whether I have static WAN IP Address?**

A: Consult your ISP to confirm the information, or check Network Configuration in SAPIDO GR-1142 's Main Menu.

**4. Will the Router allow me to use my own public IPs and Domain, or do I have to use the IPs provided by the Router?**

A: Yes, the Router mode allows for customization of your public IPs and Domain.

## **9.4 OS Setting**

**1. Why can't my computer work online after connecting to SAPIDO GR-1142?**

A: It's possible that your Internet protocol (TCP/IP) was set to use the following IP address. Please do as the following steps. (Windows 2000 & XP) **Start > Settings > Network and Dial-up Connections >** double click on **Internet Protocol(TCP/IP) >** select **obtain IP address automatically >** Click on **OK** button. Then, open Internet browser for testing. If you still can't go online, please test something else below.

- Verify network configuration by ensuring that there are no duplicate IP addresses.
- Power down the device in question and ping the assigned IP address of the device. Ensure no other device responds to that address.
- Check that the cables and connectors or use another LAN cable.

**2. Q: Why can't I connect to the router's configuration utility?**

A: Possible Solution 1: Make sure that your Ethernet connect properly and securely. Make sure that you've plugged in the power cord.

Possible Solution 2: Make sure that your PC is using an IP address within the range of 192.168.1.2 to 192.168.1.254. Make sure that the address of the subnet mask is 255.255.255.0. If necessary, the Default Gateway data should be at 192.168.1.1. To verify these settings, perform the following steps:

**Windows 2000, or XP Users:**

1. Click on Windows **Start** > click on **Run** > input **cmd** > click on **OK** button.
2. At the DOS prompt, type ipconfig/all.
3. Check the IP Address, Subnet Mask, Default Gateway data. Is this data correct? If the data isn't correct. Please input **ipconfig/release** > press **Enter** > input **ipconfig/renew** > press **Enter**.

Possible Solution 3: Verify the connection setting of your Web browser and verify that the HTTP Proxy feature of your Web browser is disabled. Make these verifications so that your Web browser can read configuration pages inside your router. Launch your Web browser.

**Internet Explorer Users:**

1. Click on **Tools** > **Internet Options** > **Connections tab**.
2. Select **never dial a connection**, click on **Apply** button, and then click on **OK** button.
3. Click on **Tools** and then click on **Internet Options**.
4. Click on **Connections** and then click on **LAN Settings**.
5. Make sure none of the check boxes are selected and click on **OK** button.
6. Click on **OK** button.

**Netscape Navigator Users:**

1. Click on **Edit** > **Preferences** > double-click **Advanced** in the Category window.
2. Click on **Proxies** > select **Direct connection to the Internet** > click on **OK** button.
3. Click on **Edit again** and then click on **Preferences**.
4. Under category, double-click on **Advanced** and then click on **Proxies**.
5. Select **Direct connection to the Internet** and click on **OK** button.
6. Click on **OK** button.

3. **Q: Web page hangs, corrupt downloads, or nothing but junk characters is being displayed on the screen. What do I need to do?**

A: Force your NIC to 10Mbps or half duplex mode, and turn off the "Auto-negotiate" feature of your NIC as a temporary measure. (Please look at the Network Control Panel, in your Ethernet Adapter's Advanced Properties tab.)

**4. Q: Why can't I connect to the Web Configuration?**

A: you can remove the proxy server settings in your web browser.

## **9.5 SAPIDO GR-1142 Setup**

**1. Q: Why does SAPIDO GR-1142's setup page shut down unexpectedly?**

A: If one of the pages appears incompletely in SAPIDO GR-1142 's setup pages, please click on Logout item on the Main Menu before shutting it down. Don't keep it working. Then, close Internet browser and open it again for going back to the previous page.

**2. Q: I don't know how to configure DHCP.**

A: DHCP is commonly used in the large local network. It allows you to manage and distribute IP addresses from 2 to 254 throughout your local network via SAPIDO GR-1142 . Without DHCP, you would have to configure each computer separately. It's very troublesome. Please Open **Internet browser** > Input **192.168.1.1 in the website blank field** > Select **DHCP Server** under the **IP Config Menu**. For more information, please refer to 3.3.2 (Router Mode) or 4.3.1 (AP Mode).

**3. Q: How do I upgrade the firmware of SAPIDO GR-1142 ?**

A: Periodically, a new Flash Code is available for SAPIDO GR-1142 on your product supplier's website. Ideally, you should update SAPIDO GR-1142 's Flash Code using **Firmware Upgrade** on the **System Management** menu of SAPIDO GR-1142 Settings.

**4. Q: Why is that I can ping to outside hosts, but cannot access Internet websites?**

A: Check the DNS server settings on your PC. You should get the DNS servers settings from your ISP. If your PC is running a DHCP client, remove any DNS IP address setting. As the router assign the DNS settings to the DHCP-client-enabled PC.

**5. Q: SAPIDO GR-1142 couldn't save the setting after click on Apply button?**

A: SAPIDO GR-1142 will start to run after the setting finished applying, but the setting isn't written into memory. Here we suggest if you want to make sure the setting

would be written into memory, please reboot the device via **Reboot** under **System Management** directory.

## 9.6 Wireless LAN

### 1. Q: Why couldn't my wireless notebook work on-line after checking?

A: Generally, Wireless networks can sometimes be very complicated to set up, particularly if you're dealing with encryption and products from different vendors. Any number of variables can keep your workstations from talking to each other. Let's go over some of more common ones.

For starters, verify that your router and your workstation are using the same SSID descriptions. SSID acts as a password when a mobile device tries to connect to the wireless network. The SSID also differentiates one WLAN from another, so all access points and all devices attempting to connect to a specific WLAN must use the same SSID. A workstation will not be permitted to connect to the network unless it can provide this unique identifier. This is similar to the function of your network's Workgroup or Domain name.

When you're experiencing conductivity problems, it is always best to keep things simple. So next you are going to do is that, please disable any WEP encryption you might have configured.

Successful implementation of encryption also includes the use of a shared key. A HEX key is the most common, but other formats are also used. This key identifies the workstation to the router as a trusted member of this network. Different manufacturers can implement this key technology in ways that might prevent them from working correctly with another vendor's products. So pay attention to detail is going to be the key to a successful installation.

Next make sure the router and the NIC are configured to use the same communications channel. There are normally 11 of them, and the default channel can also vary from vendor to vendor. You might also want to confirm that the router has DHCP services enabled and an address pool configured. If not, the NIC won't be able to pick up an IP address. I have run across a few access points that offer DHCP services but do not assign all of the needed IP information to the NIC. As a result, I was able to connect to the network, but could not browse the web. The point is, don't assume anything. Verify for yourself that all of the required settings are being received by the workstation.

Finally, you might want to keep the system you're trying to configure in the same room as the router, at least during the initial configuration, in order to minimize potential interference from concrete walls or steel beams.

**2. Q: My PC can't locate the Wireless Access Point.**

A: Check the following:

- Your PC is set to Infrastructure Mode. (Access Points are always in Infrastructure Mode.)
- The SSID on your PC and the Wireless Access Point are the same. Remember that the SSID is case-sensitive. So, for example "Workgroup" does NOT match "workgroup".
- Both your PC and the Wireless Access Point must have the same setting for WEP. The default setting for the Wireless Router is disabled, so your wireless station should also have WEP disabled.
- If WEP is enabled on the Wireless Router, your PC must have WEP enabled, and the key must match.
- If the Wireless Router's Wireless screen is set to Allow LAN access to selected Wireless Stations only, then each of your Wireless stations must have been selected, or access will be blocked.
- To see if radio interference is causing a problem, see if connection is possible when close to the Wireless Access Point. Remember that the connection range can be as little as 100 feet in poor environments.

**3. Q: Wireless connection speed is very slow.**

A: The wireless system will connect at highest possible speed, depending on the distance and the environment. To obtain the highest possible connection speed, you can experiment with following:

- Access Point location: Try adjusting the location and orientation of the Access Point.
- Wireless Channel: If interference is the problem, changing to another channel may show a marked improvement.
- Radio Interference: Other devices may be causing interference. You can experiment by switching other devices off, and see if this helps. Any "noisy" devices should be shielded or relocated.
- RF Shielding: Your environment may tend to block transmission between the wireless stations. This will mean high access speed is only possible when close to the Access Point.

**4. Q: Some applications do not run properly when using the Wireless Router.**

A: The Wireless Router processes the data passing through it, so it is not transparent. Use the Special Application feature to allow the use of Internet applications which do not function correctly. If this does solve the problem, you can use the DMZ function. This should work with almost every application, but:

- It is a security risk, since the firewall is disabled.
- Only one (1) PC can use this feature.

**5. Q: I can't connect to the Wireless Router to configure it.**

A: Check the following:

- The Wireless Router is properly installed, LAN connections are OK, and it is powered ON.
- Make sure that your PC and the Wireless Router are on the same network segment.
- If your PC is set to "Obtain an IP Address automatically" (DHCP client), restart it.
- If your PC uses a Fixed (Static) IP address, make sure that it is using an IP Address within the range 192.168.1.129 to 192.168.1.253 and thus compatible with the Wireless Router's default IP Address of 192.168.1.254. Also, the Network Mask should be set to 255.255.255.0 to match the Wireless Router. In Windows, you can check these settings by using Control Panel ~ Network to check the Properties for the TCP/IP protocol.

**6. Q: The WinXP wireless interface couldn't communicate the WEP with SAPIDO GR-1142's wireless interface.**

A: The default WEP of WinXP is **Authentication Open System - WEP**, but the WEP of SAPIDO GR-1142 is only for **Shared Key - WEP**, it caused both sides couldn't communicate. Please select the WEP of WinXP from Authentication Open System to **Pre-shared Key - WEP**, and then the WEP wireless interface between WinXP and SAPIDO GR-1142 would be communicated.

## **9.7 Support**

**1. Q: What is the maximum number of IP addresses that the XDSL Router will support?**

A: The Router will support to 253 IP addresses with NAT mode.

**5. Q: Is the Router cross-platform compatible?**

A: Any platform that supports Ethernet and TCP/IP is compatible with the Router.

**9.8 Others**

**1. Q: Why does the router dial out for PPPoE mode very often?**

A: Normally some of game, music or anti-virus program will send out packets that trigger the router to dial out, you can close these programs. Or you can set the idle time to 0, then control to dial out manually.

**2. Q: What can I do if there is already a DHCP server in LAN?**

A: If there are two DHCP servers existing on the same network, it may cause conflict and generate trouble. In this situation, we suggest to disable DHCP server in router and configure your PC manually.

**9.9 USB Device**

**1. Q: How many USB devices can be connected to the Product?**

A: SAPIDO GR-1142 has 2 USB ports.

## **Chapter 10    Appendices**

### **10.1    Operating Systems**

1.    Microsoft : Windows 2000, XP, Vista, Windows 7.
2.    Apple : Mac OS X 10.4.7, Leopard and the following related versions.
3.    Linux : Redhat 9, Fedora 6 & 7, Ubuntu 7.04 and the following related versions.

### **10.2    Browsers**

1.    Internet Explorer ver. 6 and 7 and the following related versions.
2.    FireFox ver. 2.0.0.11 and the following related versions.3.
3.    Safari ver. 3.04 and the following related versions.

### **10.3    Communications Regulation Information**

Should any consumers need to learn more information, services and supports, please contact the supplier of your product directly.