

Thank you for purchasing the MSI® **B450M PRO-VDH MAX** motherboard. This User Guide gives information about board layout, component overview, BIOS setup and software installation.

## Contents

<b>Safety Information</b> .....	<b>2</b>
<b>Specifications</b> .....	<b>3</b>
<b>Package contents</b> .....	<b>6</b>
<b>Rear I/O Panel</b> .....	<b>7</b>
LAN Port LED Status Table.....	7
<b>Overview of Components</b> .....	<b>8</b>
CPU Socket .....	9
DIMM Slots.....	10
PCI_E1~3: PCIe Expansion Slots .....	11
JFP1, JFP2: Front Panel Connectors .....	12
SATA1~4: SATA 6Gb/s Connectors.....	12
M2_1: M.2 Slot (Key M) .....	13
ATX_PWR1, CPU_PWR1: Power Connectors.....	13
JUSB1~2: USB 2.0 Connectors .....	14
JUSB3: USB 3.2 Gen1 Connector .....	14
CPU_FAN1, SYS_FAN1~2: Fan Connectors.....	15
JTPM1: TPM Module Connector .....	16
JCI1: Chassis Intrusion Connector.....	16
JAUD1: Front Audio Connector.....	17
JCOM1: Serial Port Connector .....	17
JLPT1: Parallel Port Connector.....	17
JBAT1: Clear CMOS (Reset BIOS) Jumper .....	18
EZ Debug LED: Debug LED indicators.....	18
JRGB1: RGB LED strip connector.....	18
<b>BIOS Setup</b> .....	<b>19</b>
Entering BIOS Setup .....	19
Resetting BIOS .....	20
Updating BIOS.....	20
<b>Software Description</b> .....	<b>21</b>
Installing Windows® 10.....	21
Installing Drivers .....	21
Installing Utilities.....	22

# Safety Information

- The components included in this package are prone to damage from electrostatic discharge (ESD). Please adhere to the following instructions to ensure successful computer assembly.
- Ensure that all components are securely connected. Loose connections may cause the computer to not recognize a component or fail to start.
- Hold the motherboard by the edges to avoid touching sensitive components.
- It is recommended to wear an electrostatic discharge (ESD) wrist strap when handling the motherboard to prevent electrostatic damage. If an ESD wrist strap is not available, discharge yourself of static electricity by touching another metal object before handling the motherboard.
- Store the motherboard in an electrostatic shielding container or on an anti-static pad whenever the motherboard is not installed.
- Before turning on the computer, ensure that there are no loose screws or metal components on the motherboard or anywhere within the computer case.
- Do not boot the computer before installation is completed. This could cause permanent damage to the components as well as injury to the user.
- If you need help during any installation step, please consult a certified computer technician.
- Always turn off the power supply and unplug the power cord from the power outlet before installing or removing any computer component.
- Keep this user guide for future reference.
- Keep this motherboard away from humidity.
- Make sure that your electrical outlet provides the same voltage as is indicated on the PSU, before connecting the PSU to the electrical outlet.
- Place the power cord such a way that people can not step on it. Do not place anything over the power cord.
- All cautions and warnings on the motherboard should be noted.
- If any of the following situations arises, get the motherboard checked by service personnel:
  - Liquid has penetrated into the computer.
  - The motherboard has been exposed to moisture.
  - The motherboard does not work well or you can not get it work according to user guide.
  - The motherboard has been dropped and damaged.
  - The motherboard has obvious sign of breakage.
- Do not leave this motherboard in an environment above 60°C (140°F), it may damage the motherboard.

# Specifications

<b>CPU</b>	Supports 1st, 2nd and 3rd Gen AMD Ryzen™/ Ryzen™ with Radeon™ Vega Graphics and 2nd Gen AMD Ryzen™ with Radeon™ Graphics/ Athlon™ with Radeon™ Vega Graphics Desktop Processors for Socket AM4
<b>Chipset</b>	AMD® B450 chipset
<b>Memory</b>	<ul style="list-style-type: none"> <li>• 4x DDR4 memory slots, support up to 64GB*               <ul style="list-style-type: none"> <li>▪ Supports 1866/ 2133/ 2400/ 2667Mhz (by JEDEC)</li> <li>▪ Supports 2667/ 2800/ 2933/ 3000/ 3066/ 3200/ 3466 MHz (by A-XMP OC MODE)</li> </ul> </li> <li>• Dual channel memory architecture</li> <li>• Supports ECC UDIMM memory (non-ECC mode)</li> <li>• Support non-ECC UDIMM memory</li> </ul> <p>* Please refer <a href="http://www.msi.com">www.msi.com</a> for more information on compatible memory.</p>
<b>Expansion Slots</b>	<ul style="list-style-type: none"> <li>• 1x PCIe 3.0 x16 slot               <ul style="list-style-type: none"> <li>▪ 1st, 2nd and 3rd Gen AMD Ryzen™ support x16 mode</li> <li>▪ Ryzen™ with Radeon™ Vega Graphics and 2nd Gen AMD Ryzen™ with Radeon™ Graphics support x8 mode</li> <li>▪ Athlon™ with Radeon™ Vega Graphics support x4 mode</li> </ul> </li> <li>• 2x PCIe 2.0 x1 slots</li> </ul>
<b>Onboard Graphics</b>	<ul style="list-style-type: none"> <li>• 1x VGA port, supports a maximum resolution of 2048x1280@60Hz, 1920x1200@60Hz*</li> <li>• 1x DVI-D port, supports a maximum resolution of 1920x1200@60Hz*</li> <li>• 1x HDMI™ 1.4 port, supports a maximum resolution of 4096x2160 @30Hz, 2560x1600 @60Hz*</li> </ul> <p>* Only support when using Ryzen™ with Radeon™ Vega Graphics, 2nd Gen AMD Ryzen™ with Radeon™ Graphics and Athlon™ with Radeon™ Vega Graphics processors * Maximum shared memory of 2048 MB</p>
<b>Storage</b>	<p>AMD® B450 Chipset</p> <ul style="list-style-type: none"> <li>• 4x SATA 6Gb/s ports               <ul style="list-style-type: none"> <li>▪ Supports RAID 0, RAID1 and RAID 10</li> </ul> </li> <li>• 1x M.2 slot (Key M)               <ul style="list-style-type: none"> <li>▪ Supports PCIe 3.0 x4 (1st, 2nd and 3rd Gen AMD Ryzen™/ Ryzen™ with Radeon™ Vega Graphics and 2nd Gen AMD Ryzen™ with Radeon™ Graphics) or PCIe 3.0 x2 (Athlon™ with Radeon™ Vega Graphics) and SATA 6Gb/s</li> <li>▪ Supports 2242/ 2260 /2280 storage devices</li> </ul> </li> </ul>

Continued on next page

Continued from previous page

<b>Audio</b>	Realtek® ALC892 Codec <ul style="list-style-type: none"><li>• 7.1-Channel High Definition Audio</li></ul>
<b>LAN</b>	1x Realtek® 8111H Gigabit LAN controller
<b>USB</b>	AMD® B450 Chipset <ul style="list-style-type: none"><li>• 2x USB 3.2 Gen1 (SuperSpeed USB) ports through the internal USB 3.2 Gen1 connector</li><li>• 8x USB 2.0 (High-speed USB) ports (4 ports on the back panel, 4 ports available through the internal USB connectors)</li><li>• AMD® processor</li><li>• 4x USB 3.2 Gen1 (SuperSpeed USB) Type-A ports on the back panel</li></ul>
<b>I/O Controller</b>	NUVOTON 6795D Controller Chip
<b>Hardware Monitor</b>	<ul style="list-style-type: none"><li>• CPU/System temperature detection</li><li>• CPU/System fan speed detection</li><li>• CPU/System fan speed control</li></ul>
<b>Form Factor</b>	<ul style="list-style-type: none"><li>• m-ATX Form Factor</li><li>• 9.6 in. x 9.6 in. (24.4 cm x 24.4 cm)</li></ul>
<b>BIOS Features</b>	<ul style="list-style-type: none"><li>• 1x 256 Mb flash</li><li>• UEFI AMI BIOS</li><li>• ACPI 6.1, SM BIOS 2.8</li><li>• Multi-language</li></ul>
<b>Back Panel Connectors</b>	<ul style="list-style-type: none"><li>• 1x PS/2 keyboard/ mouse combo port</li><li>• 4x USB 2.0 Type-A ports</li><li>• 1x VGA port</li><li>• 1x DVI-D port</li><li>• 1x HDMI™ port</li><li>• 4x USB 3.2 Gen1 Type-A ports</li><li>• 1x LAN (RJ45) port</li><li>• 3x audio jacks</li></ul>
<b>Internal Connectors</b>	<ul style="list-style-type: none"><li>• 1x 24-pin ATX main power connector</li><li>• 1x 8-pin ATX 12V power connector</li><li>• 4x SATA 6Gb/s connectors</li><li>• 2x USB 2.0 connectors (supports additional 4 USB 2.0 ports)</li><li>• 1x USB 3.2 Gen1 connector (supports additional 2 USB 3.2 Gen1 ports)</li></ul>

Continued on next page

Continued from previous page

<b>Internal Connectors</b>	<ul style="list-style-type: none"><li>• 1x 4-pin CPU fan connector</li><li>• 2x 4-pin system fan connectors</li><li>• 1x Front panel audio connector</li><li>• 2x Front panel connectors</li><li>• 1x TPM module connector</li><li>• 1x Chassis Intrusion connector</li><li>• 1x Serial port connector</li><li>• 1x Parallel port connector</li><li>• 1x RGB LED strip connector</li><li>• 1x Clear CMOS jumper</li></ul>
<b>Software</b>	<ul style="list-style-type: none"><li>• Drivers</li><li>• APP MANAGER</li><li>• SUPER CHARGER</li><li>• COMMAND CENTER</li><li>• LIVE UPDATE 6</li><li>• MYSTIC LIGHT</li><li>• SMART TOOL</li><li>• X-BOOST</li><li>• RAMDISK</li><li>• Norton™ Security</li><li>• Google Chrome™, Google Toolbar, Google Drive</li><li>• CPU-Z MSI GAMING</li></ul>

# Package contents

Please check the contents of your motherboard package. It should contain:

- Motherboard
- Driver DVD
- Quick Installation Guide
- I/O Shielding
- SATA 6G Cable x2
- Case Badge
- Product registration card
- M.2 Screw x1

 **Important**

*If any of the above items are damaged or missing, please contact your retailer.*

## Rear I/O Panel

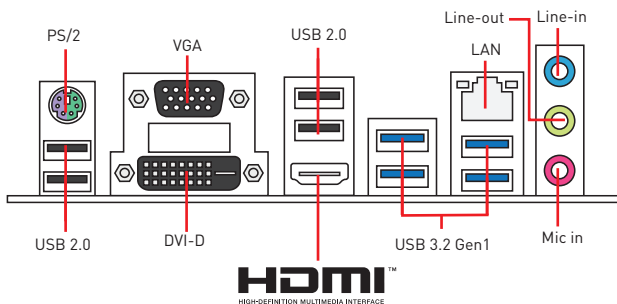

## LAN Port LED Status Table

Link/ Activity LED			Speed LED	
Status	Description		Status	Description
Off	No link	Off	10 Mbps connection	
Yellow	Linked	Green	100 Mbps connection	
Blinking	Data activity	Orange	1 Gbps connection	

## Audio 7.1-channel Configuration

To configure 7.1-channel audio, you have to connect front audio I/O module to JAUD1 connector and follow the below steps.

1. Click on the **Realtek HD Audio Manager > Advanced Settings** to open the dialog below.

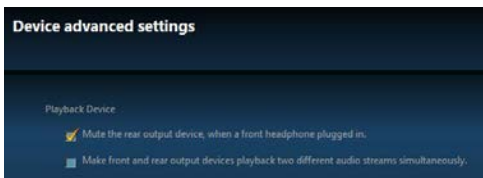

2. Select **Mute the rear output device, when a front headphone plugged in.**
3. Plug your speakers to audio jacks on rear and front I/O panel. When you plug into a device at an audio jack, a dialogue window will pop up asking you which device is current connected.

# Overview of Components

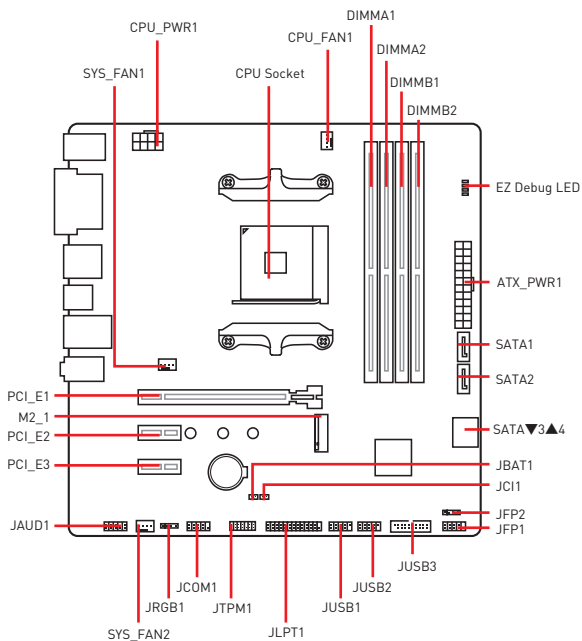

## CPU Socket

Please install the CPU into the CPU socket as shown below.

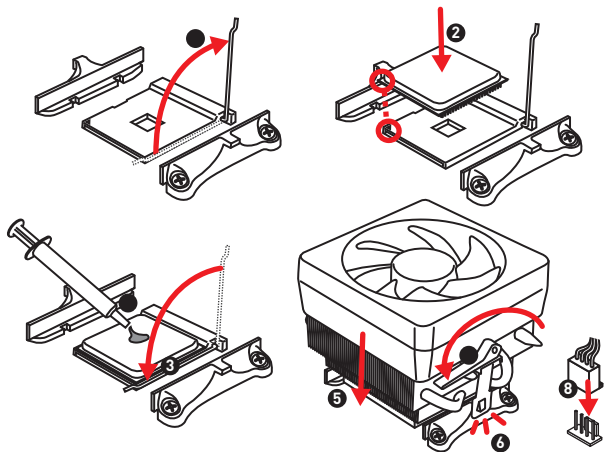

### Important

- When changing the processor, the system configuration could be cleared and reset BIOS to default values due to the AM4 processor's architecture.
- Always unplug the power cord from the power outlet before installing or removing the CPU.
- When installing a CPU, always remember to install a CPU heatsink. A CPU heatsink is necessary to prevent overheating and maintain system stability.
- Confirm that the CPU heatsink has formed a tight seal with the CPU before booting your system.
- Overheating can seriously damage the CPU and motherboard. Always make sure the cooling fans work properly to protect the CPU from overheating. Be sure to apply an even layer of thermal paste (or thermal tape) between the CPU and the heatsink to enhance heat dissipation.
- If you purchased a separate CPU and heatsink/ cooler, Please refer to the documentation in the heatsink/ cooler package for more details about installation.

## DIMM Slots

Please install the memory module into the DIMM slot as shown below.

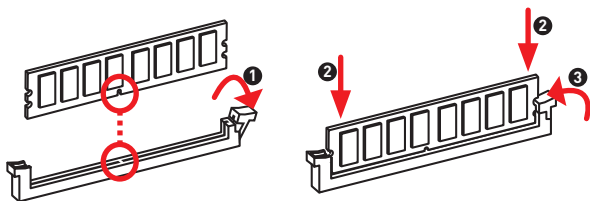

## Memory module installation recommendation

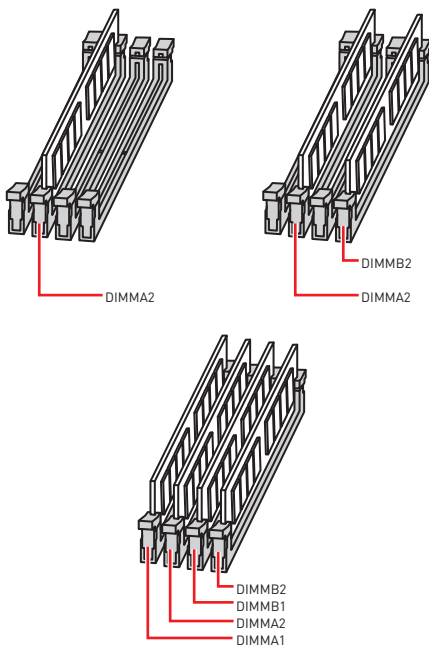

### **Important**

- Always insert memory modules in the DIMMA2 slot first.
- Due to chipset resource usage, the available capacity of memory will be a little less than the amount of installed.
- Based on processor specification, the Memory DIMM voltage below 1.35V is suggested to protect the processor.
- Due to AM4 CPU/memory controller official specification limitation, the frequency of memory modules may operate lower than the marked value under the default state. Please refer [www.msi.com](http://www.msi.com) for more information on compatible memory.

## PCI\_E1~3: PCIe Expansion Slots

Processors \ Slots	1st, 2nd and 3rd Gen AMD Ryzen™	Ryzen™ with Radeon™ Vega Graphics and 2nd Gen AMD Ryzen™ with Radeon™ Graphics	Athlon™ with Radeon™ Vega Graphics
	PCI_E1	PCIe 3.0 x16	PCIe 3.0 x8
PCI_E2	PCIe 2.0 x1	PCIe 2.0 x1	PCIe 2.0 x1
PCI_E3	PCIe 2.0 x1	PCIe 2.0 x1	PCIe 2.0 x1

### **Important**

- When adding or removing expansion cards, always turn off the power supply and unplug the power supply power cable from the power outlet. Read the expansion card's documentation to check for any necessary additional hardware or software changes.
- If you install a large and heavy graphics card, you need to use a tool such as MSI Gaming Series Graphics Card Bolster to support its weight to prevent deformation of the slot.

## JFP1, JFP2: Front Panel Connectors

These connectors connect to the switches and LEDs on the front panel.

	1	HDD LED +	2	Power LED +
	3	HDD LED -	4	Power LED -
	5	Reset Switch	6	Power Switch
	7	Reset Switch	8	Power Switch
	9	Reserved	10	No Pin

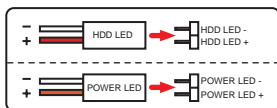
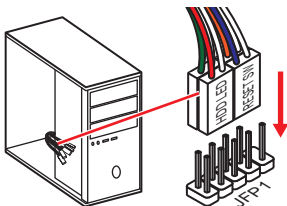

	1	Speaker -	2	Buzzer +
	3	Buzzer -	4	Speaker +

## SATA1~4: SATA 6Gb/s Connectors

These connectors are SATA 6Gb/s interface ports. Each connector can connect to one SATA device.

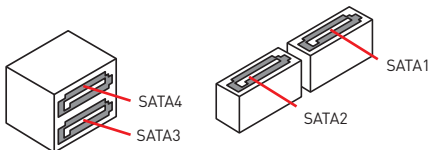

### Important

- Please do not fold the SATA cable at a 90-degree angle. Data loss may result during transmission otherwise.
- SATA cables have identical plugs on either sides of the cable. However, it is recommended that the flat connector be connected to the motherboard for space saving purposes.

## M2\_1: M.2 Slot (Key M)

Please install the M.2 solid-state drive (SSD) into the M.2 slot as shown below.

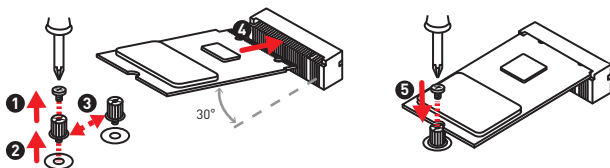

## ATX\_PWR1, CPU\_PWR1: Power Connectors

These connectors allow you to connect an ATX power supply.

<p>ATX_PWR1</p>	1	+3.3V	13	+3.3V
	2	+3.3V	14	-12V
	3	Ground	15	Ground
	4	+5V	16	PS-ON#
	5	Ground	17	Ground
	6	+5V	18	Ground
	7	Ground	19	Ground
	8	PWR OK	20	Res
	9	5VSB	21	+5V
	10	+12V	22	+5V
	11	+12V	23	+5V
	12	+3.3V	24	Ground

<p>CPU_PWR1</p>	1	Ground	5	+12V
	2	Ground	6	+12V
	3	Ground	7	+12V
	4	Ground	8	+12V

### Important

Make sure that all the power cables are securely connected to a proper ATX power supply to ensure stable operation of the motherboard.

## JUSB1~2: USB 2.0 Connectors

These connectors allow you to connect USB 2.0 ports on the front panel.

	1	VCC	2	VCC
	3	USB0-	4	USB1-
	5	USB0+	6	USB1+
	7	Ground	8	Ground
	9	No Pin	10	NC

### **Important**

- Note that the VCC and Ground pins must be connected correctly to avoid possible damage.
- In order to recharge your iPad, iPhone and iPod through USB ports, please install MSI® SUPER CHARGER utility.

## JUSB3: USB 3.2 Gen1 Connector

This connector allows you to connect USB 3.2 Gen1 ports on the front panel.

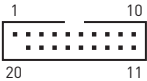
	1	Power	11	USB2.0+
	2	USB3_RX_DN	12	USB2.0-
	3	USB3_RX_DP	13	Ground
	4	Ground	14	USB3_TX_C_DP
	5	USB3_TX_C_DN	15	USB3_TX_C_DN
	6	USB3_TX_C_DP	16	Ground
	7	Ground	17	USB3_RX_DP
	8	USB2.0-	18	USB3_RX_DN
	9	USB2.0+	19	Power
	10	NC	20	No Pin

### **Important**

Note that the Power and Ground pins must be connected correctly to avoid possible damage.

## CPU\_FAN1, SYS\_FAN1~2: Fan Connectors

Fan connectors can be classified as PWM (Pulse Width Modulation) Mode or DC Mode. PWM Mode fan connectors provide constant 12V output and adjust fan speed with speed control signal. DC Mode fan connectors control fan speed by changing voltage. When you plug a 3-pin (Non-PWM) fan to a fan connector in PWM mode, the fan speed will always maintain at 100%, which might create a lot of noise. You can follow the instruction below to adjust the fan connector to PWM or DC Mode.

**Default PWM Mode fan connector**



CPU\_FAN1

**Default DC Mode fan connector**



SYS\_FAN1/ 2

### Switching fan mode and adjusting fan speed

You can switch between PWM mode and DC mode and adjust fan speed in **BIOS > HARDWARE MONITOR**.

Select **PWM** mode or **DC** mode



There are gradient points of the fan speed that allow you to adjust fan speed in relation to CPU temperature.

### **Important**

Make sure fans are working properly after switching the PWM/ DC mode.

### Pin definition of fan connectors

PWM Mode pin definition			
1	Ground	2	+12V
3	Sense	4	Speed Control Signal

DC Mode pin definition			
1	Ground	2	Voltage Control
3	Sense	4	NC

## JTPM1: TPM Module Connector

This connector is for TPM (Trusted Platform Module). Please refer to the TPM security platform manual for more details and usages.

	1	LPC Clock	2	3V Standby power
	3	LPC Reset	4	3.3V Power
	5	LPC address & data pin0	6	Serial IRQ
	7	LPC address & data pin1	8	5V Power
	9	LPC address & data pin2	10	No Pin
	11	LPC address & data pin3	12	Ground
	13	LPC Frame	14	Ground

## JCI1: Chassis Intrusion Connector

This connector allows you to connect the chassis intrusion switch cable.



Normal  
(default)



Trigger the chassis  
intrusion event

### Using chassis intrusion detector

1. Connect the **JCI1** connector to the chassis intrusion switch/ sensor on the chassis.
2. Close the chassis cover.
3. Go to **BIOS > SETTINGS > Security > Chassis Intrusion Configuration**.
4. Set **Chassis Intrusion** to **Enabled**.
5. Press **F10** to save and exit and then press the **Enter** key to select **Yes**.
6. Once the chassis cover is opened again, a warning message will be displayed on screen when the computer is turned on.

### Resetting the chassis intrusion warning

1. Go to **BIOS > SETTINGS > Security > Chassis Intrusion Configuration**.
2. Set **Chassis Intrusion** to **Reset**.
3. Press **F10** to save and exit and then press the **Enter** key to select **Yes**.

## JAUD1: Front Audio Connector

This connector allow you to connect audio jacks on the front panel.

	1	MIC L	2	Ground
	3	MIC R	4	NC
	5	Head Phone R	6	MIC Detection
	7	SENSE_SEND	8	No Pin
	9	Head Phone L	10	Head Phone Detection

## JCOM1: Serial Port Connector

This connector allows you to connect the optional serial port with bracket.

	1	DCD	2	SIN
	3	SOUT	4	DTR
	5	Ground	6	DSR
	7	RTS	8	CTS
	9	RI	10	No Pin

## JLPT1: Parallel Port Connector

This connector allows you to connect the optional parallel port with bracket.

1	RSTB#	2	AFD#	3	PRND0
4	ERR#	5	PRND1	6	PINIT#
7	PRND2	8	LPT_SLIN#	9	PRND3
10	Ground	11	PRND4	12	Ground
13	PRND5	14	Ground	15	PRND6
16	Ground	17	PRND7	18	Ground
19	ACK#	20	Ground	21	BUSY
22	Ground	23	PE	24	Ground
25	SLCT	26	No Pin		

## JBAT1: Clear CMOS (Reset BIOS) Jumper

There is CMOS memory onboard that is external powered from a battery located on the motherboard to save system configuration data. If you want to clear the system configuration, set the jumpers to clear the CMOS memory.



Keep Data  
(default)



Clear CMOS/ Reset  
BIOS

## Resetting BIOS to default values

1. Power off the computer and unplug the power cord.
2. Use a jumper cap to short JBAT1 for about 5-10 seconds.
3. Remove the jumper cap from JBAT1.
4. Plug the power cord and power on the computer.

## EZ Debug LED: Debug LED indicators

These LEDs indicate the status of the motherboard.

- CPU** - indicates CPU is not detected or fail.
- DRAM** - indicates DRAM is not detected or fail.
- VGA** - indicates GPU is not detected or fail.
- BOOT** - indicates booting device is not detected or fail.

## JRGB1: RGB LED strip connector

This connector allows you to connect the 5050 RGB LED strip.

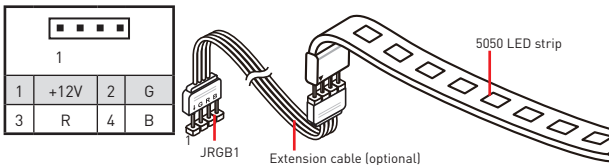

### **Important**

- This connector supports 5050 RGB multi-color LED strips (12V/G/R/B) with the maximum power rating of 3A (12V). Please keeping the LED strip shorter than 2 meters to prevent dimming.
- Always turn off the power supply and unplug the power cord from the power outlet before installing or removing the RGB LED strip.
- Please use MSI's software to control the extended LED strip.

# BIOS Setup

The default settings offer the optimal performance for system stability in normal conditions. You should **always keep the default settings** to avoid possible system damage or failure booting unless you are familiar with BIOS.

## **Important**

- *BIOS items are continuous update for better system performance. Therefore, the description may be slightly different from the latest BIOS and should be held for reference only. You could also refer to the **HELP** information panel for BIOS item description.*
- *The pictures in this chapter are for reference only and may vary from the product you purchased.*
- *The BIOS items will vary with the processor.*

## Entering BIOS Setup

Press **Delete** key, when the **Press DEL key to enter Setup Menu, F11 to enter Boot Menu** message appears on the screen during the boot process.

### Function key

- F1:** General Help
- F2:** Add/ Remove a favorite item
- F3:** Enter Favorites menu
- F4:** Enter CPU Specifications menu
- F5:** Enter Memory-Z menu
- F6:** Load optimized defaults
- F7:** Switch between Advanced mode and EZ mode
- F8:** Load Overclocking Profile
- F9:** Save Overclocking Profile
- F10:** Save Change and Reset\*
- F12:** Take a screenshot and save it to USB flash drive (FAT/ FAT32 format only).

\* When you press F10, a confirmation window appears and it provides the modification information. Select between Yes or No to confirm your choice.

## Resetting BIOS

You might need to restore the default BIOS setting to solve certain problems. There are several ways to reset BIOS:

- Go to BIOS and press **F6** to load optimized defaults.
- Short the **Clear CMOS** jumper on the motherboard.



Please refer to the **Clear CMOS** jumper section for resetting BIOS.

## Updating BIOS

### Updating BIOS with M-FLASH

Before updating:

Please download the latest BIOS file that matches your motherboard model from MSI website. And then save the BIOS file into the USB flash drive.

Updating BIOS:

1. Press Del key to enter the BIOS Setup during POST.
2. Insert the USB flash drive that contains the update file into the computer.
3. Select the **M-FLASH** tab and click on **Yes** to reboot the system and enter the flash mode.
4. Select a BIOS file to perform the BIOS update process.
5. After the flashing process is 100% completed, the system will reboot automatically.

### Updating the BIOS with Live Update 6

Before updating:

Make sure the LAN driver is already installed and the Internet connection is set properly.

Updating BIOS:

1. Install and launch MSI LIVE UPDATE 6.
2. Select **BIOS Update**.
3. Click on **Scan** button.
4. Click on **Download** icon to download and install the latest BIOS file.
5. Click **Next** and choose **In Windows mode**. And then click **Next** and **Start** to start updating BIOS.
6. After the flashing process is 100% completed, the system will restart automatically.

# Software Description

Please download and update the latest utilities and drivers at [www.msi.com](http://www.msi.com)

## Installing Windows® 10

1. Power on the computer.
2. Insert the Windows® 10 disc into your optical drive.
3. Press the **Restart** button on the computer case.
4. Press **F11** key during the computer POST (Power-On Self Test) to get into Boot Menu.
5. Select your optical drive from the Boot Menu.
6. Press any key when screen shows **Press any key to boot from CD or DVD...** message.
7. Follow the instructions on the screen to install Windows® 10.

## Installing Drivers

1. Start up your computer in Windows® 10.
2. Insert MSI® Driver Disc into your optical drive.
3. The installer will automatically appear and it will find and list all necessary drivers.
4. Click **Install** button.
5. The software installation will then be in progress, after it has finished it will prompt you to restart.
6. Click **OK** button to finish.
7. Restart your computer.

## Installing Utilities

Before you install utilities, you must complete drivers installation.

1. Insert MSI® Driver Disc into your optical drive.
2. The installer will automatically appear.
3. Click **Utilities** tab.
4. Select the utilities you want to install.
5. Click **Install** button.
6. The utilities installation will then be in progress, after it has finished it will prompt you to restart.
7. Click **OK** button to finish.
8. Restart your computer.